

SCF47B-300-S2R0B012J

Aliases (UALF47BS012J00)

KEMET, SCF Three Phase, AC Line Filters, Common Mode, 1.2 mH

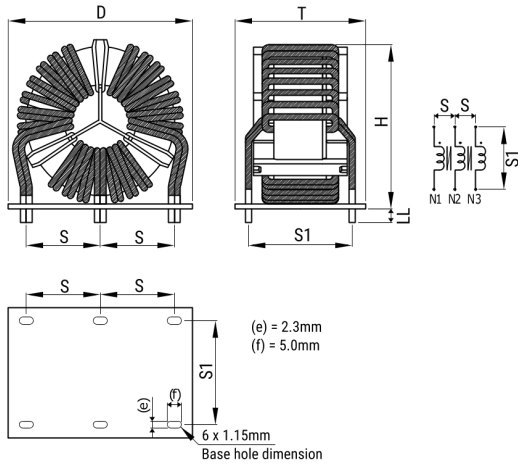

Click [here](#) for the 3D model.

Dimensions

D	63mm MAX
T	45mm MAX
H	65mm MAX
LL	5.1mm +/-1mm
S	25mm NOM
S1	35mm NOM
Wire Size	2.0mm x 2P

Packaging Specifications

Packaging	Tray
Packaging Quantity	27
Component Weight	238.5 g

General Information

Series	SCF Three Phase
Style	Through-Hole
Features	High Impedance, Space Saving
RoHS	Yes
Notes	Lead Spacing (S/S1) Are For Reference Only.
Miscellaneous	Temperature Rise Maximum: 50 K.
Core	Nanocrystal

Specifications

Voltage AC	250 VAC
Inductance	1.2 mH (100 kHz)
Current	30 A
Temperature Range	-25/+105°C
DC Resistance	2.4 mOhms

Statements of suitability for certain applications are based on our knowledge of typical operating conditions for such applications, but are not intended to constitute - and we specifically disclaim - any warranty concerning suitability for a specific customer application or use. This information is intended for use only by customers who have the requisite experience and capability to determine the correct products for their application. Any technical advice inferred from this information or otherwise provided by us with reference to the use of our products is given gratis, and we assume no obligation or liability for the advice given or results obtained.