

LUXEON C Color Line

Multiple colors, a single focal length

The LUXEON C Color Line is an optically advanced portfolio of Color and White LEDs. Designed for flawless color mixing, LUXEON C Color Line has one focal length for all colors, which provides consistent radiation patterns from secondary optics and maximizes optical efficiency. With low dome design, it keeps effective source size small while still improving light extraction. Designed for smooth color mixing and maximum punch, LUXEON C Color Line is the optimal LED solution for architecture, entertainment and emergency vehicle lighting applications.

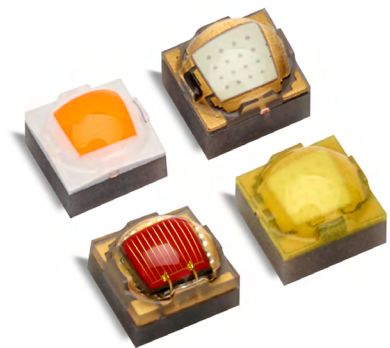

FEATURES AND BENEFITS

One focal length allows flawless color mixing, maximum optical efficiency and removes halos

Low dome design eliminates trade-offs between flux and source size

Hot tested—removes guesswork for designers

Industry's lowest thermal resistance means greater light output and lower heatsink costs

Small symmetrical 2x2mm² package enables dense packing and limits the impact of rotation during reflow

PRIMARY APPLICATIONS

Spotlights

Wall Wash

Floodlights

Landscape Lighting

[More...](#)

Table of Contents

General Product Information	2
Product Test Conditions	2
Part Number Nomenclature	2
Lumen Maintenance	2
Environmental Compliance	2
Performance Characteristics	3
Product Selection Guide	3
Optical Characteristics	4
Electrical and Thermal Characteristics	5
Absolute Maximum Ratings	5
Characteristic Curves	6
Spectral Power Distribution Characteristics	6
Light Output Characteristics	9
Forward Current Characteristics	16
Radiation Pattern Characteristics	19
Product Bin and Labeling Definitions	22
Decoding Product Bin Labeling	22
Luminous Flux Bins	23
Radiometric Power Bins	24
Color Bin Definitions	25
Peak Wavelength Bins	28
Dominant Wavelength Bins	28
Forward Voltage Bins	29
Mechanical Dimensions	29
Reflow Soldering Guidelines	30
JEDEC Moisture Sensitivity	30
Solder Pad Design	31
Packaging Information	31
Pocket Tape Dimensions	31
Reel Dimensions	32

General Product Information

Product Test Conditions

LUXEON C Color Line LEDs are tested and binned with a DC drive current of 350mA at a junction temperature, T_j , of 85°C.

Part Number Nomenclature

Part numbers for LUXEON C Colors follow the convention below:

L 1 C 1 – **A A A** 1 0 0 0 0 0 0 0 0 0

Where:

A A A – designates color (FRD=Far Red, DRD=Deep Red, RED=Red, RNG=Red-Orange, AMB=Amber, PCA=PC Amber, MNT=Mint, LME=Lime, GRN=Green, CYN=Cyan, BLU=Blue, PCB=PC Blue, RYL=Royal Blue, VLT=Violet)

Therefore, the following part number is used for a LUXEON C Red LED:

L 1 C 1 – **R E D** 1 0 0 0 0 0 0 0 0 0

Part numbers for LUXEON C White follow the convention below:

L 1 C 1 – **A A B B** 0 0 0 0 0 0 0 0 0 0

Where:

A A – designates nominal CCT (22=2200K, 27= 2700K, 30=3000K, 35=3500K, 40=4000K, 50=5000K, 57=5700K, 65=6500K)
B B – designates minimum CRI (70=70CRI, 80=80CRI, 90=90CRI)

Therefore, the following part number is used for a LUXEON C White 4000K 70CRI LED:

L 1 C 1 – **4 0 7 0** 0 0 0 0 0 0 0 0 0 0

Lumen Maintenance

Please contact your local Sales Representative or Lumileds Technical Solutions Manager for more information about the long-term performance of this product.

Environmental Compliance

Lumileds LLC is committed to providing environmentally friendly products to the solid-state lighting market. LUXEON C is compliant to the European Union directives on the restriction of hazardous substances in electronic equipment, namely the RoHS Directive 2011/65/EU and REACH Regulation (EC) 1907/2006. Lumileds LLC will not intentionally add the following restricted materials to its products: lead, mercury, cadmium, hexavalent chromium, polybrominated biphenyls (PBB) or polybrominated diphenyl ethers (PBDE).

Performance Characteristics

Product Selection Guide

Table 1a. Product performance of LUXEON C Colors at 350mA, T_j=85°C.

COLOR	DOMINANT OR PEAK WAVELENGTH ^[1] (nm)		LUMINOUS FLUX (lm) OR RADIOMETRIC POWER ^[2] (mW)		PART NUMBER
	MINIMUM	MAXIMUM	MINIMUM	TYPICAL	
Far Red	720	750	190	340	L1C1-FRD1000000000
Deep Red	655	675	280	380	L1C1-DRD1000000000
Red	624	634	35	49	L1C1-RED1000000000
Red-Orange	614	624	45	60	L1C1-RNG1000000000
Amber	585	600	20	30	L1C1-AMB1000000000
PC Amber	-	-	80	110	L1C1-PCA1000000000
Mint	-	-	140	152	L1C1-MNT1000000000
Lime	-	-	125	149	L1C1-LME1000000000
Green	520	540	90	141	L1C1-GRN1000000000
Cyan	490	510	65	100	L1C1-CYN1000000000
Blue	465	485	25	43	L1C1-BLU1000000000
PC Blue	-	-	40	52	L1C1-PCB1000000000
Royal Blue	440	460	480	552	L1C1-RYL1000000000
Violet	420	430	480	595	L1C1-VLT1000000000

Notes for Table 1a:

- Lumileds maintains a tolerance of ±6.5% on luminous flux measurements. PC Amber, Mint, Lime and PC Blue are binned by chromaticity coordinates. Far Red, Deep Red, Royal Blue and Violet are binned by peak wavelength. All other colors are binned by dominant wavelength.
- Far Red, Deep Red, Royal Blue and Violet are binned by radiometric power. All other colors are binned by luminous flux.

Table 1b. Product performance of LUXEON C White at 350mA, T_j=85°C.

COLOR	NOMINAL CCT	MINIMUM CRI ^[1]	LUMINOUS FLUX ^[1] (lm)		TYPICAL LUMINOUS EFFICACY (lm/W)	PART NUMBER
			MINIMUM	TYPICAL		
White	4000K	70	100	116	121	L1C1-40700000000000
	5000K	70	100	117	122	L1C1-50700000000000
	5700K	70	100	118	124	L1C1-57700000000000
	6500K	70	100	119	124	L1C1-65700000000000
	2200K	80	70	85	88	L1C1-22800000000000
	2700K	80	90	94	98	L1C1-27800000000000
	3000K	80	90	102	106	L1C1-30800000000000
	3500K	80	90	108	112	L1C1-35800000000000
	4000K	80	100	113	117	L1C1-40800000000000
	2700K	90	70	82	85	L1C1-27900000000000
	3000K	90	70	86	89	L1C1-30900000000000
	4000K	90	75	95	99	L1C1-40900000000000
	5700K	90	80	93	94	L1C1-57900000000000

Notes for Table 1b:

- Lumileds maintains a tolerance of ±2 on CRI and ±6.5% on luminous flux measurements.

Optical Characteristics

Table 2a. Optical characteristics for LUXEON C Colors at 350mA, T_j=85°C.

COLOR	PART NUMBER	TYPICAL SPECTRAL HALF-WIDTH ^[1] (nm)	TYPICAL TEMPERATURE COEFFICIENT OF DOMINANT OR PEAK WAVELENGTH (nm/°C)	TYPICAL TOTAL INCLUDED ANGLE ^[2]	TYPICAL VIEWING ANGLE ^[3]
Far Red	L1C1-FRD1000000000	20	0.06	175°	162°
Deep Red	L1C1-DRD1000000000	20	0.06	175°	162°
Red	L1C1-RED1000000000	20	0.06	175°	162°
Red-Orange	L1C1-RNG1000000000	20	0.06	175°	162°
Amber	L1C1-AMB1000000000	20	0.06	175°	162°
PC Amber	L1C1-PCA1000000000	80	-0.01	175°	150°
Mint	L1C1-MNT1000000000	80	-0.01	175°	150°
Lime	L1C1-LME1000000000	80	-0.01	175°	145°
Green	L1C1-GRN1000000000	30	0.04	175°	170°
Cyan	L1C1-CYN1000000000	30	0.03	175°	170°
Blue	L1C1-BLU1000000000	20	0.03	175°	170°
PC Blue	L1C1-PCB1000000000	27	0.03	156°	161°
Royal Blue	L1C1-RYL1000000000	20	0.03	175°	165°
Violet	L1C1-VTL1000000000	20	0.03	175°	165°

Notes for Table 2a:

1. Spectral half-width is the spectral bandwidth at 50% of the peak intensity.
2. Total angle at which 90% of total luminous flux is captured.
3. Viewing angle is the off axis angle from the LED centerline where the luminous intensity is ½ of the peak value.

Table 2b. Optical characteristics for LUXEON C White at 350mA, T_j=85°C.

COLOR	PART NUMBER	TYPICAL TOTAL INCLUDED ANGLE ^[1]	TYPICAL VIEWING ANGLE ^[2]
White	L1C1-xxx000000000	170°	150°

Notes for Table 2b:

1. Total angle at which 90% of total luminous flux is captured.
2. Viewing angle is the off axis angle from the LED centerline where the luminous intensity is ½ of the peak value.

Electrical and Thermal Characteristics

Table 3. Electrical and thermal characteristics for LUXE ON C Color Line at 350mA, T_j=85°C.

COLOR	PART NUMBER	FORWARD VOLTAGE ^[1] (V _f)			TYPICAL TEMPERATURE COEFFICIENT OF FORWARD VOLTAGE ^[2] (mV/°C)	TYPICAL THERMAL RESISTANCE—JUNCTION TO SOLDER PAD (°C/W)
		MINIMUM	TYPICAL	MAXIMUM		
Far Red	L1C1-FRD1000000000	1.50	1.90	2.30	-1.7	2.8
Deep Red	L1C1-DRD1000000000	1.50	2.05	2.30	-1.7	2.8
Red	L1C1-RED1000000000	1.75	2.00	2.50	-1.6	2.8
Red-Orange	L1C1-RNG1000000000	1.75	2.05	2.50	-1.6	2.8
Amber	L1C1-AMB1000000000	1.75	2.05	2.50	-2.0	2.8
PC Amber	L1C1-PCA1000000000	2.50	2.75	3.50	-1.7	3.0
Mint	L1C1-MNT1000000000	2.50	2.75	3.50	-2.7	2.8
Lime	L1C1-LME1000000000	2.50	2.75	3.50	-2.7	2.8
Green	L1C1-GRN1000000000	2.50	3.05	3.50	-2.4	3.5
Cyan	L1C1-CYN1000000000	2.50	3.05	3.50	-2.4	3.5
Blue	L1C1-BLU1000000000	2.50	3.08	3.50	-2.6	3.5
PC Blue	L1C1-PCB1000000000	2.50	3.08	3.50	-3.9	3.0
Royal Blue	L1C1-RYL1000000000	2.50	2.75	3.50	-1.7	2.8
Violet	L1C1-VLT1000000000	2.50	2.83	3.50	-1.7	3.8
White	L1C1-xxx000000000	2.50	2.75	3.50	-1.7	2.8

Notes for Table 3:

1. Lumileds maintains a tolerance of ±0.06V on forward voltage measurements.
2. Measured between 25°C and 85°C.

Absolute Maximum Ratings

Table 4. Absolute maximum ratings for LUXEON C Color Line.

PARAMETER	FAR RED AND DEEP RED	RED, RED-ORANGE, AMBER AND PC AMBER	GREEN AND CYAN	BLUE, PC BLUE AND ROYAL BLUE	MINT, LIME, VIOLET AND WHITE
DC Forward Current ^[1, 2]	700mA	1050mA	1050mA	1050mA	1225mA
Peak Pulsed Forward Current ^[1, 3]	875mA	1300mA	1300mA	1300mA	1500mA
LED Junction Temperature ^[1] (DC & Pulse)	135°C	120°C	135°C	135°C	135°C
ESD Sensitivity (ANSI/ESDA/JEDEC JS-001-2012)	Class 3B				
LED Storage Temperature	-40°C to 135°C				
Soldering Temperature	JEDEC 020c 260°C				
Allowable Reflow Cycles	3				
Reverse Voltage (V _{reverse})	LUXEON C LEDs are not designed to be driven in reverse bias				

Notes for Table 4:

1. Proper current derating must be observed to maintain the junction temperature below the maximum allowable junction temperature.
2. Residual periodic variations due to power conversion from alternating current (AC) to direct current (DC), also called "ripple," are acceptable if the following conditions are met:
 - The frequency of the ripple current is 100Hz or higher
 - The average current for each cycle does not exceed the maximum allowable DC forward current
 - The maximum amplitude of the ripple does not exceed the maximum peak pulsed forward current
3. At 10% duty cycle with pulse width of 10ms.

Characteristic Curves

Spectral Power Distribution Characteristics

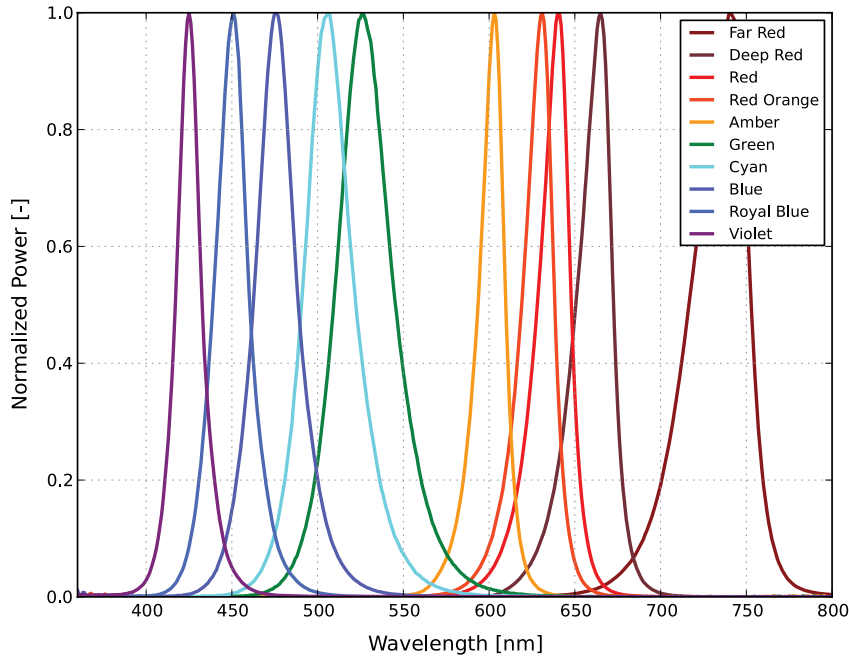

Figure 1a. Typical normalized power vs. wavelength for LUXEON C Direct Colors at 350mA, $T_j=85^{\circ}\text{C}$.

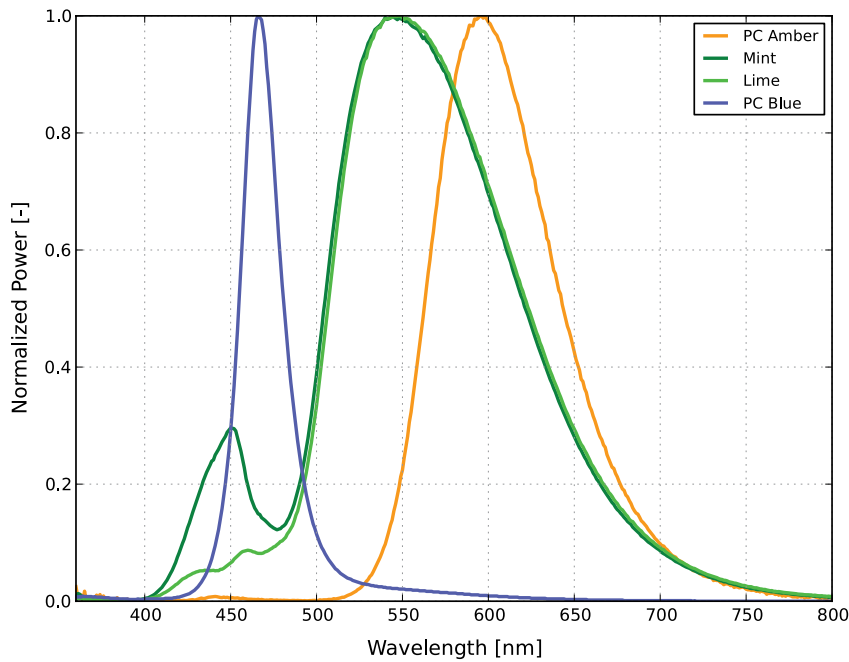

Figure 1b. Typical normalized power vs. wavelength for LUXEON C Phosphor Converted Colors at 350mA, $T_j=85^{\circ}\text{C}$.

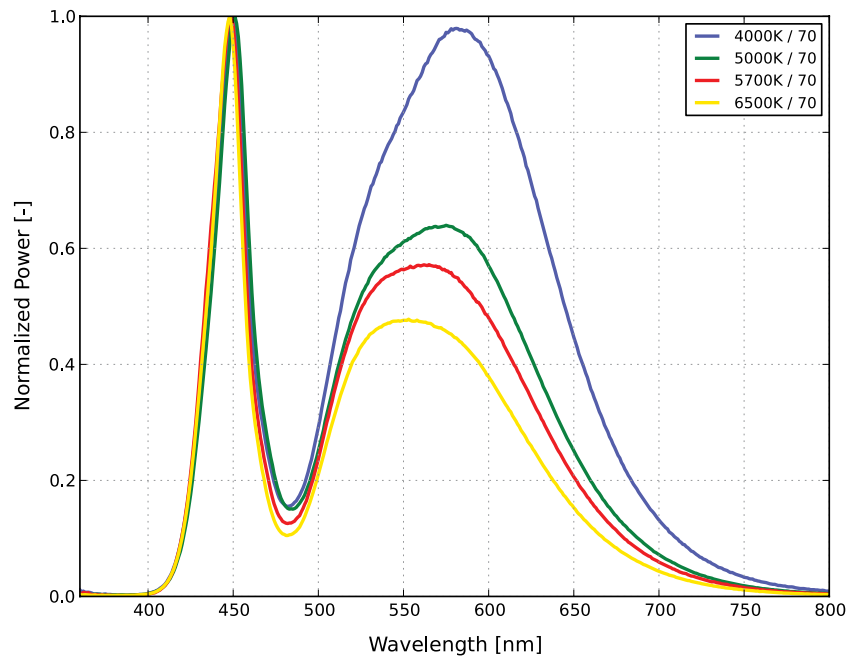

Figure 1c. Typical normalized power vs. wavelength for LUXEON C White 70CRI at 350mA, $T_j=85^\circ\text{C}$.

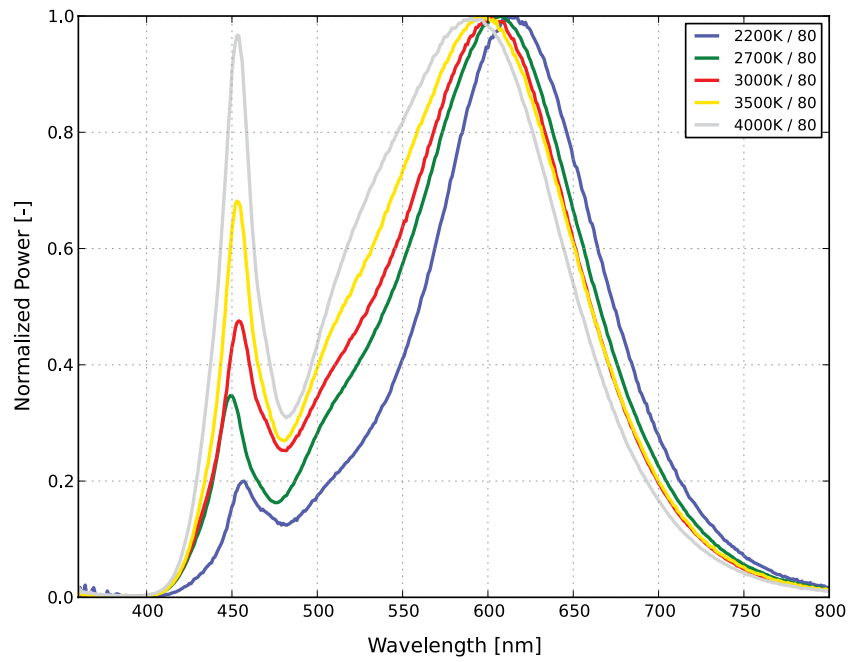

Figure 1d. Typical normalized power vs. wavelength for LUXEON C White 80CRI at 350mA, $T_j=85^\circ\text{C}$.

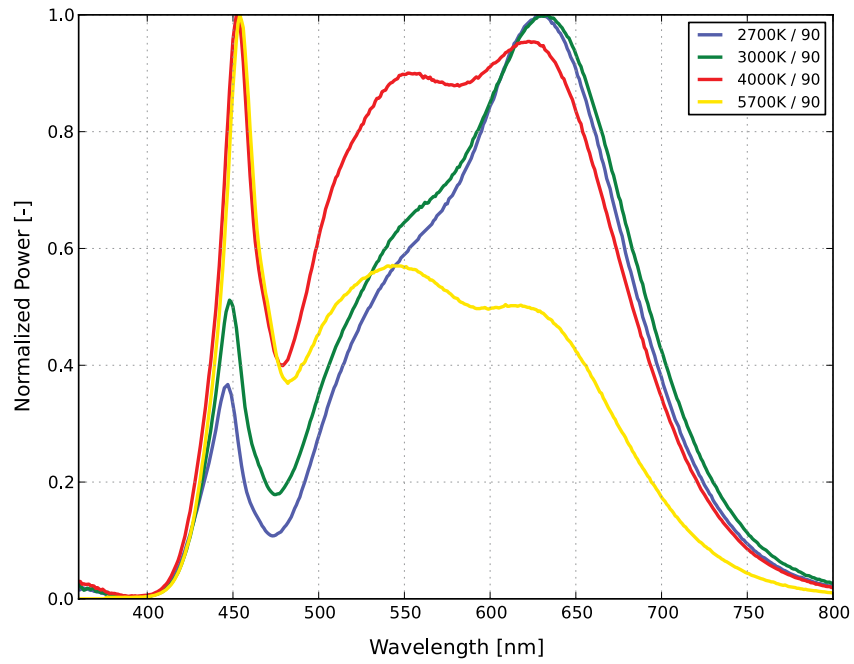

Figure 1e. Typical normalized power vs. wavelength for LUXEON C White 90CRI at 350mA, $T_j=85^\circ\text{C}$.

Light Output Characteristics

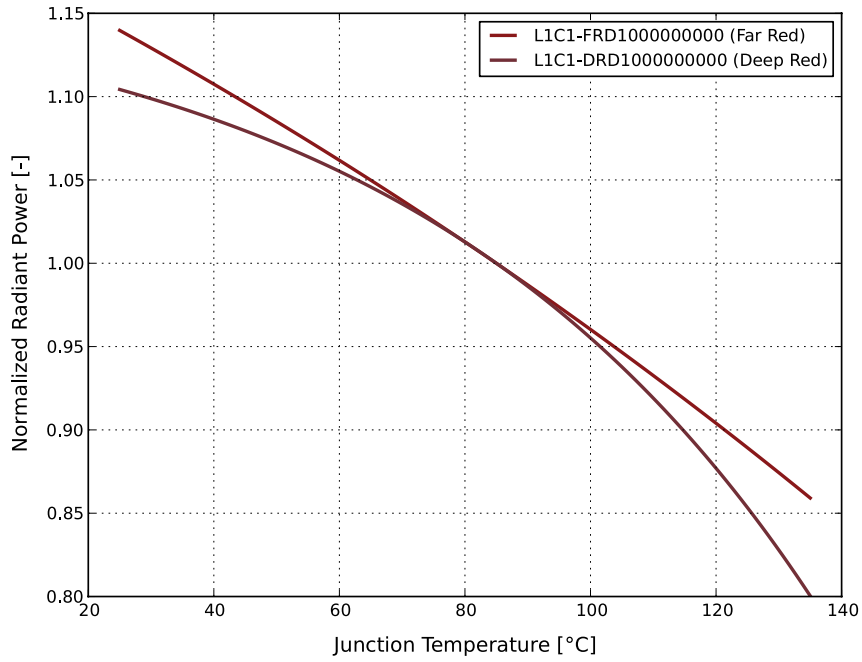

Figure 2a. Typical normalized radiant power vs. junction temperature for LUXEON C Far Red and Deep Red at 350mA.

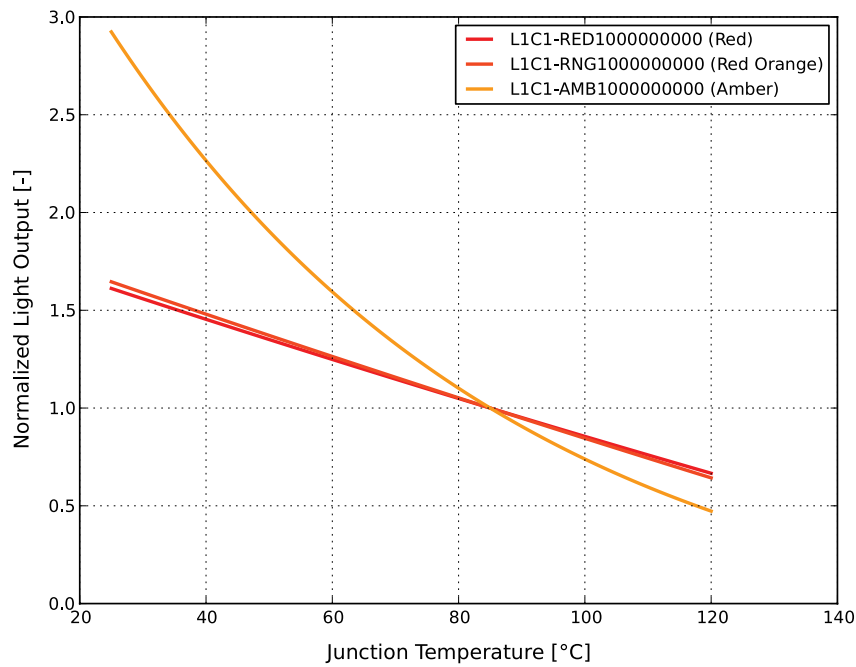

Figure 2b. Typical normalized light output vs. junction temperature for LUXEON C Red, Red-Orange and Amber at 350mA.

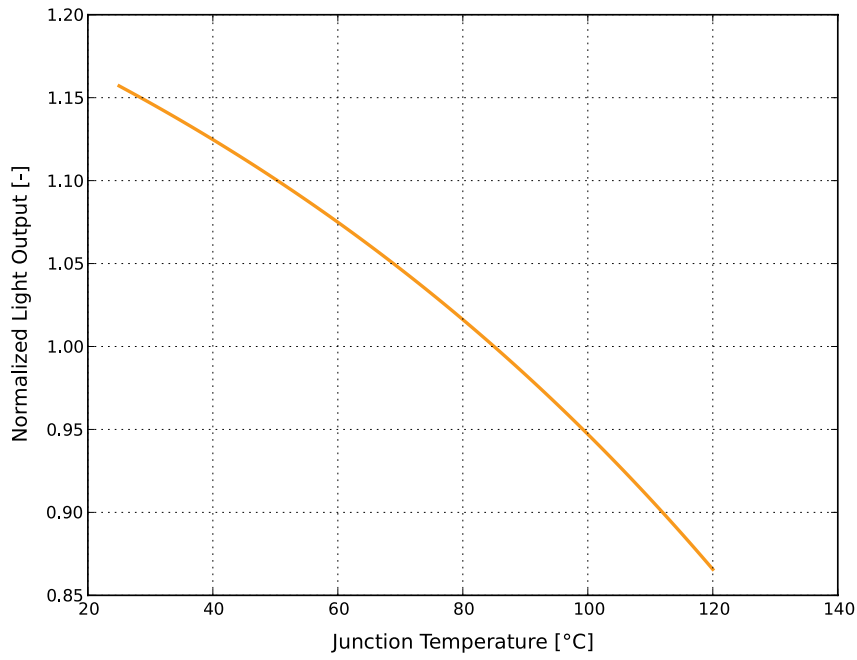

Figure 2c. Typical normalized light output vs. junction temperature for LUXEON C PC Amber at 350mA.

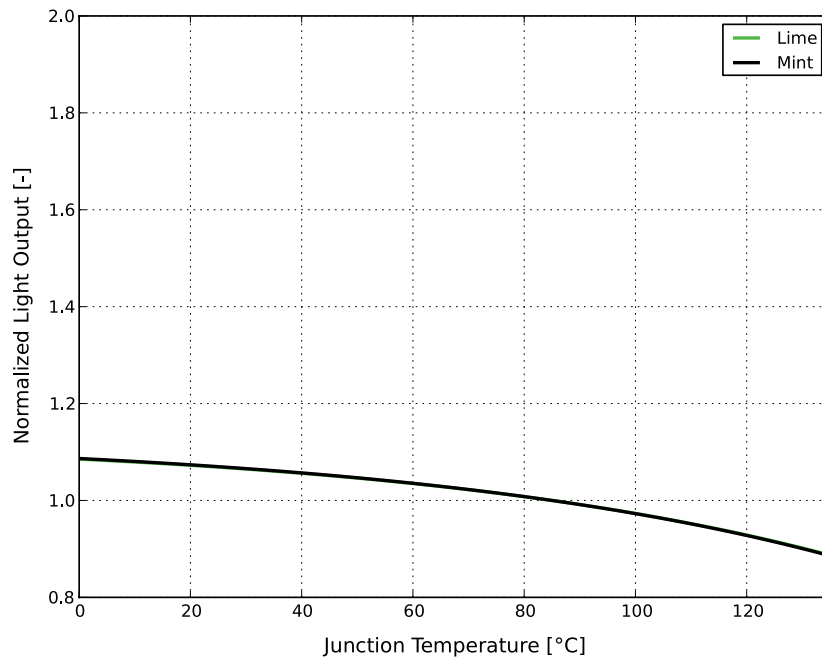

Figure 2d. Typical normalized light output vs. junction temperature for LUXEON C Mint and Lime at 350mA.

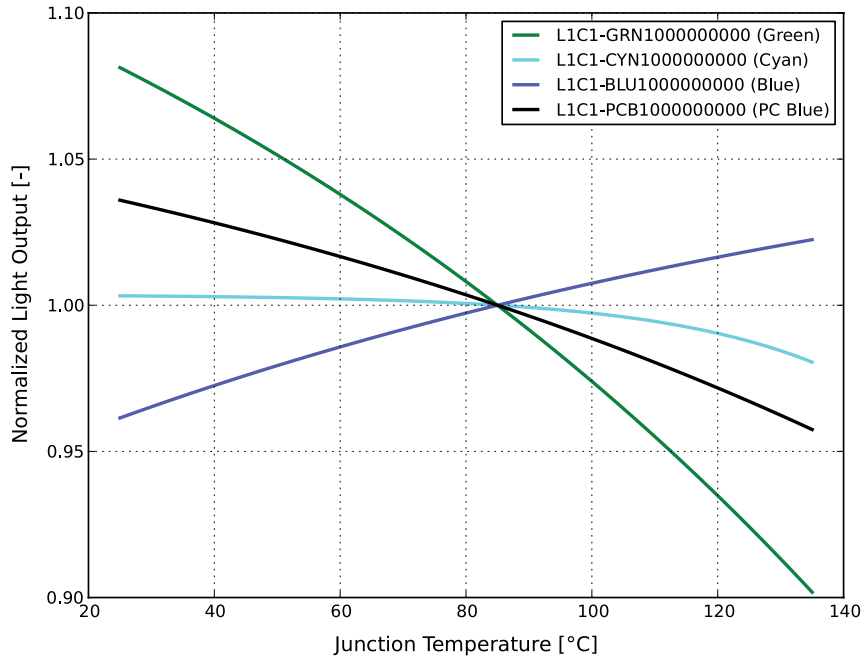

Figure 2e. Typical normalized light output vs. junction temperature for LUXEON C Green, Cyan, Blue and PC Blue at 350mA.

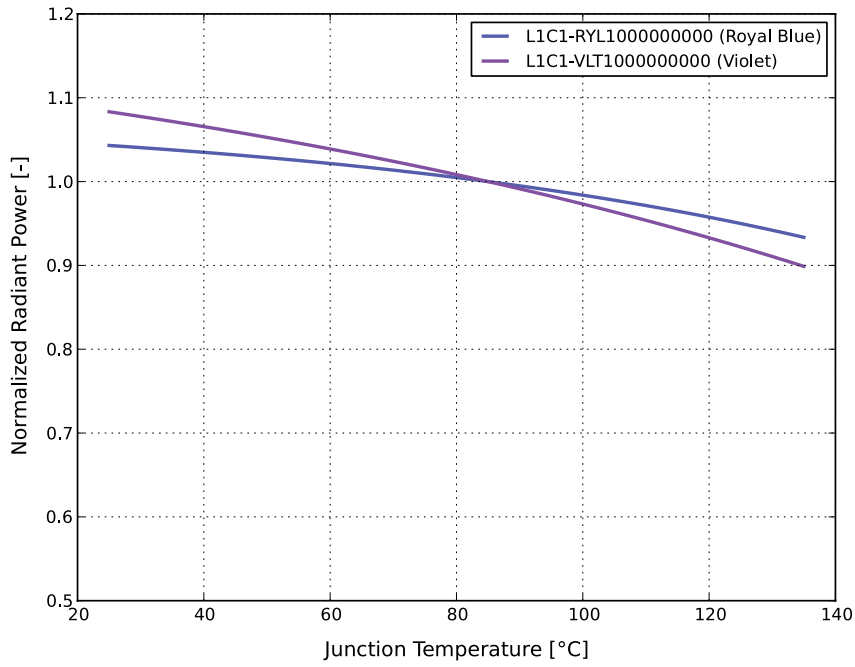

Figure 2f. Typical normalized radiant power vs. junction temperature for LUXEON C Royal Blue and Violet at 350mA.

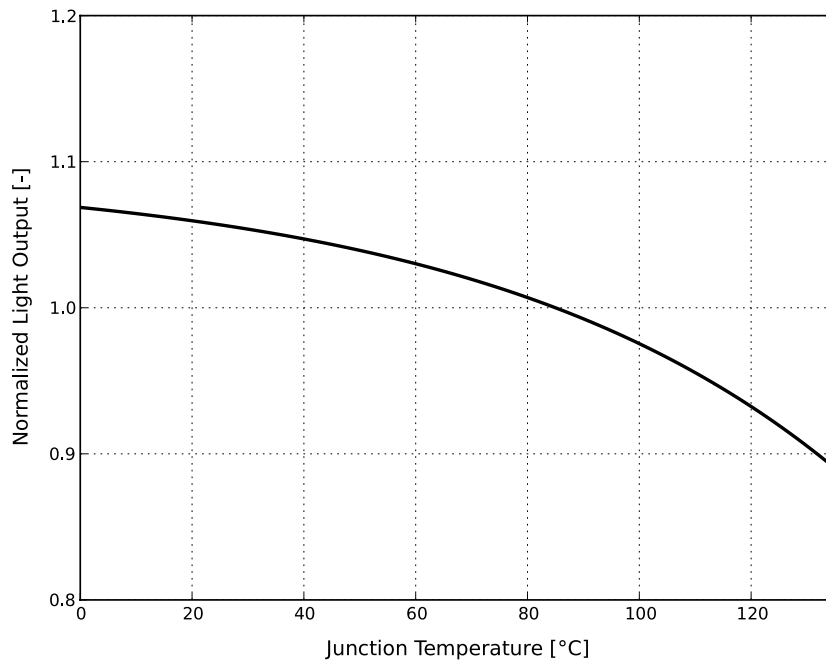

Figure 2g. Typical normalized light output vs. junction temperature for LUXEON C White at 350mA.

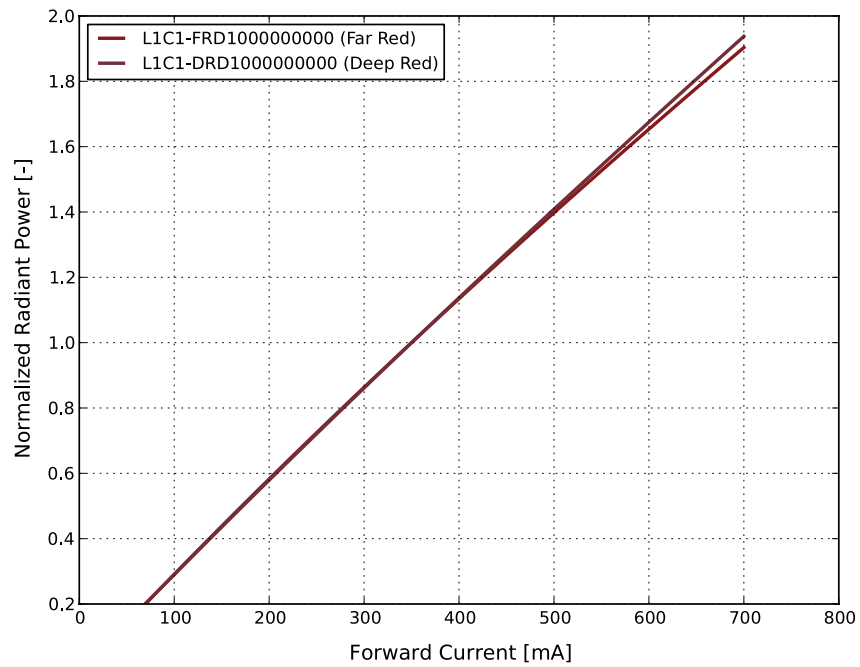

Figure 3a. Typical normalized radiant power vs. forward current for LUXEON C Far Red and Deep Red at $T_j=85^\circ\text{C}$.

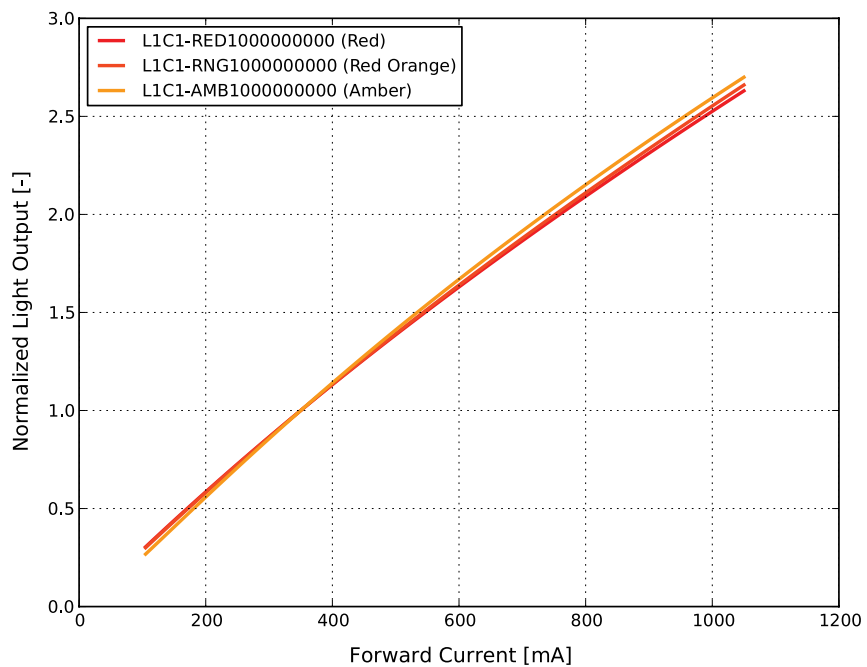

Figure 3b. Typical normalized light output vs. forward current for LUXEON C Red, Red-Orange and Amber at $T_j=85^\circ\text{C}$.

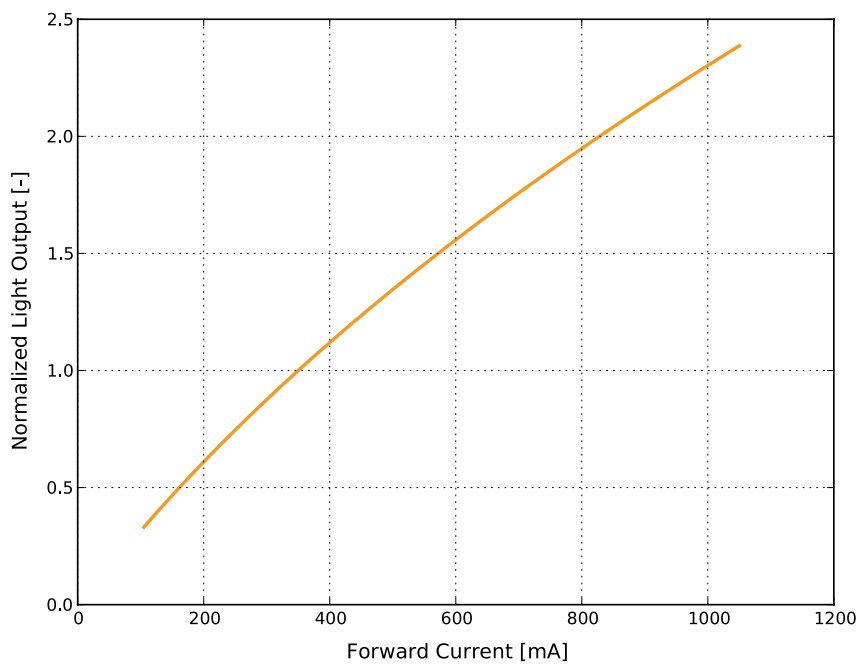

Figure 3c. Typical normalized light output vs. forward current for LUXEON C PC Amber at $T_j=85^\circ\text{C}$.

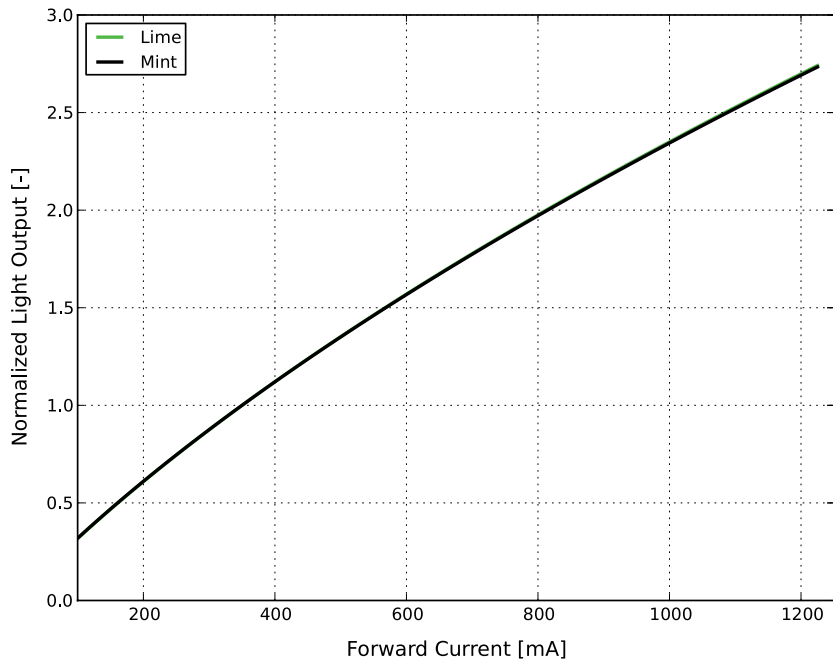

Figure 3d. Typical normalized light output vs. forward current for LUXEON C Mint and Lime at T_j=85°C.

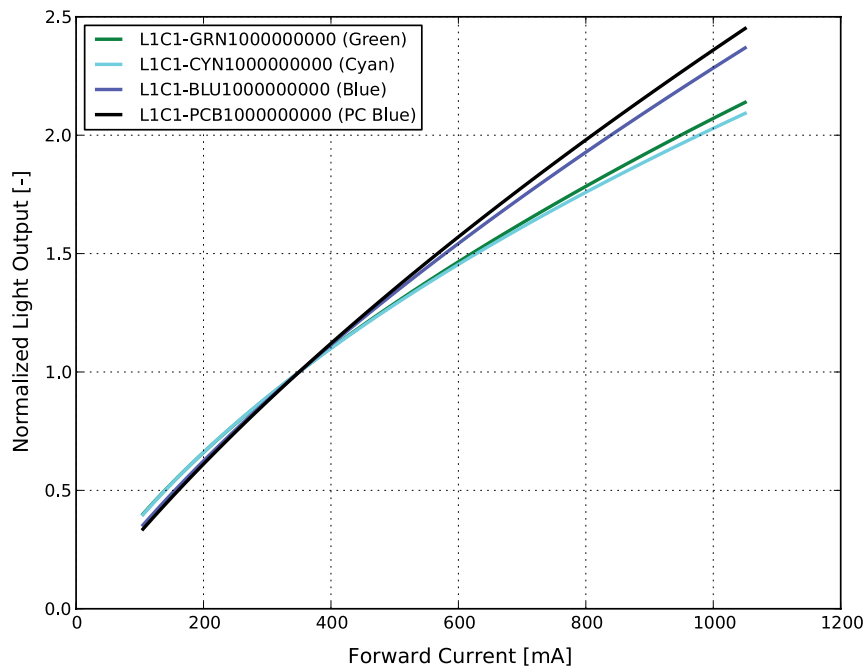

Figure 3e. Typical normalized light output vs. forward current for LUXEON C Green, Cyan, Blue and PC Blue at T_j=85°C.

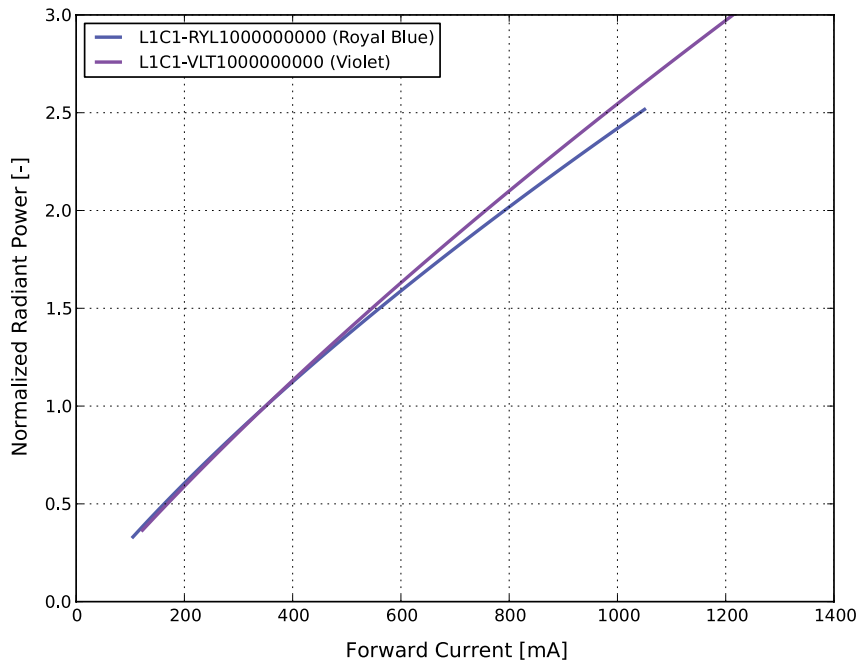

Figure 3f. Typical normalized radiant power vs. forward current for LUXEON C Royal Blue and Violet at $T_j=85^\circ\text{C}$.

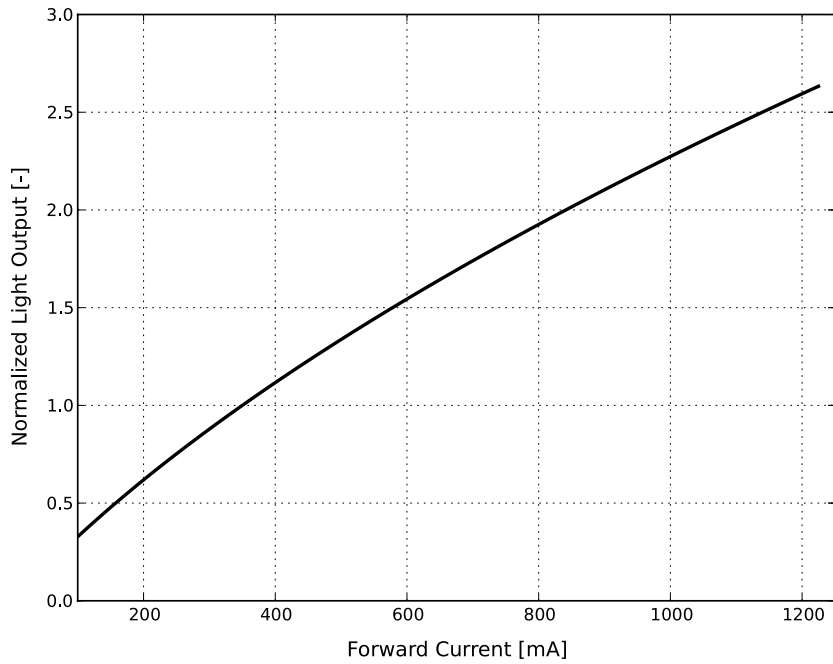

Figure 3g. Typical normalized light output vs. forward current for LUXEON C White at $T_j=85^\circ\text{C}$.

Forward Current Characteristics

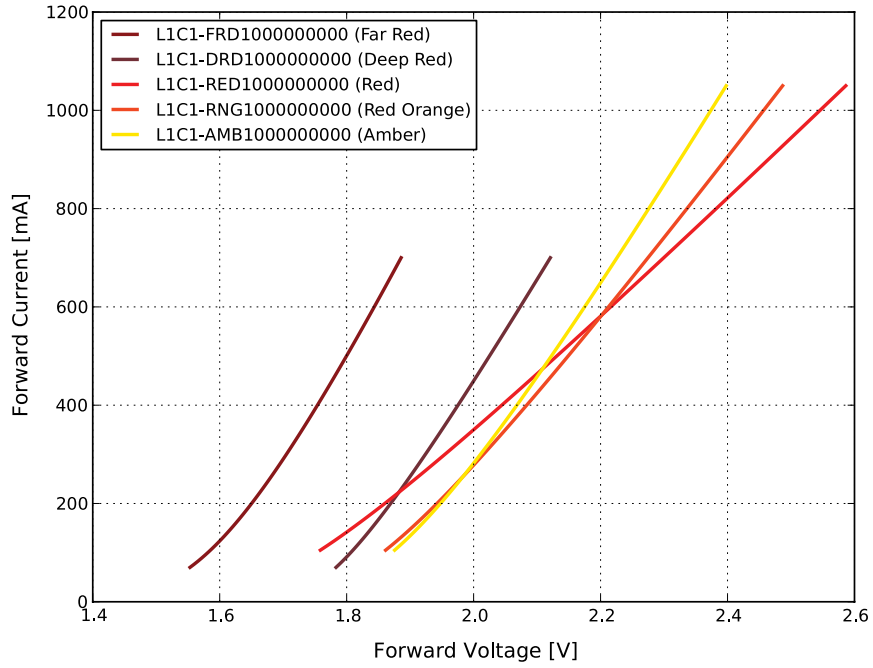

Figure 4a. Typical forward current vs. forward voltage for LUXEON C Far Red, Deep Red, Red, Red-Orange and Amber at $T_j=85^\circ\text{C}$.

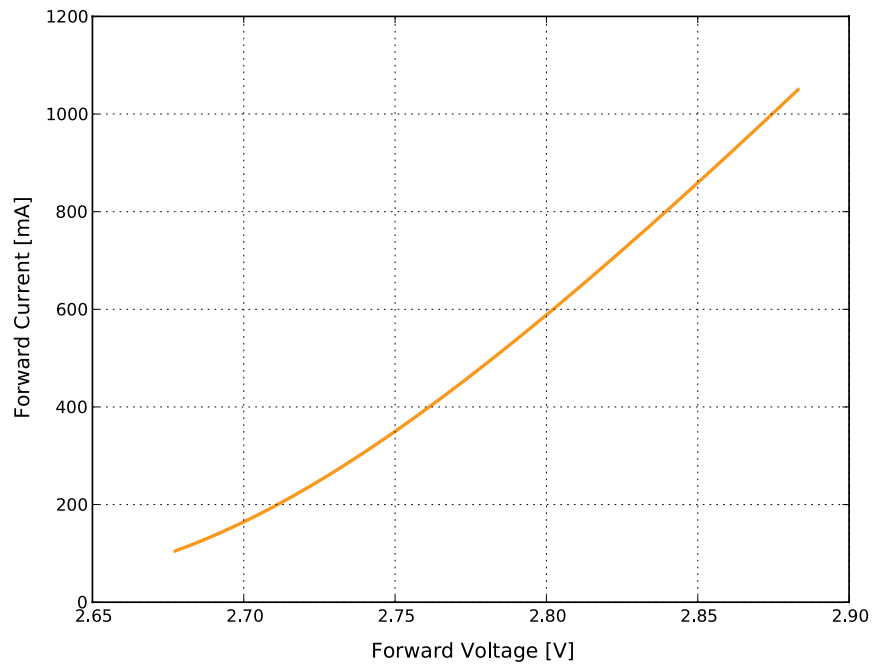

Figure 4b. Typical forward current vs. forward voltage for LUXEON C PC Amber at $T_j=85^\circ\text{C}$.

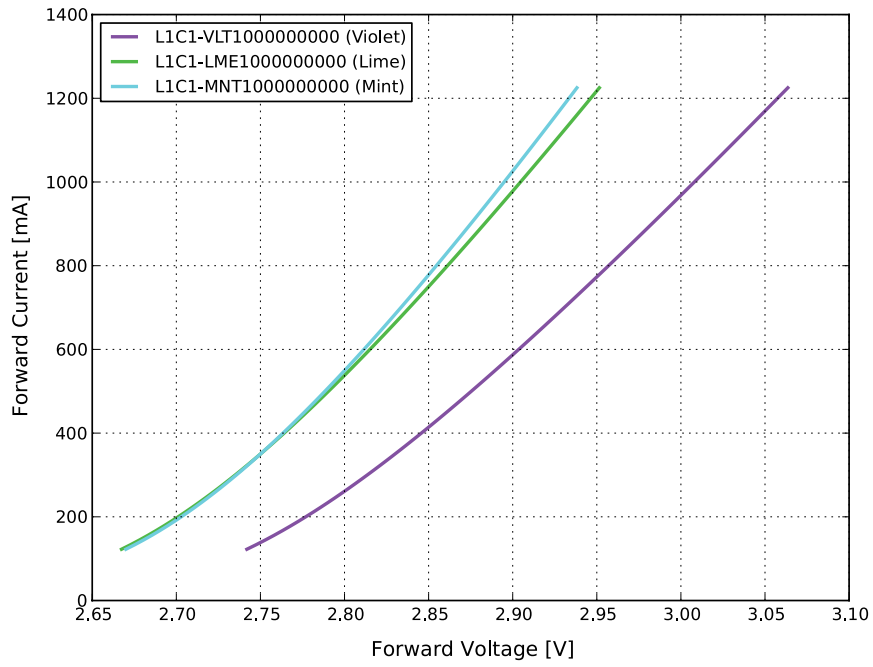

Figure 4c. Typical forward current vs. forward voltage for LUXEON C Mint, Lime and Violet at $T_j=85^\circ\text{C}$.

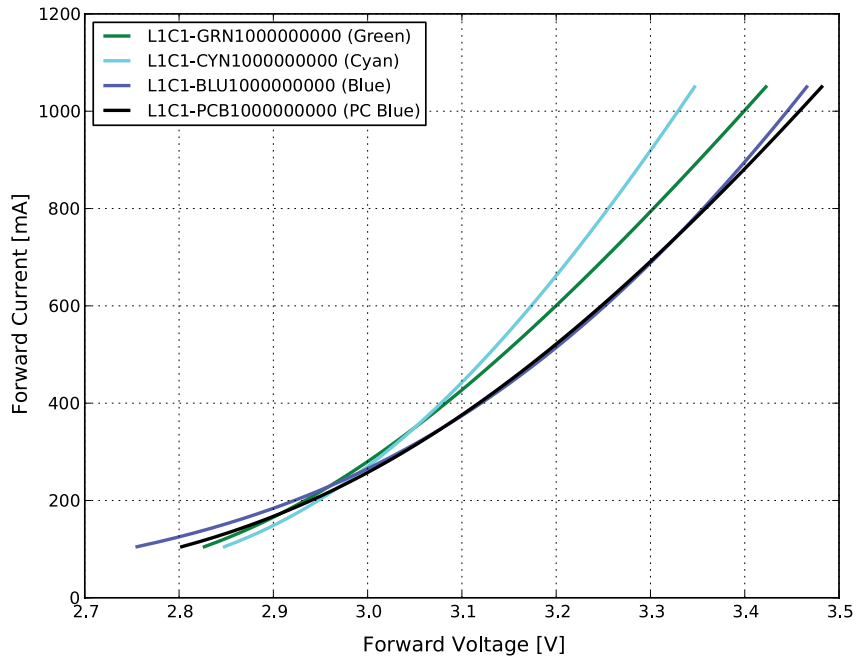

Figure 4d. Typical forward current vs. forward voltage for LUXEON C Green, Cyan, Blue and PC Blue at $T_j=85^\circ\text{C}$.

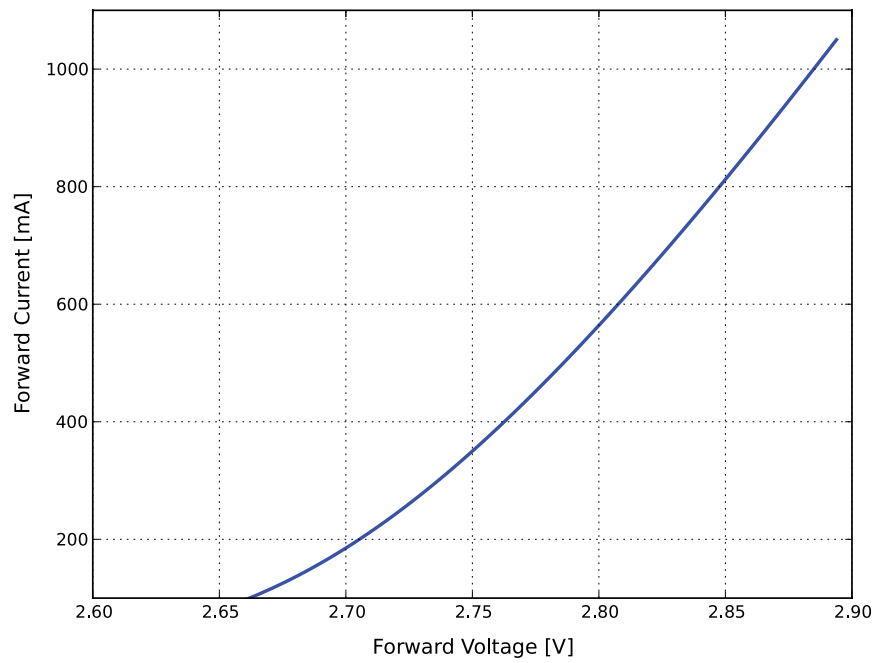

Figure 4e. Typical forward current vs. forward voltage for LUXEON C Royal Blue at $T_j=85^\circ\text{C}$.

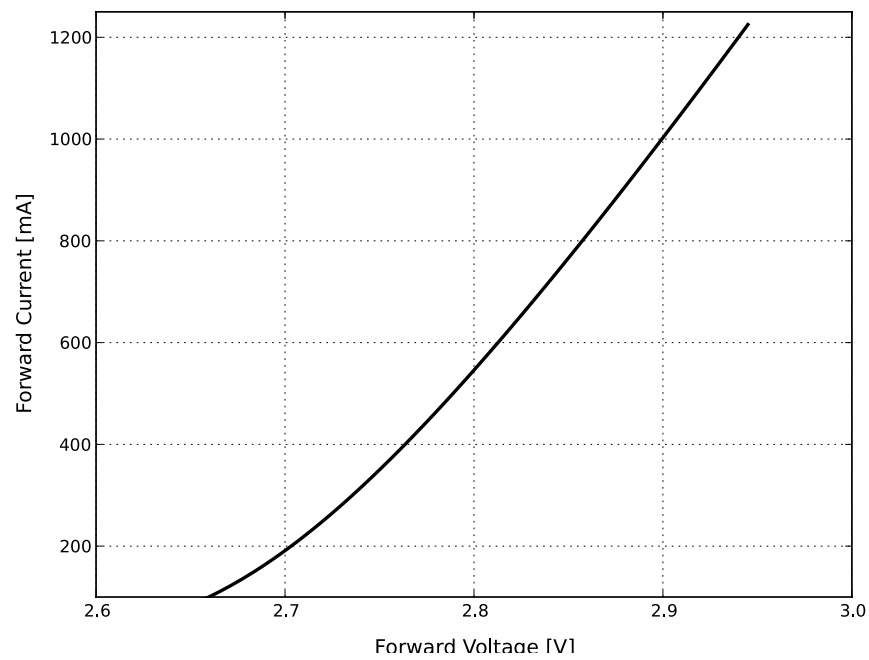

Figure 4f. Typical forward current vs. forward voltage for LUXEON C White at $T_j=85^\circ\text{C}$.

Radiation Pattern Characteristics

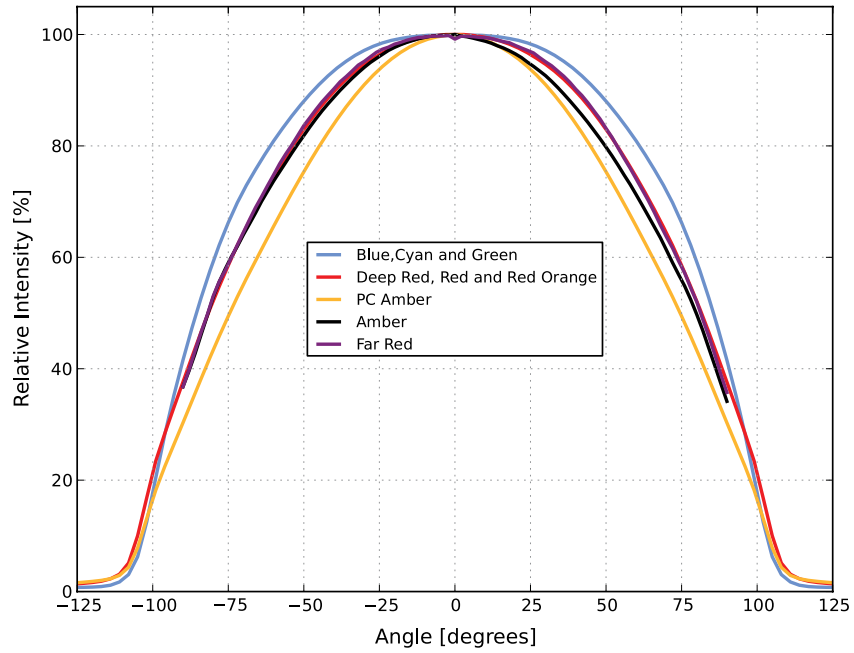

Figure 5a. Typical radiation pattern for LUXEON C Far Red, Deep Red, Red, Red-Orange, Amber, PC Amber, Green, Cyan and Blue at 350mA, $T_j=85^\circ\text{C}$.

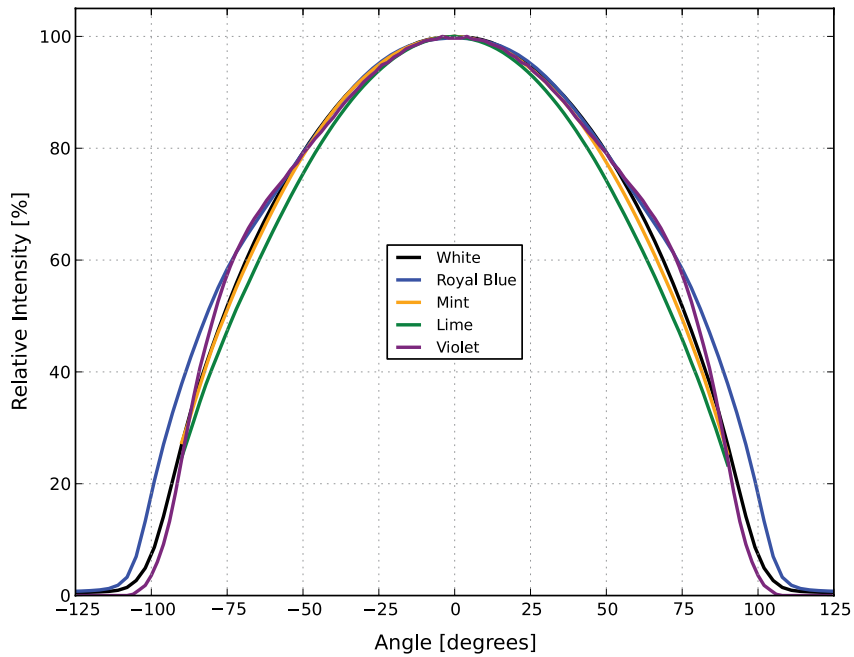

Figure 5b. Typical radiation pattern for LUXEON C Mint, Lime, Royal Blue, White and Violet at 350mA, $T_j=85^\circ\text{C}$.

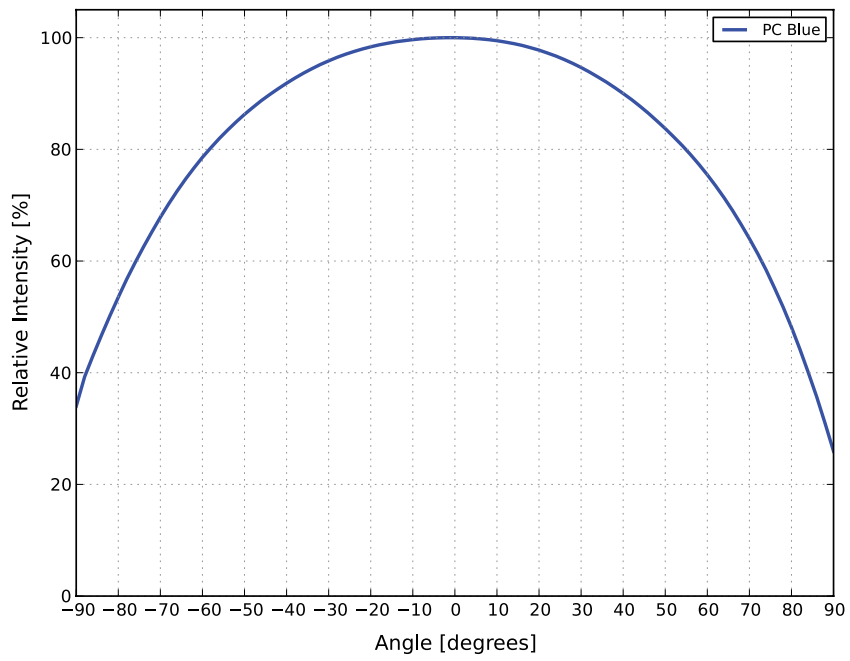

Figure 5c. Typical radiation pattern for LUXEON C PC Blue at 350mA, $T_j=85^\circ\text{C}$.

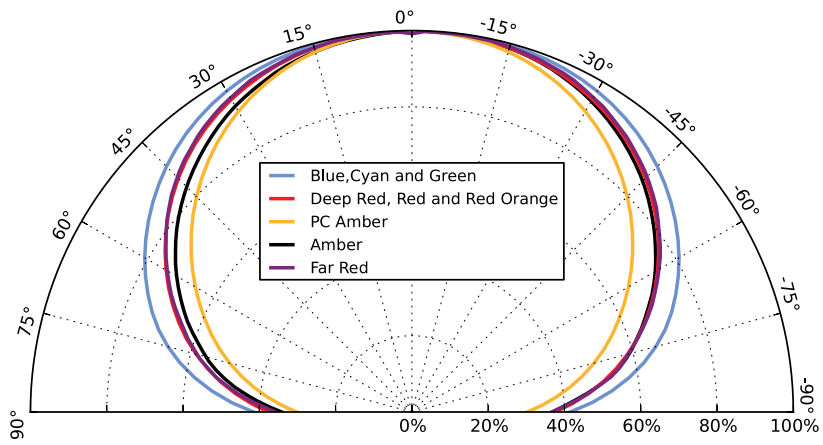

Figure 6a. Typical polar radiation pattern for LUXEON C Far Red, Deep Red, Red, Red-Orange, Amber, PC Amber, Green, Cyan and Blue at 350mA, $T_j=85^\circ\text{C}$.

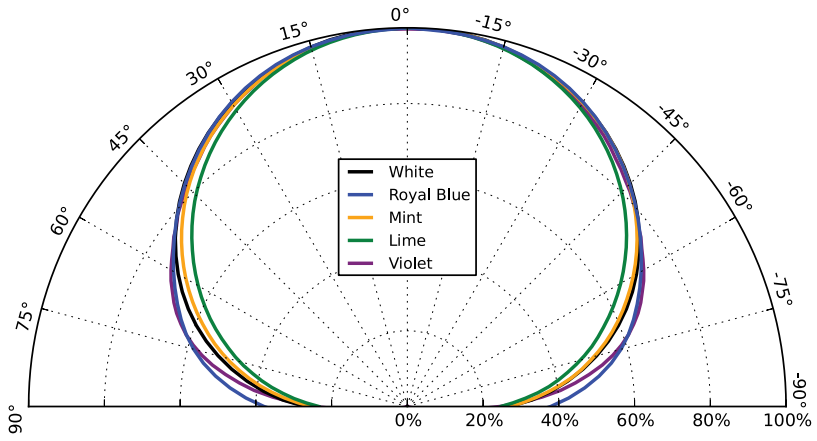

Figure 6b. Typical polar radiation pattern for LUXEON C Mint, Lime, Royal Blue, White and Violet at 350mA, $T_j=85^\circ\text{C}$.

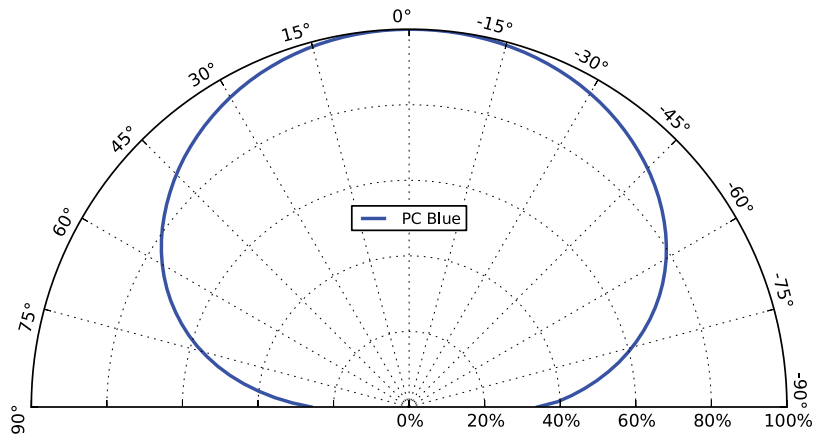

Figure 6c. Typical polar radiation pattern for LUXEON C PC Blue at 350mA, $T_j=85^\circ\text{C}$.

Product Bin and Labeling Definitions

Decoding Product Bin Labeling

In the manufacturing of semiconductor products, there are variations in performance around the average values given in the technical datasheet. For this reason, Lumileds bins LED components for luminous flux, radiometric power, color point, peak wavelength, dominant wavelength and forward voltage.

LUXEON C Color Line LEDs are labeled using a 4-digit alphanumeric CAT code following the format below:

A B C D

Where:

- A** – designates luminous flux bin or radiometric power bin (luminous flux bin example: A=20 to 25 lm, B=25 to 30 lm; radiometric power bin example: Far Red C=280 to 320mW, Royal Blue J=520 to 560mW)
- B C** – designates color bin, peak wavelength bin or dominant wavelength bin (peak wavelength bin example: Deep Red 10=655 to 665nm; dominant wavelength bin example: Red 40=624 to 634nm)
- D** – designates forward voltage bin (example: A=1.70 to 1.90V, B=1.90 to 2.10V)

Therefore, a LUXEON C Red LED with a lumen range of 20 to 25 lm, a dominant wavelength of 624 to 634nm and a forward voltage range of 1.70 to 1.90V has the following CAT code:

A 4 0 A

Luminous Flux Bins

Table 5 lists the standard photometric luminous flux bins for LUXEON C Color Line emitters. Although several bins are outlined, product availability in a particular bin varies by production run and by product performance. Not all bins are available in all CCTs.

Table 5. Luminous flux bin definitions for LUXEON C Color Line.

BIN	LUMINOUS FLUX ^[1] (lm)	
	MINIMUM	MAXIMUM
A	20	25
B	25	30
C	30	35
D	35	40
E	40	45
F	45	50
G	50	55
H	55	60
J	60	65
K	65	70
L	70	75
M	75	80
N	80	90
P	90	100
Q	100	110
R	110	120
S	120	130
T	130	140
U	140	150
V	150	170
W	170	190

Notes for Table 5:

1. Lumileds maintains a tolerance of $\pm 6.5\%$ on luminous flux measurements.

Radiometric Power Bins

Table 6. Radiometric power bin definitions for LUXEON C Far Red, Deep Red and Royal Blue and Violet.

COLOR	PART NUMBER	BIN	RADIOMETRIC POWER ^[1] (mW)	
			MINIMUM	MAXIMUM
Far Red	L1C1-FRD1000000000	A	190	240
		B	240	280
		C	280	320
		D	320	360
		E	360	400
Deep Red	L1C1-DRD1000000000	C	280	320
		D	320	360
		E	360	400
		F	400	440
		G	440	480
Royal Blue	L1C1-RYL1000000000	H	480	520
		J	520	560
		K	560	600
		L	600	640
Violet	L1C1-VTL1000000000	H	480	520
		J	520	560
		K	560	600
		L	600	640

Notes for Table 6:

1. Lumileds maintains a tolerance of ±6.5% on radiometric power measurements.

Color Bin Definitions

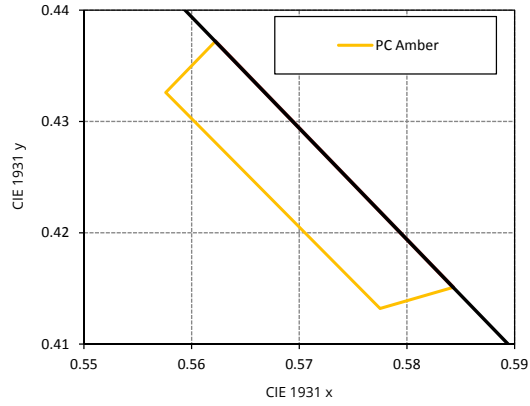

Figure 7. Color bin structure for LUXEON C PC Amber for Table 7.

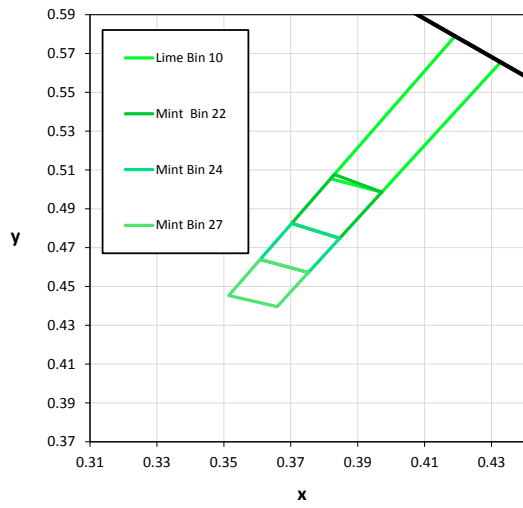

Figure 8. Color bin structure for LUXEON C Mint and Lime for Table 7.

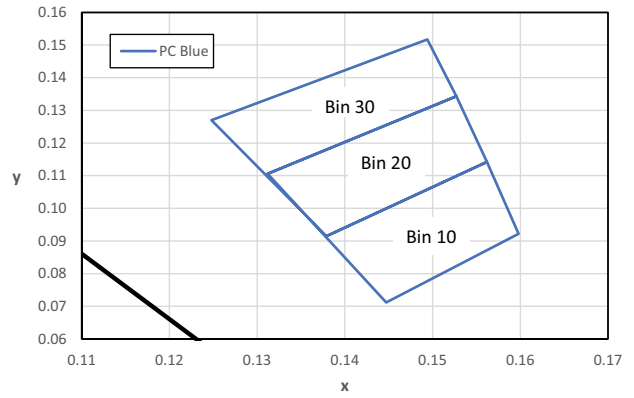

Figure 9. Color bin structure for LUXEON C PC Blue for Table 7.

Table 7. Color bin definitions for LUXEON C PC Amber, Mint, Lime and PC Blue.

COLOR	PART NUMBER	BIN	x	y
PC Amber	L1C1-PCA1000000000	20	0.5622	0.4372
			0.5576	0.4326
			0.5775	0.4132
			0.5843	0.4151
Mint	L1C1-MNT1000000000	22	0.3972	0.4986
			0.3830	0.5077
			0.3703	0.4825
			0.3846	0.4749
		24	0.3846	0.4749
			0.3703	0.4825
			0.3608	0.4639
			0.3752	0.4572
		27	0.3752	0.4572
			0.3608	0.4639
			0.3515	0.4453
			0.3659	0.4396
Lime	L1C1-LME1000000000	10	0.3819	0.5055
			0.4191	0.5790
			0.4327	0.5655
			0.3972	0.4986
PC Blue	L1C1-PCB1000000000	10	0.1379	0.0915
			0.1562	0.1142
			0.1598	0.0922
			0.1447	0.0712
		20	0.1312	0.1106
			0.1527	0.1343
			0.1562	0.1142
			0.1379	0.0915
		30	0.1248	0.1270
			0.1494	0.1517
			0.1527	0.1343
			0.1312	0.1106

Notes for Table 7:

1. Lumileds maintains a tolerance of ± 0.005 on x and y color coordinates measurements.

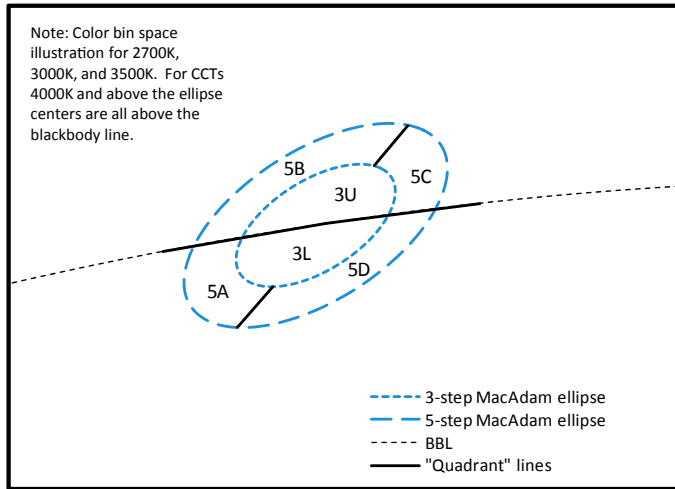

Figure 10. Color bin structure for LUXEON C Color Line.

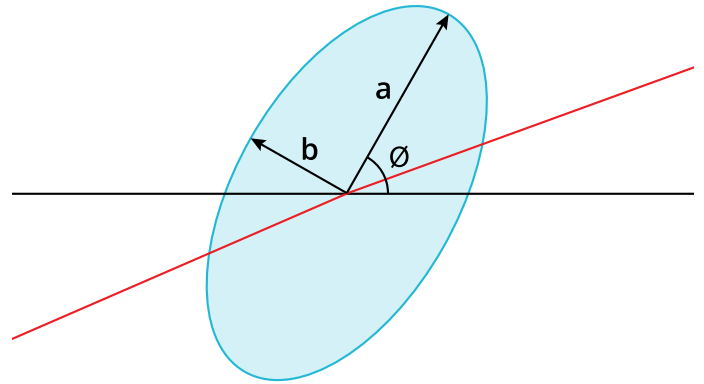

Figure 11. 3- and 5-step MacAdam ellipse illustration for Table 7.

Table 8a. 3- and 5-step MacAdam ellipse color bin definitions for LUXEON C White at 350mA, $T_j = 85^\circ\text{C}$.

NOMINAL CCT	COLOR SPACE	CENTER POINT ⁽¹⁾ (cx, cy)	MAJOR AXIS, a	MINOR AXIS, b	ELLIPSE ROTATION ANGLE, θ
2200K	Single 3-step MacAdam ellipse	(0.5020, 0.4156)	0.00863	0.00398	49.3°
2700K	Single 3-step MacAdam ellipse	(0.4578, 0.4101)	0.00810	0.00420	53.7°
3000K	Single 3-step MacAdam ellipse	(0.4338, 0.4030)	0.00834	0.00408	53.2°
3500K	Single 3-step MacAdam ellipse	(0.4073, 0.3917)	0.00927	0.00414	54.0°
4000K	Single 3-step MacAdam ellipse	(0.3818, 0.3797)	0.00939	0.00402	53.7°
2200K	Single 5-step MacAdam ellipse	(0.5020, 0.4156)	0.01438	0.00663	49.3°
2700K	Single 5-step MacAdam ellipse	(0.4578, 0.4101)	0.01350	0.00700	53.7°
3000K	Single 5-step MacAdam ellipse	(0.4338, 0.4030)	0.01390	0.00680	53.2°
3500K	Single 5-step MacAdam ellipse	(0.4073, 0.3917)	0.01545	0.00690	54.0°
4000K	Single 5-step MacAdam ellipse	(0.3818, 0.3797)	0.01565	0.00670	53.7°
5000K	Single 5-step MacAdam ellipse	(0.3447, 0.3553)	0.01370	0.00590	59.6°
5700K	Single 5-step MacAdam ellipse	(0.3287, 0.3417)	0.01243	0.00533	59.1°
6500K	Single 5-step MacAdam ellipse	(0.3123, 0.3282)	0.01115	0.00475	58.6°

Notes for Table 8a:

1. Lumileds maintains a tolerance of ± 0.005 on x and y coordinates in the CIE 1931 color space.

Table 8b. MacAdam ellipse color bin definitions for LUXEON C Colors.

BIN	SDCM
30	Single 3-step MacAdam ellipse (90CRI for CCTs 4000K and above)
3U	Single 3-step MacAdam ellipse (80CRI for all CCTs and 90CRI only for CCTs below 4000K)
3L	Single 3-step MacAdam ellipse (80CRI for all CCTs and 90CRI only for CCTs below 4000K)
50	Single 5-step MacAdam ellipse (70CRI)
5A	Single 5-step MacAdam ellipse (80CRI and 90CRI)
5B	Single 5-step MacAdam ellipse (80CRI and 90CRI)
5C	Single 5-step MacAdam ellipse (80CRI and 90CRI)
5D	Single 5-step MacAdam ellipse (80CRI and 90CRI)

Peak Wavelength Bins

Table 9. Peak wavelength bin definitions for LUXEON C Far Red, Deep Red, Royal Blue and Violet.

COLOR	PART NUMBER	BIN	PEAK WAVELENGTH ^[1] (nm)	
			MINIMUM	MAXIMUM
Far Red	L1C1-FRD1000000000	10	720	730
		20	730	740
		30	740	750
Deep Red	L1C1-DRD1000000000	10	655	665
		20	665	675
		30	440	445
Royal Blue	L1C1-RYL1000000000	40	445	450
		50	450	455
		60	455	460
		10	420	430
Violet	L1C1-VLT1000000000	10	420	430

Notes for Table 9:

1. Lumileds maintains a tolerance of ± 2.0 nm on peak wavelength measurements.

Dominant Wavelength Bins

Table 10. Dominant wavelength bin definitions for LUXEON C Red, Red-Orange, Amber, Green, Cyan and Blue at 350mA, $T_j=85^\circ\text{C}$.

COLOR	PART NUMBER	BIN	DOMINANT WAVELENGTH ^[1] (nm)	
			MINIMUM	MAXIMUM
Red	L1C1-RED1000000000	40	624.0	634.0
Red-Orange	L1C1-RNG1000000000	20	614.0	624.0
Amber	L1C1-AMB1000000000	10	585.0	590.0
		20	590.0	594.5
		30	594.5	600.0
Green	L1C1-GRN1000000000	10	520.0	525.0
		20	525.0	530.0
		30	530.0	535.0
		40	535.0	540.0
Cyan	L1C1-CYN1000000000	10	490.0	496.0
		20	496.0	500.0
		30	500.0	505.0
		40	505.0	510.0
Blue	L1C1-BLU1000000000	10	460.0	465.0
		20	465.0	470.0
		30	470.0	475.0
		40	475.0	480.0
		50	480.0	485.0

Notes for Table 10:

1. Lumileds maintains a tolerance of ± 0.5 nm on dominant wavelength measurements.

Forward Voltage Bins

Table 11. Forward voltage bin definitions for LUXEON C Color Line.

BIN	FORWARD VOLTAGE ⁽¹⁾ (V _f)	
	MINIMUM	MAXIMUM
Z	1.50	1.70
A	1.70	1.90
B	1.90	2.10
C	2.10	2.30
D	2.30	2.50
E	2.50	2.70
F	2.70	2.90
G	2.90	3.10
H	3.10	3.30
J	3.30	3.50

Notes for Table 11:

1. Lumileds maintains a tolerance of $\pm 0.06V$ on forward voltage measurements.

Mechanical Dimensions

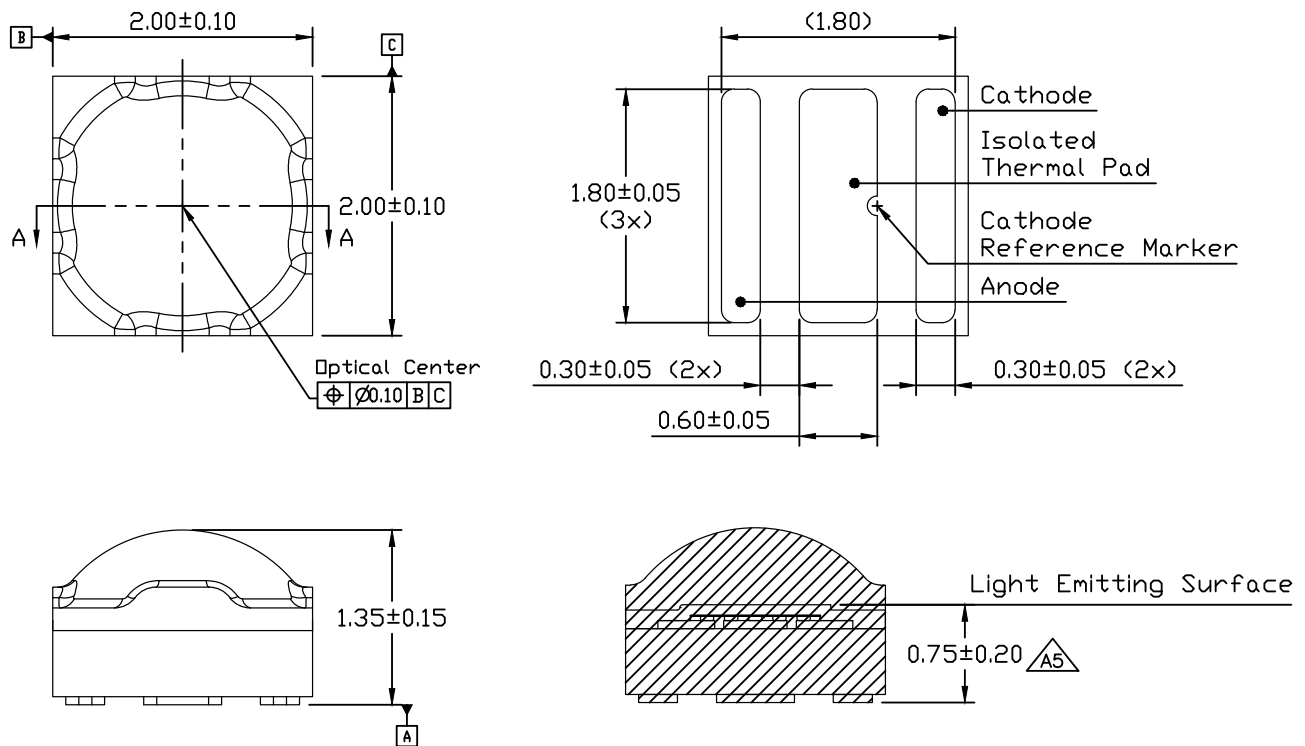

Figure 12. Mechanical dimensions for LUXEON C Color Line.

Notes for Figure 12:

1. Drawings are not to scale.
2. All dimensions are in millimeters.

Reflow Soldering Guidelines

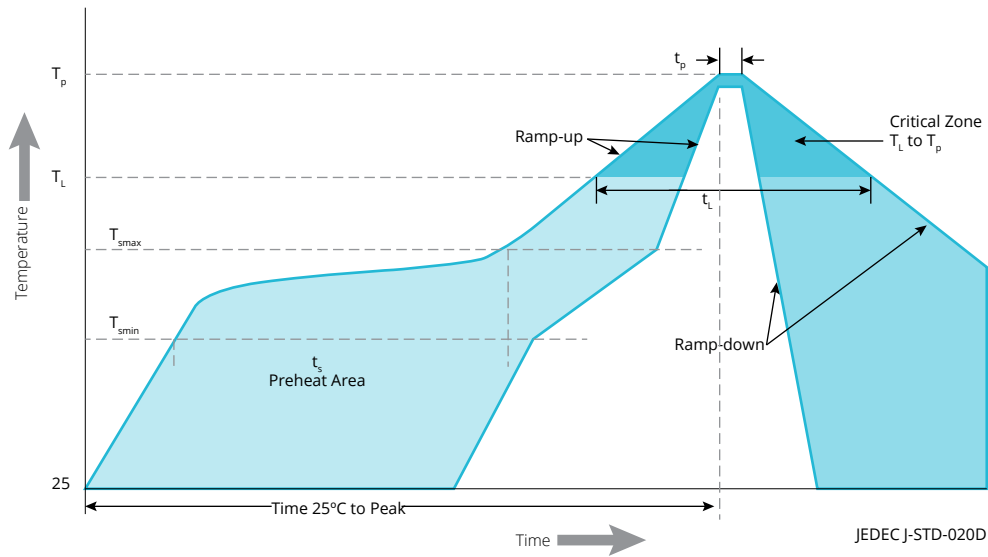

Figure 13. Visualization of the acceptable reflow temperature profile as specified in Table 12.

Table 12. Reflow profile characteristics for LUXEON C Color Line.

PROFILE FEATURE	LEAD-FREE ASSEMBLY
Preheat Minimum Temperature (T_{smin})	150°C
Preheat Maximum Temperature (T_{smax})	200°C
Preheat Time (t_{smin} to t_{smax})	60 to 120 seconds
Ramp-Up Rate (T_L to T_p)	3°C / second maximum
Liquidus Temperature (T_L)	217°C
Time Maintained Above Temperature T_L (t_L)	60 to 150 seconds
Peak / Classification Temperature (T_p)	260°C
Time Within 5°C of Actual Temperature (t_p)	20 to 40 seconds
Ramp-Down Rate (T_p to T_L)	6°C / second maximum
Time 25°C to Peak Temperature	8 minutes maximum

JEDEC Moisture Sensitivity

Table 13. Moisture sensitivity levels for LUXEON C Color Line.

LEVEL	FLOOR LIFE		SOAK REQUIREMENTS STANDARD	
	TIME	CONDITIONS	TIME	CONDITIONS
1	Unlimited	≤30°C / 85% RH	168 Hours +5 / -0	85°C / 85% RH

Solder Pad Design

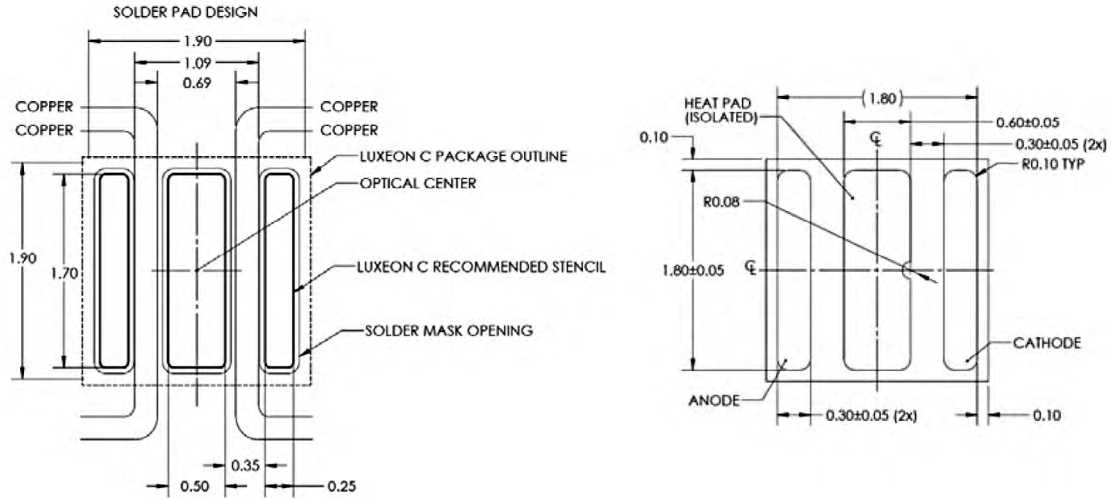

Figure 14. Recommended PCB solder pad layout for LUXEON C Color Line.

Notes for Figure 14:

1. Drawings are not to scale.
2. All dimensions are in millimeters.
3. The drawing above shows the recommended solder pad layout on Printed Circuit Board (PCB).

Packaging Information

Pocket Tape Dimensions

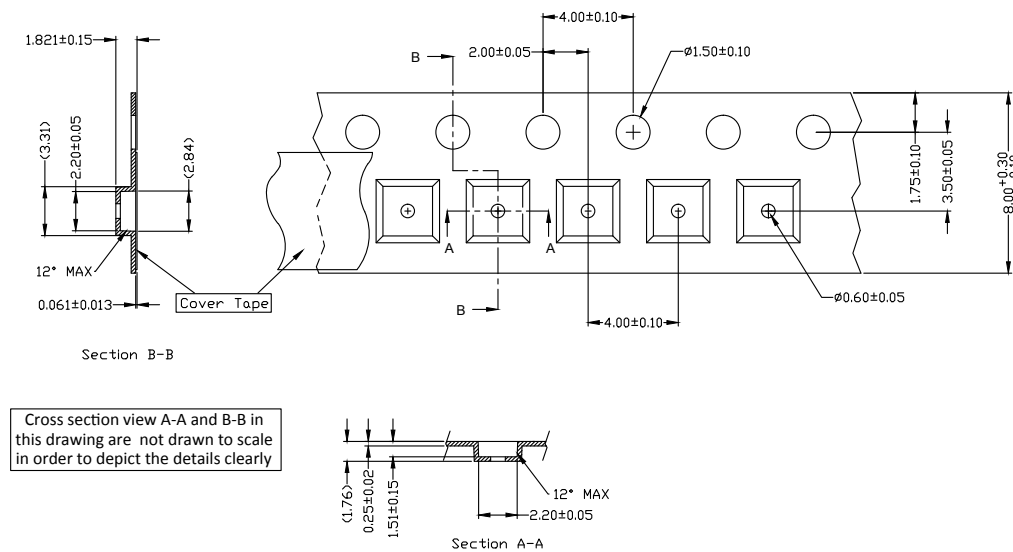

Figure 15. Pocket Tape dimensions for LUXEON C Color Line.

Notes for Figure 15:

1. Drawings are not to scale.
2. All dimensions are in millimeters.

Reel Dimensions

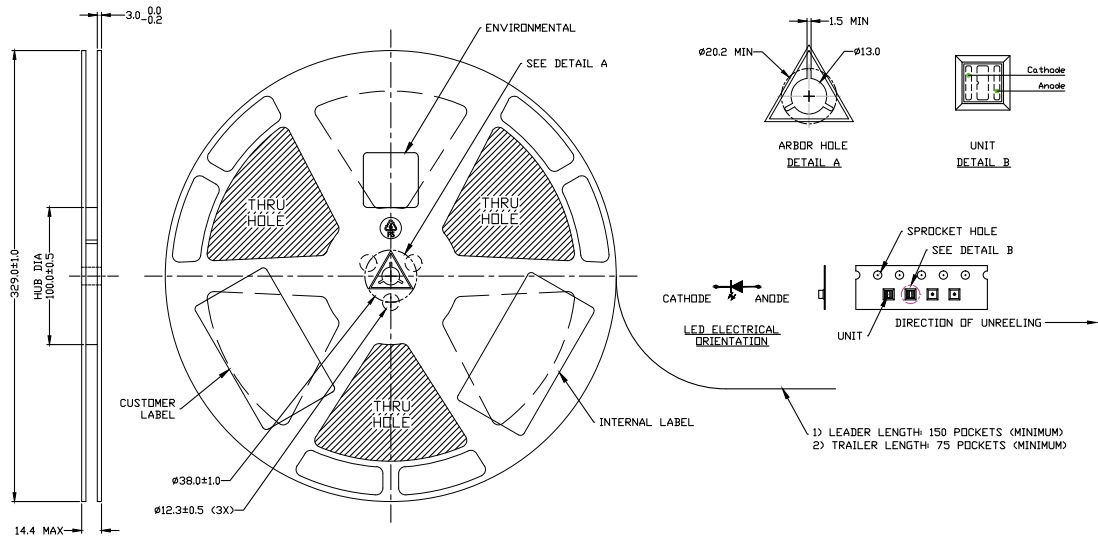

Figure 16. Reel dimensions for LUXEON C Color Line.

Notes for Figure 16:

1. Drawings are not to scale.
2. All dimensions are in millimeters.
3. Maximum 1,000 pieces per reel.

About Lumileds

Companies developing automotive, mobile, IoT and illumination lighting applications need a partner who can collaborate with them to push the boundaries of light. With over 100 years of inventions and industry firsts, Lumileds is a global lighting solutions company that helps customers around the world deliver differentiated solutions to gain and maintain a competitive edge. As the inventor of Xenon technology, a pioneer in halogen lighting and the leader in high performance LEDs, Lumileds builds innovation, quality and reliability into its technology, products and every customer engagement. Together with its customers, Lumileds is making the world better, safer, more beautiful—with light.

To learn more about our lighting solutions, visit lumileds.com.



©2022 Lumileds Holding B.V. All rights reserved.
LUXEON is a registered trademark of the Lumileds Holding B.V. in the United States and other countries.

lumileds.com

Neither Lumileds Holding B.V. nor its affiliates shall be liable for any kind of loss of data or any other damages, direct, indirect or consequential, resulting from the use of the provided information and data. Although Lumileds Holding B.V. and/or its affiliates have attempted to provide the most accurate information and data, the materials and services information and data are provided "as is," and neither Lumileds Holding B.V. nor its affiliates warrants or guarantees the contents and correctness of the provided information and data. Lumileds Holding B.V. and its affiliates reserve the right to make changes without notice. You as user agree to this disclaimer and user agreement with the download or use of the provided materials, information and data. A listing of Lumileds product/patent coverage may be accessed at lumileds.com/patents.

Mouser Electronics

Authorized Distributor

Click to View Pricing, Inventory, Delivery & Lifecycle Information:

Lumileds:

[L1C1-5770000000000](#) [L1C1-PCA1000000000](#) [L1C1-BLU1000000000](#) [L1C1-RNG1000000000](#) [L1C1-CYN1000000000](#) [L1C1-RYL1000000000](#) [L1C1-RED1000000000](#) [L1C1-4070000000000](#) [L1C1-GRN1000000000](#) [L1C1-AMB1000000000](#) [L1C1-MNT1000000000](#) [L1C1-LME1000000000](#) [L1C1-FRD1000000000](#) [L1C1-2780000000000](#) [L1C1-4080000000000](#) [L1C1-3080000000000](#) [L1C1-5790000000000](#) [L1C1-6570000000000](#) [L1C1-DRD1000000000](#) [L1C1-2280000000000](#) [L1C1-3090000000000](#) [L1C1-4090000000000](#) [L1C1-VLT1000000000](#) [L1C1-2790000000000](#) [L1C1-5070000000000](#) [L1C1-3580000000000](#) [L1C1-PCB1000000000](#) [L1C1-MGO1000000000](#)