



Digital Transistors (Built-in Resistors)

DTC143EM/DTC143EE/DTC143EUA DTC143EKA /DTC143ECA/DTC143ESA

DIGITAL TRANSISTOR (NPN)



FEATURES

- Built-in bias resistors enable the configuration of an inverter circuit without connecting external input resistors(see equivalent circuit)
- The bias resistors consist of thin-film resistors with complete isolation to allow negative biasing of the input.They also have the advantage of almost completely eliminating parasitic effects
- Only the on/off conditions need to be set for operation, making device design easy

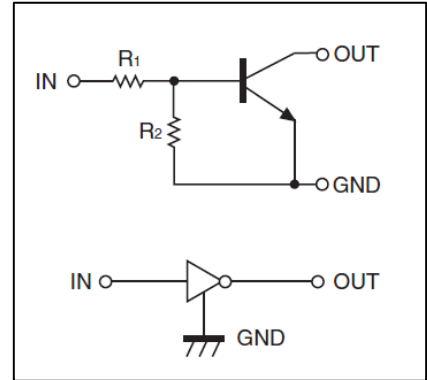
• Equivalent Circuit

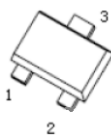
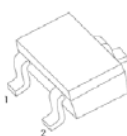
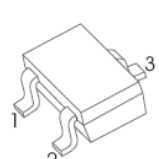
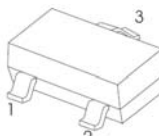
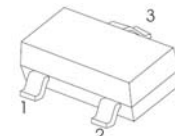

PIN CONNENCTIONS and MARKING

<p>DTC143EM</p>  <p>SOT-723</p> <p>1. IN 2. GND 3. OUT</p> <p>MARKING: 23</p>	<p>DTC143EE</p>  <p>SOT-523</p> <p>1. IN 2. GND 3. OUT</p> <p>MARKING: 23</p>
<p>DTC143EUA</p>  <p>SOT-323</p> <p>1. IN 2. GND 3. OUT</p> <p>MARKING: 23</p>	<p>DTC143EKA</p>  <p>SOT-23-3L</p> <p>1. IN 2. GND 3. OUT</p> <p>MARKING: 23</p>
<p>DTC143ECA</p>  <p>SOT-23</p> <p>1. IN 2. GND 3. OUT</p> <p>MARKING: 23</p>	<p>DTC143ESA</p>  <p>TO-92S</p> <p>1. GND 2. OUT 3. IN</p>

MAXIMUM RATINGS(Ta=25°C unless otherwise noted)

Symbol	Parameter	Limits(DTC143E□)						Unit
		M	E	UA	KA	CA	SA	
V _{CC}	Supply Voltage	50						V
V _{IN}	Input Voltage	-10~+30						V
I _O	Output Current	100						mA
P _D	Power Dissipation	100	150	200	200	200	300	mW
T _J	Junction Temperature	150						°C
T _{stg}	Storage Temperature	-55~+150						°C

ELECTRICAL CHARACTERISTICS (Ta=25°C unless otherwise specified)

Parameter	Symbol	Conditions	Min	Typ	Max	Unit
Input voltage	V _{I(off)}	V _{CC} =5V, I _O =100μA	0.5			V
	V _{I(on)}	V _O =0.3V, I _O =20mA			3	V
Output voltage	V _{O(on)}	I _O /I _I =10mA/0.5mA			0.3	V
Input current	I _I	V _I =5V			1.8	mA
Output current	I _{O(off)}	V _{CC} =50V, V _I =0			0.5	μA
DC current gain	G _I	V _O =5V, I _O =10mA	20			
Input resistance	R ₁		3.29	4.7	6.11	kΩ
Resistance ratio	R ₂ /R ₁		0.8	1	1.2	
Transition frequency	f _T	V _O =10V, I _O =5mA, f=100MHz		250		MHz

Typical Characteristics

DTC143EXX

