

PROTECTION PRODUCTS

Description

μClamp® TVS diodes are designed to protect sensitive electronics from damage or latch-up due to EOS, lightning, CDE, and ESD. They feature large cross-sectional area junctions for conducting high transient currents. These devices offer desirable characteristics for board level protection including fast response time, low operating and clamping voltage, and no device degradation.

μClamp®xx61P series are designed for use in harsh transient environments. They feature extremely good protection characteristics highlighted by high surge current capability, low peak ESD clamping voltage, and high ESD withstand voltage. Device options are available for protecting data or power lines operating at 5V to 60V.

μClamp®xx61P are in a 2-pin SLP1608P2 package measuring 1.6 x 0.8 mm with a nominal height of 0.50mm. The leads are finished with lead-free NiPdAu. High surge current capability and low clamping voltage making them ideal for protecting VBus, battery, and other power lines in consumer and industrial electronics.

Package Dimension

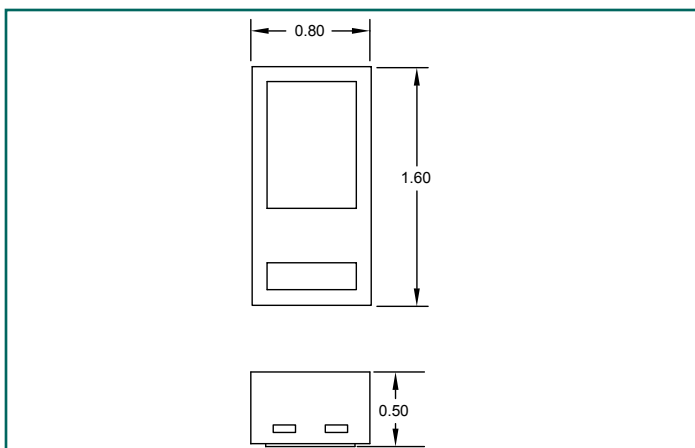

Features

- Transient Protection to
 - ♦ IEC 61000-4-2 (ESD) 30kV (Air), 30kV (Contact)
 - ♦ IEC 61000-4-4 (EFT) 4kV (5/50ns)
 - ♦ IEC 61000-4-5 (Lightning) 8-80A (8/20μs)
- Protects one data or power line
- Working voltage options: 5V, 10V, 12V, 15V, 24V, 30V, 36V, 40V, 60V
- Low leakage current
- High peak pulse current capability
- Solid-state silicon-avalanche technology

Mechanical Characteristics

- SLP1608P2 package
- Pb-Free, Halogen Free, RoHS/WEEE compliant
- Nominal Dimensions: 1.6 x 0.8 x 0.50 mm
- Lead Finish: NiPdAu
- Marking: Marking code
- Packaging: Tape and Reel

Applications

- Cellular Handsets
- Industrial Equipment
- Microcontroller RESET and IRQ Pins
- USB Voltage Bus
- Battery protection
- Tablet PC
- CCTV Cameras
- Instrumentation

Schematic & Pin Configuration

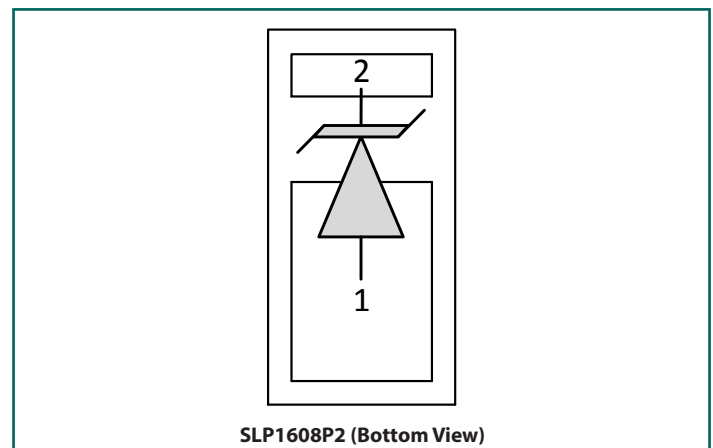

Absolute Maximum Ratings

Rating	Symbol	Value	Units
Peak Pulse Power (tp = 8/20μs)	P _{PK}	1200-1600	W
Peak Pulse Current (tp = 8/20μs)	I _{PP}	8-80	A
ESD per IEC 61000-4-2 (Contact) ⁽¹⁾ ESD per IEC 61000-4-2 (Air) ⁽¹⁾	V _{ESD}	±30 ±30	kV
Operating Temperature	T _J	-40 to +125	°C
Storage Temperature	T _{STG}	-55 to +150	°C

Electrical Characteristics (T=25°C unless otherwise specified)

μClamp0561P						
Parameter	Symbol	Conditions	Min.	Typ.	Max.	Units
Reverse Stand-Off Voltage	V _{RWM}	-40°C to 125°C, Pin 2 to Pin 1			5	V
Reverse Breakdown Voltage	V _{BR}	I _t = 1mA, Pin 2 to Pin 1	6	7	9	V
Reverse Leakage Current	I _R	V _{RWM} = 5V T = 25°C		50	300	nA
Peak Pulse Current	I _{PP}	tp = 8/20μs			80	A
Clamping Voltage ⁽²⁾	V _C	I _{PP} = 40A, tp = 8/20μs, Pin 2 to Pin 1			12	V
Clamping Voltage ⁽²⁾	V _C	I _{PP} = 80A, tp = 8/20μs, Pin 2 to Pin 1			15	V
Dynamic Resistance ^{(3), (4)}	R _{DYN}	tp = 0.2/100ns (TLP), Pin 2 to Pin 1		0.05		Ohms
Junction Capacitance	C _J	V _R = 0V, f = 1MHz Pin 2 to Pin 1 T = 25°C			800	pF

Notes:

(1): ESD Gun return path to Ground Reference Plane (GRP)

(2): Tested using a constant current source

(3): Transmission Line Pulse Test (TLP) Settings: tp = 100ns, tr = 0.2ns, I_{TLP} and V_{TLP} averaging window: t₁ = 70ns to t₂ = 90ns.

(4): Dynamic resistance calculated from I_{TLP} = 4A to I_{TLP} = 16A

Electrical Characteristics (T=25°C unless otherwise specified)

μClamp1061P						
Parameter	Symbol	Conditions	Min.	Typ.	Max.	Units
Reverse Stand-Off Voltage	V_{RWM}	-40°C to 125°C, Pin 2 to Pin 1			10	V
Reverse Breakdown Voltage	V_{BR}	$I_t = 1\text{mA}$, Pin 2 to Pin 1	12	13.5	15.5	V
Reverse Leakage Current	I_R	$V_{RWM} = 10\text{V}$ T = 25°C		<10	100	nA
Peak Pulse Current	I_{PP}	tp = 8/20μs			60	A
Clamping Voltage ⁽²⁾	V_C	$I_{PP} = 10\text{A}$, tp = 8/20μs, Pin 2 to Pin 1			17	V
Clamping Voltage ⁽²⁾	V_C	$I_{PP} = 60\text{A}$, tp = 8/20μs, Pin 2 to Pin 1			25	V
Dynamic Resistance ^{(3), (4)}	R_{DYN}	tp = 0.2/100ns (TLP), Pin 2 to Pin 1		0.05		Ohms
Junction Capacitance	C_J	$V_R = 0\text{V}$, f = 1MHz Pin 2 to Pin 1 T = 25°C			350	pF

μClamp1261P						
Parameter	Symbol	Conditions	Min.	Typ.	Max.	Units
Reverse Stand-Off Voltage	V_{RWM}	-40°C to 125°C, Pin 2 to Pin 1			12	V
Reverse Breakdown Voltage	V_{BR}	$I_t = 1\text{mA}$, Pin 2 to Pin 1	14	16.5	19	V
Reverse Leakage Current	I_R	$V_{RWM} = 12\text{V}$ T = 25°C		<10	100	nA
Peak Pulse Current	I_{PP}	tp = 8/20μs			45	A
Clamping Voltage ⁽²⁾	V_C	$I_{PP} = 10\text{A}$, tp = 8/20μs, Pin 2 to Pin 1			25	V
Clamping Voltage ⁽²⁾	V_C	$I_{PP} = 45\text{A}$, tp = 8/20μs, Pin 2 to Pin 1			33	V
Dynamic Resistance ^{(3), (4)}	R_{DYN}	tp = 0.2/100ns (TLP), Pin 2 to Pin 1		0.05		Ohms
Junction Capacitance	C_J	$V_R = 0\text{V}$, f = 1MHz Pin 2 to Pin 1 T = 25°C			275	pF

Electrical Characteristics (T=25°C unless otherwise specified)

μClamp1561P						
Parameter	Symbol	Conditions	Min.	Typ.	Max.	Units
Reverse Stand-Off Voltage	V_{RWM}	-40°C to 125°C, Pin 2 to Pin 1			15	V
Reverse Breakdown Voltage	V_{BR}	$I_t = 1\text{ mA}$, Pin 2 to Pin 1	17.5	20	23	V
Reverse Leakage Current	I_R	$V_{RWM} = 15\text{ V}$ $T = 25^\circ\text{C}$		<10	100	nA
Peak Pulse Current	I_{PP}	$t_p = 8/20\mu\text{s}$			40	A
Clamping Voltage ⁽²⁾	V_C	$I_{PP} = 10\text{ A}$, $t_p = 8/20\mu\text{s}$, Pin 2 to Pin 1			28	V
Clamping Voltage ⁽²⁾	V_C	$I_{PP} = 40\text{ A}$, $t_p = 8/20\mu\text{s}$, Pin 2 to Pin 1			40	V
Dynamic Resistance ^{(3), (4)}	R_{DYN}	$t_p = 0.2/100\text{ ns}$ (TLP), Pin 2 to Pin 1		0.05		Ohms
Junction Capacitance	C_J	$V_R = 0\text{ V}$, $f = 1\text{ MHz}$ Pin 2 to Pin 1 $T = 25^\circ\text{C}$			220	pF

μClamp2461P						
Parameter	Symbol	Conditions	Min.	Typ.	Max.	Units
Reverse Stand-Off Voltage	V_{RWM}	-40°C to 125°C, Pin 2 to Pin 1			24	V
Reverse Breakdown Voltage	V_{BR}	$I_t = 1\text{ mA}$, Pin 2 to Pin 1	27	32	36	V
Reverse Leakage Current	I_R	$V_{RWM} = 24\text{ V}$ $T = 25^\circ\text{C}$		<10	100	nA
Peak Pulse Current	I_{PP}	$t_p = 8/20\mu\text{s}$			23	A
Clamping Voltage ⁽²⁾	V_C	$I_{PP} = 10\text{ A}$, $t_p = 8/20\mu\text{s}$, Pin 2 to Pin 1			50	V
Clamping Voltage ⁽²⁾	V_C	$I_{PP} = 23\text{ A}$, $t_p = 8/20\mu\text{s}$, Pin 2 to Pin 1			65	V
Dynamic Resistance ^{(3), (4)}	R_{DYN}	$t_p = 0.2/100\text{ ns}$ (TLP), Pin 2 to Pin 1		0.20		Ohms
Junction Capacitance	C_J	$V_R = 0\text{ V}$, $f = 1\text{ MHz}$ Pin 2 to Pin 1 $T = 25^\circ\text{C}$			165	pF

Electrical Characteristics (T=25°C unless otherwise specified)

μClamp3061P						
Parameter	Symbol	Conditions	Min.	Typ.	Max.	Units
Reverse Stand-Off Voltage	V_{RWM}	-40°C to 125°C, Pin 2 to Pin 1			30	V
Reverse Breakdown Voltage	V_{BR}	$I_t = 1\text{ mA}$, Pin 2 to Pin 1	34	40	42	V
Reverse Leakage Current	I_R	$V_{RWM} = 30\text{ V}$ $T = 25^\circ\text{C}$		<10	100	nA
Peak Pulse Current	I_{PP}	$t_p = 8/20\mu\text{s}$			18	A
Clamping Voltage ⁽²⁾	V_C	$I_{PP} = 10\text{ A}$, $t_p = 8/20\mu\text{s}$, Pin 2 to Pin 1			55	V
Clamping Voltage ⁽²⁾	V_C	$I_{PP} = 18\text{ A}$, $t_p = 8/20\mu\text{s}$, Pin 2 to Pin 1			65	V
Dynamic Resistance ^{(3), (4)}	R_{DYN}	$t_p = 0.2/100\text{ ns}$ (TLP), Pin 2 to Pin 1		0.25		Ohms
Junction Capacitance	C_J	$V_R = 0\text{ V}$, $f = 1\text{ MHz}$ Pin 2 to Pin 1 $T = 25^\circ\text{C}$			155	pF

μClamp3661P						
Parameter	Symbol	Conditions	Min.	Typ.	Max.	Units
Reverse Stand-Off Voltage	V_{RWM}	-40°C to 125°C, Pin 2 to Pin 1			36	V
Reverse Breakdown Voltage	V_{BR}	$I_t = 1\text{ mA}$, Pin 2 to Pin 1	37	40	44	V
Reverse Leakage Current	I_R	$V_{RWM} = 36\text{ V}$ $T = 25^\circ\text{C}$		<10	100	nA
Peak Pulse Current	I_{PP}	$t_p = 8/20\mu\text{s}$			18	A
Clamping Voltage ⁽²⁾	V_C	$I_{PP} = 2\text{ A}$, $t_p = 8/20\mu\text{s}$, Pin 2 to Pin 1			48	V
Clamping Voltage ⁽²⁾	V_C	$I_{PP} = 18\text{ A}$, $t_p = 8/20\mu\text{s}$, Pin 2 to Pin 1			70	V
Dynamic Resistance ^{(3), (4)}	R_{DYN}	$t_p = 0.2/100\text{ ns}$ (TLP), Pin 2 to Pin 1		0.25		Ohms
Junction Capacitance	C_J	$V_R = 0\text{ V}$, $f = 1\text{ MHz}$ Pin 2 to Pin 1 $T = 25^\circ\text{C}$			150	pF

Electrical Characteristics (T=25°C unless otherwise specified)

μClamp4061P						
Parameter	Symbol	Conditions	Min.	Typ.	Max.	Units
Reverse Stand-Off Voltage	V_{RWM}	-40°C to 125°C, Pin 2 to Pin 1			40	V
Reverse Breakdown Voltage	V_{BR}	$I_t = 1\text{mA}$, Pin 2 to Pin 1	45	50	55	V
Reverse Leakage Current	I_R	$V_{RWM} = 40\text{V}$ $T = 25^\circ\text{C}$		<10	100	nA
Peak Pulse Current	I_{PP}	$t_p = 8/20\mu\text{s}$			12	A
Clamping Voltage ⁽²⁾	V_C	$I_{PP} = 12\text{A}$, $t_p = 8/20\mu\text{s}$, Pin 2 to Pin 1			80	V
Dynamic Resistance ^{(3), (4)}	R_{DYN}	$t_p = 0.2/100\text{ns}$ (TLP), Pin 2 to Pin 1		0.35		Ohms
Junction Capacitance	C_J	$V_R = 0\text{V}$, $f = 1\text{MHz}$ Pin 2 to Pin 1 $T = 25^\circ\text{C}$			125	pF

μClamp6061P						
Parameter	Symbol	Conditions	Min.	Typ.	Max.	Units
Reverse Stand-Off Voltage	V_{RWM}	-40°C to 125°C, Pin 2 to Pin 1			60	V
Reverse Breakdown Voltage	V_{BR}	$I_t = 1\text{mA}$, Pin 2 to Pin 1	65	70	85	V
Reverse Leakage Current	I_R	$V_{RWM} = 60\text{V}$ $T = 25^\circ\text{C}$		<10	100	nA
Peak Pulse Current	I_{PP}	$t_p = 8/20\mu\text{s}$			8	A
Clamping Voltage ⁽²⁾	V_C	$I_{PP} = 8\text{A}$, $t_p = 8/20\mu\text{s}$, Pin 2 to Pin 1			105	V
Dynamic Resistance ^{(3), (4)}	R_{DYN}	$t_p = 0.2/100\text{ns}$ (TLP) Pin 2 to Pin 1		0.45		Ohms
Junction Capacitance	C_J	$V_R = 0\text{V}$, $f = 1\text{MHz}$ Pin 2 to Pin 1 $T = 25^\circ\text{C}$			110	pF

Typical Characteristics

Clamping Voltage vs. Peak Pulse Current ($V_{RWM} = 5V - 15V$)

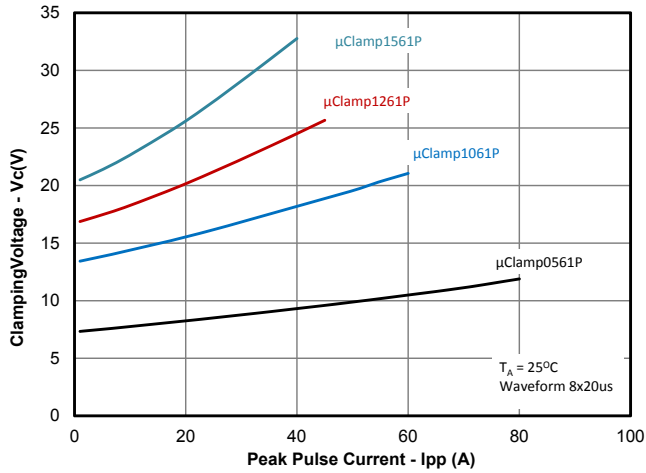

Clamping Voltage vs. Peak Pulse Current ($V_{RWM} = 24V - 60V$)

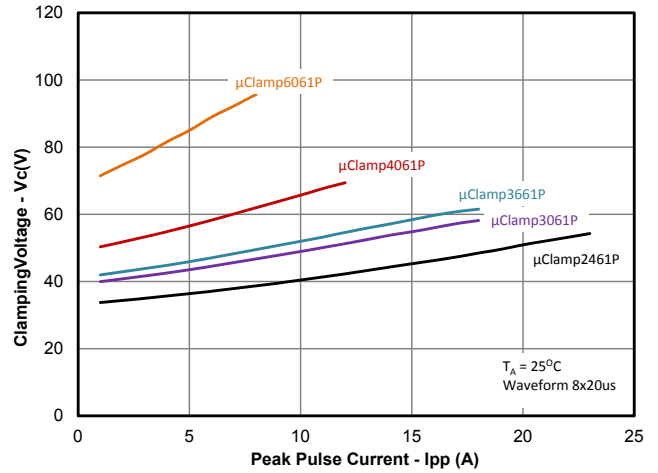

ESD Clamping (8kV Contact per IEC 61000-4-2)

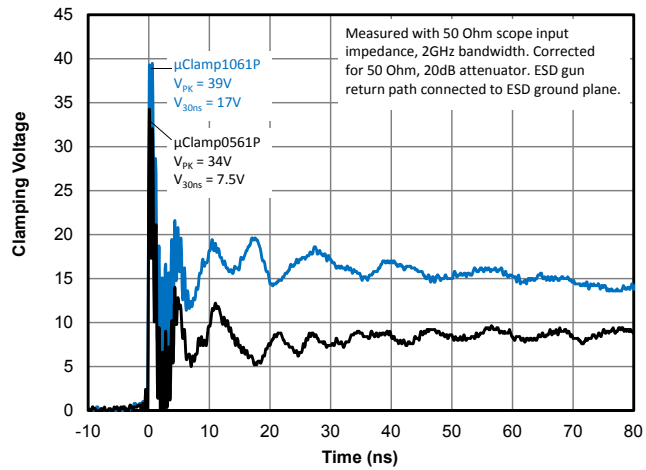

ESD Clamping (8kV Contact per IEC 61000-4-2)

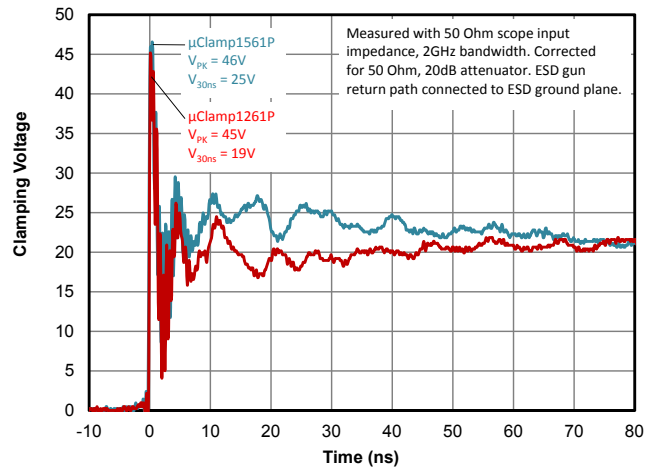

ESD Clamping (8kV Contact per IEC 61000-4-2)

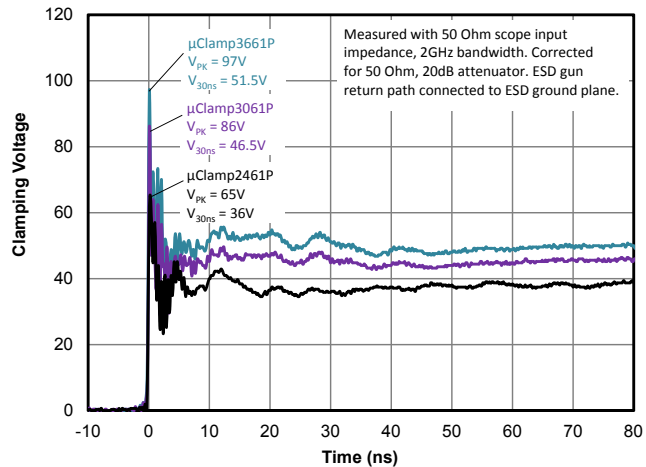

ESD Clamping (8kV Contact per IEC 61000-4-2)

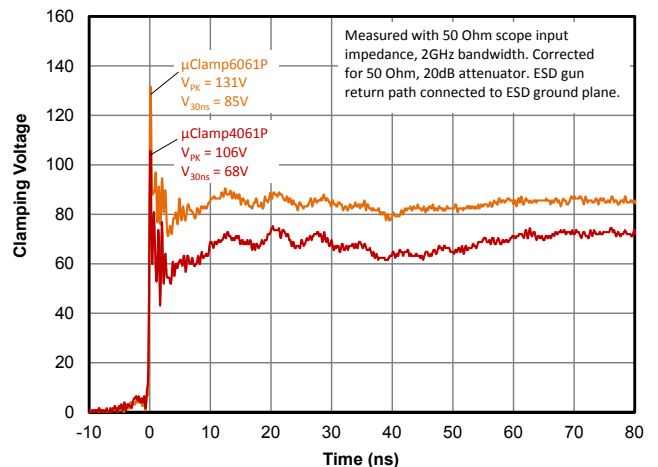

Typical Characteristics

ESD Clamping (-8kV Contact per IEC 61000-4-2)

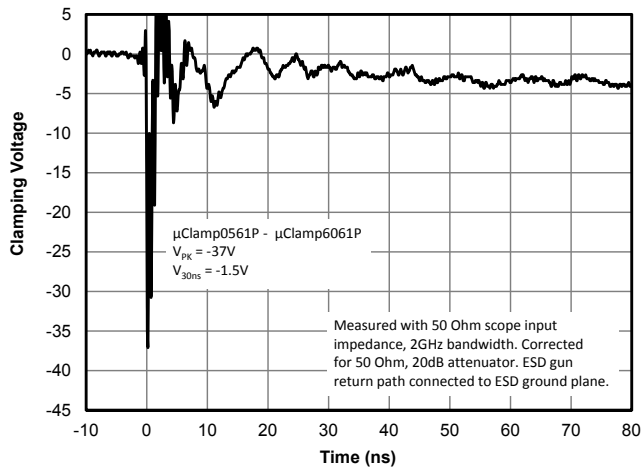

Forward Voltage vs. Peak Pulse Current ($V_{RWM} = 5V - 60V$)

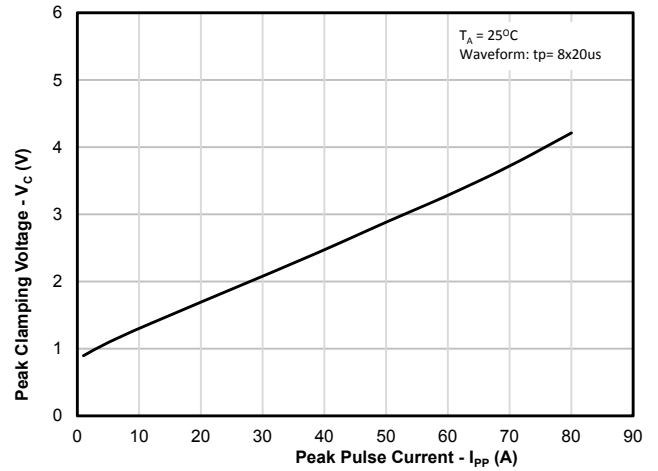

TLP Characteristic (Positive Pulse) - ($V_{RWM} = 5V - 15V$)

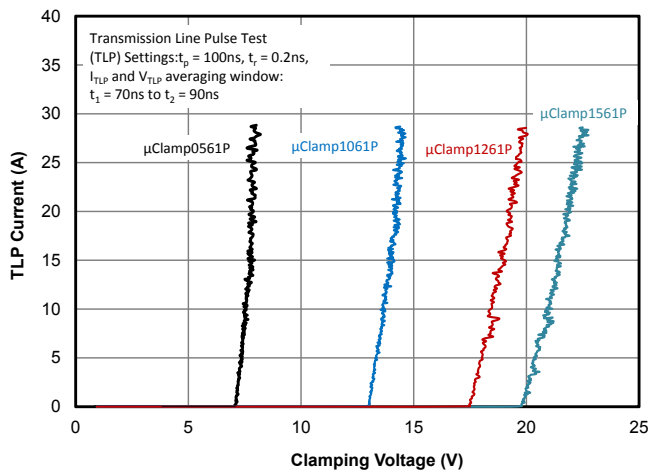

TLP Characteristic (Positive Pulse) - ($V_{RWM} = 24V - 60V$)

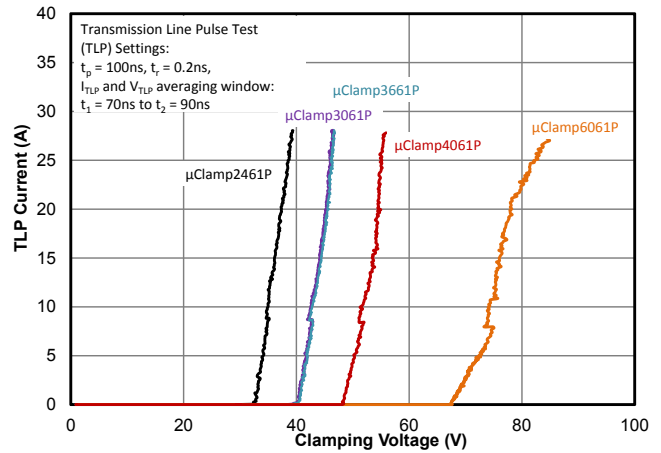

Capacitance vs. Reverse Voltage - ($V_{RWM} = 5V - 15V$)

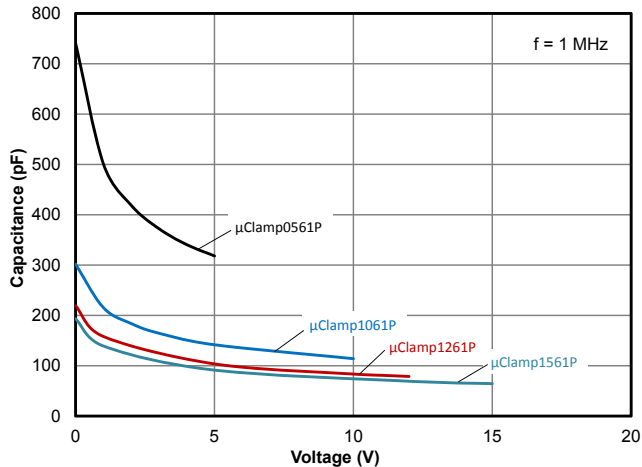

Capacitance vs. Reverse Voltage - ($V_{RWM} = 24V - 60V$)

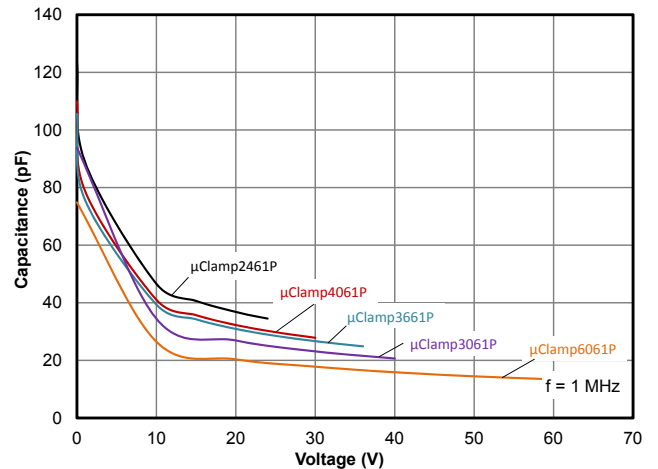

Application Information

Assembly Guidelines

The figure at the right details Semtech’s recommended mounting pattern. Recommended assembly guidelines are shown in Table 1. Note that these are only recommendations and should serve only as a starting point for design since there are many factors that affect the assembly process. Exact manufacturing parameters will require some experimentation to get the desired solder application. Semtech’s recommended mounting pattern is based on the following design guidelines:

Land Pattern

The recommended land pattern follows IPC standards and is designed for maximum solder coverage. Detailed dimensions are shown elsewhere in this document.

Solder Stencil

Stencil design is one of the key factors which will determine the volume of solder paste deposited onto the land pad. The area ratio of the stencil aperture will determine how well the stencil will print. The area ratio takes into account the aperture shape, aperture size, and stencil thickness. An area ratio of 0.70 – 0.75 is preferred for the subject package. The area ratio of a rectangular aperture is given as:

$$\text{Area Ratio} = (L * W) / (2 * (L + W) * T)$$

Where:

- L = Aperture Length
- W = Aperture Width
- T = Stencil Thickness

Semtech recommends a stencil thickness of 0.125mm for this device. The stencil should be laser cut with electro-polished finish. The stencil should have a positive taper of approximately 5 degrees. Electro polishing and tapering the walls results in reduced surface friction and better paste release. Since this device has uneven pad sizes, the recommended stencil opening is 10% smaller than the size of the large pad and 25um larger than the size of the small pad. This is done to control solder height and keep the part planar during reflow. Solder paste with Type 3 or smaller particles are recommended.

Recommended Mounting Pattern

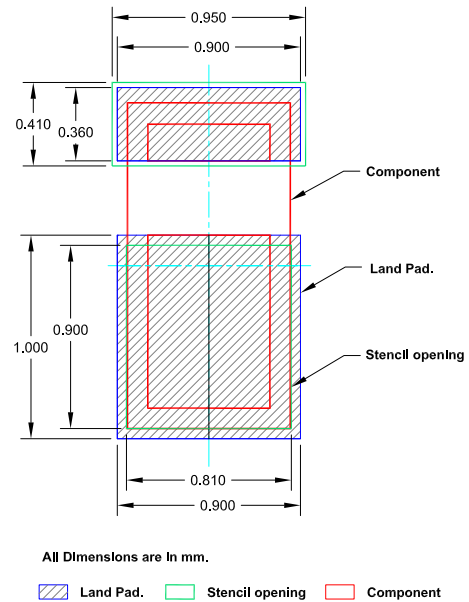

Assembly Parameter	Recommendation
Solder Stencil Design	Laser Cut, Electro-Polished
Aperture Shape	Rectangular
Solder Stencil Thickness	0.125mm (0.005")
Solder Paste Type	Type 3 size sphere or smaller
Solder Reflow Profile	Per JEDEC J-STD-020
PCB Solder pad Design	Non-Solder Mask Defined
PCB Pad Finish	OSP or NiAu

Outline Drawing - SLP1608P2

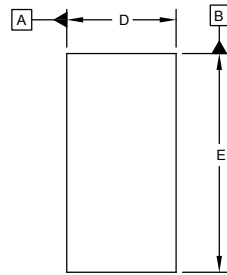

DIM	MILLIMETERS		
	MIN	NOM	MAX
A	0.47	0.50	0.53
A1	0.00	0.02	0.05
b	0.95	0.80	0.85
D	0.75	0.80	0.85
E	1.55	1.60	1.65
L	0.80	0.85	0.90
L1	0.13	0.18	0.23
N	2		
aaa	0.08		
bbb	0.10		

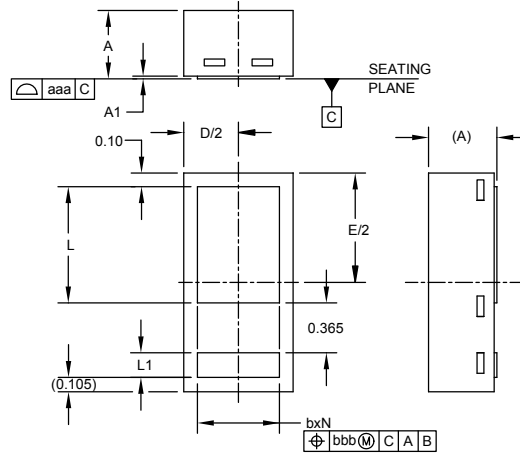

NOTES:
 1. CONTROLLING DIMENSIONS ARE IN MILLIMETERS (ANGLES IN DEGREES).

Land Pattern - SLP1608P2

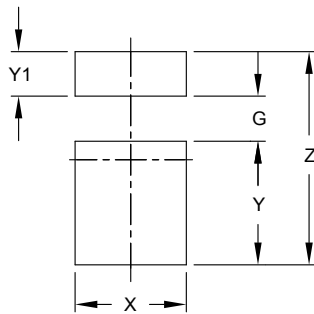

DIM	MILLIMETERS
	G
X	0.90
Y	1.00
Y1	0.36
Z	1.725

NOTES:
 1. CONTROLLING DIMENSIONS ARE IN MILLIMETERS (ANGLES IN DEGREES).
 2. THIS LAND PATTERN IS FOR REFERENCE PURPOSES ONLY. CONSULT YOUR MANUFACTURING GROUP TO ENSURE YOUR COMPANY'S MANUFACTURING GUIDELINES ARE MET.

Marking

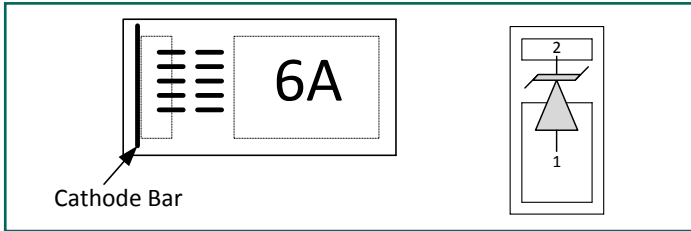

Notes:

- 1) Dashes represent matrix date code
- 2) See ordering information for part specific marking codes

Ordering Information

Part Number	Marking Code	Working Voltage	Qty per 7" Reel
μ Clamp0561P.TNT	6A	5V	10,000
μ Clamp1061P.TNT	6B	10V	10,000
μ Clamp1261P.TNT	6C	12V	10,000
μ Clamp1561P.TNT	6D	15V	10,000
μ Clamp2461P.TNT	6F	24V	10,000
μ Clamp3061P.TNT	6G	30V	10,000
μ Clamp3661P.TNT	6H	36V	10,000
μ Clamp4061P.TNT	6J	40V	10,000
μ Clamp6061P.TNT	6K	60V	10,000

Notes:

- 1) MicroClamp, uClamp and μ Clamp are trademarks of Semtech Corporation

Tape and Reel Specification

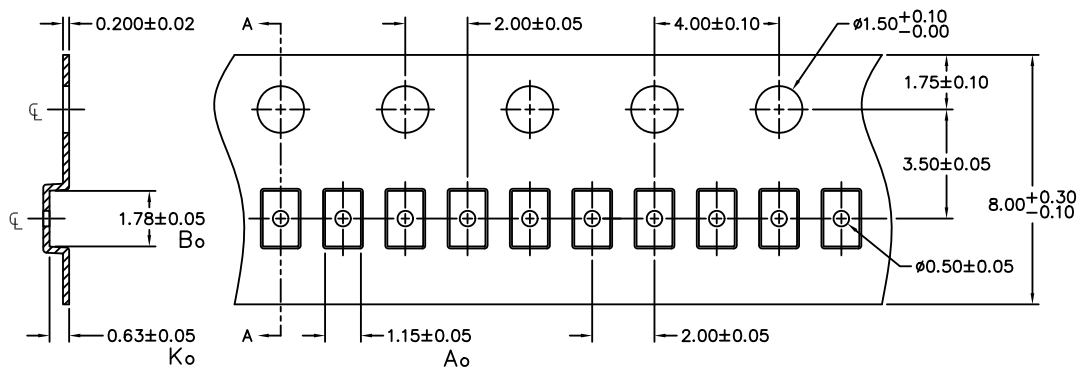

SECTION A-A

NOTES: 1.) ALL DIMENSIONS IN MILLIMETERS UNLESS OTHERWISE SPECIFIED.

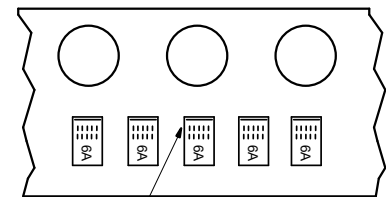

Cathode Location
(Towards Sprocket Holes)



Important Notice

Information relating to this product and the application or design described herein is believed to be reliable, however such information is provided as a guide only and Semtech assumes no liability for any errors in this document, or for the application or design described herein. Semtech reserves the right to make changes to the product or this document at any time without notice. Buyers should obtain the latest relevant information before placing orders and should verify that such information is current and complete. Semtech warrants performance of its products to the specifications applicable at the time of sale, and all sales are made in accordance with Semtech's standard terms and conditions of sale.

SEMTECH PRODUCTS ARE NOT DESIGNED, INTENDED, AUTHORIZED OR WARRANTED TO BE SUITABLE FOR USE IN LIFE-SUPPORT APPLICATIONS, DEVICES OR SYSTEMS, OR IN NUCLEAR APPLICATIONS IN WHICH THE FAILURE COULD BE REASONABLY EXPECTED TO RESULT IN PERSONAL INJURY, LOSS OF LIFE OR SEVERE PROPERTY OR ENVIRONMENTAL DAMAGE. INCLUSION OF SEMTECH PRODUCTS IN SUCH APPLICATIONS IS UNDERSTOOD TO BE UNDERTAKEN SOLELY AT THE CUSTOMER'S OWN RISK. Should a customer purchase or use Semtech products for any such unauthorized application, the customer shall indemnify and hold Semtech and its officers, employees, subsidiaries, affiliates, and distributors harmless against all claims, costs damages and attorney fees which could arise.

The Semtech name and logo are registered trademarks of the Semtech Corporation. All other trademarks and trade names mentioned may be marks and names of Semtech or their respective companies. Semtech reserves the right to make changes to, or discontinue any products described in this document without further notice. Semtech makes no warranty, representation or guarantee, express or implied, regarding the suitability of its products for any particular purpose. All rights reserved.

© Semtech 2017

Contact Information

Semtech Corporation
200 Flynn Road, Camarillo, CA 93012
Phone: (805) 498-2111, Fax: (805) 498-3804
www.semtech.com

Mouser Electronics

Authorized Distributor

Click to View Pricing, Inventory, Delivery & Lifecycle Information:

[Semtech:](#)

[UCLAMP0561P.TNT](#) [UCLAMP1061P.TNT](#) [UCLAMP1261P.TNT](#) [UCLAMP1561P.TNT](#) [UCLAMP2461P.TNT](#)
[UCLAMP3061P.TNT](#) [UCLAMP3661P.TNT](#) [UCLAMP4061P.TNT](#) [UCLAMP6061P.TNT](#)