

65W Boost Converter: Non-Isolated DC-DC Modules

8Vdc –16Vdc input; 32Vdc to 54Vdc output; 65W Output power (max.)

TUNABLE LOOP™



RoHS Compliant

Applications

- Industrial equipment
- Distributed power architectures
- Telecommunications equipment

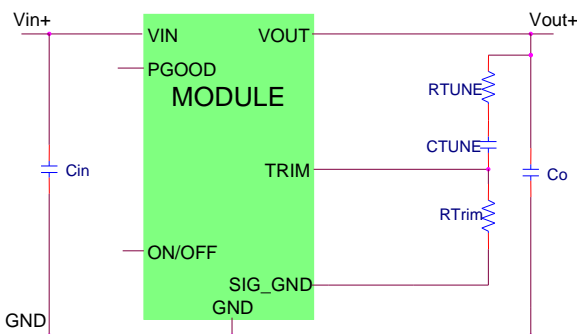

Features

- Compliant to RoHS Directive 2011/65/EU and amended Directive (EU) 2015/863
- Compliant to IPC-9592 (September 2008), Category 2, Class II
- Compatible in a Pb-free or SnPb reflow environment (Z versions)
- Compliant to REACH Directive (EC) No 1907/2006
- Wide Input voltage range (8Vdc-16Vdc)
- Output voltage programmable from 32 to 54Vdc via external resistor
- Tunable Loop™ to optimize dynamic output voltage response
- Power Good signal
- Output overcurrent protection (non-latching)
- Over temperature protection
- Remote On/Off
- Ability to sink and source current
- Support Pre-biased Output
- Optimized for conduction-cooled applications
- Small size: 27.9 mm x 11.4 mm x 8.5 mm(MAX) (1.1 in x 0.45 in x 0.335 in)
- Wide operating temperature range [-40°C to 85°C]
- ANSI/UL* 62368-1 and CAN/ CSA† C22.2 No. 62368-1 Recognized, DIN VDE‡ 0868-1/A11:2017 (EN62368-1:2014/A11:2017)
- ISO** 9001 and ISO 14001 certified manufacturing facilities

Description

The Boost power modules are non-isolated dc-dc converters that can deliver up to 65W of output power. The module can operate over a wide range of input voltage ($V_{IN} = 8\text{Vdc}-16\text{Vdc}$) and provide an adjustable 32 to 54VDC output. The output voltage is programmable via an external resistor. Features include remote On/Off, over current and over temperature protection. The module also includes the Tunable Loop™ feature that allows the user to optimize the dynamic response of the converter to match the load with reduced amount of output capacitance leading to savings on cost and PWB area.

* UL is a registered trademark of Underwriters Laboratories, Inc.

† CSA is a registered trademark of Canadian Standards Association.

‡ VDE is a trademark of Verband Deutscher Elektrotechniker e.V.

** ISO is a registered trademark of the International Organization of Standards

65W Boost Converter: Non-Isolated DC-DC Power Modules

8Vdc –16Vdc input; 32Vdc – 54Vdc output, 65W output power (max.)

Absolute Maximum Ratings

Stresses in excess of the absolute maximum ratings can cause permanent damage to the device. These are absolute stress ratings only, functional operation of the device is not implied at these or any other conditions in excess of those given in the operations sections of the data sheet. Exposure to absolute maximum ratings for extended periods can adversely affect the device reliability.

Parameter	Device	Symbol	Min	Max	Unit
Input Voltage Continuous	All	V_{IN}	-0.3	18	V
Operating Ambient Temperature (see Thermal Considerations section)	All	T_A	-40	85	°C
Storage Temperature	All	T_{stg}	-55	125	°C

Electrical Specifications

Unless otherwise indicated, specifications apply over all operating input voltage, resistive load, and temperature conditions.

Parameter	Device	Symbol	Min	Typ	Max	Unit
Operating Input Voltage	All	V_{IN}	8	—	16	Vdc
Maximum Input Current ($V_{IN}=8V, V_O=40V, I_O=I_{O,max}$)	All	I_{IN1max}			10	Adc
Input No Load Current ($V_{IN} = 12Vdc, I_O = 0$, module enabled)	$V_{O,set} = 32 Vdc$	$I_{IN, No load}$			125	mA
	$V_{O,set} = 54Vdc$	$I_{IN, No load}$			190	mA
Input Stand-by Current ($V_{IN} = 12Vdc$, module disabled)	All	$I_{IN, stand-by}$		5	10	mA
Inrush Transient	All	I_1^2t			1	A ² s
Input Reflected Ripple Current, peak-to-peak (5Hz to 20MHz, 1 μ H source impedance; $V_{IN} = 8$ to 16V, $I_O = I_{O,max}$; See Test Configurations)	All				285	mAp-p
Input Ripple Rejection (120Hz)	All			15		dB

65W Boost Converter: Non-Isolated DC-DC Power Modules

8Vdc –16Vdc input; 32Vdc – 54Vdc output, 65W output power (max.)

Electrical Specifications (continued)

Parameter	Device	Symbol	Min	Typ	Max	Unit
Output Voltage Set-point (with 0.1% tolerance for external resistor used to set output voltage)	All	$V_{o, set}$		1		% $V_{O, set}$
Output Voltage (Over all operating input voltage, resistive load, and temperature conditions until end of life)	All	$V_{o, set}$		3		% $V_{O, set}$
Adjustment Range (selected by an external resistor)	All	V_o	32		54	Vdc
Output Regulation						
Line ($V_{IN}=V_{IN, min}$ to $V_{IN, max}$)	All			+0.4		% $V_{O, set}$
Load ($I_o=I_{o, min}$ to $I_{o, max}$)	All			0.4		% $V_{O, set}$
Temperature ($T_{ref}=T_{A, min}$ to $T_{A, max}$)	All			0.4		% $V_{O, set}$
Input Noise on nominal input at 25°C ($V_{IN}=V_{IN, nom}$ and $I_o=I_{o, min}$ to $I_{o, max}$ $C_{in}=220\mu F$) Peak-to-Peak (Full Bandwidth) for all V_o	All		—	3%		mVpk-pk
Output Ripple and Noise on nominal output at 25°C ($V_{IN}=V_{IN, nom}$ and $I_o=I_{o, min}$ to $I_{o, max}$ $C_o=66\mu F$) Peak-to-Peak (Full bandwidth) Peak-to-Peak (20MHz)	All			300 90		mV _{pk-pk} mV _{pk-pk}
External Capacitance ¹ Without the Tunable Loop™ ESR ≥ 1 mΩ	All	$C_{o, max}$	10		100	μF
With the Tunable Loop™ ESR ≥ 0.15 mΩ	All	$C_{o, max}$	100		470	μF
ESR ≥ 10 mΩ	All	$C_{o, max}$			470	μF
Output power	All	P_o	0		65	Watts
Output Current	32Vout	I_o			2.03	A
	40Vout				1.63	
	48Vout				1.35	
	54Vout				1.2	
Output Current Limit Inception (Hiccup Mode) (current limit does not operate in sink mode)	All	$I_{o, lim}$		150		% $I_{o, max}$
Efficiency $V_{IN}=12Vdc$, $T_A=25^\circ C$ $I_o=I_{o, max}$, $V_o=V_{O, set}$	$V_o=32Vdc$	η		95		%
	$V_o=48Vdc$	η		93.8		%
	$V_o=54Vdc$	η		93.3		%
Switching Frequency	All	f_{sw}	—	260	—	kHz

¹ External capacitors may require using the new Tunable Loop™ feature to ensure that the module is stable as well as getting the best transient response. See the Tunable Loop™ section for details.

65W Boost Converter: Non-Isolated DC-DC Power Modules

8Vdc –16Vdc input; 32Vdc – 54Vdc output, 65W output power (max.)

General Specifications

Parameter	Device	Min	Typ	Max	Unit
Calculated MTBF ($I_o=0.8I_{o,max}$, $T_A=40^\circ\text{C}$) Telcordia Issue 3 Method 1 Case 3	All		47,243,971		Hours
Weight		—	5.6	—	g (oz.)

Feature Specifications

Unless otherwise indicated, specifications apply over all operating input voltage, resistive load, and temperature conditions. See Feature Descriptions for additional information.

Parameter	Device	Symbol	Min	Typ	Max	Unit
On/Off Signal Interface ($V_{IN}=V_{IN,min}$ to $V_{IN,max}$; open collector or equivalent, Signal referenced to GND)						
Device Code with no suffix – Negative Logic (See Ordering Information) (On/OFF pin is open collector/drain logic input with external pull-up resistor; signal referenced to GND)						
Logic High (Module OFF)						
Input High Current	All	I_{IH}	—	—	1	mA
Input High Voltage	All	V_{IH}	2.5	—	$V_{IN,max}$	Vdc
Logic Low (Module ON)						
Input low Current	All	I_{IL}	—	—	1	mA
Input Low Voltage	All	V_{IL}	-0.2	—	0.6	Vdc
Turn-On Delay and Rise Times						
($V_{IN}=V_{IN,nom}$, $I_o=I_{o,max}$, V_o to within $\pm 1\%$ of steady state)						
Case 1: On/Off input is enabled and then input power is applied (delay from instant at which $V_{IN} = V_{IN,min}$ until $V_o = 10\%$ of $(V_{o,set} - V_{in})$)	All	Tdelay1	—	24	—	msec
Case 2: Input power is applied for at least one second and then the On/Off input is enabled (delay from instant at which Von/Off is enabled until $V_o = 10\%$ of $(V_{o,set} - V_{in})$)	All	Tdelay1	—	24	—	msec
Output voltage Rise time (time for V_o to rise from 10% of $V_{o,set}$ to 90% of $(V_{o,set} - V_{in})$)	All	Trise1		32	—	msec
Output voltage overshoot ($T_A = 25^\circ\text{C}$ $V_{IN}= V_{IN,min}$ to $V_{IN,max}$, $I_o= I_{o,min}$ to $I_{o,max}$) With or without maximum external capacitance					3	% $V_{o,set}$

65W Boost Converter: Non-Isolated DC-DC Power Modules

8Vdc – 16Vdc input; 32Vdc – 54Vdc output, 65W output power (max.)

Feature Specifications (cont.)

Parameter	Device	Symbol	Min	Typ	Max	Units	
Over Temperature Protection (See Thermal Considerations section)	Open-Frame Applications	All	T _{ref}		120		°C
	Coldwall Applications				115		
Input Undervoltage Lockout							
Turn-on Threshold	All				7.7	Vdc	
Turn-off Threshold	All		6.9			Vdc	
Hysteresis	All			0.5		Vdc	
PGOOD (Power Good)							
Signal Interface Open Drain, V _{supply} ≤ 5VDC							
Overvoltage threshold for PGOOD ON	All			107.6		%V _{o, set}	
Overvoltage threshold for PGOOD OFF	All			112.8		%V _{o, set}	
Undervoltage threshold for PGOOD ON	All			92.2		%V _{o, set}	
Undervoltage threshold for PGOOD OFF	All			87.9		%V _{o, set}	
Pulldown resistance of PGOOD pin	All			94		Ω	
Sink current capability into PGOOD pin	All		6			mA	

65W Boost Converter: Non-Isolated DC-DC Power Modules

8Vdc – 16Vdc input; 32Vdc – 54Vdc output, 65W output power (max.)

Characteristic Curves

The following figures provide typical characteristics for the ABXS001at 32V_o and 25°C.

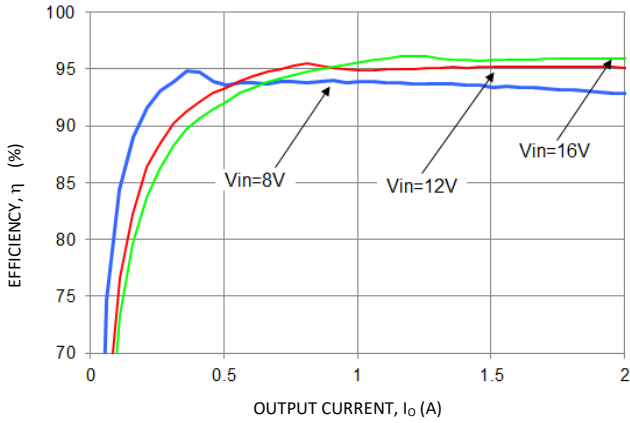

Figure 1. Converter Efficiency versus Output Current.

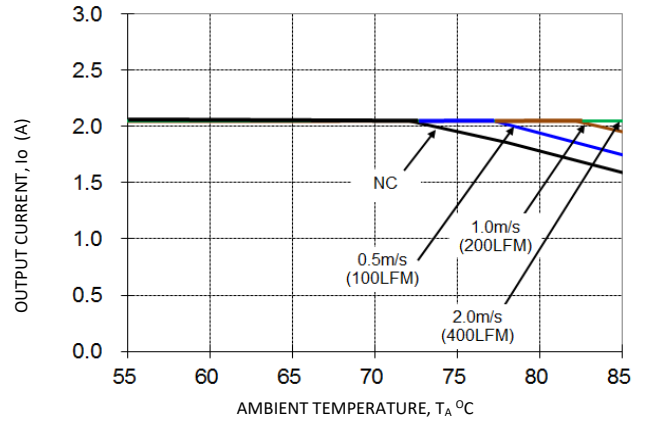

Figure 2. Derating Output Current versus Ambient Temperature and Airflow, VIN = 12V.

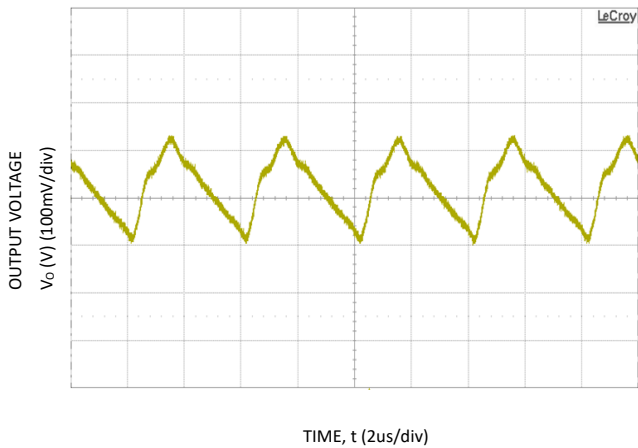

Figure 3. Typical output ripple and noise (C_o=66 μF ceramic, V_{in} = 12V, I_o = I_{o,max}).

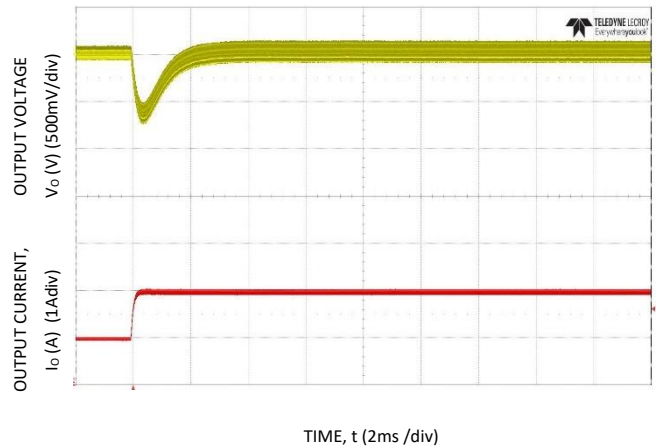

Figure 4. Transient Response to Dynamic Load Change from 50% to 100% at 12Vin, C_{out}=12x4.7uF, C_{Tune}=820pF, R_{Tune}=30.1k

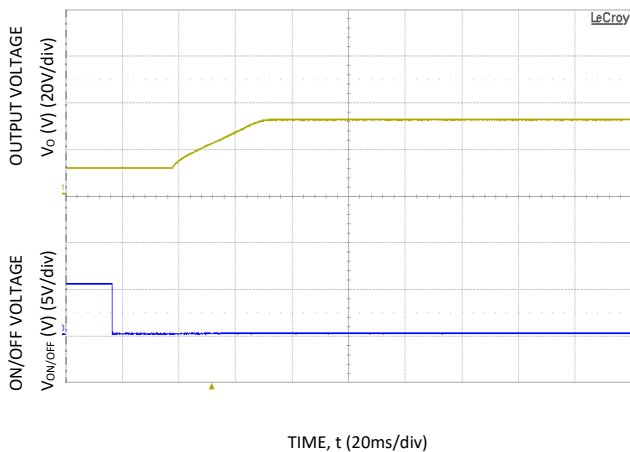

Figure 5. Typical Start-up Using On/Off Voltage (I_o = I_{o,max}).

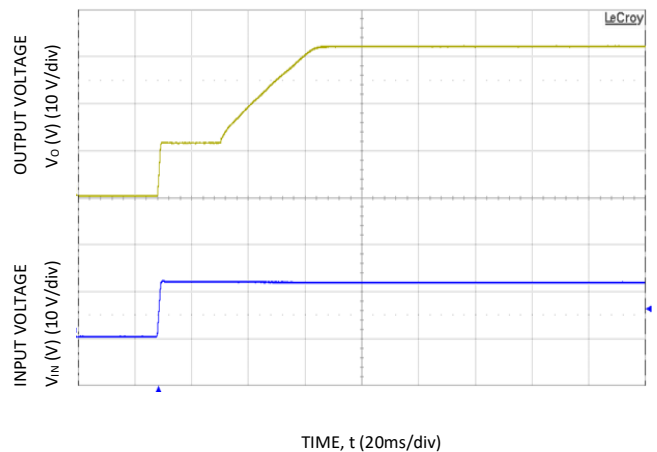

Figure 6. Typical Start-up Using Input Voltage (V_{in} = 12V, I_o = I_{o,max}).

65W Boost Converter: Non-Isolated DC-DC Power Modules

8Vdc – 16Vdc input; 32Vdc – 54Vdc output, 65W output power (max.)

Characteristic Curves

The following figures provide typical characteristics for the ABXS001at 40V_o and 25°C.

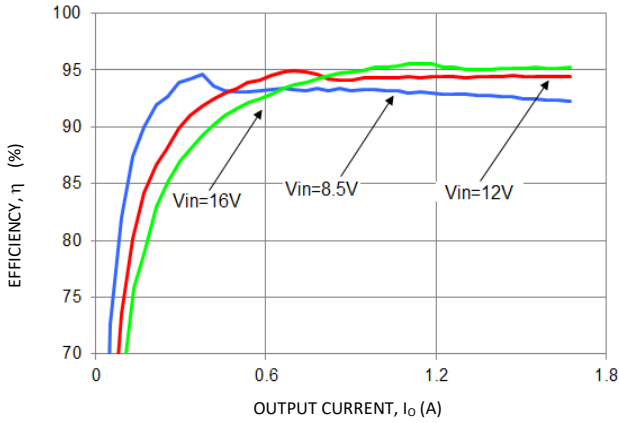

Figure 7. Converter Efficiency versus Output Current.

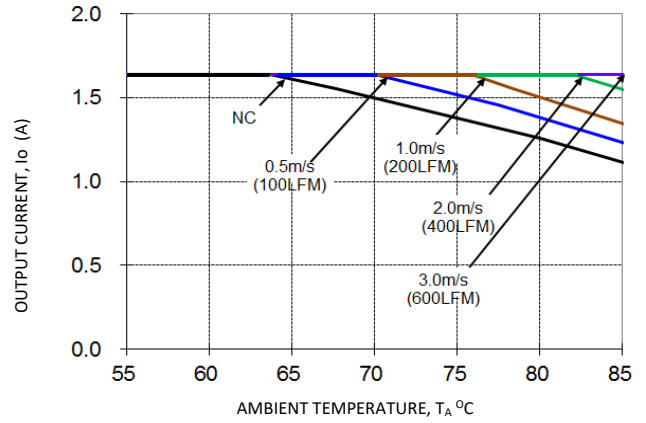

Figure 8. Derating Output Current versus Ambient Temperature and Airflow, VIN = 12V.

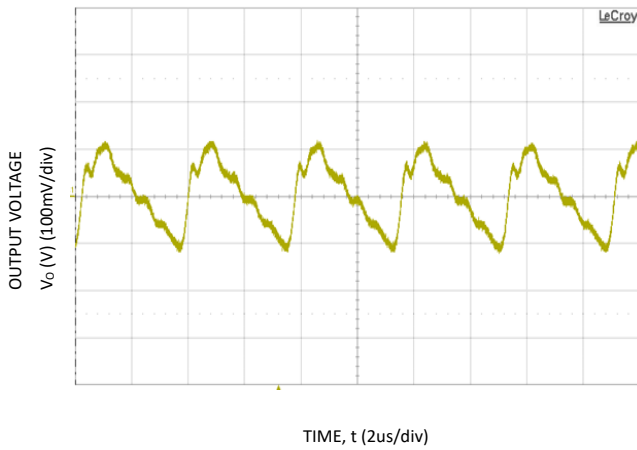

Figure 9. Typical output ripple and noise (C_o=66μF ceramic, V_{IN} = 12V, I_o = I_{o,max}).

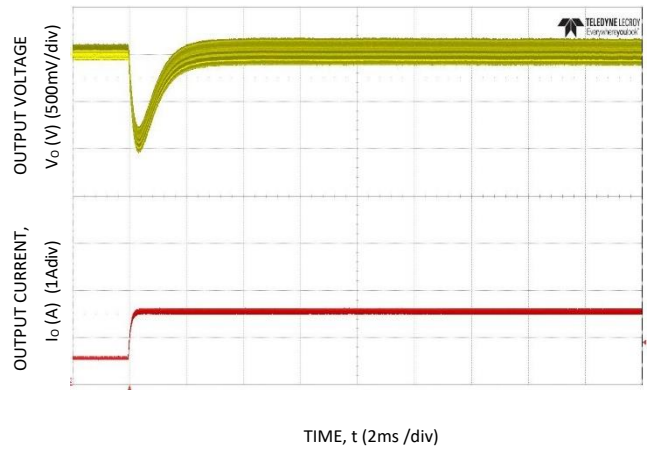

Figure 10. Transient Response to Dynamic Load Change from 0.6 to 1.6A at 12Vin, Cout=10x4.7uF, CTune=560pF, RTune=40.2k

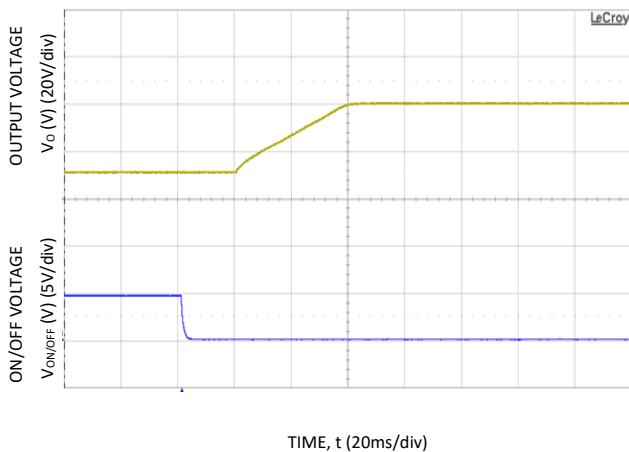

Figure 11. Typical Start-up Using On/Off Voltage (I_o = I_{o,max}).

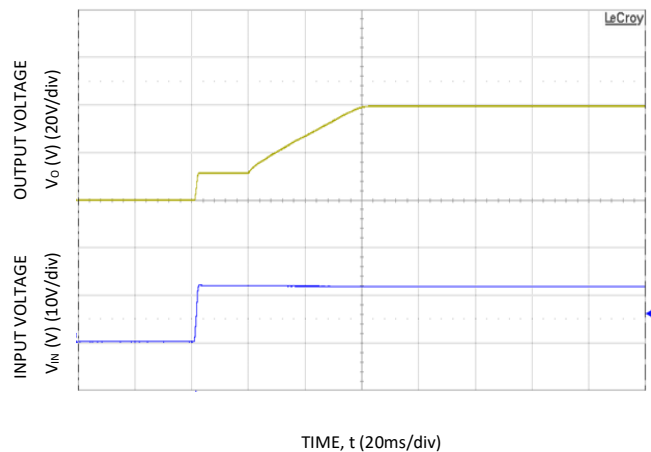

Figure 12. Typical Start-up Using Input Voltage (V_{IN} = 12V, I_o = I_{o,max}).

65W Boost Converter: Non-Isolated DC-DC Power Modules

8Vdc – 16Vdc input; 32Vdc – 54Vdc output, 65W output power (max.)

Characteristic Curves

The following figures provide typical characteristics for the ABXS001at 48Vo and 25°C.

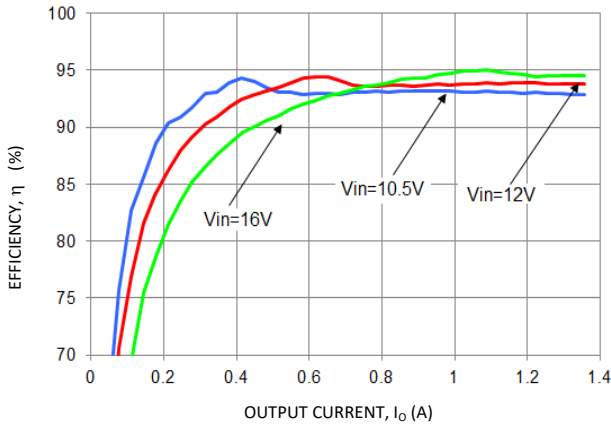

Figure 13. Converter Efficiency versus Output Current.

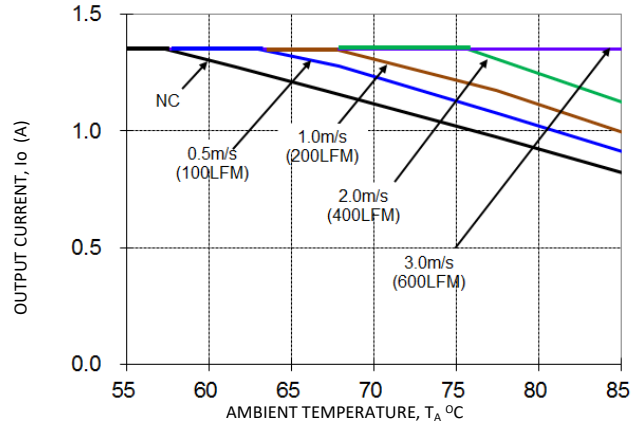

Figure 14. Derating Output Current versus Ambient Temperature and Airflow, VIN = 12V.

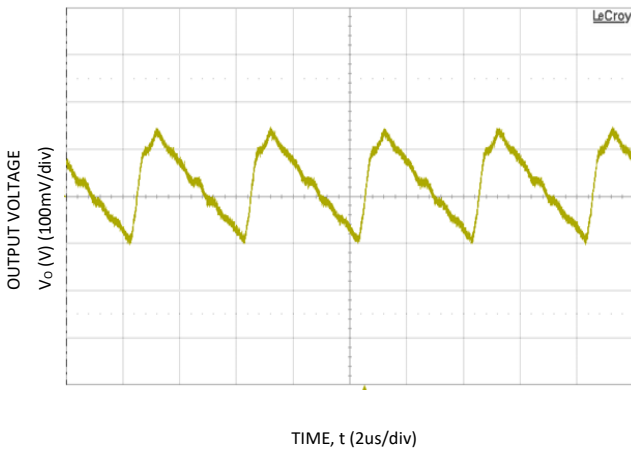

Figure 15. Typical output ripple and noise (Co=66µF ceramic, VIN = 12V, Io = Io,max.).

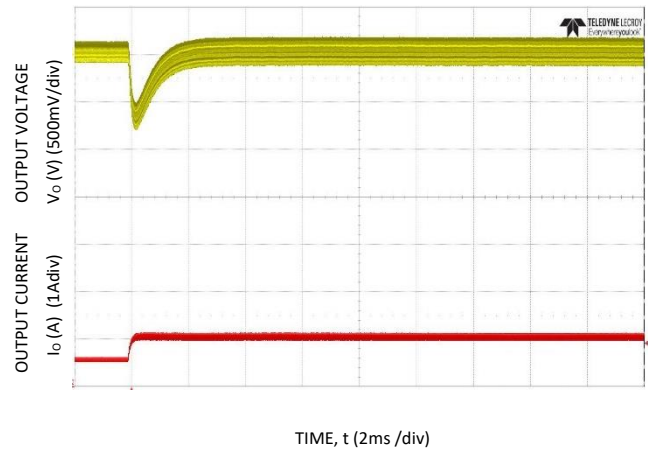

Figure 16. Transient Response to Dynamic Load Change from 0.65A to 1.15A at 12Vin, Cout=9x4.7uF, CTune=220pF, RTune=40.2kΩ

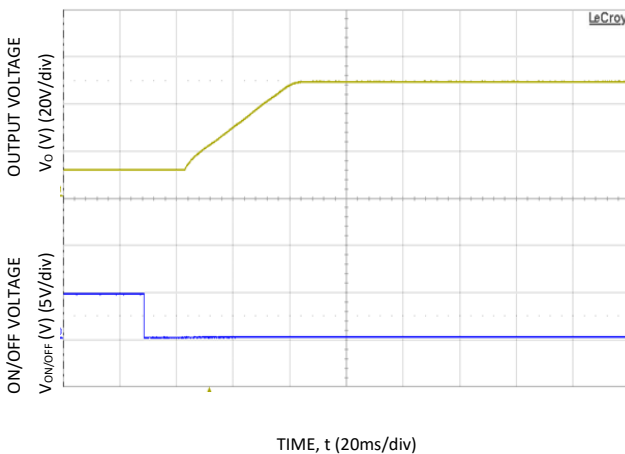

Figure 17. Typical Start-up Using On/Off Voltage (Io = Io,max.).

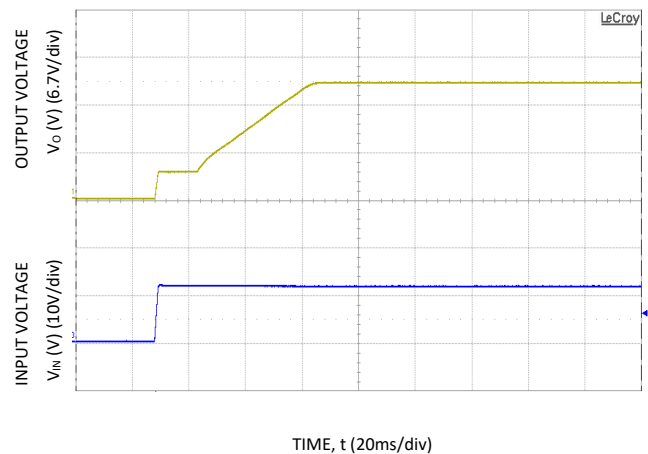

Figure 18. Typical Start-up Using Input Voltage (VIN = 12V, Io = Io,max.).

65W Boost Converter: Non-Isolated DC-DC Power Modules

8Vdc – 16Vdc input; 32Vdc – 54Vdc output, 65W output power (max.)

Characteristic Curves

The following figures provide typical characteristics for the ABXS001at 54V_o and 25°C

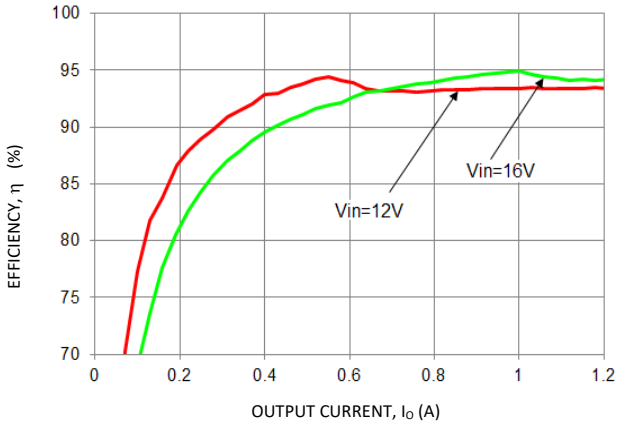

Figure 19. Converter Efficiency versus Output Current.

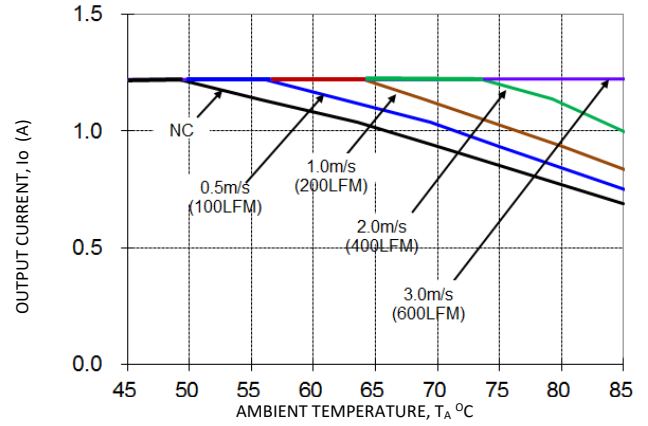

Figure 20. Derating Output Current versus Ambient Temperature and Airflow, VIN = 12V.

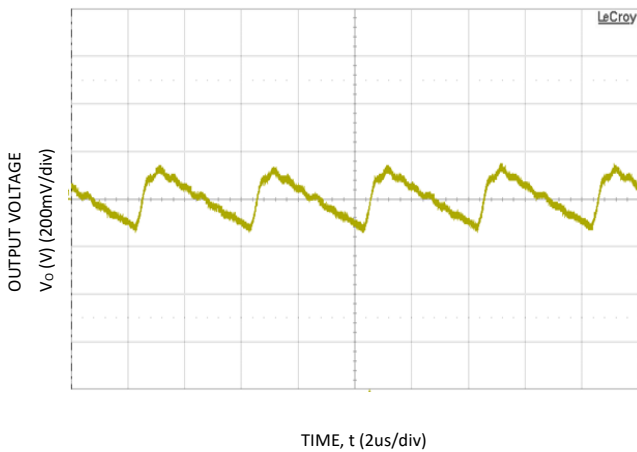

Figure 21. Typical output ripple and noise (C_o=66μF ceramic, V_{IN} = 12V, I_o = I_{o,max}).

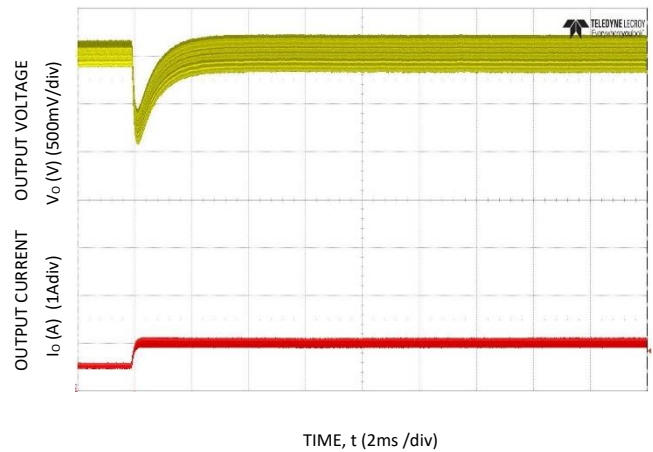

Figure 22. Transient Response to Dynamic Load Change from 0.6 to 1.1A at 12Vin, C_{out}=7x4.7uf, C_{Tune}=82pF, R_{Tune}=40.2kΩ

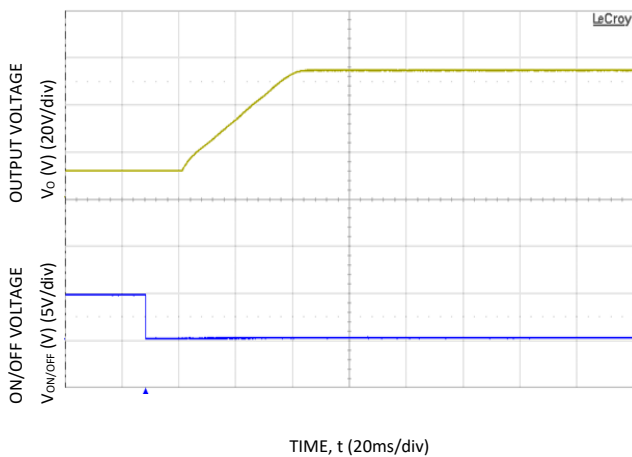

Figure 23. Typical Start-up Using On/Off Voltage (I_o = I_{o,max}).

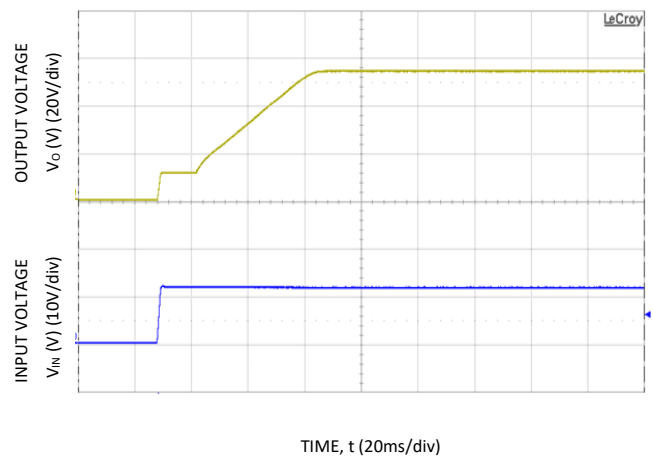

Figure 24. Typical Start-up Using Input Voltage (V_{IN} = 12V, I_o = I_{o,max}).

65W Boost Converter: Non-Isolated DC-DC Power Modules

8Vdc –16Vdc input; 32Vdc – 54Vdc output, 65W output power (max.)

Design Considerations

Input Filtering

The ABXS001Open Frame module should be connected to a low ac-impedance source. A highly inductive source can affect the stability of the module. An input capacitance must be placed directly adjacent to the input pin of the module, to minimize input ripple voltage and ensure module stability.

To minimize input voltage ripple, ceramic capacitors are recommended at the input of the module. Figure 26 shows the input ripple voltage

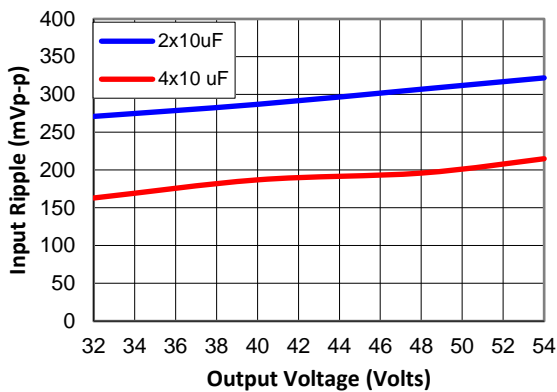

Figure 25. Input ripple voltage. Input voltage is 12V. Scope BW Limited to 20MHz

Output Filtering

These modules are designed for low output ripple voltage and will meet the maximum output ripple specification with 66uF ceramic capacitors at the output of the module. However, additional output filtering may be required by the system designer for a number of reasons. First, there may be a need to further reduce the output ripple and noise of the module. Second, the dynamic response characteristics may need to be customized to a particular load step change.

To reduce the output ripple and improve the dynamic response to a step load change, additional capacitance at the output can be used. Low ESR polymer and ceramic capacitors are recommended to improve the dynamic response of the module. Figure 27 provides output ripple information, measured with a scope with its Bandwidth limited to 20MHz for different external capacitance values at various Vo. For stable operation of the module, limit the capacitance to less than the maximum output capacitance as specified in the electrical specification table. Optimal performance of the module can be achieved by using the Tunable Loop™ feature described later in this data sheet.

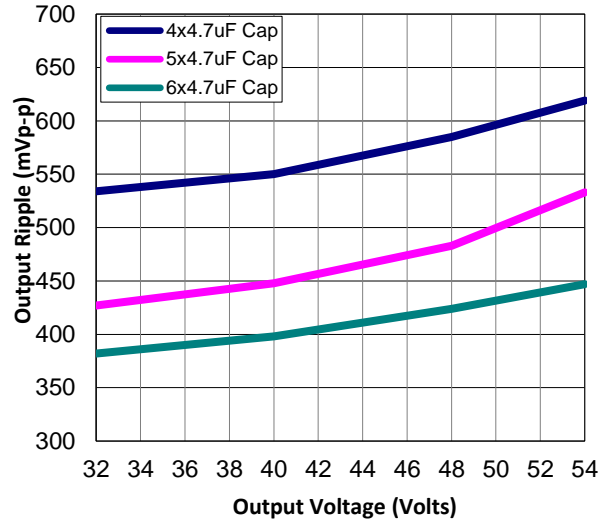

Figure 27. Output ripple voltage. Input voltage is 12V. Scope BW Limited to 20MHz

Safety Considerations

For safety agency approval the power module must be installed in compliance with the spacing and separation requirements of the end-use safety agency standards, i.e., UL ANSI/UL 62368-1 and CAN/CSA C22.2 No. 62368-1 Recognized, DIN VDE0868-1/A11:2017 (EN62368-1:2014/A11:2017).

For the converter output to be considered meeting the Requirements of safety extra-low voltage (SELV) or ES1, the input must meet SELV/ES1 requirements. The power module has extra-low voltage (ELV) outputs when all inputs are ELV.

The input to these units is to be provided with a 12A fuse in the positive input lead.

65W Boost Converter: Non-Isolated DC-DC Power Modules

8Vdc –16Vdc input; 32Vdc – 54Vdc output, 65W output power (max.)

Analog Feature Descriptions

Remote On/Off

The ABXS001 Open Frame power modules feature an On/Off pin for remote On/Off operation.

For negative logic On/Off modules, the circuit configuration is shown in Fig. 28. The On/Off pin should be pulled high with an external pull-up resistor. When Q2 turns On, the On/OFF pin is pulled low. This turns Q1 off and the internal PWM Enable is pulled high and the module turns on. When Q2 is Off, Q1 turns ON and the internal PWM Enable is pulled low and the module turns OFF

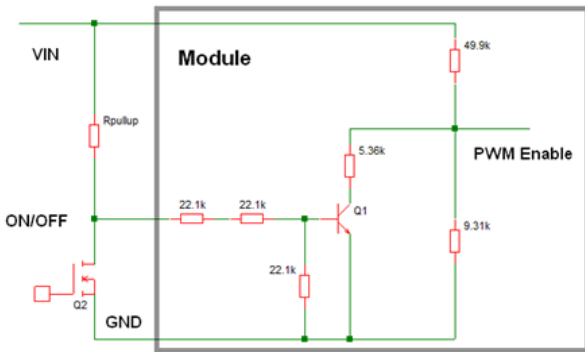

Figure 28. Circuit configuration for using negative On/Off logic.

Monotonic Start-up and Shutdown

The module has monotonic start-up and shutdown behavior for any combination of rated input voltage, output current and operating temperature range.

Startup into Pre-biased Output

The module can start into a prebiased output as long as the prebias voltage is 0.5V less than the set output voltage.

Analog Output Voltage Programming

The output voltage of each output of the module can be programmable to any voltage from 32VDC to 54VDC by connecting a resistor between the Trims and GND pins of the module.

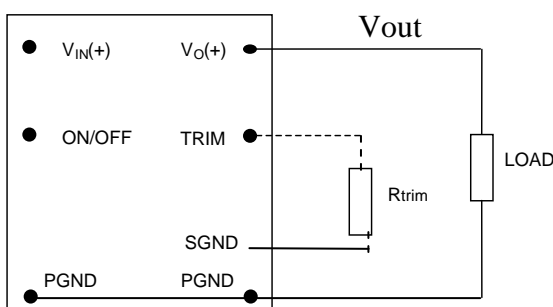

Figure29. Circuit configuration for programming output voltage using an external resistor.

Without an external resistor between TRIM and sGND pins, each output of the module will be the input voltage. The value of the trim resistor, *Rtrim* for a desired output voltage, should be as per the following equation:

$$R_{trim} = \left[\frac{1.2}{(V_o - 1.2)} \right] \times 200.5k\Omega$$

Rtrim is the external resistor in kΩ

Vo is the desired output voltage.

Table 1 provides *Rtrim* values required for some common output voltages.

Table 1

<i>V_{O, set}</i> (V)	<i>Rtrim</i> (KΩ)
32	7.812
34	7.335
36	6.914
38	6.538
40	6.201
42	5.897
44	5.621
46	5.371
48	5.141
50	4.930
52	4.736
54	4.557

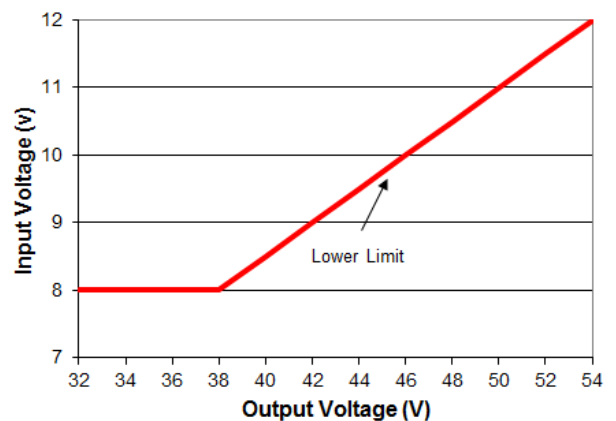

Figure 30. Output Voltage vs. Input Voltage Set Point Area plot showing limits where the output voltage can be set for different input voltages.

Analog Voltage Margining

65W Boost Converter: Non-Isolated DC-DC Power Modules

8Vdc –16Vdc input; 32Vdc – 54Vdc output, 65W output power (max.)

Output voltage margining can be implemented in the module by connecting a resistor, $R_{margin-up}$, from the Trim pin to the ground pin for margining-up the output voltage and by connecting a resistor, $R_{margin-down}$, from the Trim pin to output pin for margining-down. Figure 31 shows the circuit configuration for output voltage margining. The POL Programming Tool, available at www.gecriticalpower.com under the Downloads section, also calculates the values of $R_{margin-up}$ and $R_{margin-down}$ for a specific output voltage and % margin. Please consult your local GE Critical Power technical representative for additional details.

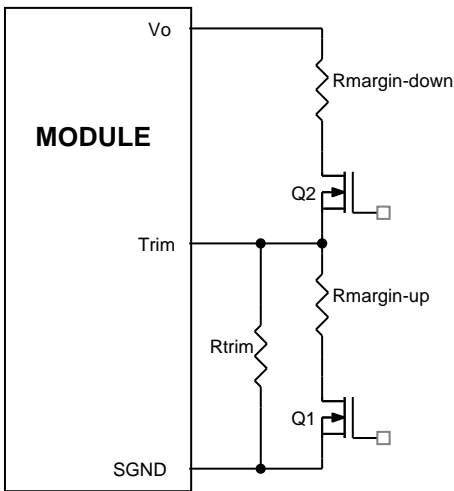

Figure 31. Circuit Configuration for margining Output voltage.

Overcurrent Protection

To provide protection in a fault (output overload) condition, the unit is equipped with internal current-limiting circuitry and can endure current limiting continuously. At the point of current-limit inception, the unit enters hiccup mode. The unit operates normally once the output current is brought back into its specified range.

Overtemperature Protection

To provide protection in a fault condition, the unit is equipped with a thermal shutdown circuit. The unit will shut down if the overtemperature threshold of 128°C (typ) is exceeded at the thermal reference point T_{ref} . Once the unit goes into thermal shutdown it will then wait to cool before attempting to restart.

Input Undervoltage Lockout

At input voltages below the input undervoltage lockout limit, the module operation is disabled. The module will begin to operate at an input voltage above the undervoltage lockout turn-on threshold.

Tunable Loop™

The module has a feature that optimizes transient response of the module called Tunable Loop™.

External capacitors are usually added to the output of the module for two reasons: to reduce output ripple and noise (see Figure 20) and to reduce output voltage deviations from the steady-state value in the presence of dynamic load current changes. Adding external capacitance however affects the voltage control loop of the module, typically causing the loop to slow down with sluggish response. Larger values of external capacitance could also cause the module to become unstable.

The Tunable Loop™ allows the user to externally adjust the voltage control loop to match the filter network connected to the output of the module. The Tunable Loop™ is implemented by connecting a series R-C between the VOUT and TRIM pins of the module, as shown in Fig. 32. This R-C allows the user to externally adjust the voltage loop feedback compensation of the module.

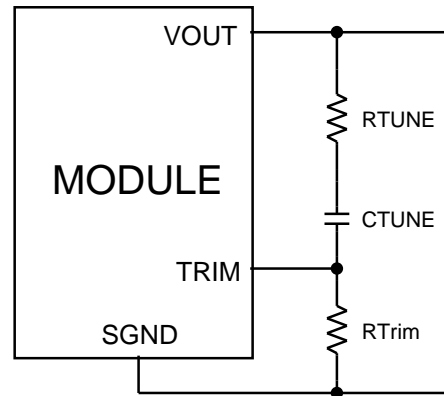

Figure 32. Circuit diagram showing connection of R_{TUNE} and C_{TUNE} to tune the control loop of the module

Recommended values of R_{TUNE} and C_{TUNE} for different output capacitor combinations are given in Table 2. Table 2 shows the recommended values of R_{TUNE} and C_{TUNE} for different values of ceramic output capacitors that might be needed for an application based on the load (for most output ripple and noise requirements the internal compensation within the module is sufficient for ceramic caps (upto 100µF)). Selecting R_{TUNE} and C_{TUNE} according to Table 2 will ensure stable operation of the module.

In applications with tight output voltage limits in the presence of dynamic current loading, additional output capacitance will be required. Table 3 lists recommended values of R_{TUNE} and C_{TUNE} in order to meet 2% output voltage deviation limits for some common output voltages for variable step changes (40-70% of full load), with an input voltage of 12V.

Please contact your GE Critical Power technical representative to obtain more details of this feature as well as for guidelines on how to select the right value of external R-C to tune the module for best transient performance and stable operation for other output capacitance values.

65W Boost Converter: Non-Isolated DC-DC Power Modules

8Vdc –16Vdc input; 32Vdc – 54Vdc output, 65W output power (max.)

Table 2. General recommended values of R_{TUNE} and C_{TUNE} for $V_{in}=12V$ and various external electrolytic capacitor combinations.

$V_o=48V$

Co	100 μ F	220 μ F	330 μ F	390 μ F
R_{TUNE}	30.1k	20.1k	20.1k	15k
C_{TUNE}	10nF	22n	33n	68n

Electrolytic Caps Esr of 100m Ω

Table 3. Recommended values of R_{TUNE} and C_{TUNE} to obtain transient deviation of 2-3% of V_{out} for varying step loads with $V_{in}=12V$

V_{in}	12V			
V_o	32V	40V	48V	54V
IStep	1to2A	0.6to1.6A	0.6to1.1A	0.6to1.1A
Co	12x4.7 μ F	10x4.7 μ F	8x4.7 μ F	7x4.7 μ F
R_{TUNE}	30.1k Ω	40.2k Ω	40.2k Ω	40.2k Ω
C_{TUNE}	820pF	560pF	120pF	82pF
ΔV	593mV	823mV	629mV	736mV

4.7 μ F, 100Vrated Ceramic Cap - GRM32DC72A475KE01 (Murata)

Power Good

The module provides a Power Good (PGOOD) signal that is implemented with an open-drain output to indicate that the output voltage is within the regulation limits of the power module. The PGOOD signal will be de-asserted to a low state if any condition such as overtemperature, overcurrent or loss of regulation occurs that would result in the output voltage going outside the specified thresholds

The PGOOD terminal can be connected through a pullup resistor (suggested value 10k Ω) to a source of 5VDC or lower

65W Boost Converter: Non-Isolated DC-DC Power Modules

8Vdc –16Vdc input; 32Vdc – 54Vdc output, 65W output power (max.)

Thermal Considerations

Power modules operate in a variety of thermal environments; however, sufficient cooling should always be provided to help ensure reliable operation.

Considerations include ambient temperature, airflow, module power dissipation, and the need for increased reliability. A reduction in the operating temperature of the module will result in an increase in reliability. The thermal data presented here is based on physical measurements taken in a wind tunnel. The test set-up is shown in Figure 33. The preferred airflow direction for the module is in Figure 34.

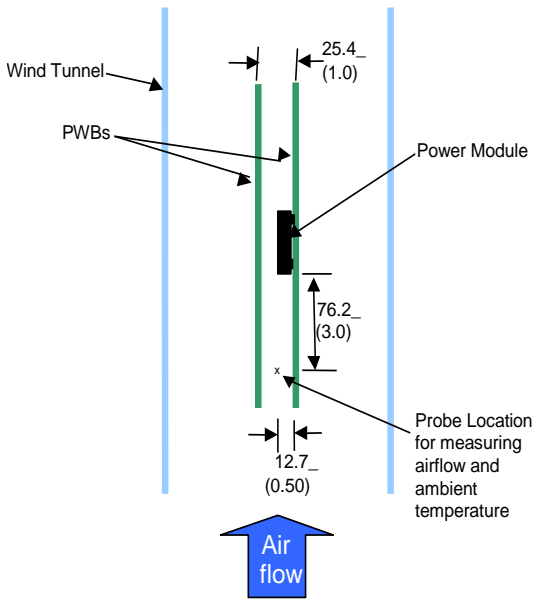

Figure 33. Thermal Test Setup.

The thermal reference points, T_{ref} used in the specifications are also shown in Figure 34. For reliable operation the temperatures at Q1 should not exceed 120°C for open-frame applications and 115°C for coldwall applications. The output power of the module should not exceed the rated power of the module ($V_{o,set} \times I_{o,max}$).

Please refer to the Application Note “Thermal Characterization Process For Open-Frame Board-Mounted Power Modules” for a detailed discussion of thermal aspects including maximum device temperatures.

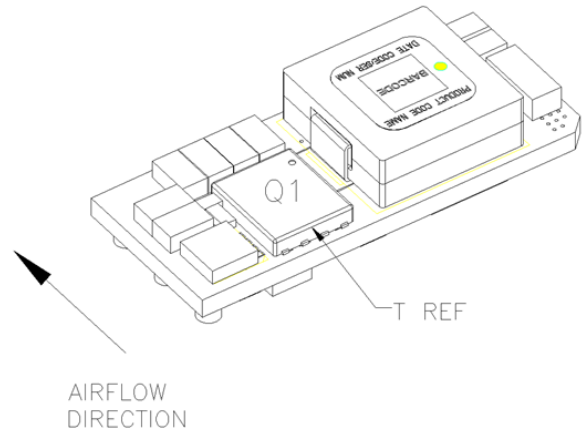

Figure 34. Preferred airflow direction and location of hot-spot of the module (T_{ref}).

65W Boost Converter: Non-Isolated DC-DC Power Modules

8Vdc –16Vdc input; 32Vdc – 54Vdc output, 65W output power (max.)

Heat Transfer via Conduction

The module can also be used in a sealed environment with cooling via conduction from the module’s top surface through a gap pad material to a cold wall, as shown below. The output current derating versus cold wall temperature, when using a thermal pad and a gap filler is shown in Figure 25.

Thermal pad: Bergquist P/N: GP2500S20
 Gap filler: Bergquist P/N: GF2000

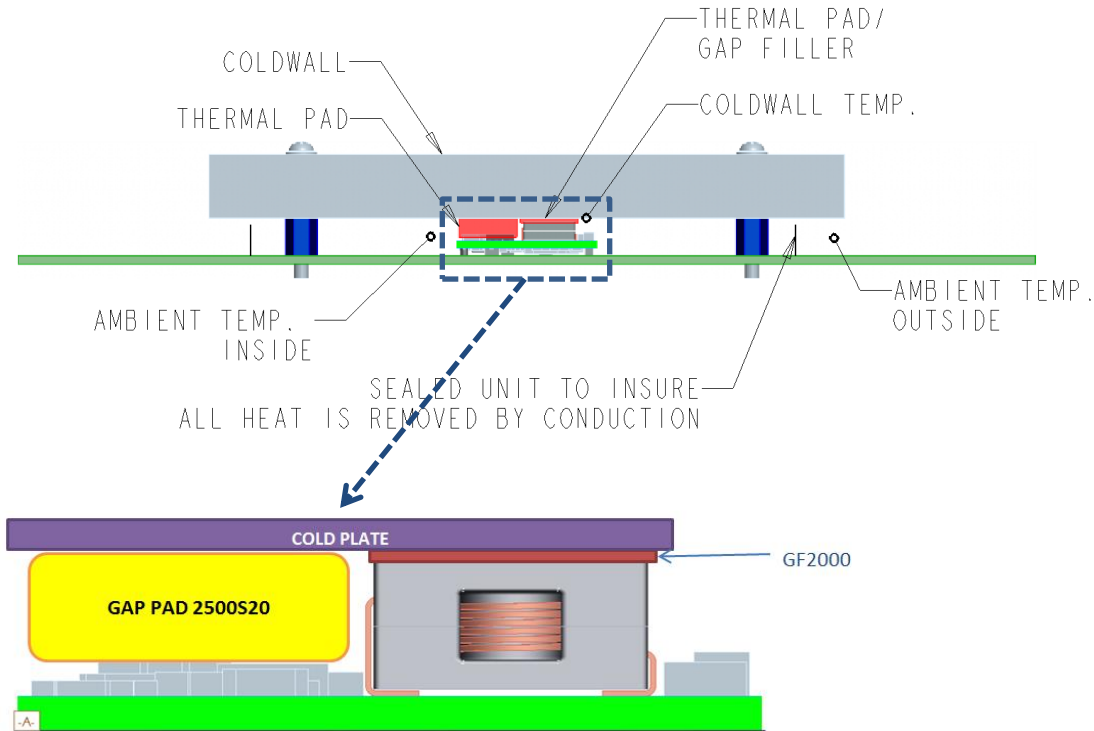
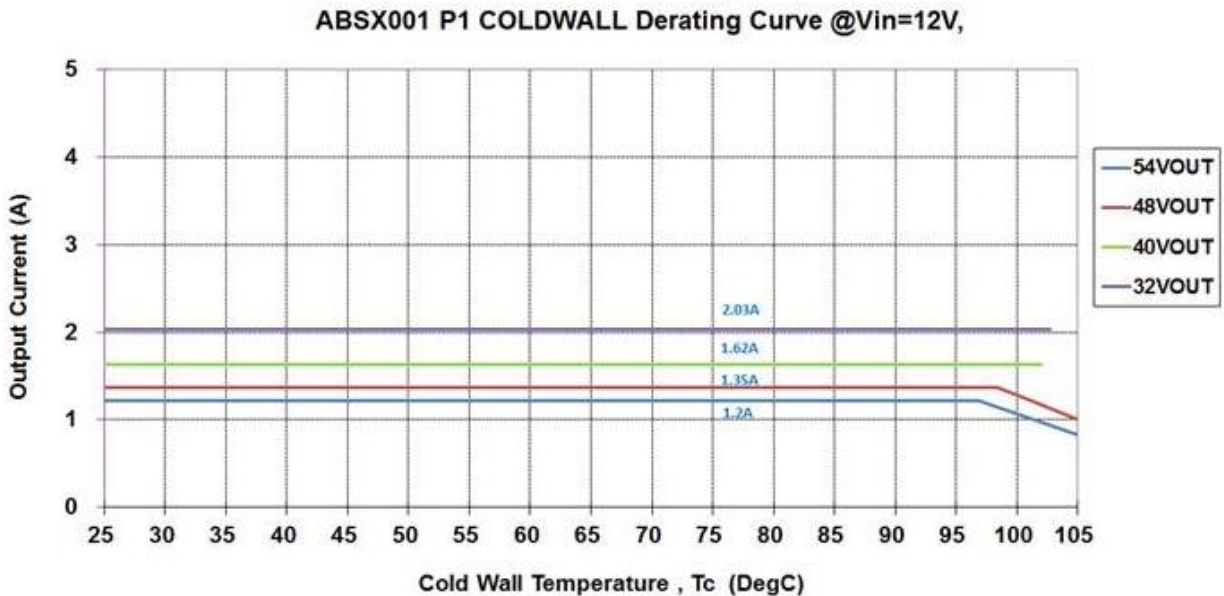

Figure 25. Output Current versus Cold Wall Temperature; $V_{IN} = 12V$.



65W Boost Converter: Non-Isolated DC-DC Power Modules

8Vdc –16Vdc input; 32Vdc – 54Vdc output, 65W output power (max.)

Example Application Circuit

Requirements:

- Vin:** 12V
- Vout:** 48V
- Iout:** 1.0A max., worst case load transient is from 0.68A to1.0A
- ΔVout:** 1.5% of Vout (720mV) for worst case load transient
- Vin, ripple** 1.5% of Vin (180mV, p-p)

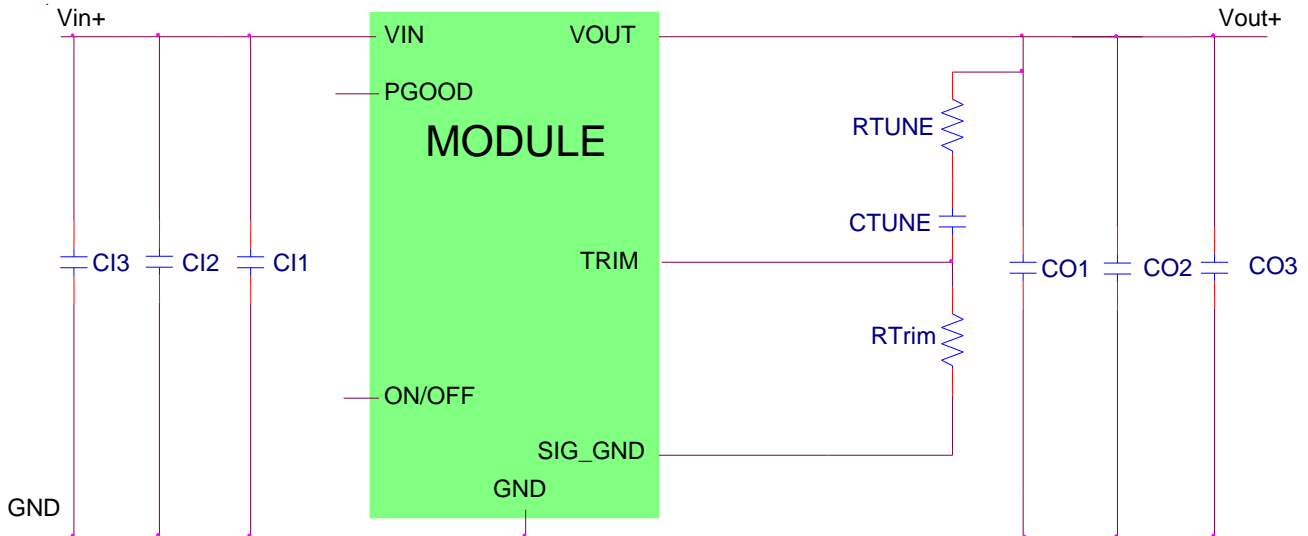

C11	1 x 0.047μF/50V, 0603 ceramic capacitor
C12	4 x 10μF/50V, 1210 ceramic capacitor
C13	1 x 220uF/25V, bulk electrolytic
CO1	1 x 0.01μF/100V, 0805 ceramic capacitor
CO2	9 x 4.7μF/100V, 1210 ceramic capacitor
CO3	1 x 220μF/100V, bulk electrolytic
CTune	220pF ceramic capacitor (can be 1206, 0805 or 0603 size)
RTune	40.2 kΩSMT resistor (can be 1206, 0805 or 0603 size)
RTrim	5.128kΩ SMT resistor (can be 1206, 0805 or 0603 size, recommended tolerance of 0.1%)

65W Boost Converter: Non-Isolated DC-DC Power Modules

8Vdc –16Vdc input; 32Vdc – 54Vdc output, 65W output power (max.)

Mechanical Outline

Dimensions are in millimeters and (inches).

Tolerances: x.x mm ± 0.5 mm (x.xx in. ± 0.02 in.) [unless otherwise indicated]

x.xx mm ± 0.25 mm (x.xxx in ± 0.010 in.)

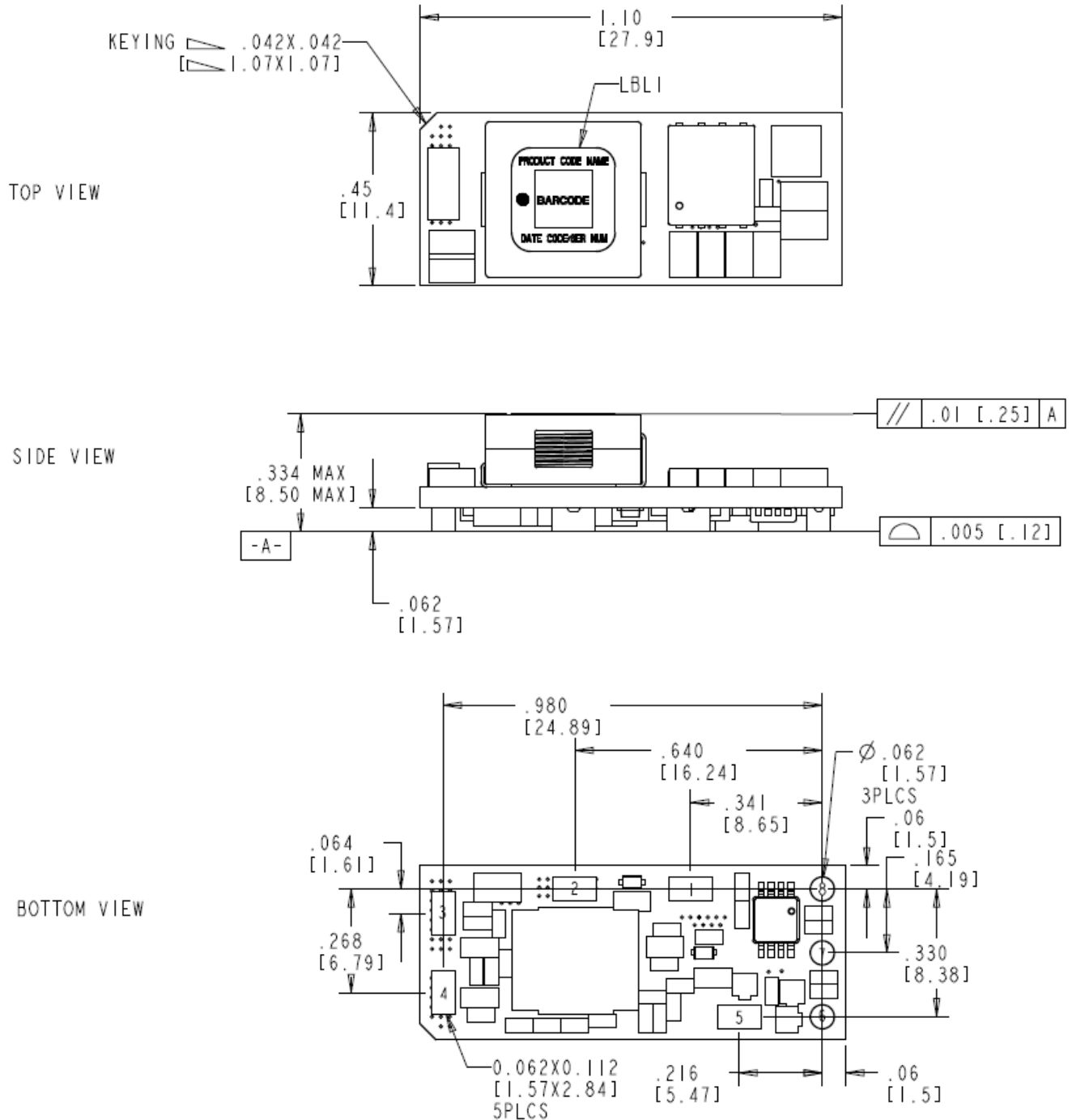

PIN	FUNCTION	PIN	FUNCTION
1	PGND	5	SGND
2	VOUT	6	TRIM
3	VIN	7	ENABLE
4	PGND	8	PGOOD

65W Boost Converter: Non-Isolated DC-DC Power Modules

8Vdc –16Vdc input; 32Vdc – 54Vdc output, 65W output power (max.)

Recommended Pad Layout

Dimensions are in millimeters and (inches).

Tolerances: $x.x \text{ mm} \pm 0.5 \text{ mm}$ ($x.xx \text{ in.} \pm 0.02 \text{ in.}$) [unless otherwise indicated]

$x.xx \text{ mm} \pm 0.25 \text{ mm}$ ($x.xxx \text{ in.} \pm 0.010 \text{ in.}$)

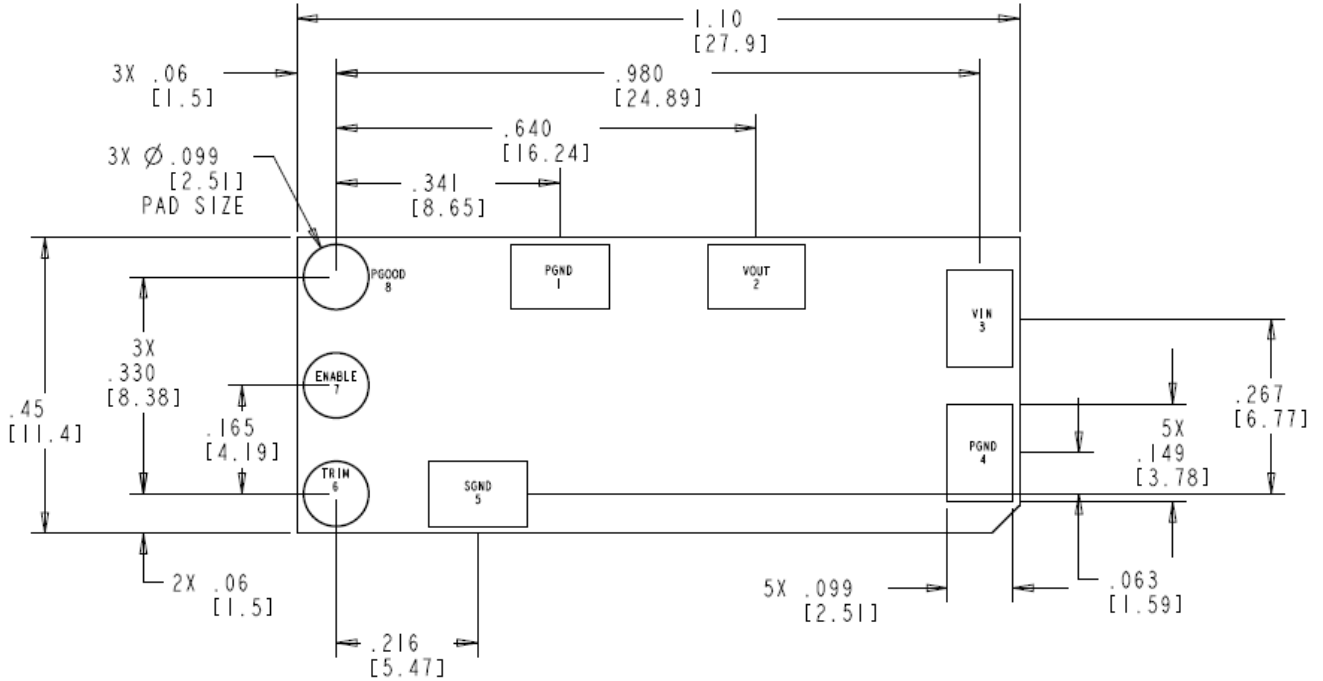

PIN	FUNCTION	PIN	FUNCTION
1	PGND	5	SGND
2	VOUT	6	TRIM
3	VIN	7	ENABLE
4	PGND	8	PGOOD

65W Boost Converter: Non-Isolated DC-DC Power Modules

8Vdc – 16Vdc input; 32Vdc – 54Vdc output, 65W output power (max.)

Packaging Details

The ABXS001 Open Frame modules are supplied in tape & reel as standard. Modules are shipped in quantities of 250 modules per reel. All Dimensions are in millimeters and (in inches).

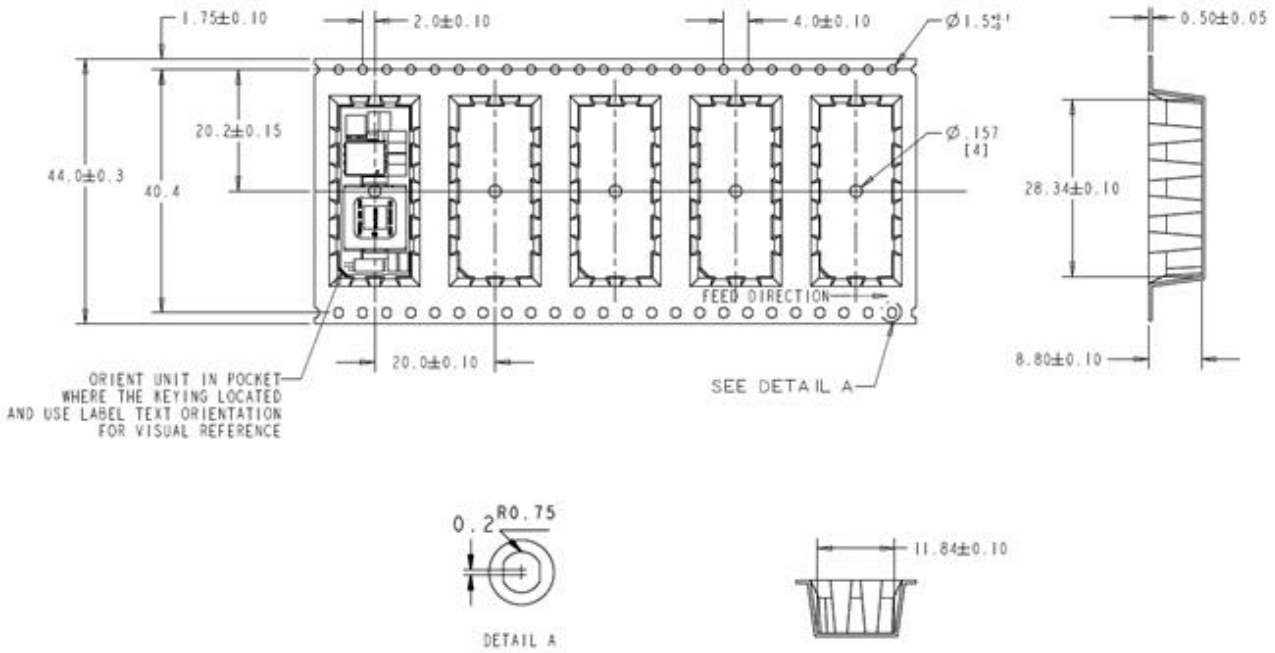
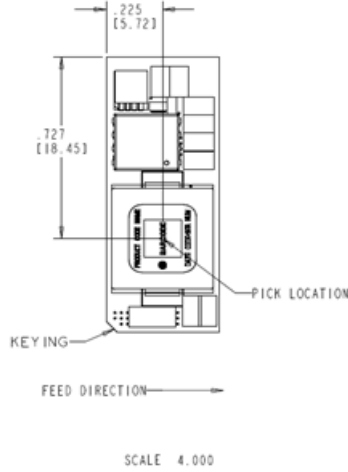

Reel Dimensions:

- Outside Dimensions: 330.2 mm (13.00")
- Inside Dimensions: 177.8 mm (7.00")
- Tape Width: 44.00 mm (1.732")

65W Boost Converter: Non-Isolated DC-DC Power Modules

8Vdc –16Vdc input; 32Vdc – 54Vdc output, 65W output power (max.)

Surface Mount Information

Pick and Place

The ABXS001 Open Frame modules use an open frame construction and are designed for a fully automated assembly process. The modules are fitted with a label designed to provide a large surface area for pick and place operations. The label meets all the requirements for surface mount processing, as well as safety standards, and is able to withstand reflow temperatures of up to 300°C. The label also carries product information such as product code, serial number and the location of manufacture.

Nozzle Recommendations

Stencil thickness of 6 mils minimum must be used for this product. The module weight has been kept to a minimum by using open frame construction. Variables such as nozzle size, tip style, vacuum pressure and placement speed should be considered to optimize this process. The minimum recommended inside nozzle diameter for reliable operation is 3mm. The maximum nozzle outer diameter, which will safely fit within the allowable component spacing, is 7 mm.

Bottom Side / First Side Assembly

This module is not recommended for assembly on the bottom side of a customer board. If such an assembly is attempted, components may fall off the module during the second reflow process.

Lead Free Soldering

The modules are lead-free (Pb-free) and RoHS compliant and fully compatible in a Pb-free soldering process. Failure to observe the instructions below may result in the failure of or cause damage to the modules and can adversely affect long-term reliability.

Pb-free Reflow Profile

Power Systems will comply with J-STD-020 Rev. D (Moisture/Reflow Sensitivity Classification for Nonhermetic Solid State Surface Mount Devices) for both Pb-free solder profiles and MSL classification procedures. This standard provides a recommended forced-air-convection reflow profile based on the volume and thickness of the package (table 4-2). The suggested Pb-free solder paste is Sn/Ag/Cu (SAC). The recommended linear reflow profile using Sn/Ag/Cu solder is shown in Fig. 35. Soldering outside of the recommended profile requires testing to verify results and performance.

MSL Rating

The ABXS001 Open Frame modules have a MSL rating of 2a

Storage and Handling

The recommended storage environment and handling procedures for moisture-sensitive surface mount packages is detailed in J-STD-033 Rev. A (Handling, Packing, Shipping and Use of Moisture/Reflow Sensitive Surface Mount Devices). Moisture barrier bags (MBB) with desiccant are required for

MSL ratings of 2 or greater. These sealed packages should not be broken until time of use. Once the original package is broken, the floor life of the product at conditions of $\leq 30^{\circ}\text{C}$ and 60% relative humidity varies according to the MSL rating (see J-STD-033A). The shelf life for dry packed SMT packages will be a minimum of 12 months from the bag seal date, when stored at the following conditions: $< 40^{\circ}\text{C}$, $< 90\%$ relative humidity.

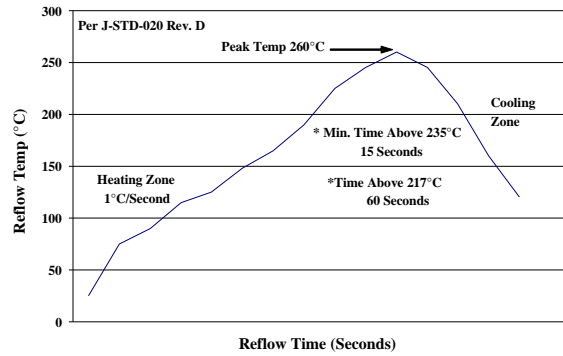

Figure 35. Recommended linear reflow profile using Sn/Ag/Cu solder.

Post Solder Cleaning and Drying Considerations

Post solder cleaning is usually the final circuit-board assembly process prior to electrical board testing. The result of inadequate cleaning and drying can affect both the reliability of a power module and the testability of the finished circuit-board assembly. For guidance on appropriate soldering, cleaning and drying procedures, refer to *Board Mounted Power Modules: Soldering and Cleaning Application Note (AN04-001)*.

65W Boost Converter: Non-Isolated DC-DC Power Modules

8Vdc –16Vdc input; 32Vdc – 54Vdc output, 65W output power (max.)

Ordering Information

Please contact your GE Sales Representative for pricing, availability and optional features.

Table 4. Device Codes

Device Code	Input Voltage Range	Output Voltage	Output Current	On/Off Logic	Comcodes
ABXS001A4X41-SRZ	8 – 16Vdc	32 – 54Vdc	1.35A (48V)	Negative	150043448

-Z refers to RoHS compliant parts

Table 5. Coding Scheme

Package Identifier	Family	Sequencing Option	Input Voltage Range	Output current	Output voltage	On/Off logic	Remote Sense	Special Code	Options	ROHS Compliance
A	B	X	S	001A4	X			41	-SR	Z
A=Non-Isolated, Non-4G	B=Boost POL	X=without sequencing	8-16Vdc	1.4A	X = programmable output	4 = positive No entry = negative	3 = Remote Sense	24/48V Output	S = Surface Mount R = Tape & Reel	Z = ROHS6

Contact Us

For more information, call us at

USA/Canada:

+1 877 546 3243, or +1 972 244 9288

Asia-Pacific:

+86-21-53899666

Europe, Middle-East and Africa:

+49.89.878067-280

Go.ABB/Industrial



GE Critical Power reserves the right to make changes to the product(s) or information contained herein without notice, and no liability is assumed as a result of their use or application. No rights under any patent accompany the sale of any such product(s) or information.

Mouser Electronics

Authorized Distributor

Click to View Pricing, Inventory, Delivery & Lifecycle Information:

[ABB:](#)

[ABXS001A4X41-SRZ](#)