

SLF10145T-151MR79-PF



Applications	Commercial Grade
Feature	Magnetic Shield Wire Wound Ferrite Core
Series Type	SLF
Status	Production
Brand	TDK



Size	
Length(L)	10.10mm ±0.30mm
Width(W)	10.10mm ±0.30mm
Thickness Height	4.50mm ±0.30mm
Recommended Land Pattern (A)	2.50mm Nom.
Recommended Land Pattern (B)	5.60mm Nom.
Recommended Land Pattern (C)	3.20mm Nom.

Electrical Characteristics	
Inductance	150µH ±20% at 1kHz
Rated Current (L Change) [Typ.]	
Rated Current (L Change) [Max.]	790mA (10% Down)
Rated Current (Temperature Rise) [Typ.]	810mA (30°C Rise)
Rated Current (Temperature Rise) [Max.]	
DC Resistance [Typ.]	350mΩ
DC Resistance [Max.]	420mΩ
Self Resonant Frequency [Min.]	
Self Resonant Frequency [Typ.]	
Q [Min.]	
Q [Typ.]	

Other	
Operating Temp. Range (Including Self-Temp. Rise)	-40 to 105°C
Soldering Method	Reflow Iron Soldering
AEC-Q200	No
Packing	Blister (Plastic)Taping [330mm Reel]
Package Quantity	500pcs
Weight	1.3g

! Images are for reference only and show exemplary products.
 ! This PDF document was created based on the data listed on the TDK Corporation website.
 ! All specifications are subject to change without notice.

SLF10145T-151MR79-PF



Characteristic Graphs(This is reference data, and does not guarantee the products characteristics.)

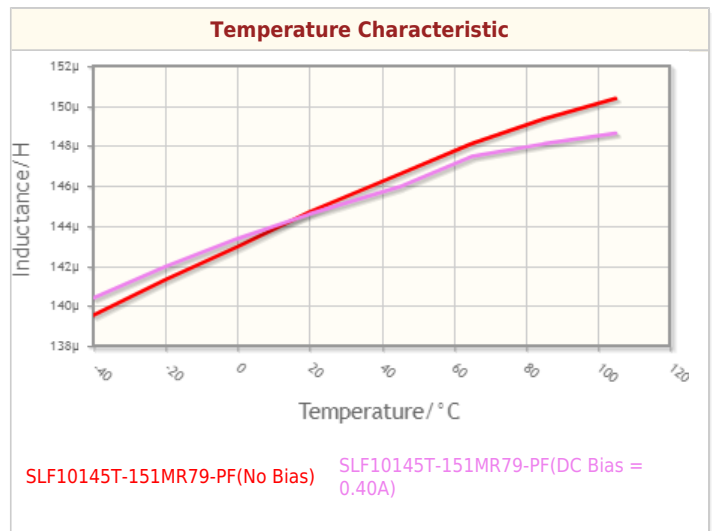
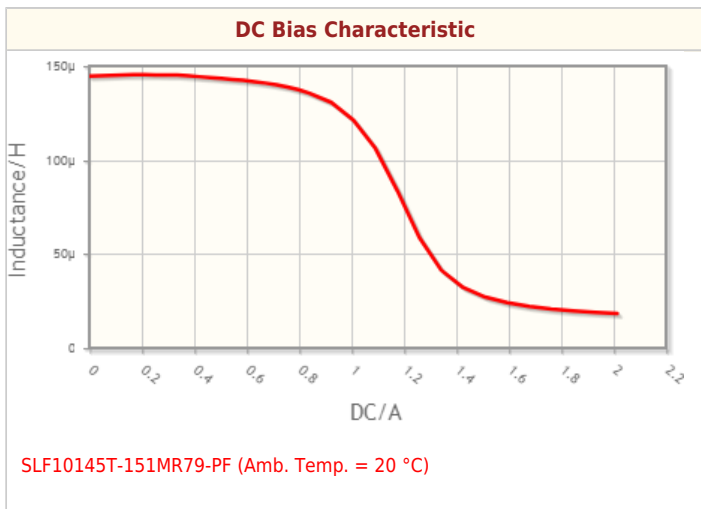
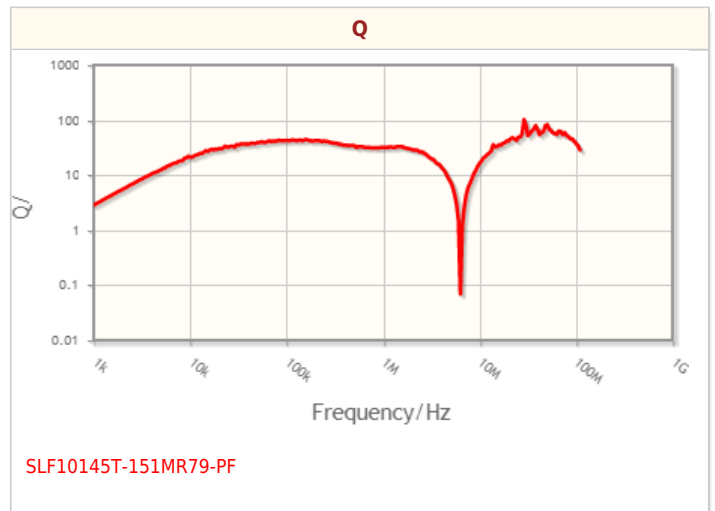
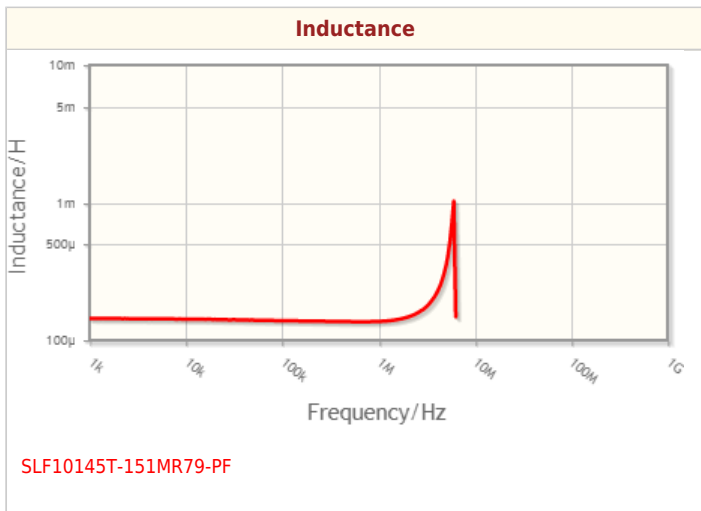
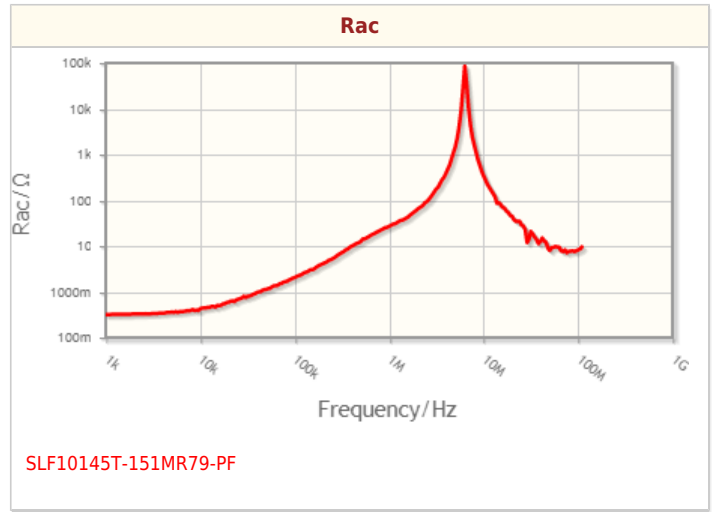
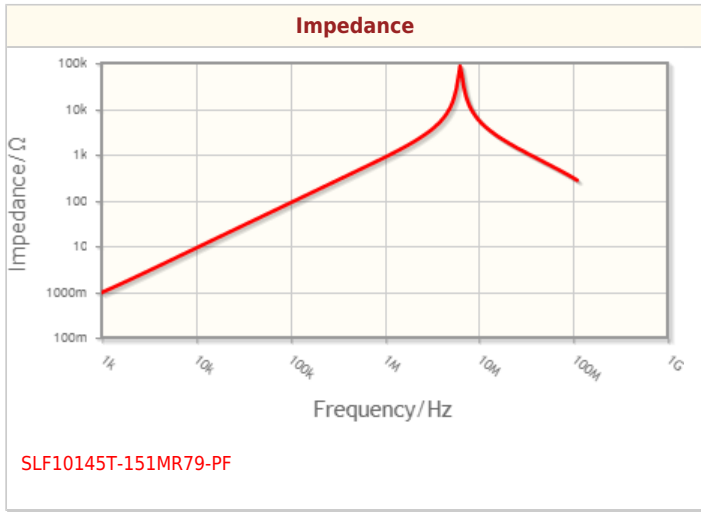

! Images are for reference only and show exemplary products.
! This PDF document was created based on the data listed on the TDK Corporation website.
! All specifications are subject to change without notice.

SLF10145T-151MR79-PF



Characteristic Graphs(This is reference data, and does not guarantee the products characteristics.)

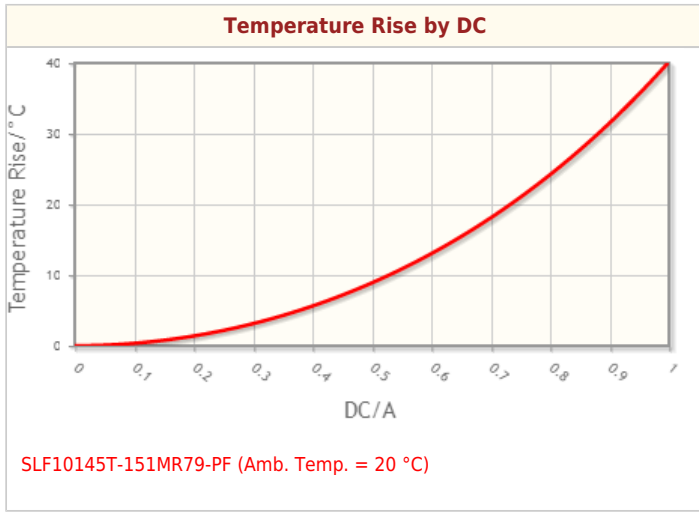

! Images are for reference only and show exemplary products.
! This PDF document was created based on the data listed on the TDK Corporation website.
! All specifications are subject to change without notice.

SLF10145T-151MR79-PF



Associated Images

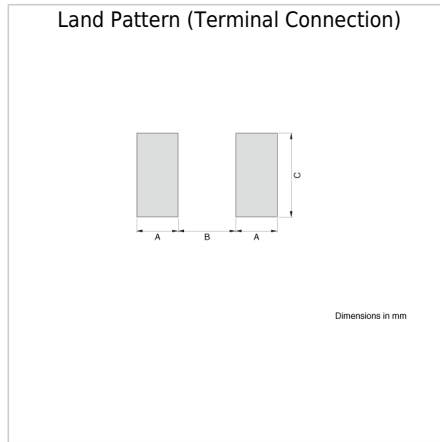
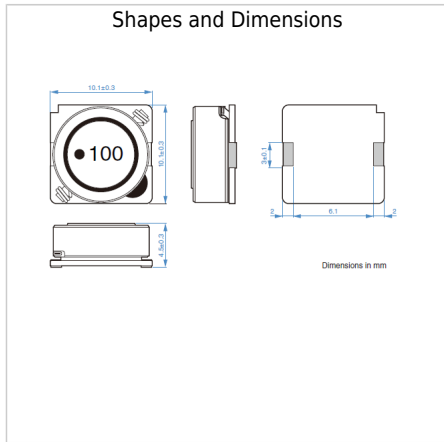

! Images are for reference only and show exemplary products.
! This PDF document was created based on the data listed on the TDK Corporation website.
! All specifications are subject to change without notice.