

Evaluation Board for the **ADE7816** Six Current Channels, One Voltage Channel Energy Metering IC

FEATURES

- Evaluation board to implement a fully functional 6-channel energy meter
- Accompanying PC-based LabVIEW software
- Easy connection of external transducers via screw terminals
- Optically isolated metering components
- USB-based PC connection
- External voltage reference option available for on-chip reference evaluation

GENERAL DESCRIPTION

The **ADE7816** evaluation kit includes an evaluation board that allows the performance of the **ADE7816** 6-channel energy measurement IC to be evaluated. The **ADE7816** evaluation kit includes evaluation software, written in LabVIEW®, that provides access to the registers of the **ADE7816** using a PC interface. This document provides information to assist the user in evaluating the **ADE7816**.

Complete specifications for the **ADE7816** are available in the **ADE7816** data sheet available from Analog Devices, Inc., and should be consulted in conjunction with this user guide when using the evaluation board.

ADE7816 INTERFACE AND EVALUATION BOARD

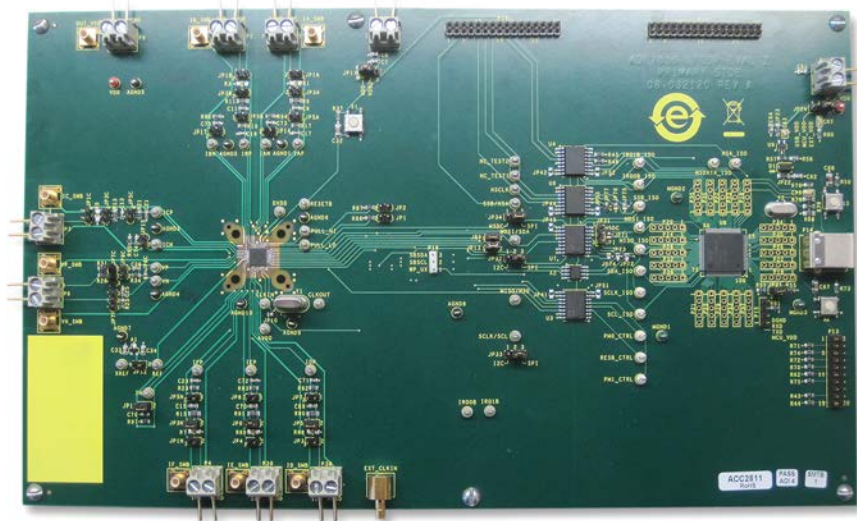

Figure 1.

TABLE OF CONTENTS

Features	1	Evaluation Software Functions	9
General Description	1	Communication	9
ADE7816 Interface and Evaluation Board	1	Main Menu	9
Revision History	2	Reset the ADE7816	9
Evaluation Board Hardware	3	Active Energy	9
Overview	3	Reactive Energy	10
Powering the ADE7816 Evaluation Board	3	RMS	10
Typical Input Configurations	3	Waveform Sampling	10
Jumper Configuration	3	ADE7816 Interrupts	11
Installing the Evaluation Board Software	7	Read and Write Registers	11
Installing the Drivers	7	All Registers Access	11
Launching the Evaluation Board Software	7	Troubleshooting	12
Running the Evaluation Software	8	Evaluation Board Schematics	13
Troubleshooting the Launch	8		

REVISION HISTORY

11/12—Rev. 0 to Rev. A

Changes to Installing the Drivers Section and to Launching the Evaluation Board Software Section	7
---	---

3/12—Revision 0: Initial Version

EVALUATION BOARD HARDWARE

OVERVIEW

The **ADE7816** evaluation kit includes an evaluation board that is used to evaluate the silicon. The board includes the **ADE7816** energy measurement IC, associated filtering, and isolation to allow high voltage inputs to be applied. It also includes an NXP Semiconductors LPC2368FBD100 microcontroller that handles all communication from the PC to the **ADE7816**. Connect P14 of the **ADE7816** evaluation board to the USB port of the PC, using the cable provided in the evaluation board kit.

A schematic of the **ADE7816** evaluation board is shown in Figure 20, Figure 21, and Figure 22

POWERING THE ADE7816 EVALUATION BOARD

An external 3.3 V dc supply is required to power up the **ADE7816** evaluation board. P9 provides the 3.3 V supply. This provides power for the **ADE7816** and the nonisolated side of the circuit, including the **ADE7816** IC. Power for the isolated side of the circuit, which includes the microcontroller, is provided by default by the USB connection. If an external power source is preferable, apply this power source on P12. When using an external power supply, Jumper JP24 must be changed to the 1, 2 position (see Table 1).

TYPICAL INPUT CONFIGURATIONS

Voltage Channel

The voltage channel input is applied to P6. The **ADE7816** evaluation board is designed to interface directly with a line voltage source. A resistor divider is therefore included to step down the input voltage. Figure 2 shows the default configuration of the voltage channel input.

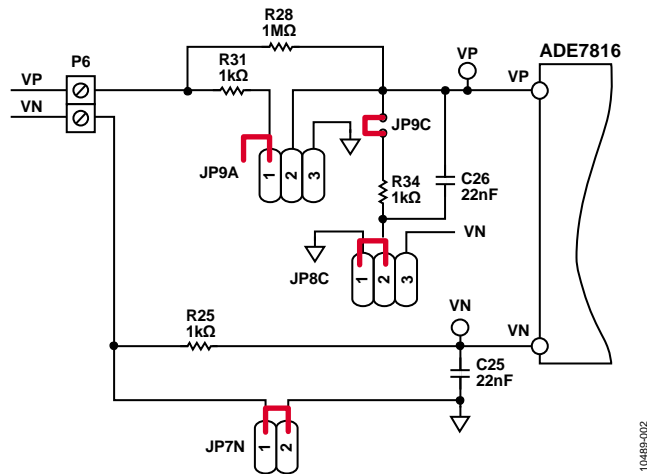

Figure 2. Typical Voltage Channel Configuration

The maximum signal level that can be applied to the VP pin of the **ADE7816** is 0.5 V peak with respect to VN. Any input level can be accommodated by modifying the resistor divider network, R28 and R34.

Current Channels

The **ADE7816** includes six single-ended current channels that can be interfaced with either a current transformer (CT) or a Rogowski coil. Apply the sensor output for Current Channel A to P1. Similar to the voltage channel, all current inputs have a maximum input of 0.5 V peak. Figure 3 shows a typical configuration for Current Channel A when a CT is being used.

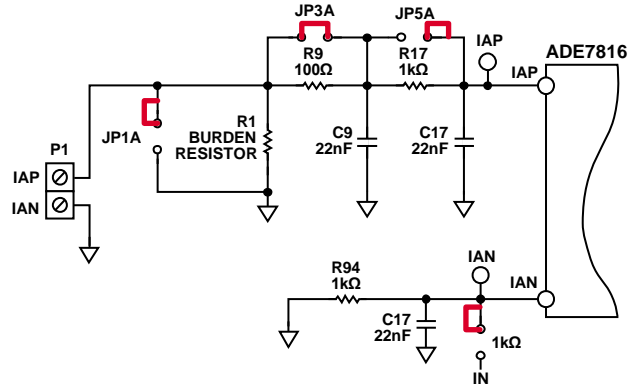

Figure 3. Typical Current Channel A Configuration with a CT

If a Rogowski coil is used, no burden resistor is required. A second stage antialiasing filter is recommended and is enabled through JP3A. Because the differential nature of the Rogowski coil output counterbalances a single-pole filter, a second stage is required to achieve a suitable level of attenuation at the Nyquist frequency.

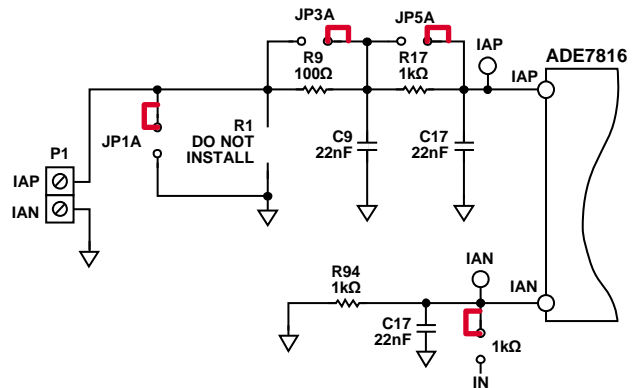

Figure 4. Typical Current Channel A Configuration with a Rogowski Coil

Current Channel B through Current Channel F are configured in a similar manner. Note, however, that Current Channel D, Current Channel E, and Current Channel F share a common neutral line and, therefore, only a single antialiasing filter is present on the neutral line for all three channels.

JUMPER CONFIGURATION

Table 1 describes the jumpers included on the **ADE7816** evaluation board and the required settings for different configurations. Before connecting any high voltage signal, review the jumper configuration and verify that it is correct for its specific setup.

Table 1. Jumper Configurations

Jumper	Option	Description
JP1	Closed	Pin 2 (PULL_HIGH) is controlled externally by the microcontroller.
	Open (default)	Pin 2 (PULL_HIGH) is connected to VDD via the pull-up resistor, R86.
JP1A	Closed	This connects Pin 1 of the Channel IA pin connector (P1) to AGND. Use this configuration in conjunction with JP3A and JP5A closed to short the IAP pin of the ADE7816 to AGND.
	Open (default)	Pin 1 of the Channel IA pin connector (P1) is left floating. Use this configuration in normal operation to drive the IAP pin with an analog signal.
JP1B	Closed	This connects Pin 1 of the Channel IB pin connector (P2) to AGND. Use this configuration in conjunction with JP3B and JP5B closed to short the IBP pin of the ADE7816 to AGND.
	Open (default)	Pin 1 of the Channel IB pin connector (P2) is left floating. Use this configuration in normal operation to drive the IBP pin with an analog signal.
JP1C	Closed	This connects Pin 1 of the Channel IC pin connector (P3) to AGND. Use this configuration in conjunction with JP3C and JP5C closed to short the ICP pin of the ADE7816 to AGND.
	Open (default)	Pin 1 of the Channel IC pin connector (P3) is left floating. Use this configuration in normal operation to drive the ICP pin with an analog signal.
JP1N	Closed	This connects Pin 1 of the Channel IF pin connector (P4) to AGND. Use this configuration in conjunction with JP3N and JP5N closed to short the IFP pin of the ADE7816 to AGND.
	Open (default)	This connects Pin 1 of the Channel IC pin connector (P4) to AGND. Use this configuration in conjunction with JP3N and JP5N closed to short the IFP pin of the ADE7816 to AGND.
JP2	Closed	Pin 3 (PULL_LOW) is controlled externally by the microcontroller.
	Open (default)	Pin 3 (PULL_LOW) is connected to GND via the pull-down resistor, R87.
JP3	Closed	This connects Pin 1 of the Channel ID pin connector (P38) to AGND. Use this configuration in conjunction with JP5 and JP7 closed to short the IDP pin of the ADE7816 to AGND.
	Open (default)	Pin 1 of the Channel ID pin connector (P38) is left floating. Use this configuration in normal operation to drive the IDP pin with an analog signal.
JP3A	Closed (default)	This disables the antialiasing filter composed of R9 and C9 in the IAP signal path. This filter is required only when using a di/dt sensor.
	Open	This enables the antialiasing filter composed of R9 and C9 in the IAP signal path. This filter is required only when using a di/dt sensor.
JP3B	Closed (default)	This disables the antialiasing filter composed of R11 and C11 in the IBP signal path. This filter is required only when using a di/dt sensor.
	Open	This enables the antialiasing filter composed of R11 and C11 in the IBP signal path. This filter is required only when using a di/dt sensor.
JP3C	Closed (default)	This disables the antialiasing filter composed of R13 and C13 in the ICP signal path. This filter is required only when using a di/dt sensor.
	Open	This enables the antialiasing filter composed of R13 and C13 in the ICP signal path. This filter is required only when using a di/dt sensor.
JP3N	Closed (default)	This disables the antialiasing filter composed of R15 and C15 in the IFP signal path. This filter is required only when using a di/dt sensor.
	Open	This enables the antialiasing filter composed of R15 and C15 in the IFP signal path. This filter is required only when using a di/dt sensor.
JP4	Closed	This connects Pin 1 of the Channel IE pin connector (P39) to AGND. Use this configuration in conjunction with JP6 and JP8 closed to short the IEP pin of the ADE7816 to AGND.
	Open (default)	Pin 1 of the Channel IE pin connector (P39) is left floating. Use this configuration in normal operation to drive the IEP pin with an analog signal.
JP5	Closed (default)	This disables the antialiasing filter composed of R90 and C69 in the IDP signal path. This filter is required only when using a di/dt sensor.
	Open	This enables the antialiasing filter composed of R90 and C69 in the IDP signal path. This filter is required only when using a di/dt sensor.
JP5A	Closed	This disables the antialiasing filter composed of R17 and C17 in the IAP signal path.
	Open (default)	This enables the antialiasing filter composed of R17 and C17 in the IAP signal path.
JP5B	Closed	This disables the antialiasing filter composed of R19 and C19 in the IBP signal path.
	Open (default)	This enables the antialiasing filter composed of R19 and C19 in the IBP signal path.
JP5C	Closed	This disables the antialiasing filter composed of R21 and C21 in the ICP signal path.
	Open (default)	This enables the antialiasing filter composed of R21 and C21 in the ICP signal path.

Jumper	Option	Description
JP5N	Closed	This disables the antialiasing filter composed of R23 and C23 in the IFP signal path.
	Open (default)	This enables the antialiasing filter composed of R23 and C23 in the IFP signal path.
JP6	Closed (default)	This disables the antialiasing filter composed of R91 and C70 in the IEP signal path. This filter is only required when using a di/dt sensor.
	Open	This enables the antialiasing filter composed of R91 and C70 in the IEP signal path. This filter is only required when using a di/dt sensor.
JP7	Closed	This disables the antialiasing filter composed of R92 and C71 in the IDP signal path.
	Open (default)	This enables the antialiasing filter composed of R92 and C71 in the IDP signal path.
JP7C	1, 2	This bypasses the voltage divider. Use this configuration in conjunction with JP9C (open). Use this configuration when applying low voltage signals.
	2, 3	This connects the VP input to AGND.
	Open (default)	This enables the voltage divider consisting of R28 and R34. Use in conjunction with JP9C (closed). Use this configuration when applying high voltage signals.
JP7N	Closed (default)	This enables the antialiasing filter composed of R25 and C25 in the VN signal path. Connects VN to ground. Use this configuration when using high voltage signals.
	Open	This enables the antialiasing filter composed of R25 and C25 in the VN signal path.
JP8	Closed	This disables the antialiasing filter composed of R93 and C72 in the IEP signal path.
	Open (default)	This enables the antialiasing filter composed of R93 and C72 in the IEP signal path.
JP8C	1, 2 (default)	This connects R34 and C26 to AGND.
	2, 3	This connects R34 and C26 to VN. This configuration is not typically used in normal operation.
JP9	Closed	Pin 34 (NC) is connected to the microcontroller. This configuration is not required for normal operation.
	Open (default)	Pin 34 (NC) is left floating.
JP9C	Closed (default)	This enables the voltage divider consisting of R28 and R34. Use in conjunction with JP7C (open). Use this configuration when applying high voltage signals.
	Open	This bypasses the voltage divider. Use this configuration in conjunction with JP7C (1, 2). Use this configuration when applying low voltage signals.
JP10	1, 2 (default)	This connects the 16.38 MHz, on-board crystal (Y1) to the CLKIN and CLKOUT pins of the ADE7816 .
	2, 3	This allows an external clock to be connected to the EXT_CLKIN connector. This configuration disconnects the on-board crystal (Y1).
JP11	1, 2 (default)	This connects the supply of the second side of the isocouplers (VDD2) to VDD, the supply of the ADE7816 .
	2, 3	This connects the supply of the second side of the isocouplers (VDD2) to a 3.3 V supply provided at the P10 connector.
JP12	Closed	This connects the ADR280 voltage reference to the REF pin of the ADE7816 . Use this configuration when the ADE7816 is configured for external reference use.
	Open (default)	This disconnects the ADR280 voltage reference from the REF pin of the ADE7816 . Use this configuration in normal operation when the ADE7816 internal reference is used.
JP13	Closed	Pin 33 (NC) is connected to the microcontroller. This configuration is not required for normal operation.
	Open (default)	Pin 33 (NC) is left floating.
JP14	Closed	This connects the IAN pin to the IBN, ICN, and IN pins. This allows a single antialiasing filter to be used for all neutral inputs.
	Open (default)	The antialiasing filter for the IAN pin is provided by R94 and C73.
JP15	Closed	This connects the ICN pin to the IAN, IBN, and IN pins. This allows a single antialiasing filter to be used for all neutral inputs.
	Open (default)	The antialiasing filter for the ICN pin is provided by R95 and C74.
JP17	Closed	This connects the IBN pin to the IAN, ICN, and IN pins. This allows a single antialiasing filter to be used for all neutral inputs.
	Open (default)	The antialiasing filter for the IBN pin is provided by R96 and C75.
JP18	Closed	This connects the IN pin to the IAN, IBN, and ICN pins. This allows a single antialiasing filter to be used for all neutral inputs.
	Open (default)	The antialiasing filter for the IN pin is provided by R97 and C76.
JP21	Closed	This signals the microcontroller, NXP LPC2368, to declare all I/O pins as outputs. Use this configuration when another microcontroller manages the ADE7816 through the P17 socket.
	Open (default)	Disables the option to use another microcontroller to manage the ADE7816 through the P17 socket. Use this in normal operation to allow the microcontroller, NXP LPC2368 (U8), to manage the ADE7816 .

Jumper	Option	Description
JP24	1, 2	This selects an external 3.3 V power supply, provided at the P12 connector, to power the domain that includes the NXP LPC2368 and one side of the isocouplers. Use this configuration if using the USB provided power supply is not desired.
	2, 3 (default)	This selects the USB provided power supply to power the domain that includes the NXP LPC2368 and one side of the isocouplers. Use this in normal operation to provide the power to the NXP LPC2368 and one side of the isocouplers from the PC.
JP31, JP32, JP33, JP34	1, 2	Use this configuration to select I ² C communication between the ADE7816 and the NXP LPC2368 microcontroller. In this configuration, the HSDC port is enabled.
	2, 3 (default)	Use this configuration to select SPI communication between the ADE7816 and the NXP LPC2368 microcontroller. In this configuration, HSDC communication is not available.

INSTALLING THE EVALUATION BOARD SOFTWARE

INSTALLING THE DRIVERS

When using the [ADE7816](#) evaluation tools for the first time, a driver must be installed to allow successful communication. The driver can be found on the Analog Device website on the [ADE7816 evaluation board](#) page by downloading the **Evaluation Board Software.zip** file. The driver is available in the **Drivers** folder. There are two folders within the **Drivers** folder:

- The **Windows XP and VISTA** folder contains the driver suitable for 32-bit operating systems, such as Windows® XP and the 32-bit version of Windows Vista.
- The **Windows 7 (64 bit)** folder contains the driver suitable for 64-bit operating systems, such as Windows 7.

Select the appropriate driver based on the operating system used. To install the driver, follow this procedure. Note that the format of the screens may vary depending on the operating system being used.

1. Connect the USB cable to the PC and the interface board. The **Found New Hardware Wizard** window appears, indicating that the PC has detected the new hardware.

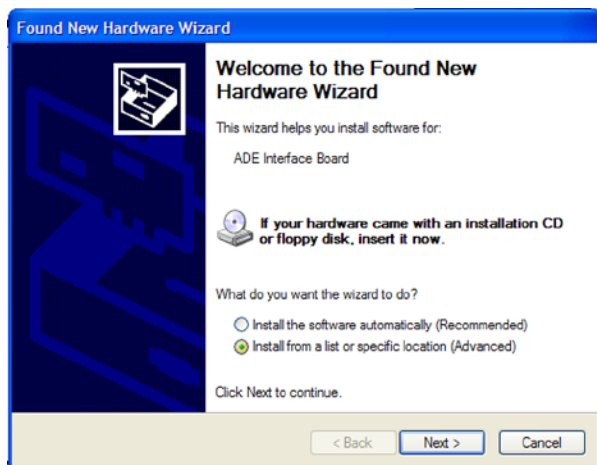

Figure 5. Found New Hardware Wizard Screen

2. If you are installing the driver on a system running Windows 7, the **Found New Hardware Wizard** may not appear. To manually select the driver, follow these steps.
 - a. Choose **Control Panel > Hardware and Sound > Device Manager** and locate the new hardware under the **Ports** heading.
 - b. Right-click the port and select **Update Driver Software**.
 - c. Select **Browse my Computer for Driver Software**. A window similar to that shown in Figure 6 appears.
 - d. Go to Step 4.

3. In the **Found New Hardware Wizard** window, select the **Install from a list or specific location (Advanced)** option and click **Next >**.

The window shown in Figure 6 appears.

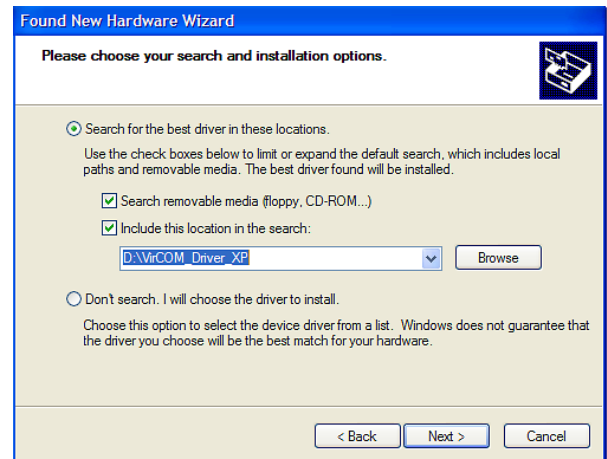

Figure 6. Search for Driver Window

4. Select **Include this location in the search:** and click the **Browse** button to locate the **Windows XP and VISTA** or **Windows 7 (64 bit)** folder in the **Drivers** folder downloaded from the Analog Devices website on the [ADE7816 evaluation board](#) page.
5. Click **Next >**. The **Hardware Installation** window appears, stating that the hardware did not pass the Windows Logo test.
6. Click **Continue** until the installation is complete.
7. Click **Finish** to close the window.

LAUNCHING THE EVALUATION BOARD SOFTWARE

The evaluation software is available in the ADE7816 Evaluation Board Software.zip file that can be downloaded from the [ADE7816 evaluation board](#) page on the Analog Device website. The software can be run even if a licensed copy of LabVIEW is not available.

If the [ADE7816](#) evaluation software is being used on the PC for the first time, an installer must be run. This installer is available in the **Installer** folder. To run the installer, double-click on the **setup.exe** file in the **Installer** folder. Follow the prompts to install the LabVIEW 2010 run-time engine. When the installation is complete, the [ADE7816](#) evaluation software opens automatically. It is also available in the **Start** menu. This shortcut can be found by selecting **Programs > ADE7816_Eval_Rev5**.

RUNNING THE EVALUATION SOFTWARE

When the evaluation software is running, it automatically detects the COM port that the **ADE7816** evaluation board is connected to. If the port detection is successful, the COM port number appears in the **Port Control** field, as shown in Figure 7 (COM4 in this example).

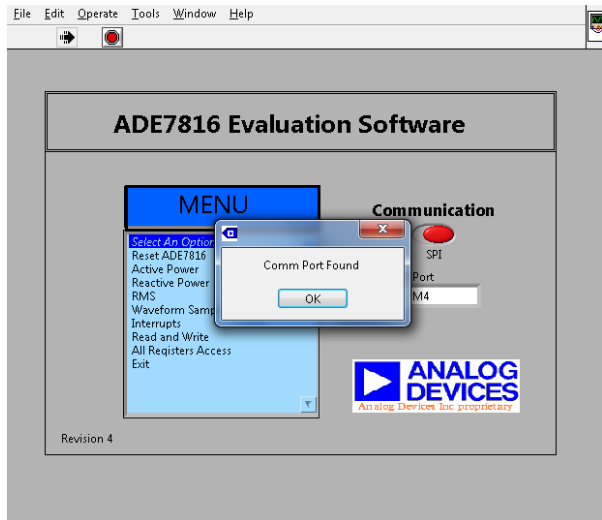

Figure 7. **ADE7816** Evaluation Software Main Window

Note that an external power supply to the evaluation board is not required for COM port detection, assuming that JP24 is set to the default position of 2, 3 (connecting Pin 2 and Pin 3 of JP24 together).

TROUBLESHOOTING THE LAUNCH

If the software does not detect the COM port, the message shown in Figure 8 displays.

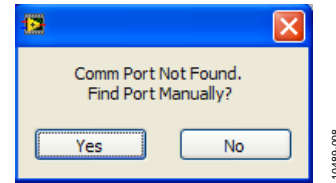

Figure 8. COM Port Not Found Message

If this message appears, take the following steps:

1. Click **Yes** to return to the **ADE7816 Evaluation Software** main window (see Figure 7).
2. Verify that the interface board is connected to the PC using the USB cable.
3. Ensure that the required drivers are installed as described in the **Installing the Drivers** section.
4. Using the **Device Manager** tool, ensure that the port is operating correctly.
5. Click the **Port Control** tab in the main window and manually select the correct COM port.

If the COM port is still not visible, close LabVIEW and reset the COM port manually. To do this, take the following steps:

1. Disconnect the USB cable connected to P14.
2. Press the S2 push-button on the **ADE7816** evaluation board.
3. Connect the USB cable to P14 again prior to relaunching LabVIEW.

EVALUATION SOFTWARE FUNCTIONS

COMMUNICATION

The ADE7816 evaluation software allows access to all registers and features of the ADE7816 using SPI, I²C, and HSDC communication. By default, the evaluation board is configured to be used with SPI. To change the mode of communication to I²C, change the JP31, JP32, JP33, and JP34 jumpers to Position 1, Position 2. Then, change the communication switch in the main window of the evaluation board software to I²C (see Figure 7). Once a menu option is selected, the communication mode locks. To change the communication after this time, the ADE7816 must be powered down by removing the power on P9.

MAIN MENU

The menu options available in the ADE7816 Evaluation Software main window include the following:

- Reset ADE7816
- Active Power
- Reactive Power
- RMS
- Waveform Sampling
- Interrupts
- Read and Write registers
- All Registers Access
- Exit (stops LabVIEW)

These options provide access to all internal registers and allow the evaluation of the performance of the ADE7816 (see Figure 7). To access these functions, click the desired option in the MENU panel. Click on an option under MENU to display a window where the specific function can be accessed.

Note that only one option under MENU can be open at a time; click Exit to return to the front panel before choosing another option under MENU.

RESET THE ADE7816

In the ADE7816 Evaluation Software main window, click Reset ADE7816. The Software Reset window appears, as shown in Figure 9.

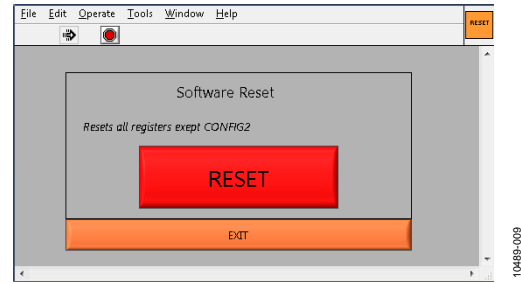

Figure 9. Reset Window

Click RESET to perform a software reset on the ADE7816. All register data is lost with the exception of the CONFIG2 register.

ACTIVE ENERGY

In the ADE7816 Evaluation Software main window, click Active Power. The Active Energy window appears, as shown in Figure 10. This window allows access to all registers associated with the active energy measurement.

The drop-down list at the top left of the window allows the channel to be selected and registers associated with Channel A through Channel F to be accessed. Click Read to read a register. Register modifications can be made directly on the signal path diagram; click Write to write these modifications to the part.

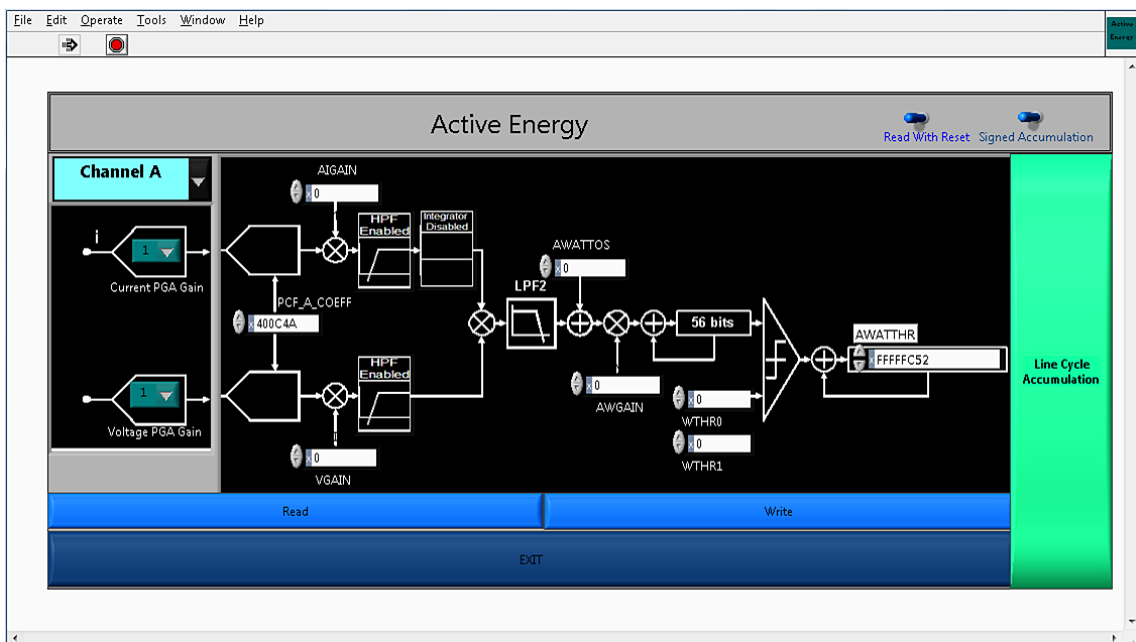

Figure 10. Active Energy Window

Within the **Active Energy** window, click **Line Cycle Accumulation** to access the window shown in Figure 11.

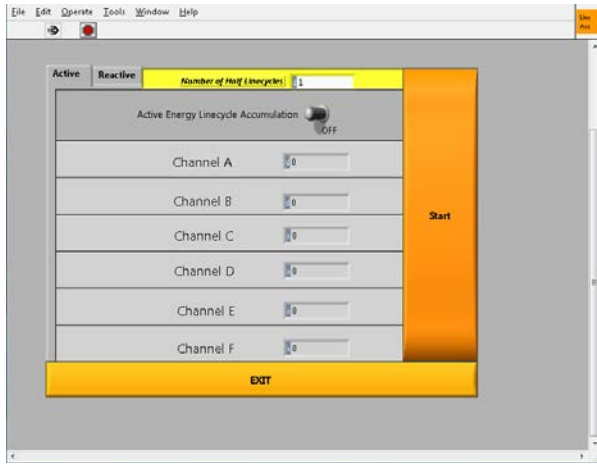

Figure 11. Line Cycle Accumulation Window

The line cycle mode allows energy to be accumulated over an integral number of half line cycles. To activate line cycle accumulation, an ac signal must be present on the voltage channel.

Click **EXIT** in the **Line Cycle Accumulation** window to return to the **Active Energy** window.

REACTIVE ENERGY

In the **ADE7816 Evaluation Software** main window, click **Reactive Power**. The **Reactive Energy** window appears. This window is similar to the **Active Energy** window shown in Figure 10; however, it allows access to registers that are associated with the reactive energy measurements. The drop-down list at the top left of the window allows the channel to be changed to access registers associated with Channel A through Channel F. The **Line Cycle Accumulation** window (see Figure 11) is also accessible from the **Reactive Energy** window.

RMS

In the **ADE7816 Evaluation Software** main window, click **RMS** to display the window shown in Figure 12. From this window, registers associated with the I_{RMS} and V_{RMS} measured are accessed. Click **Read Setup** and **Write Setup** to allow the configuration to be read and modified, respectively. Under the **Reading Time/Channel** slide bar, click **Read RMS Continuously** to read continuously over a specified time.

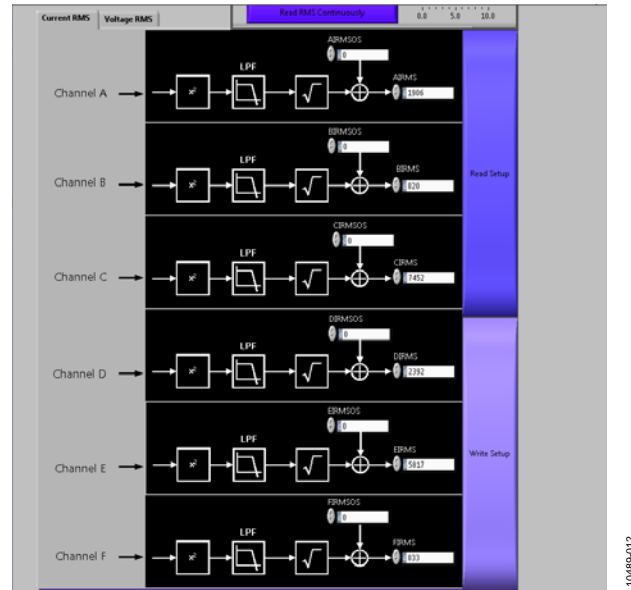

Figure 12. RMS Window

WAVEFORM SAMPLING

The **Waveform Sampling** window is shown in Figure 13. To use the **Waveform Sampling** window, I²C must be selected as the communication interface (see Figure 7) in the **ADE7816 Evaluation Software** main window. The I²C interface is used in conjunction with the HSDC interface (see the **ADE7816** data sheet).

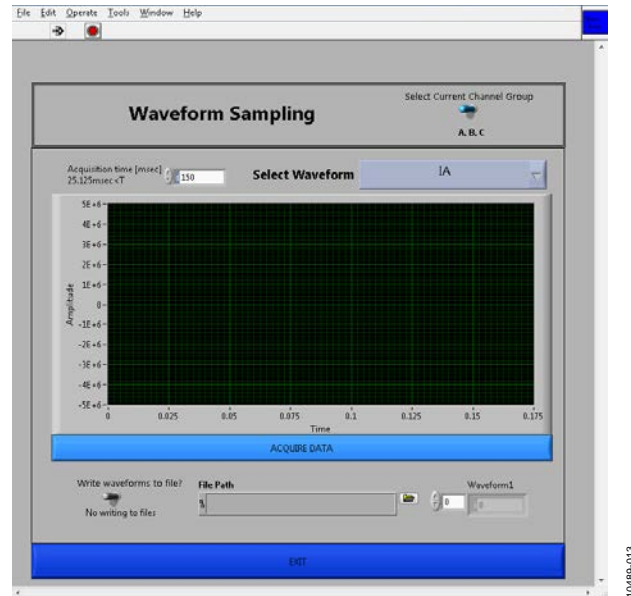

Figure 13. Waveform Sampling Window

This window allows raw waveform data to be captured and displayed on a graph. To save the data to a file, click **Write waveforms to file?** and enter a destination in the **File Path** box.

ADE7816 INTERRUPTS

The **ADE7816 Interrupts** window is shown in Figure 14.



Figure 14. ADE7816 Interrupts Window

This window allows access to the status and enable registers associated with the $\overline{IRQ0}$ and $\overline{IRQ1}$ pins. The switch buttons allow the individual interrupt enable bits to be selected. After these selections are configured, click **Write Mask0 Register** and **Write Mask1 Register** to write to the part. The lights represent the corresponding interrupt status registers. Click **Read Status0 Register** and **Read Status1 Register** to read these registers. Click **Clear Status0 Register** and **Clear Status1 Register**, respectively, to clear the $\overline{IRQ0}$ and $\overline{IRQ1}$ interrupt.

READ AND WRITE REGISTERS

The **ADE7816 Read and Write Registers** window is shown in Figure 15.

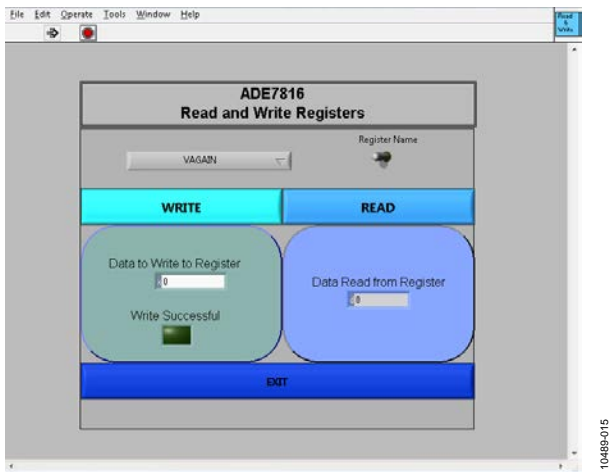

Figure 15. Read and Write Registers Window

Select the register name from the drop-down list to access an individual register from this window. Alternatively, click **Register Name** to access registers by number; clicking this button displays fields for entering a register name and register size. To access the register directly, type in the number and size of the register into the appropriate fields.

ALL REGISTERS ACCESS

The **All Registers Access** window allows all the registers in the **ADE7816** to be accessed at once (see Figure 16).

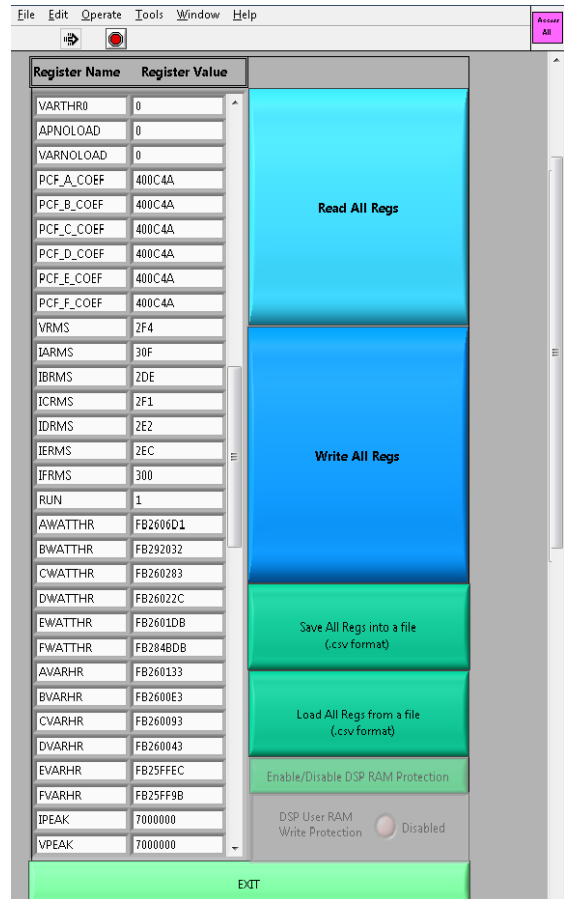

Figure 16. All Registers Access Window

Click **Read All Regs** or **Write All Regs** to read or modify the entire **ADE7816** register bank. Choose a destination file at the top of the window and click **Save All Regs into a file** to save the current configuration to a comma-separated variable (.csv) file.

To load the desired configuration from a file, click **Load All Regs from a file**; the contents of the specified .csv file are written to the **ADE7816**.

TROUBLESHOOTING

Communication Failure

If communication to the [ADE7816](#) is not successful, the warning message shown in Figure 17 displays.

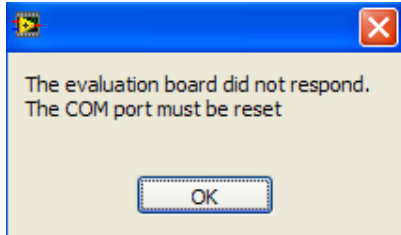

Figure 17. Communication Unsuccessful Message

This message indicates that the [ADE7816](#) did not respond and that the communication timed out. Reset the communication port on the PC to restore communication to the [ADE7816](#). Click **OK** and the **ClearPort.vi** window appears (see Figure 18).

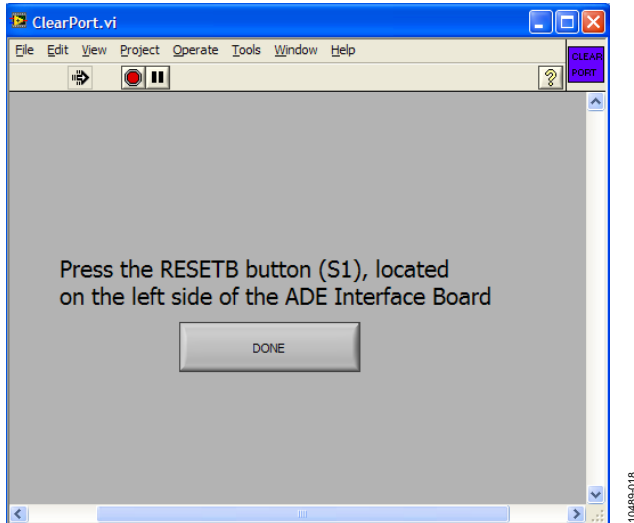

Figure 18. ClearPort.vi Window

When the **ClearPort.vi** window appears, press the S2 push-button located below the PC connection on the [ADE7816](#) interface port to reset the PC COM port (see Figure 1). After completing this action, click **DONE** in the **ClearPort.vi** window.

Before continuing with the evaluation of the [ADE7816](#), investigate the reason for the communication failure. After the COM port is cleared, the window shown in Figure 19 displays some possible reasons for the failed communication. Click **OK**.

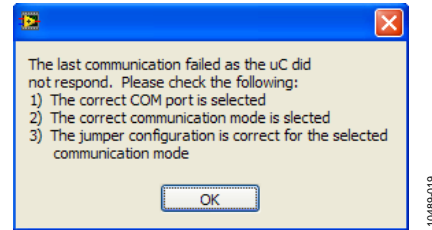

Figure 19. Error Debug Window

Next, go to the **ADE7816 Evaluation Software** main window and click **Exit** from the menu drop-down list (see Figure 7). Verify that the correct COM port is selected and ensure that the currently configured communication mode is selected in the pull-down list. Refer to Table 1 to verify that the correct jumpers are installed for the selected communication interface.

If the previous procedure does not correct the issue, take the following steps:

1. Close the evaluation software.
2. Manually reset the COM port; disconnect the USB cable connected to P14 and press the S2 push-button on the [ADE7816](#) evaluation board.
3. Connect the USB cable to P14 again, and then relaunch LabVIEW.

Incorrect Register Readings

If the data read back from the [ADE7816](#) registers is always 0xFFFF, a possible cause is that the [ADE7816](#) is not correctly powered. Ensure that a 3.3 V supply has been supplied to the [ADE7816](#), as described in the Powering the ADE7816 Evaluation Board section.

Another possible cause is that the incorrect communication port is selected. Ensure that the correct jumpers are installed and that the communication mode is selected in the **ADE7816 Evaluation Software** main window of the evaluation board, as described in the Communication section.

EVALUATION BOARD SCHEMATICS

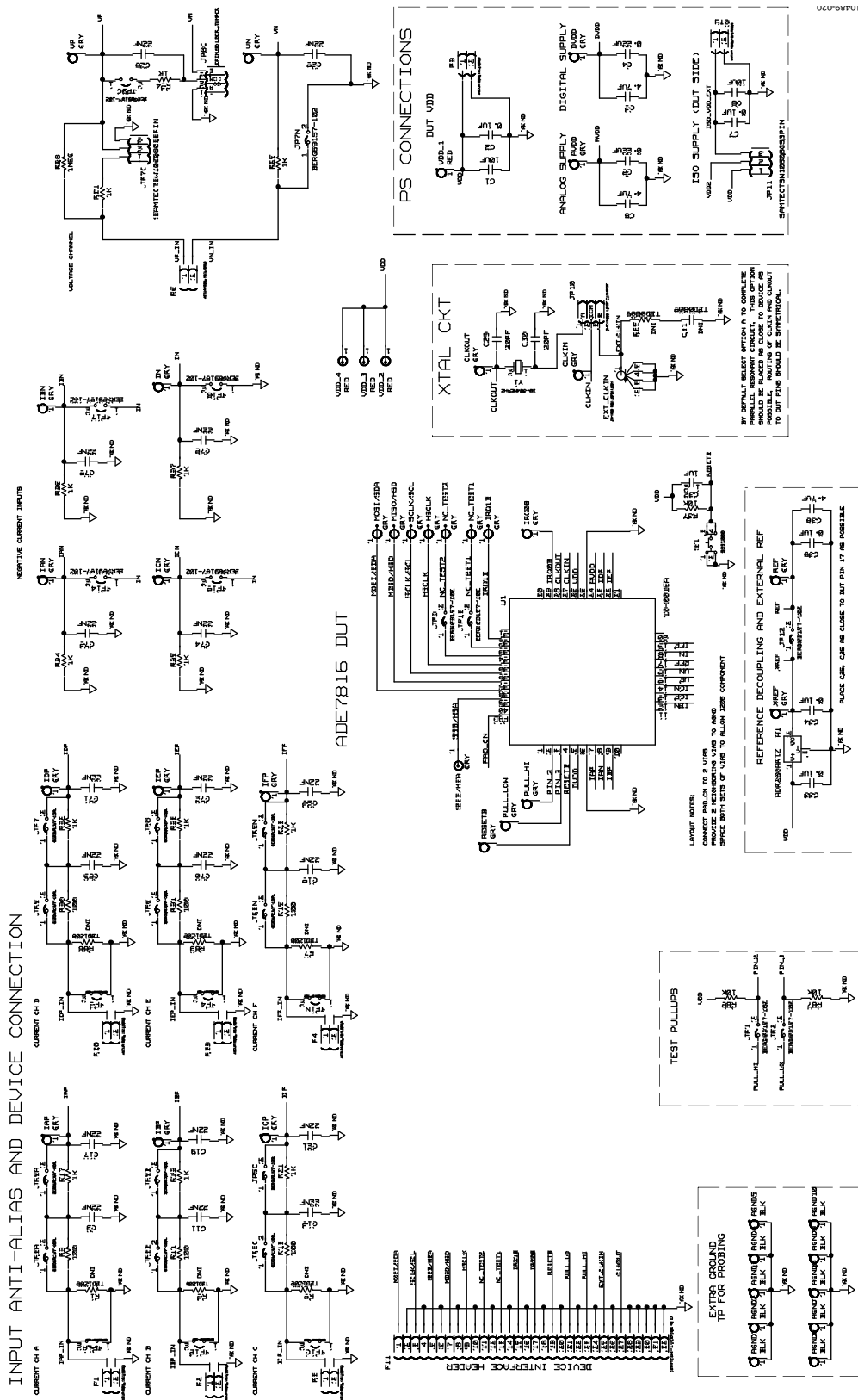

Figure 20. ADE7816 Evaluation Board Schematic (Page 1)

10489-021

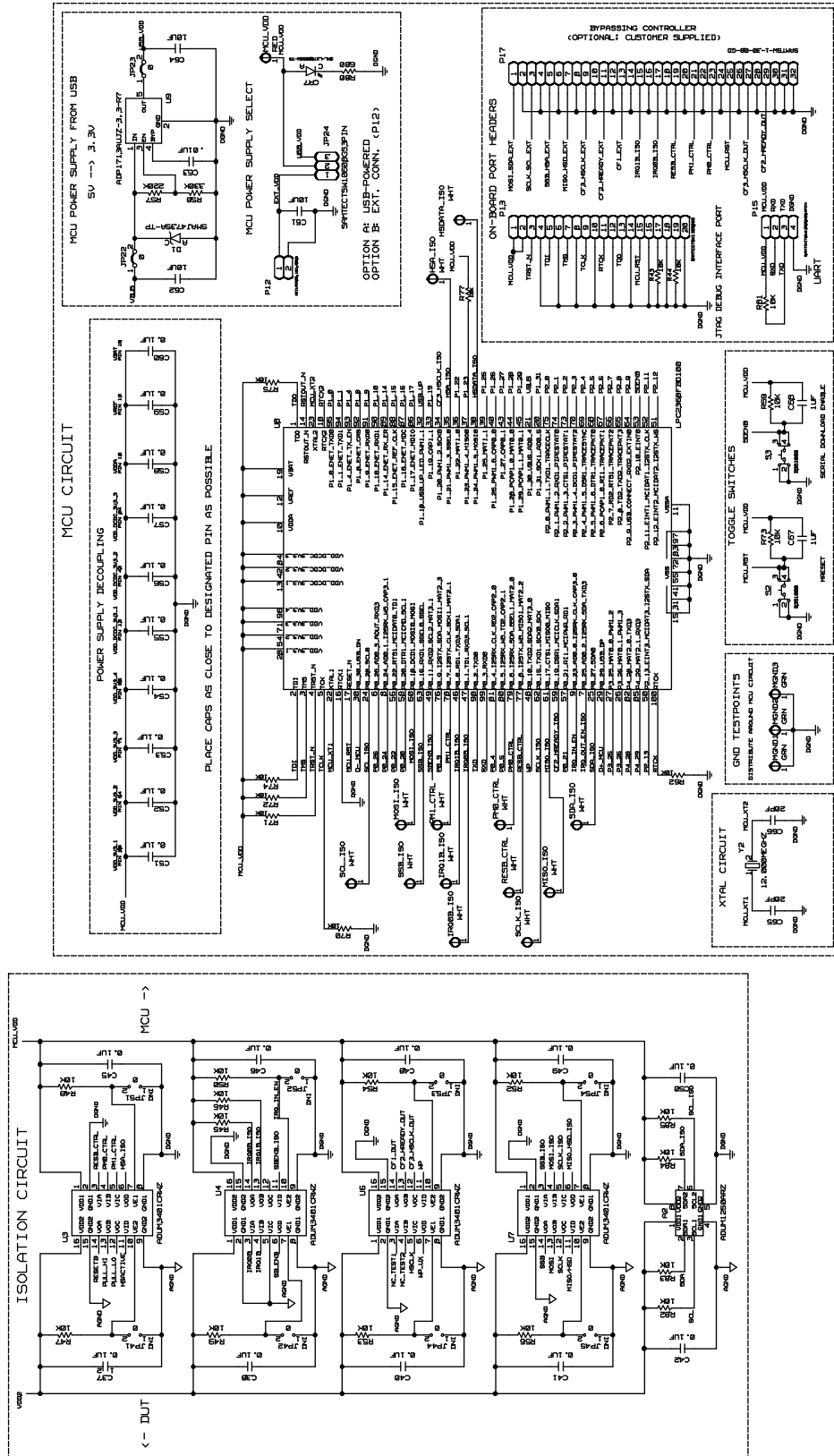

Figure 21. ADE7816 Evaluation Board Schematic (Page 2)

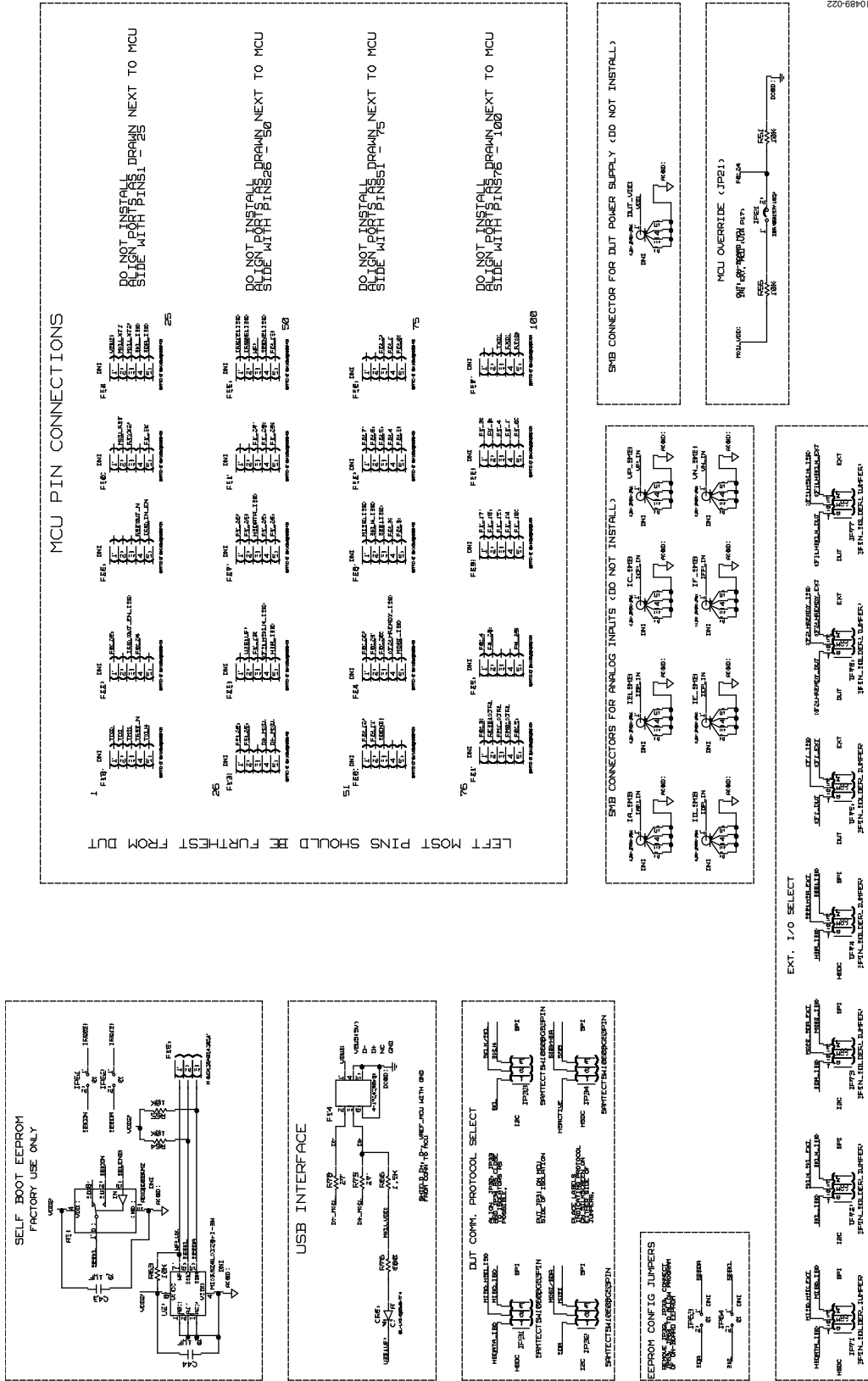

Figure 22. ADE7816 Evaluation Board Schematic (Page 3)

NOTES

**ESD Caution**

ESD (electrostatic discharge) sensitive device. Charged devices and circuit boards can discharge without detection. Although this product features patented or proprietary protection circuitry, damage may occur on devices subjected to high energy ESD. Therefore, proper ESD precautions should be taken to avoid performance degradation or loss of functionality.

Legal Terms and Conditions

By using the evaluation board discussed herein (together with any tools, components documentation or support materials, the "Evaluation Board"), you are agreeing to be bound by the terms and conditions set forth below ("Agreement") unless you have purchased the Evaluation Board, in which case the Analog Devices Standard Terms and Conditions of Sale shall govern. Do not use the Evaluation Board until you have read and agreed to the Agreement. Your use of the Evaluation Board shall signify your acceptance of the Agreement. This Agreement is made by and between you ("Customer") and Analog Devices, Inc. ("ADI"), with its principal place of business at One Technology Way, Norwood, MA 02062, USA. Subject to the terms and conditions of the Agreement, ADI hereby grants to Customer a free, limited, personal, temporary, non-exclusive, non-sublicensable, non-transferable license to use the Evaluation Board FOR EVALUATION PURPOSES ONLY. Customer understands and agrees that the Evaluation Board is provided for the sole and exclusive purpose referenced above, and agrees not to use the Evaluation Board for any other purpose. Furthermore, the license granted is expressly made subject to the following additional limitations: Customer shall not (i) rent, lease, display, sell, transfer, assign, sublicense, or distribute the Evaluation Board; and (ii) permit any Third Party to access the Evaluation Board. As used herein, the term "Third Party" includes any entity other than ADI, Customer, their employees, affiliates and in-house consultants. The Evaluation Board is NOT sold to Customer; all rights not expressly granted herein, including ownership of the Evaluation Board, are reserved by ADI. CONFIDENTIALITY. This Agreement and the Evaluation Board shall all be considered the confidential and proprietary information of ADI. Customer may not disclose or transfer any portion of the Evaluation Board to any other party for any reason. Upon discontinuation of use of the Evaluation Board or termination of this Agreement, Customer agrees to promptly return the Evaluation Board to ADI. ADDITIONAL RESTRICTIONS. Customer may not disassemble, decompile or reverse engineer chips on the Evaluation Board. Customer shall inform ADI of any occurred damages or any modifications or alterations it makes to the Evaluation Board, including but not limited to soldering or any other activity that affects the material content of the Evaluation Board. Modifications to the Evaluation Board must comply with applicable law, including but not limited to the RoHS Directive. TERMINATION. ADI may terminate this Agreement at any time upon giving written notice to Customer. Customer agrees to return to ADI the Evaluation Board at that time. LIMITATION OF LIABILITY. THE EVALUATION BOARD PROVIDED HEREUNDER IS PROVIDED "AS IS" AND ADI MAKES NO WARRANTIES OR REPRESENTATIONS OF ANY KIND WITH RESPECT TO IT. ADI SPECIFICALLY DISCLAIMS ANY REPRESENTATIONS, ENDORSEMENTS, GUARANTEES, OR WARRANTIES, EXPRESS OR IMPLIED, RELATED TO THE EVALUATION BOARD INCLUDING, BUT NOT LIMITED TO, THE IMPLIED WARRANTY OF MERCHANTABILITY, TITLE, FITNESS FOR A PARTICULAR PURPOSE OR NON-INFRINGEMENT OF INTELLECTUAL PROPERTY RIGHTS. IN NO EVENT WILL ADI AND ITS LICENSORS BE LIABLE FOR ANY INCIDENTAL, SPECIAL, INDIRECT, OR CONSEQUENTIAL DAMAGES RESULTING FROM CUSTOMER'S POSSESSION OR USE OF THE EVALUATION BOARD, INCLUDING BUT NOT LIMITED TO LOST PROFITS, DELAY COSTS, LABOR COSTS OR LOSS OF GOODWILL. ADI'S TOTAL LIABILITY FROM ANY AND ALL CAUSES SHALL BE LIMITED TO THE AMOUNT OF ONE HUNDRED US DOLLARS (\$100.00). EXPORT. Customer agrees that it will not directly or indirectly export the Evaluation Board to another country, and that it will comply with all applicable United States federal laws and regulations relating to exports. GOVERNING LAW. This Agreement shall be governed by and construed in accordance with the substantive laws of the Commonwealth of Massachusetts (excluding conflict of law rules). Any legal action regarding this Agreement will be heard in the state or federal courts having jurisdiction in Suffolk County, Massachusetts, and Customer hereby submits to the personal jurisdiction and venue of such courts. The United Nations Convention on Contracts for the International Sale of Goods shall not apply to this Agreement and is expressly disclaimed.