



## Surface Mount Multilayer Ceramic Chip Capacitors for Automotive Applications



### FEATURES

- AEC-Q200 qualified with PPAP available
- Available in 0402 to 1812 body size
- Four dielectric materials
- AgPd termination available for silver epoxy bonding
- High operating temperature
- Wet build process
- Reliable Noble Metal Electrode (NME) system
- RoHS and ELV (end-of-life vehicles) compliance, see Selection Charts
- Material categorization: for definitions of compliance please see [www.vishay.com/doc?99912](http://www.vishay.com/doc?99912)



### Note

\* This datasheet provides information about parts that are RoHS-compliant and / or parts that are non RoHS-compliant. For example, parts with lead (Pb) terminations are not RoHS-compliant. Please see the information / tables in this datasheet for details

For more than 30 years Vishay Vitramon has supported the automotive industry with robust, highly reliable MLCCs that have made it a leader in this segment. All Vishay Vitramon MLCCs are manufactured in “Precious Metal Technology” (PMT / NME) and a wet build process. They are qualified according to AEC-Q200 with PPAP available on request. Applications for these devices include automotive “under the hood”, safety and comfort electronics. Their termination finish is 100 % matte tin plate finish and AgPd which is used with silver epoxy bonding. A polymer (flexible) termination with 100 % matte tin plate finish is offered for boardflex sensitive applications.

COG (NPO) DIELECTRIC	
<b>GENERAL SPECIFICATION</b>	
<b>Note</b> Electrical characteristics at +25 °C unless otherwise specified	
<b>Operating Temperature:</b> -55 °C to +150 °C (above +125 °C changed characteristics, see 2.3)	
<b>Capacitance Range:</b> 22 pF to 22 nF	
<b>Voltage Range:</b> 25 V <sub>DC</sub> to 3000 V <sub>DC</sub>	
<b>Temperature Coefficient of Capacitance (TCC):</b> 0 ppm/°C ± 30 ppm/°C from -55 °C to +125 °C	
<b>Dissipation Factor (DF):</b> 0.1 % maximum at 1.0 V <sub>RMS</sub> and 1 MHz for values ≤ 1000 pF 0.1 % maximum at 1.0 V <sub>RMS</sub> and 1 kHz for values > 1000 pF	
<b>Insulating</b>	<b>Resistance:</b>
at +25 °C 100 000 MΩ min. or 1000 ΩF whichever is less	at +125 °C 10 000 MΩ min. or 100 ΩF whichever is less
<b>Aging:</b> 0 % maximum per decade	
<b>Dielectric Strength Test:</b> performed per method 103 of EIA 198-2-E. Applied test voltages	
≤ 250 V <sub>DC</sub> -rated:	250 % of rated voltage
500 V <sub>DC</sub> -rated:	200 % of rated voltage
630 V <sub>DC</sub> , 1000 V <sub>DC</sub> -rated:	150 % of rated voltage
3000 V <sub>DC</sub> -rated:	120 % of rated voltage

X7R, X8R DIELECTRIC	
<b>GENERAL SPECIFICATION</b>	
<b>Note</b> Electrical characteristics at +25 °C unless otherwise specified	
<b>Operating Temperature:</b> -55 °C to +150 °C (X7R above +125 °C changed characteristics, see 2.3)	
<b>Capacitance Range:</b> 120 pF to 1.0 μF	
<b>Voltage Range:</b> 16 V <sub>DC</sub> to 1000 V <sub>DC</sub>	
<b>Temperature Coefficient of Capacitance (TCC):</b> X7R: ± 15 % from -55 °C to +125 °C, with 0 V <sub>DC</sub> applied X8R: ± 15 % from -55 °C to +150 °C, with 0 V <sub>DC</sub> applied	
<b>Dissipation Factor (DF):</b> 10 V ratings: 5 % maximum at 1.0 V <sub>RMS</sub> and 1 kHz 16 V, 25 V ratings: 3.5 % maximum at 1.0 V <sub>RMS</sub> and 1 kHz > 25 V ratings: 2.5 % maximum at 1.0 V <sub>RMS</sub> and 1 kHz	
<b>Insulating Resistance:</b> at +25 °C 100 000 MΩ min. or 1000 ΩF whichever is less at +125 °C 10 000 MΩ min. or 100 ΩF whichever is less X8R: at 150 °C 10 000 MΩ min. or 100 ΩF whichever is less	
<b>Aging Rate:</b> 1 % maximum per decade	
<b>Dielectric Strength Test:</b> performed per method 103 of EIA 198-2-E. Applied test voltages	
≤ 250 V <sub>DC</sub> -rated:	250 % of rated voltage
500 V <sub>DC</sub> -rated:	min. 150 % of rated voltage
630 V <sub>DC</sub> , 1000 V <sub>DC</sub> -rated:	min. 120 % of rated voltage



QUICK REFERENCE DATA				
DIELECTRIC	CASE CODE	MAXIMUM VOLTAGE (V)	CAPACITANCE	
			MINIMUM	MAXIMUM
COG (NP0)	0402	100	22 pF	220 pF
	0603	200	56 pF	1.0 nF
	0805	500	100 pF	3.9 nF
	1206	630	100 pF	8.2 nF
	1210	630	100 pF	12 nF
	1812	3000	33 pF	22 nF
X7R	0402	100	120 pF	33 nF
	0603	200	330 pF	150 nF
	0805	500	330 pF	470 nF
	1206	630	220 pF	1.0 μF
	1210	630	390 pF	1.0 μF
	1812	630	10 nF	1.0 μF
X8R	0402	100	330 pF	6.8 nF
	0603	100	470 pF	33 nF
	0805	100	470 pF	100 nF
	1206	50	1.0 nF	220 nF
	1210	50	10 nF	330 nF

**Note**

- Detail ratings see “Selection Chart”



ORDERING INFORMATION - TIN TERMINATION								
VJ0805 <sup>(2)</sup>	Y	102	K	X	A	A	C	31
CASE CODE	DIELECTRIC	CAPACITANCE NOMINAL CODE <sup>(4)</sup>	CAPACITANCE TOLERANCE	TERMINATION	DC VOLTAGE RATING <sup>(1)</sup>	MARKING	PACKAGING	PROCESS CODE
0402 0603 0805 1206 1210 1812	A = C0G (NP0) Y = X7R H = X8R	Expressed in picofarads (pF). The first two digits are significant, the third is a multiplier. An "R" indicates a decimal point. <b>Examples</b> 4R7 = 4.7 pF 102 = 1000 pF	B = ± 0.10 pF C = ± 0.25 pF D = ± 0.5 pF F = ± 1 % G = ± 2 % J = ± 5 % K = ± 10 % M = ± 20 % <b>Note:</b> C0G (NP0): B, C, D < 10 pF F, G, J, K ≥ 10 pF X7R / X8R: J, K, M	X = Ni barrier 100 % matte tin plate finish B = polymer 100 % matte tin plate finish <sup>(3)(7)</sup>	J = 16 V X = 25 V A = 50 V B = 100 V C = 200 V P = 250 V E = 500 V L = 630 V G = 1000 V H = 3000 V	A = unmarked B = marked <b>Note:</b> marking is only available for 0805 and 1206 vendor ID and date code	E / T = 7" reel / plastic tape <sup>(5)</sup> C = 7" reel / paper tape M / R = 11 1/4" / 13" reel / plastic tape <sup>(5)</sup> P = 11 1/4" / 13" reel / paper tape	31 = automotive 100 % matte tin plate finish

ORDERING INFORMATION - SILVER PALLADIUM TERMINATION								
VJ0805 <sup>(2)</sup>	Y	102	K	F	A	A	O	34
CASE CODE	DIELECTRIC	CAPACITANCE NOMINAL CODE <sup>(4)</sup>	CAPACITANCE TOLERANCE	TERMINATION	DC VOLTAGE RATING <sup>(1)</sup>	MARKING	PACKAGING	PROCESS CODE
0402 0603 0805 1206 1210 1812	A = C0G (NP0) Y = X7R H = X8R	Expressed in picofarads (pF). The first two digits are significant, the third is a multiplier. An "R" indicates a decimal point. <b>Examples</b> 102 = 1000 pF	B = ± 0.10 pF C = ± 0.25 pF D = ± 0.5 pF F = ± 1 % G = ± 2 % J = ± 5 % K = ± 10 % M = ± 20 % <b>Note:</b> C0G (NP0): B, C, D < 10 pF F, G, J, K ≥ 10 pF X7R / X8R: J, K, M	F, E = AgPd <sup>(6)(7)</sup>	J = 16 V X = 25 V A = 50 V B = 100 V C = 200 V P = 250 V E = 500 V L = 630 V G = 1000 V H = 3000 V	A = unmarked <b>Note:</b> marking is not available	E / T = 7" reel / plastic tape <sup>(5)</sup> O = 7" reel / flamed paper tape M / R = 11 1/4" / 13" reel / plastic tape <sup>(5)</sup> I = 11 1/4" / 13" reel / flamed paper tape <b>Note:</b> "I" and "O" are used for "F", "E" termination size 0402 / 0603 / 0805	34 = automotive AgPd finish

**Notes**

- (1) DC voltage rating should not be exceeded in application. Other application factors may affect the MLCC performance. Consult for questions: [mlcc@vishay.com](mailto:mlcc@vishay.com)
- (2) Case size designator may be replaced by a four digit drawing number
- (3) Polymer termination for size 0603 and larger, contact [mlcc@vishay.com](mailto:mlcc@vishay.com) for availability of ratings. Packaging only plastic tape "E" / "M" and size 1812 "T" / "R"
- (4) Non-standard values please contact: [mlcc@vishay.com](mailto:mlcc@vishay.com) for availability
- (5) Packaging "T" and "R" is used for 1812 size
- (6) Termination code "E" / "F" is for conductive epoxy assembly
- (7) Termination code "B" and "F" are not available with X8R in 0402, 0603 - 100 V, 0805 - 100 V



**DIMENSIONS** in inches (millimeters)

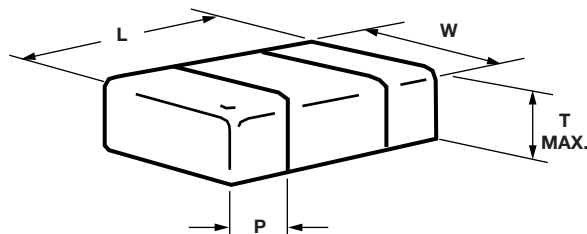

CASE CODE	STYLE	LENGTH (L)	WIDTH (W)	MAXIMUM THICKNESS (T)	TERMINATIONS PAD (P)	
					MINIMUM	MAXIMUM
0402	VJ0402	0.040 + 0.004 / - 0.002 (1.00 + 0.10 / - 0.05)	0.020 + 0.004 / - 0.002 (0.50 + 0.10 / - 0.05)	0.024 (0.60)	0.004 (0.10)	0.016 (0.41)
0603	VJ0603	0.063 ± 0.006 (1.60 ± 0.15)	0.031 ± 0.006 (0.80 ± 0.15)	0.038 (0.97)	0.012 (0.30)	0.018 (0.46)
0805	VJ0805	0.079 ± 0.008 (2.00 ± 0.20)	0.049 ± 0.008 (1.25 ± 0.20)	0.057 (1.45)	0.010 (0.25)	0.028 (0.71)
1206	VJ1206	0.126 ± 0.010 (3.20 ± 0.25)	0.063 ± 0.010 (1.60 ± 0.25)	0.067 (1.70)	0.010 (0.25)	0.028 (0.71)
1210	VJ1210	0.126 ± 0.010 (3.20 ± 0.25)	0.098 ± 0.010 (2.50 ± 0.25)	0.076 (1.94)	0.010 (0.25)	0.028 (0.71)
1812	VJ1812	0.177 ± 0.010 (4.50 ± 0.25)	0.126 ± 0.010 (3.20 ± 0.25)	0.086 (2.18)	0.010 (0.25)	0.030 (0.76)

**Note**

- Polymer (B-termination) have increased dimensions: part length increased by 0.006" (0.15 mm)



SELECTION CHART										
DIELECTRIC		COG (NP0)								
STYLE		VJ0402		VJ0603			VJ0805			
CASE CODE		0402		0603			0805			
VOLTAGE (V <sub>DC</sub> )		25 / 50	100	50	100	200	50	100	200	500
VOLTAGE CODE		X / A	B	A	B	C	A	B	C	E
CAP. CODE	CAP.									
1R0	1.0 pF									
1R2	1.2 pF									
1R5	1.5 pF									
1R8	1.8 pF									
2R2	2.2 pF									
2R7	2.7 pF									
3R3	3.3 pF									
3R9	3.9 pF									
4R7	4.7 pF									
5R6	5.6 pF									
6R8	6.8 pF									
8R2	8.2 pF									
100	10 pF									
120	12 pF									
150	15 pF									
180	18 pF									
220	22 pF	++	++							
270	27 pF	++	++							
330	33 pF	++	++							
390	39 pF	++	++							
470	47 pF	++	++							
560	56 pF	++	++	++	++	++				
680	68 pF	++	++	++	++	++				
820	82 pF	++	++	++	++	++				
101	100 pF	++	++	++	++	++	++	++	++	++
121	120 pF	++	++	++	++	++	++	++	++	++
151	150 pF	++		++	++	++	++	++	++	++
181	180 pF	++		++	++	+	++	++	++	++
221	220 pF	++		++	++	+	++	++	++	+
271	270 pF			++	++	+	++	++	++	+
331	330 pF			++	++		++	++	++	+
391	390 pF			++	++		++	++	++	+
471	470 pF			++	++		++	++	+	+
561	560 pF			++			++	++	+	
681	680 pF			++			++	++	+	
821	820 pF			++			++	++	+	
102	1.0 nF			++			++	++	+	
122	1.2 nF						++	+		
152	1.5 nF						++	+		
182	1.8 nF						+	+		
222	2.2 nF						+			
272	2.7 nF						+			
332	3.3 nF						+			
392	3.9 nF						+			
472	4.7 nF									
562	5.6 nF									
682	6.8 nF									
822	8.2 nF									
103	10 nF									
123	12 nF									
153	15 nF									
183	18 nF									
223	22 nF									
273	27 nF									
333	33 nF									
393	39 nF									
473	47 nF									
563	56 nF									

Notes

- Paper tape, • Plastic tape, ++ Paper tape, + Plastic tape, see table "Product drawings (in use)"
- For soldering conditions see Vishay Soldering Recommendations [www.vishay.com/doc?45034](http://www.vishay.com/doc?45034)
- (1) Alternative product see GA...31M, GA...34G Automotive HIFREQ Series [www.vishay.com/doc?45248](http://www.vishay.com/doc?45248)
- Light Green: RoHS and ELV (end-of-life vehicles) compliant
- Light Orange: Not RoHS and ELV (end-of-life vehicles) compliant



SELECTION CHART																
DIELECTRIC		COG (NP0)														
STYLE		VJ1206					VJ1210					VJ1812				
CASE CODE		1206					1210					1812				
VOLTAGE (V <sub>DC</sub> )		50	100	200	250	500 / 630	50	100	200	500 / 630	50	100	200	500 / 630	1000	3000
VOLTAGE CODE		A	B	C	P	E / L	A	B	C	E / L	A	B	C	E / L	G	H
CAP. CODE	CAP.															
1R0	1.0 pF															
1R2	1.2 pF															
1R5	1.5 pF															
1R8	1.8 pF															
2R2	2.2 pF															
2R7	2.7 pF															
3R3	3.3 pF															
3R9	3.9 pF															
4R7	4.7 pF															
5R6	5.6 pF															
6R8	6.8 pF															
8R2	8.2 pF															
100	10 pF															
120	12 pF															
150	15 pF															
180	18 pF															
220	22 pF															
270	27 pF															
330	33 pF															
390	39 pF															
470	47 pF															
560	56 pF															
680	68 pF															
820	82 pF															
101	100 pF	+	+	+		+	+	+	+	+	•	•	•	•	•	•
121	120 pF	+	+	+		+	+	+	+	+	•	•	•	•	•	•
151	150 pF	+	+	+		+	+	+	+	+	•	•	•	•	•	•
181	180 pF	+	+	+		+	+	+	+	+	•	•	•	•	•	•
221	220 pF	+	+	+		+	+	+	+	+	•	•	•	•	•	•
271	270 pF	+	+	+		+	+	+	+	+	•	•	•	•	•	•
331	330 pF	+	+	+		+	+	+	+	+	•	•	•	•	•	•
391	390 pF	+	+	+		+	+	+	+	+	•	•	•	•	•	•
471	470 pF	+	+	+		+	+	+	+	+	•	•	•	•	•	•
561	560 pF	+	+	+		+	+	+	+	+	•	•	•	•	•	•
681	680 pF	+	+	+		+	+	+	+	+	•	•	•	•	•	•
821	820 pF	+	+	+		+	+	+	+	+	•	•	•	•	•	•
102	1.0 nF	+	+	+		+	+	+	+	+	•	•	•	•	•	•
122	1.2 nF	+	+	+		+	+	+	+	+	•	•	•	•	•	•
152	1.5 nF	+	+	+		+	+	+	+	+	•	•	•	•	•	•
182	1.8 nF	+	+	+		+	+	+	+	+	•	•	•	•	•	•
222	2.2 nF	+	+	+	+		+	+	+		•	•	•	•	•	•
272	2.7 nF	+	+	+		+	+	+	+		•	•	•	•	•	•
332	3.3 nF	+	+	+		+	+	+			•	•	•	•	•	•
392	3.9 nF	+	+				+	+	+		•	•	•	•	•	•
472	4.7 nF	+	+				+	+	+		•	•	•	•	•	•
562	5.6 nF	+	+				+	+	+		•	•	•	•	•	•
682	6.8 nF	+	+				+	+	+		•	•	•	•	•	•
822	8.2 nF	+	+				+	+	+		•	•	•	•	•	•
103	10 nF						+	+			•	•	•	•	•	•
123	12 nF						+	+			•	•	•	•	•	•
153	15 nF										•	•	•	•	•	•
183	18 nF										•	•	•	•	•	•
223	22 nF										•	•	•	•	•	•
273	27 nF															
333	33 nF															
393	39 nF															
473	47 nF															
563	56 nF															

Notes

- Paper tape, • Plastic tape, ++ Paper tape, + Plastic tape, see table "Product drawings (in use)"
- For soldering conditions see Vishay Soldering Recommendations [www.vishay.com/doc?45034](http://www.vishay.com/doc?45034)
- (1) Alternative product see GA...31M, GA...34G Automotive HIFREQ Series [www.vishay.com/doc?45248](http://www.vishay.com/doc?45248)

Light Green: RoHS and ELV (end-of-life vehicles) compliant  
 Orange: Not RoHS and ELV (end-of-life vehicles) compliant



<b>SELECTION CHART</b>																	
<b>DIELECTRIC</b>		<b>X7R</b>															
<b>STYLE</b>		<b>VJ0402</b>				<b>VJ0603</b>					<b>VJ0805</b>						
<b>CASE CODE</b>		<b>0402</b>				<b>0603</b>					<b>0805</b>						
<b>VOLTAGE (V<sub>DC</sub>)</b>		16	25	50	100	16	25	50	100	200	16	25	50	100	200	250	500
<b>VOLTAGE CODE</b>		J	X	A	B	J	X	A	B	C	J	X	A	B	C	P	E
<b>CAP. CODE</b>	<b>CAP.</b>																
121	120 pF	••	••	••	••												
151	150 pF	••	••	••	••												
181	180 pF	••	••	••	••												
221	220 pF	••	••	••	••												
271	270 pF	••	••	••	••												
331	330 pF	••	••	••	••			••	••	••	••	••	••	••	••	••	••
391	390 pF	••	••	••	••	••	••	••	••	••	••	••	••	••	••	••	••
471	470 pF	••	••	••	••	••	••	••	••	••	••	••	••	••	••	••	••
561	560 pF	••	••	••	••	••	••	••	••	••	••	••	••	••	••	••	••
681	680 pF	••	••	••	••	••	••	••	••	••	••	••	••	••	••	••	••
821	820 pF	••	••	••	••	••	••	••	••	••	••	••	••	••	••	••	••
102	1.0 nF	••	••	••	••	••	••	••	••	••	••	••	••	••	••	••	••
122	1.2 nF	••	••	••	••	••	••	••	••	••	••	••	••	••	••	••	••
152	1.5 nF	••	••	••	••	••	••	••	••	••	••	••	••	••	••	••	••
182	1.8 nF	••	••	••	••	••	••	••	••	••	••	••	••	••	••	••	••
222	2.2 nF	••	••	••	••	••	••	••	••	••	••	••	••	••	••	••	••
272	2.7 nF	••	••	••	••	••	••	••	••	••	••	••	••	••	••	••	••
332	3.3 nF	••	••	••	••	••	••	••	••	••	••	••	••	••	••	••	••
392	3.9 nF	••	••	••	••	••	••	••	••	••	••	••	••	••	••	••	••
472	4.7 nF	••	••	••	••	••	••	••	••	••	••	••	••	••	••	••	••
562	5.6 nF	••	••	••	••	••	••	••	••	••	••	••	••	••	••	••	••
682	6.8 nF	••	••	••	••	••	••	••	••	••	••	••	••	••	••	••	••
822	8.2 nF	••	••	••	••	••	••	••	••	••	••	••	••	••	••	••	••
103	10 nF	••	••	••	••	••	••	••	••	••	••	••	••	••	••	••	••
123	12 nF	••	••	••	••	••	••	••	••	••	••	••	••	••	••	••	••
153	15 nF	••	••	••	••	••	••	••	••	••	••	••	••	••	••	••	••
183	18 nF	••	••	••	••	••	••	••	••	••	••	••	••	••	••	••	••
223	22 nF	••	••	••	••	••	••	••	••	••	••	••	••	••	••	••	••
273	27 nF	••	••	••	••	••	••	••	••	••	••	••	••	••	••	••	••
333	33 nF	••	••	••	••	••	••	••	••	••	••	••	••	••	••	••	••
393	39 nF	••	••	••	••	••	••	••	••	••	••	••	••	••	••	••	••
473	47 nF	••	••	••	••	••	••	••	••	••	••	••	••	••	••	••	••
563	56 nF	••	••	••	••	••	••	••	••	••	••	••	••	••	••	••	••
683	68 nF	••	••	••	••	••	••	••	••	••	••	••	••	••	••	••	••
823	82 nF	••	••	••	••	••	••	••	••	••	••	••	••	••	••	••	••
104	100 nF	••	••	••	••	••	••	••	••	••	••	••	••	••	••	••	••
124	120 nF	••	••	••	••	••	••	••	••	••	••	••	••	••	••	••	••
154	150 nF	••	••	••	••	••	••	••	••	••	••	••	••	••	••	••	••
184	180 nF	••	••	••	••	••	••	••	••	••	••	••	••	••	••	••	••
224	220 nF	••	••	••	••	••	••	••	••	••	••	••	••	••	••	••	••
274	270 nF	••	••	••	••	••	••	••	••	••	••	••	••	••	••	••	••
334	330 nF	••	••	••	••	••	••	••	••	••	••	••	••	••	••	••	••
394	390 nF	••	••	••	••	••	••	••	••	••	••	••	••	••	••	••	••
474	470 nF	••	••	••	••	••	••	••	••	••	••	••	••	••	••	••	••
564	560 nF	••	••	••	••	••	••	••	••	••	••	••	••	••	••	••	••
684	680 nF	••	••	••	••	••	••	••	••	••	••	••	••	••	••	••	••
824	820 nF	••	••	••	••	••	••	••	••	••	••	••	••	••	••	••	••
105	1.0 μF																
125	1.2 μF																
155	1.5 μF																
185	1.8 μF																
225	2.2 μF																
275	2.7 μF																
335	3.3 μF																
395	3.9 μF																
475	4.7 μF																
565	5.6 μF																
685	6.8 μF																

- Notes**
- Paper tape, • Plastic tape, ++ Paper tape, + Plastic tape, see table “Product drawings (in use)”
  - For soldering conditions see Vishay Soldering Recommendations [www.vishay.com/doc?45034](http://www.vishay.com/doc?45034)
  - Yellow shading: RoHS and ELV (end-of-life vehicles) compliant
  - Orange shading: Not RoHS and ELV (end-of-life vehicles) compliant



SELECTION CHART																		
DIELECTRIC		X7R																
STYLE		VJ1206					VJ1210					VJ1812						
CASE CODE		1206					1210					1812						
VOLTAGE (V <sub>DC</sub> )		16	25	50	100	200	500 / 630	16	25	50	100	200	500 / 630	50	100	200	500	630
VOLTAGE CODE		J	X	A	B	C	E / L	J	X	A	B	C	E / L	A	B	C	E	L
CAP. CODE	CAP.																	
121	120 pF																	
151	150 pF																	
181	180 pF																	
221	220 pF						•											
271	270 pF						•											
331	330 pF						•											
391	390 pF						•					•						
471	470 pF						•					•						
561	560 pF						•					•						
681	680 pF						•					•						
821	820 pF			•	•	•	•					•						
102	1.0 nF	•	•	•	•	•	•					•						
122	1.2 nF	•	•	•	•	•	•					•						
152	1.5 nF	•	•	•	•	•	•					•						
182	1.8 nF	•	•	•	•	•	•					•						
222	2.2 nF	•	•	•	•	•	•					•						
272	2.7 nF	•	•	•	•	•	•					•						
332	3.3 nF	•	•	•	•	•	•					•						
392	3.9 nF	•	•	•	•	•	•					•						
472	4.7 nF	•	•	•	•	•	•					•						
562	5.6 nF	•	•	•	•	•	•					•						
682	6.8 nF	•	•	•	•	•	•					•						
822	8.2 nF	•	•	•	•	•	•					•						
103	10 nF	•	•	•	•	•	•	•	•	•	•	•				•	•	•
123	12 nF	•	•	•	•	•	•	•	•	•	•	•				•	•	•
153	15 nF	•	•	•	•	•	•	•	•	•	•	•				•	•	•
183	18 nF	•	•	•	•	•	+	•	•	•	•	•				•	•	•
223	22 nF	•	•	•	•	•		•	•	•	•	•	+	•	•	•	•	•
273	27 nF	•	•	•	•	•		•	•	•	•	•	+	•	•	•	•	•
333	33 nF	•	•	•	•	•		•	•	•	•	•	+	•	•	•	•	•
393	39 nF	•	•	•	•	•		•	•	•	•	•	+	•	•	•	•	•
473	47 nF	•	•	•	•	•		•	•	•	•	•		•	•	•	•	•
563	56 nF	•	•	•	•	•		•	•	•	•	•		•	•	•	•	•
683	68 nF	•	•	•	•	•		•	•	•	•	•		•	•	•	•	•
823	82 nF	•	•	•	•	+		•	•	•	•	•		•	•	•	•	•
104	100 nF	•	•	•	+	+		•	•	•	+	+		•	•	•	•	
124	120 nF	•	•	•	+	+		•	•	•	+	+		•	•	•	•	
154	150 nF	•	•	+	+			•	•	•	+	+		•	•	•	•	
184	180 nF	•	•	+	+			•	•	•	+	+		•	•	•	•	
224	220 nF	+	+	+	+			+	+	+	+			•	•	•	•	
274	270 nF	+	+	+	+			+	+	+	+			•	•	•	•	
334	330 nF	+	+	+				+	+	+	+			•	•			
394	390 nF	+	+	+				+	+	+	+			•	•			
474	470 nF	+	+	+				+	+	+	+			•	•			
564	560 nF	+	+					+	+	+				•	•			
684	680 nF	+	+					+	+	+				•	•			
824	820 nF	+	+					+	+	+				•	•			
105	1.0 µF	+	+					+	+	+				•				
125	1.2 µF																	
155	1.5 µF																	
185	1.8 µF																	
225	2.2 µF																	
275	2.7 µF																	
335	3.3 µF																	
395	3.9 µF																	
475	4.7 µF																	
565	5.6 µF																	
685	6.8 µF																	

Notes

- Paper tape, • Plastic tape, ++ Paper tape, + Plastic tape, see table "Product drawings (in use)"
- For soldering conditions see Vishay Soldering Recommendations [www.vishay.com/doc?45034](http://www.vishay.com/doc?45034)
- Light Green: RoHS and ELV (end-of-life vehicles) compliant
- Light Orange: Not RoHS and ELV (end-of-life vehicles) compliant





SELECTION CHART														
DIELECTRIC		X8R												
STYLE		VJ0402			VJ0603			VJ0805			VJ1206		VJ1210	
CASE CODE		0402			0603			0805			1206		1210	
VOLTAGE (V <sub>DC</sub> )		25	50	100	25	50	100	25	50	100	25	50	25	50
VOLTAGE CODE		X	A	B	X	A	B	X	A	B	X	A	X	A
CAP. CODE	CAP.													
101	100 pF													
121	120 pF													
151	150 pF													
181	180 pF													
221	220 pF													
271	270 pF													
331	330 pF	••	••	••										
391	390 pF	••	••	••										
471	470 pF	••	••	••		••	••	••	••	••				
561	560 pF	••	••	••		••	••	••	••	••				
681	680 pF	••	••	••	••	••	••	••	••	••				
821	820 pF	••	••	••	••	••	••	••	••	••				
102	1.0 nF	••	••	••	••	••	••	••	••	••	•	•		
122	1.2 nF	••	••	••	••	••	••	••	••	••	•	•		
152	1.5 nF	••	••		••	••	••	••	••	••	•	•		
182	1.8 nF	••	••		••	••	••	••	••	••	•	•		
222	2.2 nF	••	••		••	••	••	••	••	••	•	•		
272	2.7 nF	••			••	••	••	••	••	••	•	•		
332	3.3 nF	••			••	••	••	••	••	••	•	•		
392	3.9 nF	••			••	••	••	••	••	••	•	•		
472	4.7 nF	••			••	••	••	••	••	••	•	•		
562	5.6 nF	••			••	••	••	••	••	••	•	•		
682	6.8 nF	••			••	••	••	••	••	••	•	•		
822	8.2 nF				••	••	••	••	••	••	•	•		
103	10 nF				••	••	••	••	••	••	•	•	•	•
123	12 nF				••	••	••	••	••	••	•	•	•	•
153	15 nF				••	••	••	••	••	••	•	•	•	•
183	18 nF				••	••	••	••	••	••	•	•	•	•
223	22 nF				••	••	••	••	••	•	•	•	•	•
273	27 nF				••	••	••	••	•	•	•	•	•	•
333	33 nF				••	••	••	••	•	•	•	•	•	•
393	39 nF							••	•	•	•	•	•	•
473	47 nF							•	•	•	•	•	•	•
563	56 nF							•	•	•	•	•	•	•
683	68 nF							•	•	•	•	•	•	•
823	82 nF							•	•	•	•	•	•	•
104	100 nF							•	•	•	•	•	•	•
124	120 nF										•	•	•	•
154	150 nF										•	•	•	•
184	180 nF										•	•	•	•
224	220 nF										•	•	•	•
274	270 nF												•	•
334	330 nF												•	•
394	390 nF													
474	470 nF													
564	560 nF													
684	680 nF													
824	820 nF													
105	1.0 μF													
125	1.2 μF													

Notes

- Paper tape, • Plastic tape
- For soldering conditions see Vishay Soldering Recommendations [www.vishay.com/doc?45034](http://www.vishay.com/doc?45034)
- Green background: RoHS and ELV (end-of-life vehicles) compliant
- Orange background: Not RoHS and ELV (end-of-life vehicles) compliant



PRODUCT DRAWING (in use)					
CASE CODE	CODE	X - TERMINATION CODE (100 % MATTE TIN)		F - TERMINATION CODE (AgPd)	
		DRAWING C0G (NPO)	DRAWING X7R	DRAWING C0G (NPO)	DRAWING X7R
0402	•• = paper tape	-	9172	-	9072
	++ = paper tape	7172	7172	7072	7072
0603	•• = paper tape	-	9155	-	9097
	++ = paper tape	7155	7155	7097	7097
	• = plastic tape	-	-	7179	9097
	+ = plastic tape	7155	7155	7097	7097
0805	•• = paper tape	-	9156	-	9080
	++ = paper tape	7156	7156	7080	7080
	• = plastic tape	-	9156	7188	9080
	+ = plastic tape	7156	7156	7080	7080
1206	•• = paper tape	-	-	-	-
	• = plastic tape	-	9157	7180	9081
	+ = plastic tape	7157	7157	7081	7081
1210	• = plastic tape	-	9158	-	9099
	+ = plastic tape	7158	7158	7099	7099

STANDARD PACKAGING QUANTITIES (1)(2)					
CASE CODE	TAPE SIZE	7" REEL QUANTITIES		11 1/4" AND 13" REEL QUANTITIES	
		PAPER TAPE PACKAGING CODE "C" / "O" (4)	PLASTIC TAPE PACKAGING CODE "E" / "T" (6)	PAPER TAPE PACKAGING CODE "P" / "I" (4)	PLASTIC TAPE PACKAGING CODE "M" / "R" (6)
0402	8 mm	5000 / 10 000 (3)	n/a	10 000 / 30 000 (3)	n/a
0603 (7)	8 mm	4000	4000	10 000	10 000
0805 (5)(7)	8 mm	3000	3000	10 000	10 000
1206 (5)(7)	8 mm	3000	2500 / 3000	10 000	9000 / 10 000
1210 (5)	8 mm	n/a	2000 / 2500 / 3000	n/a	9000 / 10 000
1812	12 mm	n/a	1000	n/a	4000

**Notes**

- (1) Reference: EIA standard RS 481 - "Taping of Surface Mount Components for Automatic Placement"
- (2) n/a = not available
- (3) Quantity can vary with customer request
- (4) Flamed paper tape code "O" (7" reel) and "I" (11 1/4" / 13" reel) for AgPd terminated parts (termination code F, E)
- (5) Packaging "C" / "P" or "E" / "M" and quantity can depend from product thickness
- (6) Packaging code "T", "R" are used for size 1812.
- (7) Polymer termination, code "B", only available in plastic tape "E" / "M"



## 1 - GENERAL CERTIFICATES

# Quality management system according to ISO/IATF 16949: 2016	Yes
# Quality management system according to ISO 9001: 2015	Yes
# Environmental certification according to ISO 14001: 2015	Yes
# Health and safety system according to ISO 45001	Yes

## 2 - TECHNICAL REQUIREMENTS

Unless specified in component specification, these parameters are the minimum requirements for the components.

### 2.1 OPERATING TEMPERATURE RANGE

For standard applications	T <sub>A</sub> : -55 °C to +125 °C	See characteristics 2.3
For high temperature applications	T <sub>A</sub> : -55 °C to +150 °C	See characteristics 2.3
For ultra high temperature applications	T <sub>A</sub> : -55 °C to +175 °C	See characteristics 2.3

### 2.2 STORAGE AND HANDLING CONDITIONS

- (1) Store the components at 5 °C to 40 °C ambient temperature and ≤ 70 % relative humidity conditions.  
 (2) The product is recommended to be used within a time-frame of 2 years after shipment.  
 Check solderability in case extended shelf life beyond the expiry date is needed.

Precautions:

- Do not store products in an environment containing corrosive elements, especially where chloride gas, sulfide gas, acid, alkali, salt or the like are present. This may cause corrosion or oxidation of the terminations, which can easily lead to poor soldering.
- Store products on the shelf and avoid exposure to moisture or dust.
- Do not expose products to excessive shock, vibration, direct sunlight and so on.

### 2.3 CHARACTERISTICS

PARAMETER	CERAMIC TYPE	SYMBOL	RATINGS	TEST CONDITIONS/ REMARKS
Rated voltage in temperature range -55 °C to +125 °C	C0G (NP0)	U <sub>R</sub>	25 V to 3000 V	
	X7R		16 V to 630 V	
Rated voltage in temperature range -55 °C to +150 °C	X8R		25 V to 100 V	
Derating at higher temperature up to +150 °C	C0G (NP0),		25 V to 100 V	U <sub>DC</sub> ≤ 1/2 U <sub>R</sub>
	X7R		16 V to 100 V	U <sub>DC</sub> ≤ 1/2 U <sub>R</sub> U <sub>DC</sub> ≤ 1/4 U <sub>R</sub> for VJ0603Y104*A (100 nF / 50 V)
Derating at higher temperature up to +175 °C	C0G (NP0),		25 V to 100 V	U <sub>DC</sub> ≤ 1/4 U <sub>R</sub>
	X7R		16 V to 100 V	U <sub>DC</sub> ≤ 1/4 U <sub>R</sub>
	X8R		25 V to 100 V	U <sub>DC</sub> ≤ 1/4 U <sub>R</sub>
Temperature coefficient in temperature range -55 °C to +125 °C	C0G (NP0)	α <sub>C</sub>	≤ ± 30 ppm/°C	if C <sub>R</sub> < 10 pF: α <sub>C</sub> ≤ ± 120 ppm/°C
	X7R	ΔC	≤ ± 15 %	
Temperature coefficient in temperature range -55 °C to +150 °C	C0G (NP0)	α <sub>C</sub>	≤ ± 30 ppm/°C	if C <sub>R</sub> < 10 pF: α <sub>C</sub> ≤ ± 120 ppm/°C
	X7R	ΔC	+15 %/-30 %	
	X8R		≤ ± 15 %	
Temperature coefficient in temperature range -55 °C to +175 °C	X7R	ΔC	+ 15 %/-50 %	
Dissipation factor in temperature range -55 °C to +175 °C	C0G (NP0)	tan δ	≤ 0.0015	
	X7R		≤ 0.06	
	X8R		≤ 0.06	



**COG (NP0) DIELECTRIC - TYPICAL PARAMETERS**

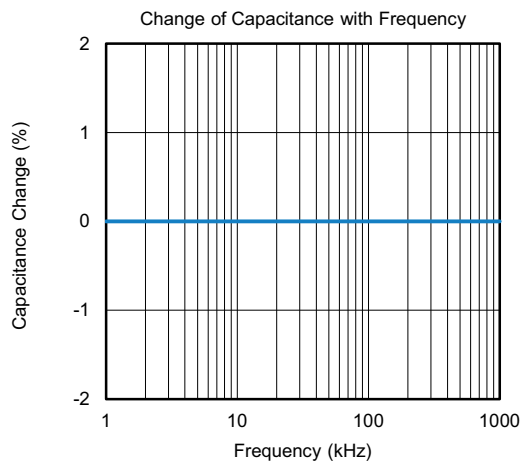
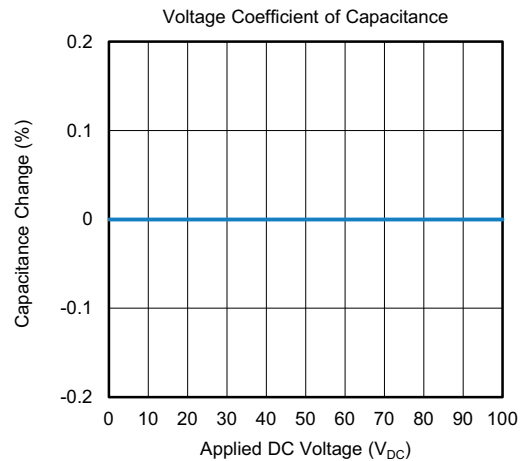
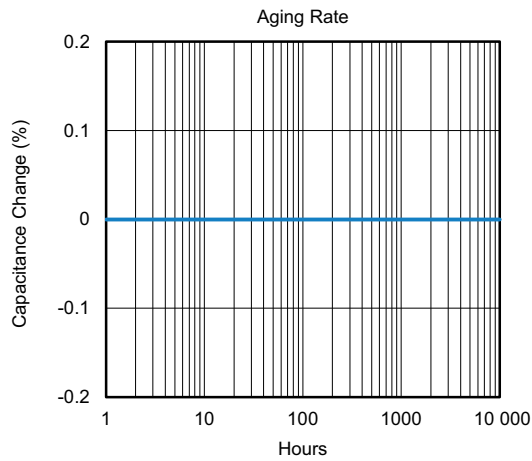
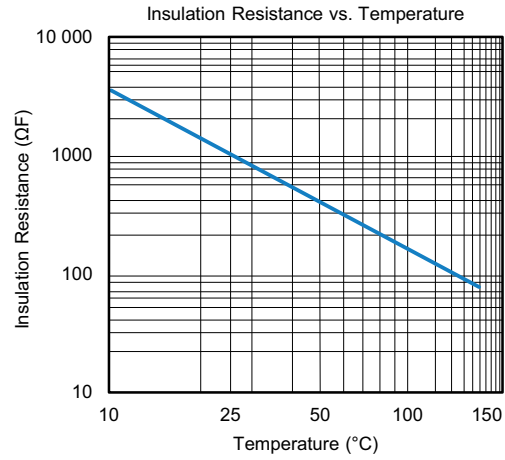
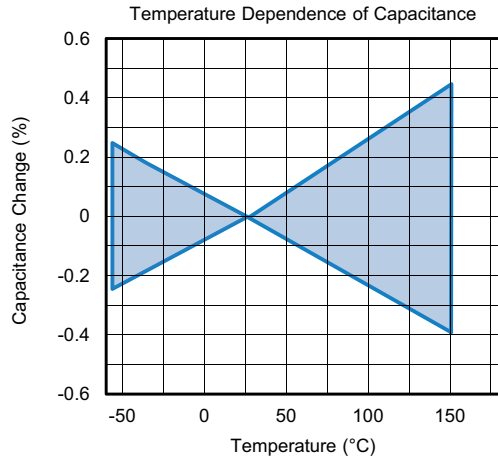



**X7R DIELECTRIC - TYPICAL PARAMETERS**

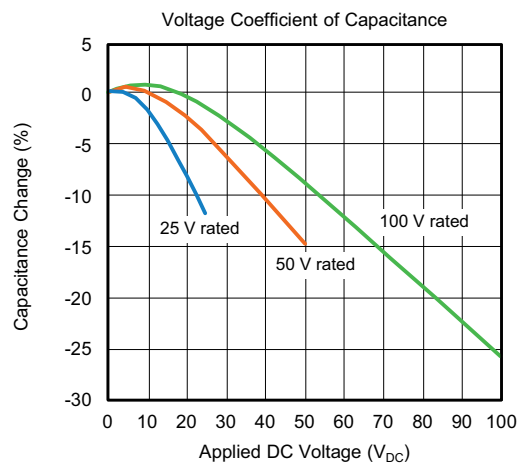
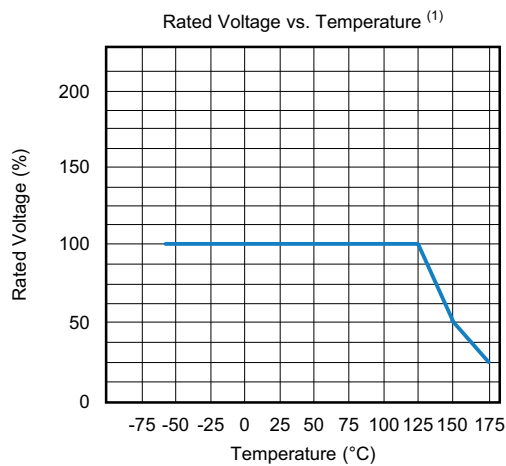
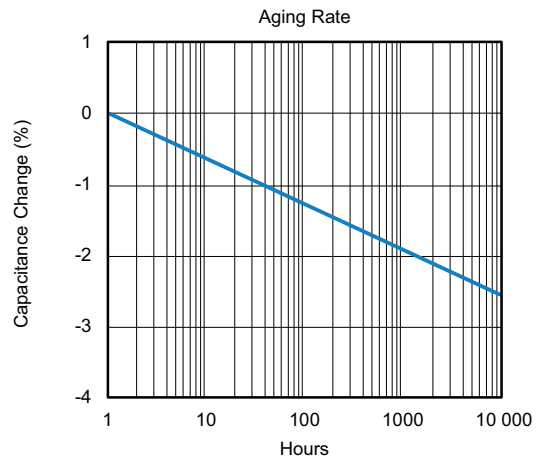
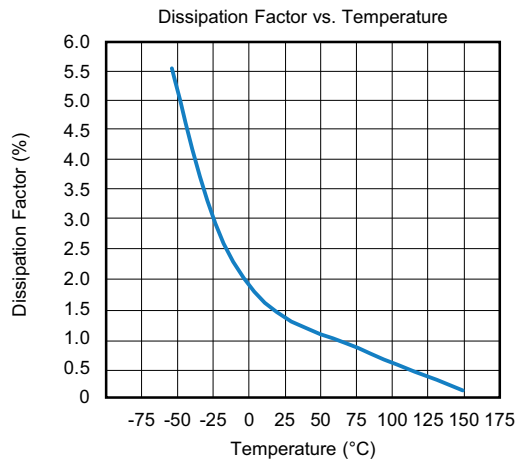
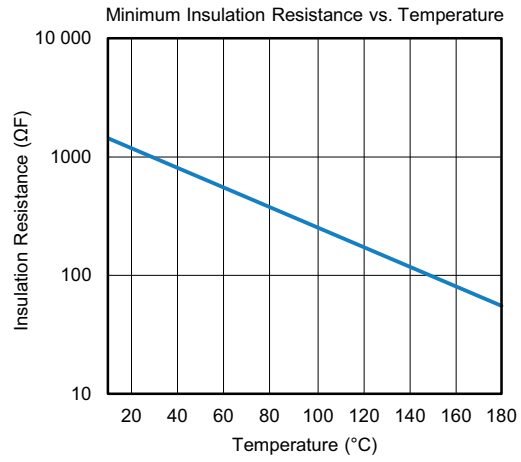
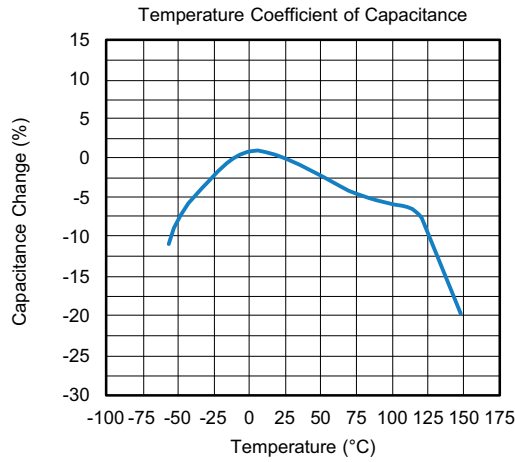

**Note**

<sup>(1)</sup> Except for VJ0603Y104\*A (100 nF / 50 V), see section “2.3 Characteristics”



**X7R DIELECTRIC - TYPICAL PARAMETERS**

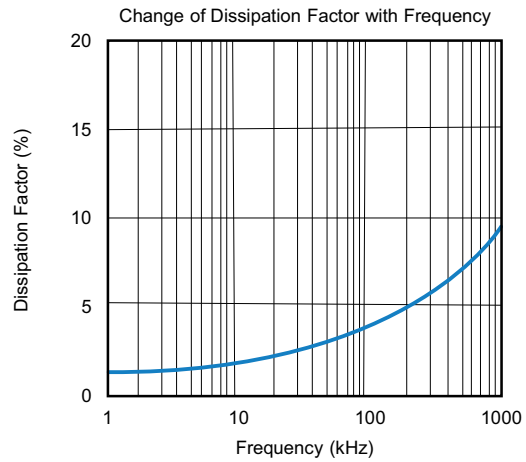
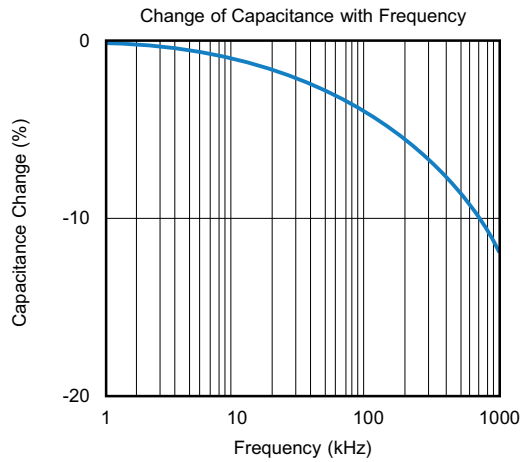
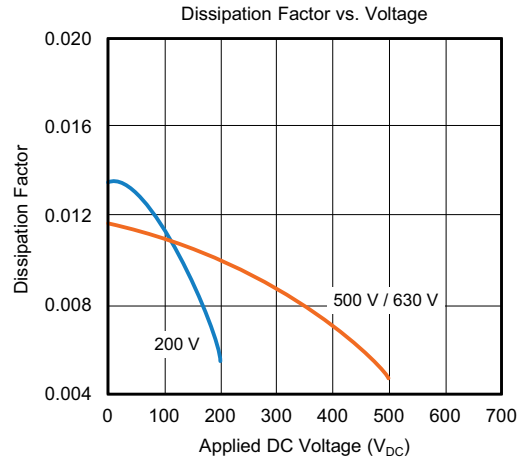
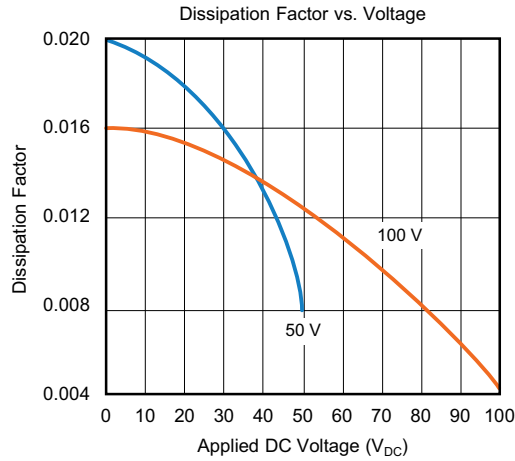



**X8R DIELECTRIC - TYPICAL PARAMETERS**

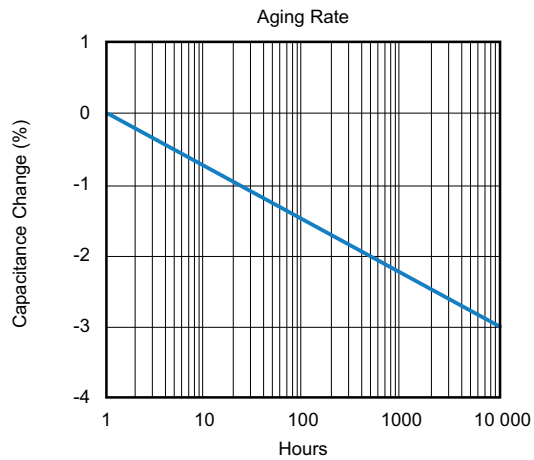
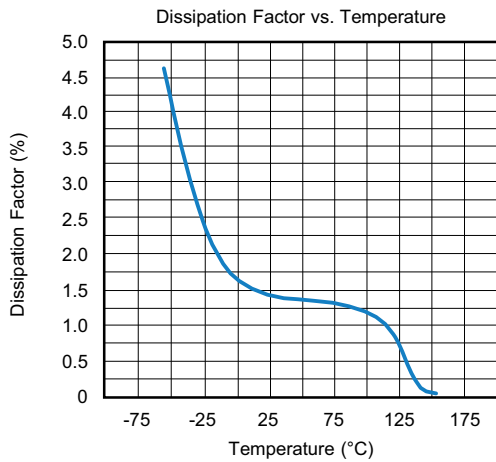
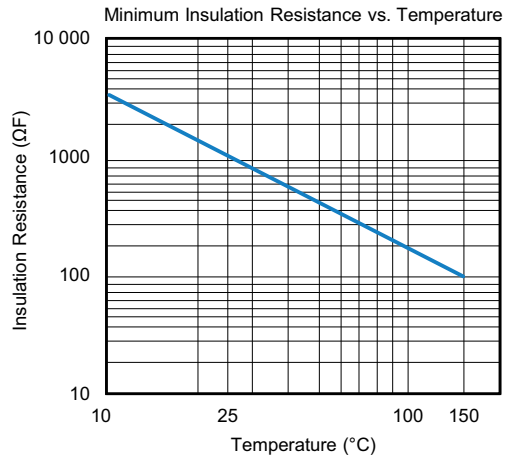
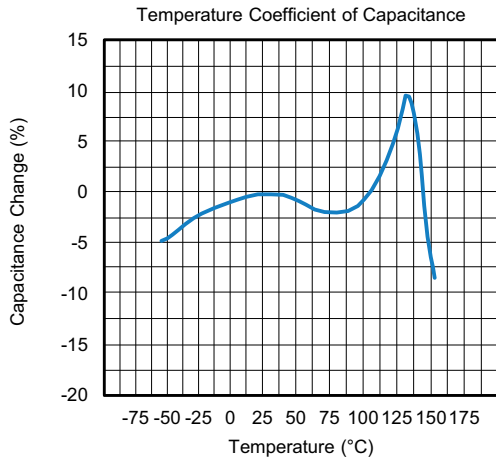



**3 - LOT ACCEPTANCE TESTS**

Process tests available in classes (on request)

GROUP	ACTION
A	Components are tested within the monitoring program of the supplier. The supplier shall submit the part numbers of the selected component to the customer during the component specification discussions.
B	Components (customer P/N) shall be tested quarterly. Records available only on special request by the customer.
C	Test with each shipment. Records are provided on a monthly basis. Customer special requirement; requirement should be determined in a specific component specification.

Upon request the records can be submitted in electronic format on monthly basis.

**3.1 THERMAL STRENGTH, THERMAL SHOCK SENSIBILITY**

Sample size	200
Handling	Mounted on PCB
Thermal shock	1 x 280 °C, no pre-heat, 5 s to 10 s
IR - test (IRATS)	U = U <sub>R</sub> , T = room temperature, verified
Burn in (BIATS)	Equivalent to 12 h burn-in, 2 x U <sub>R</sub> /125 °C, verification time to failure

Acceptance criteria: zero defects (IRATS and BIATS).

**3.2 BOARD FLEX TEST**

Sample size	20 pcs/lot
Frequency	At least three different part numbers of one component family matrix per quarter
Max. deflection	8 mm (data to be reported, available on request)

**3.3 SOLDERABILITY/RESISTANCE TO SOLDERING HEAT**

Temperature profile for reflow soldering of SMD parts IPC/JEDEC-J-STD-020C.

Test is done on a regular basis for samples taken randomly out of the line.

Acceptance criteria: at least 95 % new solder and no detachment or leaching of terminations.

**4 - ENVIRONMENTAL REQUIREMENTS**

A list of the chemical substances content, which must not be used or whose use shall be limited by international law, is available on request.

Vishay confirms that the components specified in this specification do not contain asbestos nor cadmium, not even in the smallest volumes.

The manufacturer/supplier confirms that the component during normal handling, storage and assembly, as well as during operation in the automobile, is non toxic.





### 5 - INSPECTION CRITERIA

The supplier shall carry out visual examination with suitable equipment with approximately 10 x magnification and lighting appropriate to the specimen under test and the required quality level.

#### Chipping

The components shall be free of cracks or fissures. Small damages which do not deteriorate the performance of the component shall be less than 50 % of the surface of the MLCC as defined in EIA 595.

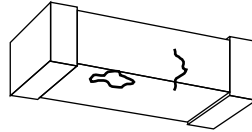

#### Delamination or Exposed Electrodes

No visible separation or delamination between layers of the capacitor and no exposed electrodes between the two terminals of the capacitor must be seen.

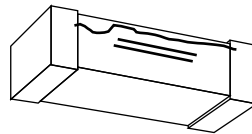

#### Metallization

For the metallization, no visible detachment of the metallized terminals and no exposed electrodes must be seen. Defects and gaps in the metallization on each sides of the terminal must not exceed 10 % of the total area (e.g. A, B, C, ...). Leaching shall not exceed 25 %.

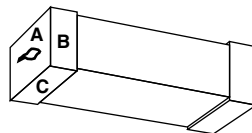

#### Electrode Distance

The ceramic body shall be free of any conducting material between the terminals which reduces the distance of the electrodes. The minimum distance "D" is 400 μm for all package sizes, except 0402. For the component package 0402 the minimum distance is 200 μm.

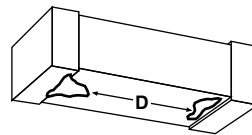



**6 - BOARD FLEX TEST CONDITIONS**

**6.1 BOARD FLEX DEFINITIONS OF TEST**

PCB thickness = (1.6 ± 0.1) mm

Copper thickness = 35 µm

Material FR4 (EP-GC 02 according to DIN 40 802)

LAYOUT/PAD DESIGN (Dimensions in mm)			
CASE CODE	PAD SIZE		
	LL	LB	LEL
0603	2.20	1.00	0.75
0805	3.40	1.30	1.20
1206	4.50	1.80	1.20
1210	4.50	2.80	1.30
1812	4.75	3.60	1.50

**Note**

- LL = total length; LB = width of the pad; LEL = single pad length

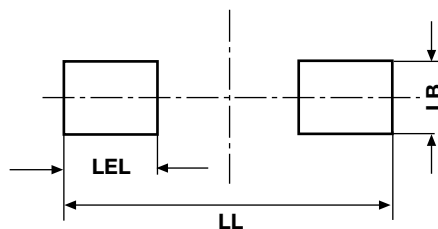

**6.2 SOLDERING INSTRUCTIONS**

THICKNESS, RECOMMENDED FOR SOLDER PASTE (Reflow soldering)	
CASE CODE	THICKNESS in µm
0402	75 to 90
0603	150 to 200
0805	150 to 200
1206	150 to 200
1210	150 to 200
1812	150 to 200

**6.3 TYPICAL TEMPERATURE PROFILE FOR REFLOW SOLDERING (Boardflex test)**

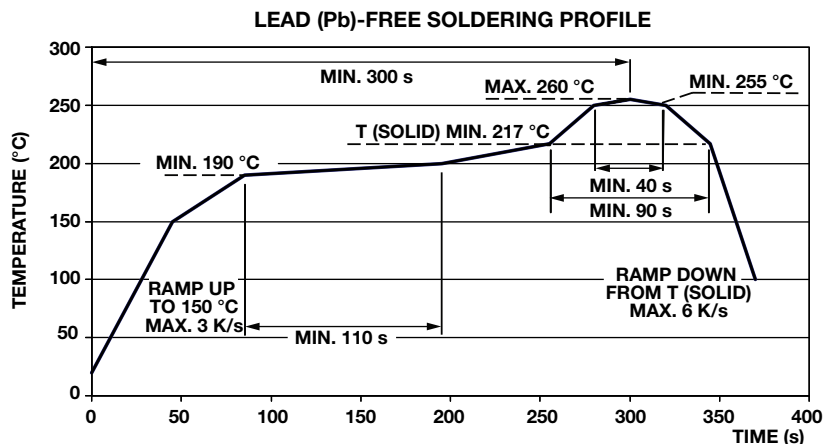



### 6.4 MOUNTING, DIMENSIONS AND TESTING

#### Mounting

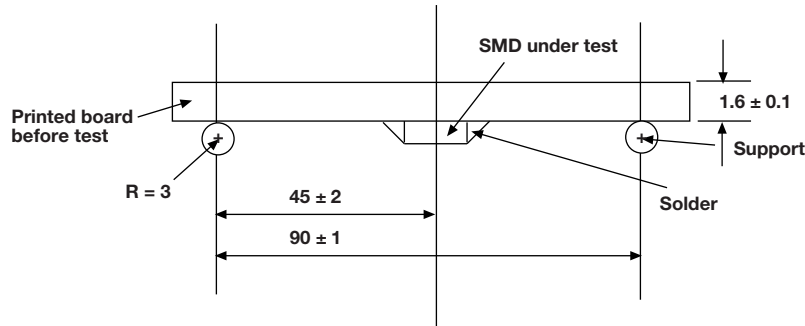

#### Testing

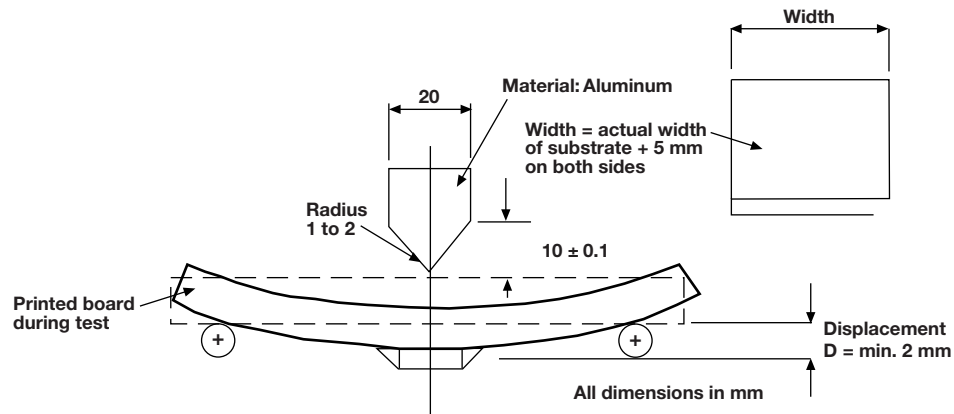

### 6.5 PERFORMANCE OF THE TEST(S)

- A) Electrical test according to component specification (Cap, DF, IR)
- B) Mounting to PCB
- C) Storage at room temperature (min. 10 h)
- D) Board flex test

### 6.6 DETAILS

<b>X7R, X8R</b>	PCB to be deflected continuously, speed 1 mm/s ( $\pm 0.5$ mm/s)
<b>C0G</b>	PCB to be deflected in steps until cracks or other damages are visible or can be measured. Dwell time between steps: ( $5 \pm 1$ ) s

### 6.7 FAILURE CRITERIA

<b>X7R, X8R</b>	Piezoelectric sensor, no failures up to min. 2 mm
<b>C0G (NP0)</b>	$\Delta C/C < 1\%$ or $< 1$ pF, no failures up to min. 2 mm
<b>Both</b>	Electrical test according to component specification



**7 - AEC-Q200 QUALIFICATION TESTING**

NO.	AEC-Q200 TEST ITEM	REFERENCE
1	Pre- and post stress electrical test	User spec
3	High temp exposure (storage)	MIL-STD-202, method 108
4	Temperature cycling	JESD22, method JA-104
5	Destructive physical analysis	EIA-469
6	Moisture resistance	MIL-STD-202, method 106
7	Biased humidity	MIL-STD-202, method 103
8	Operation life	MIL-STD-202 method 108
9	External Visual	MIL-STD-883 method 2009
10	Physical dimension	JESD22, method JB-100
13	Mechanical shock	MIL-STD-202, method 213
14	Vibration	MIL-STD-202, method 204
15	Resistance to solder heat	MIL-STD-202, method 210
17	ESD	AEC-Q200-002
18	Solderability	J-STD-002
19	Electrical characterization	User spec
21	Board flex	AEC-Q200-005
22	Terminal strength	AEC-Q200-006
23	Beam load	AEC-Q200-003



## Disclaimer

ALL PRODUCT, PRODUCT SPECIFICATIONS AND DATA ARE SUBJECT TO CHANGE WITHOUT NOTICE TO IMPROVE RELIABILITY, FUNCTION OR DESIGN OR OTHERWISE.

Vishay Intertechnology, Inc., its affiliates, agents, and employees, and all persons acting on its or their behalf (collectively, "Vishay"), disclaim any and all liability for any errors, inaccuracies or incompleteness contained in any datasheet or in any other disclosure relating to any product.

Vishay makes no warranty, representation or guarantee regarding the suitability of the products for any particular purpose or the continuing production of any product. To the maximum extent permitted by applicable law, Vishay disclaims (i) any and all liability arising out of the application or use of any product, (ii) any and all liability, including without limitation special, consequential or incidental damages, and (iii) any and all implied warranties, including warranties of fitness for particular purpose, non-infringement and merchantability.

Statements regarding the suitability of products for certain types of applications are based on Vishay's knowledge of typical requirements that are often placed on Vishay products in generic applications. Such statements are not binding statements about the suitability of products for a particular application. It is the customer's responsibility to validate that a particular product with the properties described in the product specification is suitable for use in a particular application. Parameters provided in datasheets and / or specifications may vary in different applications and performance may vary over time. All operating parameters, including typical parameters, must be validated for each customer application by the customer's technical experts. Product specifications do not expand or otherwise modify Vishay's terms and conditions of purchase, including but not limited to the warranty expressed therein.

Hyperlinks included in this datasheet may direct users to third-party websites. These links are provided as a convenience and for informational purposes only. Inclusion of these hyperlinks does not constitute an endorsement or an approval by Vishay of any of the products, services or opinions of the corporation, organization or individual associated with the third-party website. Vishay disclaims any and all liability and bears no responsibility for the accuracy, legality or content of the third-party website or for that of subsequent links.

Except as expressly indicated in writing, Vishay products are not designed for use in medical, life-saving, or life-sustaining applications or for any other application in which the failure of the Vishay product could result in personal injury or death. Customers using or selling Vishay products not expressly indicated for use in such applications do so at their own risk. Please contact authorized Vishay personnel to obtain written terms and conditions regarding products designed for such applications.

No license, express or implied, by estoppel or otherwise, to any intellectual property rights is granted by this document or by any conduct of Vishay. Product names and markings noted herein may be trademarks of their respective owners.