

# Ultra-Low Power RS485 with Low EMI, Shutdown and High Input Impedance

## FEATURES

- **High Input Impedance: Up to 256 Transceivers on the Bus**
- **Low Power:  $I_{CC} = 120\mu\text{A}$  Max with Driver Disabled**
- $I_{CC} = 200\mu\text{A}$  Max with Driver Enabled, No Load
- **$1\mu\text{A}$  Quiescent Current in Shutdown Mode**
- Controlled Slew Rate Driver for Reduced EMI
- Single 5V Supply
- ESD Protection to  $\pm 10\text{kV}$  On Receiver Inputs and Driver outputs
- $-7\text{V}$  to  $12\text{V}$  Common-Mode Range Permits  $\pm 7\text{V}$  Ground Difference Between Devices on the Data Line
- Thermal Shutdown Protection
- Power Up/Down Glitch-Free Driver Outputs Permit Live Insertion or Removal of Transceiver
- Driver Maintains High Impedance in Three-State or with the Power Off
- Pin Compatible with the LTC485

## APPLICATIONS

- Battery-Powered RS485/RS422 Applications
- Low Power RS485/RS422 Transceiver
- Level Translator

## DESCRIPTION

The LTC<sup>®</sup>1487 is an ultra-low power differential line transceiver designed with high impedance inputs allowing up to 256 transceivers to share a single bus. It meets the requirements of RS485 and RS422. The LTC1487 features output drivers with controlled slew rate, decreasing the EMI radiated from the RS485 lines, and improving signal fidelity with miterminated lines. The CMOS design offers significant power savings without sacrificing ruggedness against overload or ESD damage. Typical quiescent current is only  $80\mu\text{A}$  while operating and  $1\mu\text{A}$  in shutdown.

The driver and receiver feature three-state outputs, with the driver outputs maintaining high impedance over the entire common-mode range. Excessive power dissipation caused by bus contention or faults is prevented by a thermal shutdown circuit which forces the driver outputs into a high impedance state. The receiver has a fail-safe feature which guarantees a high output state when the inputs are left open. I/O pins are protected against multiple ESD strikes of over  $\pm 10\text{kV}$  using the Human Body Model.

The LTC1487 is fully specified over the commercial temperature range and is available in 8-pin DIP and SO packages.

 LTC and LT are registered trademarks of Linear Technology Corporation.

## TYPICAL APPLICATION

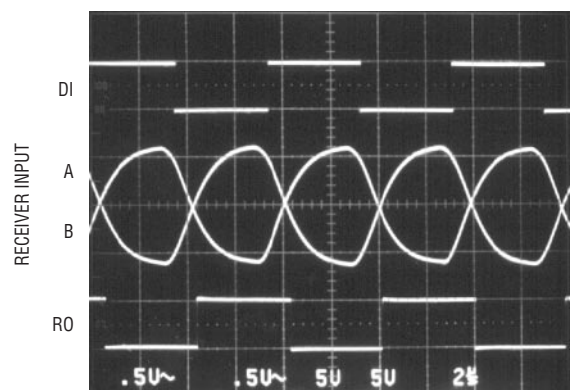
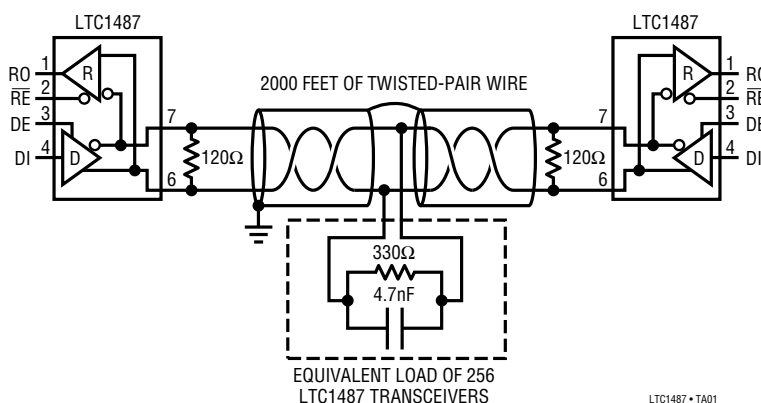

LTC1487 • TA02  
sn1487 1487fs

## ABSOLUTE MAXIMUM RATINGS

(Note 1)

Supply Voltage ( $V_{CC}$ )	12V
Control Input Voltage	-0.5V to $V_{CC} + 0.5V$
Driver Input Voltage	-0.5V to $V_{CC} + 0.5V$
Driver Output Voltage	$\pm 14V$
Receiver Input Voltage	$\pm 14V$
Receiver Output Voltage	-0.5V to $V_{CC} + 0.5V$
Operating Temperature Range	$0^{\circ}C \leq T_A \leq 70^{\circ}C$
Storage Temperature Range	$-65^{\circ}C$ to $150^{\circ}C$
Lead Temperature (Soldering, 10 sec)	$300^{\circ}C$

## PACKAGE/ORDER INFORMATION

<p>N8 PACKAGE 8-LEAD PDIP</p> <p>S8 PACKAGE 8-LEAD PLASTIC SO</p> <p><math>T_{JMAX} = 125^{\circ}C, \theta_{JA} = 130^{\circ}C/W</math> (N8)  <math>T_{JMAX} = 125^{\circ}C, \theta_{JA} = 150^{\circ}C/W</math> (S8)</p>	ORDER PART NUMBER
	LTC1487CN8 LTC1487CS8
	S8 PART MARKING
	1487

Consult factory for Industrial and Military grade parts.

## ELECTRICAL CHARACTERISTICS $0^{\circ}C \leq T_A \leq 70^{\circ}C, V_{CC} = 5V$ (Notes 2, 3) unless otherwise noted.

SYMBOL	PARAMETER	CONDITIONS	MIN	TYP	MAX	UNITS
$V_{OD1}$	Differential Driver Output Voltage (Unloaded)	$I_O = 0$	●		5	V
$V_{OD2}$	Differential Driver Output Voltage (with Load)	$R = 50\Omega$ (RS422) $R = 27\Omega$ (RS485), Figure 1	● ●	2.0 1.5	5	V V
$\Delta V_{OD}$	Change in Magnitude of Driver Differential Output Voltage for Complementary Output States	$R = 27\Omega$ or $R = 50\Omega$ , Figure 1	●		0.2	V
$V_{OC}$	Driver Common-Mode Output Voltage	$R = 27\Omega$ or $R = 50\Omega$ , Figure 1	●		3	V
$\Delta  V_{OC} $	Change in Magnitude of Driver Common-Mode Output Voltage for Complementary Output States	$R = 27\Omega$ or $R = 50\Omega$ , Figure 1	●		0.2	V
$V_{IH}$	Input High Voltage	DE, DI, $\overline{RE}$	●	2		V
$V_{IL}$	Input Low Voltage	DE, DI, $\overline{RE}$	●		0.8	V
$I_{IN1}$	Input Current	DE, DI, $\overline{RE}$	●		$\pm 2$	$\mu A$
$I_{IN2}$	Input Current (A, B)	DE = 0, $V_{CC} = 0V$ or $5.25V, V_{IN} = 12V$ DE = 0, $V_{CC} = 0V$ or $5.25V, V_{IN} = -7V$	● ●		0.30 -0.15	mA mA
$V_{TH}$	Differential Input Threshold Voltage for Receiver	$-7V \leq V_{CM} \leq 12V$	●	-0.2	0.2	V
$\Delta V_{TH}$	Receiver Input Hysteresis	$V_{CM} = 0V$	●	45		mV
$V_{OH}$	Receiver Output High Voltage	$I_O = -4mA, V_{ID} = 200mV$	●	3.5		V
$V_{OL}$	Receiver Output Low Voltage	$I_O = 4mA, V_{ID} = -200mV$	●		0.4	V
$I_{OZR}$	Three-State (High Impedance) Output Current at Receiver	$V_{CC} = Max, 0.4V \leq V_O \leq 2.4V$	●		$\pm 1$	$\mu A$
$R_{IN}$	Receiver Input Resistance	$-7V \leq V_{CM} \leq 12V$	●	70	96	k $\Omega$
$I_{CC}$	Supply Current	No Load, Output Enabled No Load, Output Disabled	● ●	120 80	200 120	$\mu A$ $\mu A$
$I_{SHDN}$	Supply Current in Shutdown Mode	DE = 0V, $\overline{RE} = V_{CC}$		1	10	$\mu A$
$I_{OSD1}$	Driver Short-Circuit Current, $V_{OUT} = HIGH$	$-7V \leq V_O \leq 12V$	●	35	250	mA
$I_{OSD2}$	Driver Short-Circuit Current, $V_{OUT} = LOW$	$-7V \leq V_O \leq 12V$	●	35	250	mA
$I_{OSR}$	Receiver Short-Circuit Current	$0V \leq V_O \leq V_{CC}$	●	7	85	mA

## ELECTRICAL CHARACTERISTICS $-40^{\circ}\text{C} \leq T_A \leq 85^{\circ}\text{C}$ , $V_{CC} = 5\text{V}$ (Note 4) unless otherwise noted.

SYMBOL	PARAMETER	CONDITIONS	MIN	TYP	MAX	UNITS	
$V_{OD1}$	Differential Driver Output Voltage (Unloaded)	$I_O = 0$	●		5	V	
$V_{OD2}$	Differential Driver Output Voltage (with Load)	$R = 50\Omega$ (RS422)	●	2.0		V	
		$R = 27\Omega$ (RS485), Figure 1	●	1.5	5	V	
$V_{OC}$	Driver Common-Mode Output Voltage	$R = 27\Omega$ or $R = 50\Omega$ , Figure 1	●		3	V	
$V_{TH}$	Differential Input Threshold Voltage for Receiver	$-7\text{V} \leq V_{CM} \leq 12\text{V}$	●	-0.2	0.2	V	
$\Delta V_{TH}$	Receiver Input Hysteresis	$V_{CM} = 0\text{V}$	●	45		mV	
$I_{CC}$	Supply Current	No Load, Output Enabled	●	120	200	$\mu\text{A}$	
		No Load, Output Disabled	●	80	120	$\mu\text{A}$	
$I_{SHDN}$	Supply Current in Shutdown Mode	$DE = 0\text{V}$ , $\overline{RE} = V_{CC}$		1	10	$\mu\text{A}$	
$t_{PLH}$	Driver Input to Output	$R_{DIFF} = 54\Omega$ , $C_{L1} = C_{L2} = 100\text{pF}$ , (Figures 3, 5)	●	150	1200	ns	
$t_{PHL}$	Driver Input to Output		●	150	1200	ns	
$t_{SKEW}$	Driver Output to Output		●	100	600	ns	
$t_r, t_f$	Driver Rise or Fall Time		●	150	2000	ns	
$t_{PLH}$	Receiver Input to Output	$R_{DIFF} = 54\Omega$ , $C_{L1} = C_{L2} = 100\text{pF}$ , (Figures 3, 7)	●	30	140	250	ns
$t_{PHL}$	Receiver Input to Output		●	30	140	250	ns
$t_{SKD}$	$ t_{PLH} - t_{PHL} $ Differential Receiver Skew		●	13		ns	
$f_{MAX}$	Maximum Data Rate		●	250		kbps	

## SWITCHING CHARACTERISTICS $0^{\circ}\text{C} \leq T_A \leq 70^{\circ}\text{C}$ , $V_{CC} = 5\text{V}$ (Notes 2, 3) unless otherwise noted.

SYMBOL	PARAMETER	CONDITIONS	MIN	TYP	MAX	UNITS	
$t_{PLH}$	Driver Input to Output	$R_{DIFF} = 54\Omega$ , $C_{L1} = C_{L2} = 100\text{pF}$ , (Figures 3, 5)	●	150	1200	ns	
$t_{PHL}$	Driver Input to Output		●	150	1200	ns	
$t_{SKEW}$	Driver Output to Output		●	250	600	ns	
$t_r, t_f$	Driver Rise or Fall Time		●	150	1200	ns	
$t_{ZH}$	Driver Enable to Output High	$C_L = 100\text{pF}$ (Figures 4, 6), S2 Closed	●	100	1500	ns	
$t_{ZL}$	Driver Enable to Output Low	$C_L = 100\text{pF}$ (Figures 4, 6), S1 Closed	●	100	1500	ns	
$t_{LZ}$	Driver Disable Time from Low	$C_L = 15\text{pF}$ (Figures 4, 6), S1 Closed	●	150	1500	ns	
$t_{HZ}$	Driver Disable Time from High	$C_L = 15\text{pF}$ (Figures 4, 6), S2 Closed	●	150	1500	ns	
$t_{PLH}$	Receiver Input to Output	$R_{DIFF} = 54\Omega$ , $C_{L1} = C_{L2} = 100\text{pF}$ , (Figures 3, 7)	●	30	140	250	ns
$t_{PHL}$	Receiver Input to Output		●	30	140	250	ns
$t_{SKD}$	$ t_{PLH} - t_{PHL} $ Differential Receiver Skew		●	13		ns	
$t_{ZL}$	Receiver Enable to Output Low	$C_{RL} = 15\text{pF}$ (Figures 2, 8), S1 Closed	●	20	50	ns	
$t_{ZH}$	Receiver Enable to Output High	$C_{RL} = 15\text{pF}$ (Figures 2, 8), S2 Closed	●	20	50	ns	
$t_{LZ}$	Receiver Disable from Low	$C_{RL} = 15\text{pF}$ (Figures 2, 8), S1 Closed	●	20	50	ns	
$t_{HZ}$	Receiver Disable from High	$C_{RL} = 15\text{pF}$ (Figures 2, 8), S2 Closed	●	20	50	ns	
$f_{MAX}$	Maximum Data Rate		●	250		kbps	
$t_{SHDN}$	Time to Shutdown	$DE = 0$ , $\overline{RE} = \uparrow$	●	50	200	600	ns

## SWITCHING CHARACTERISTICS $0^{\circ}\text{C} \leq T_A \leq 70^{\circ}\text{C}$ , $V_{CC} = 5\text{V}$ (Notes 2, 3) unless otherwise noted.

SYMBOL	PARAMETER	CONDITIONS	MIN	TYP	MAX	UNITS
$t_{ZH}(\text{SHDN})$	Driver Enable from Shutdown to Output High	$C_L = 100\text{pF}$ (Figures 4, 6), S2 Closed	●		2000	ns
$t_{ZL}(\text{SHDN})$	Driver Enable from Shutdown to Output Low	$C_L = 100\text{pF}$ (Figures 4, 6), S1 Closed	●		2000	ns
$t_{ZH}(\text{SHDN})$	Receiver Enable from Shutdown to Output High	$C_L = 15\text{pF}$ (Figures 2, 8), S2 Closed	●		2000	ns
$t_{ZL}(\text{SHDN})$	Receiver Enable from Shutdown to Output Low	$C_L = 15\text{pF}$ (Figures 2, 8), S1 Closed	●		2000	ns

The ● denotes specifications which apply over the full operating temperature range.

**Note 1:** Absolute maximum ratings are those beyond which the safety of the device cannot be guaranteed.

**Note 2:** All currents into device pins are positive; all currents out of device pins are negative. All voltages are referenced to device ground unless otherwise specified.

**Note 3:** All typicals are given for  $V_{CC} = 5\text{V}$  and  $T_A = 25^{\circ}\text{C}$ .

**Note 4:** The LTC1487 is not tested and is not quality-assurance sampled at  $-40^{\circ}\text{C}$  and at  $85^{\circ}\text{C}$ . These specifications are guaranteed by design, correlation, and/or inference from  $0^{\circ}\text{C}$ ,  $25^{\circ}\text{C}$  and/or  $70^{\circ}\text{C}$  tests.

## TYPICAL PERFORMANCE CHARACTERISTICS

Supply Current vs Temperature

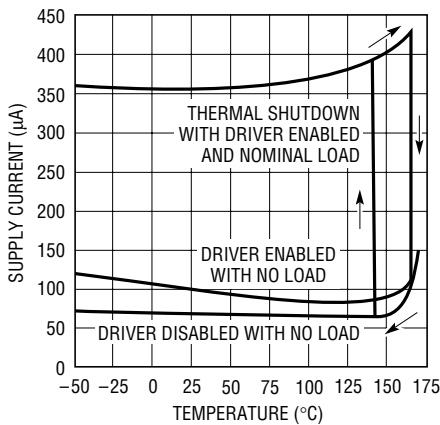

LTC1487 • TPC01

Driver Differential Output Voltage vs Output Current

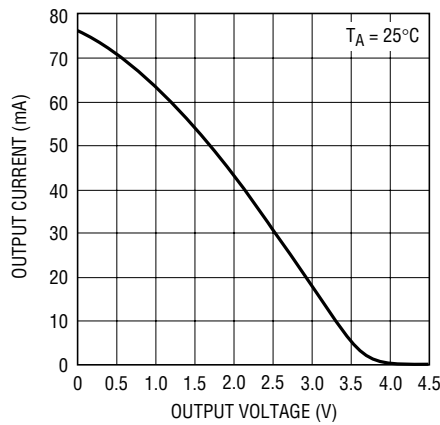

LTC1487 • TPC02

Driver Differential Output Voltage vs Temperature

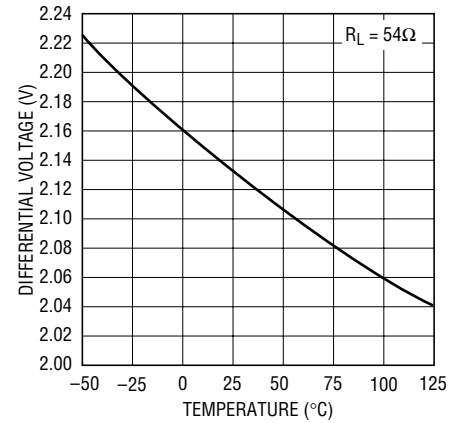

LTC1487 • TPC03

Driver Output Low Voltage vs Output Current

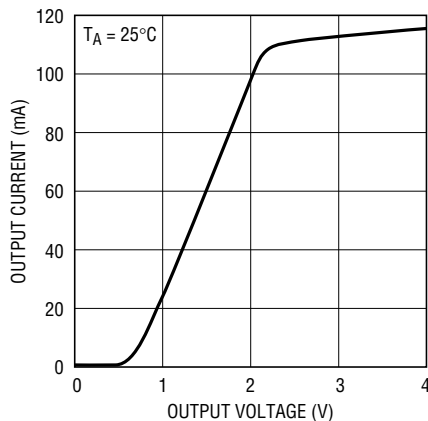

LTC1487 • TPC04

Driver Output High Voltage vs Output Current

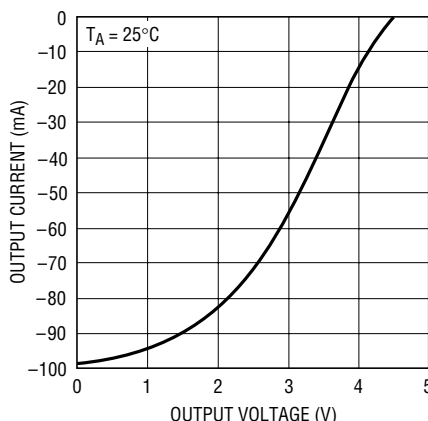

LTC1487 • TPC05

Driver Skew vs Temperature

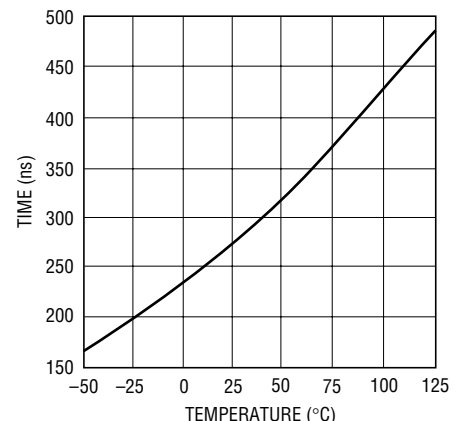

LTC1487 • G06  
sn1487 1487fs

## PIN FUNCTIONS

**RO (Pin 1):** Receiver Output. If the receiver output is enabled ( $\overline{RE}$  LOW), and  $A > B$  by 200mV, RO will be HIGH. If  $A < B$  by 200mV, then RO will be LOW.

**$\overline{RE}$  (Pin 2):** Receiver Output Enable. A LOW enables the receiver output, RO. A HIGH input forces the receiver output into a high impedance state.

**DE (Pin 3):** Driver Outputs Enable. A HIGH on DE enables the driver output. A and B and the chip will function as a line driver. A LOW input will force the driver outputs into a high impedance state and the chip will function as a line receiver. If  $\overline{RE}$  is HIGH and DE is LOW, the part will enter a low power ( $1\mu\text{A}$ ) shutdown state.

**DI (Pin 4):** Driver Input. If the driver outputs are enabled (DE HIGH) then a LOW on DI forces the outputs A LOW and B HIGH. A HIGH on DI with the driver outputs enabled will force A HIGH and B LOW.

**GND (Pin 5):** Ground.

**A (Pin 6):** Driver Output/Receiver Input.

**B (Pin 7):** Driver Output/Receiver Input.

**$V_{CC}$  (Pin 8):** Positive Supply.  $4.75\text{V} < V_{CC} < 5.25\text{V}$ .

## FUNCTION TABLES

LTC1487 Transmitting

INPUTS			OUTPUTS	
$\overline{RE}$	DE	DI	B	A
X	1	1	0	1
X	1	0	1	0
0	0	X	Z	Z
1	0	X	Z*	Z*

\*Shutdown mode

LTC1487 Receiving

INPUTS			OUTPUTS
$\overline{RE}$	DE	A - B	RO
0	0	$\geq 0.2\text{V}$	1
0	0	$\leq -0.2\text{V}$	0
0	0	Inputs Open	1
1	0	X	Z*

\*Shutdown mode

## TEST CIRCUITS

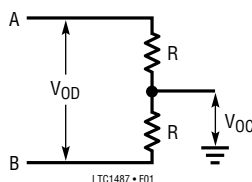

Figure 1. Driver DC Test Load

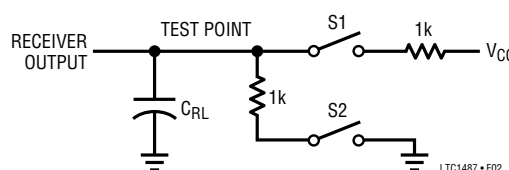

Figure 2. Receiver Timing Test Load

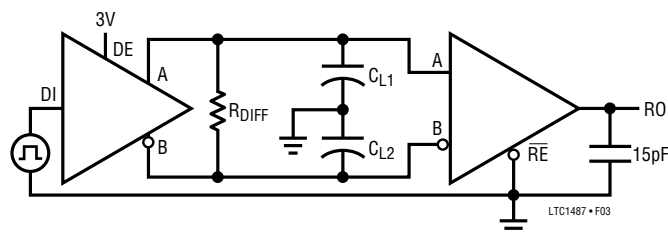

Figure 3. Driver/Receiver Timing Test Circuit

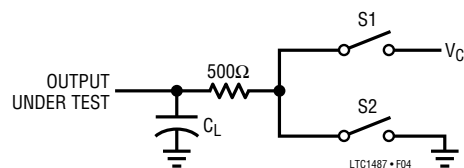

Figure 4. Driver Timing Test Load

sn1487 1487fs

# SWITCHING TIME WAVEFORMS

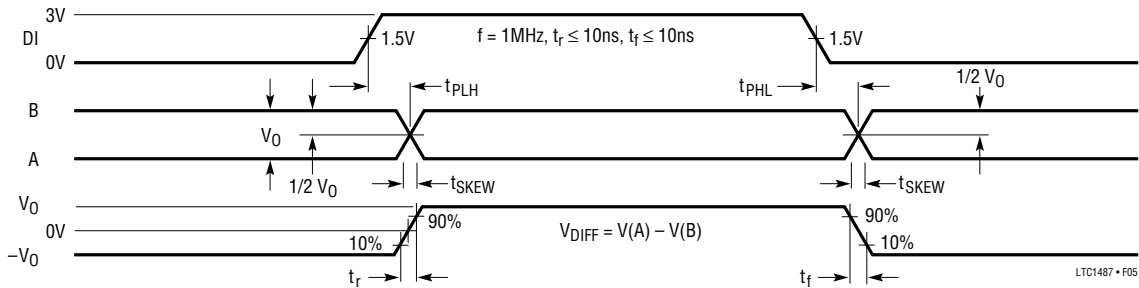

Figure 5. Driver Propagation Delays

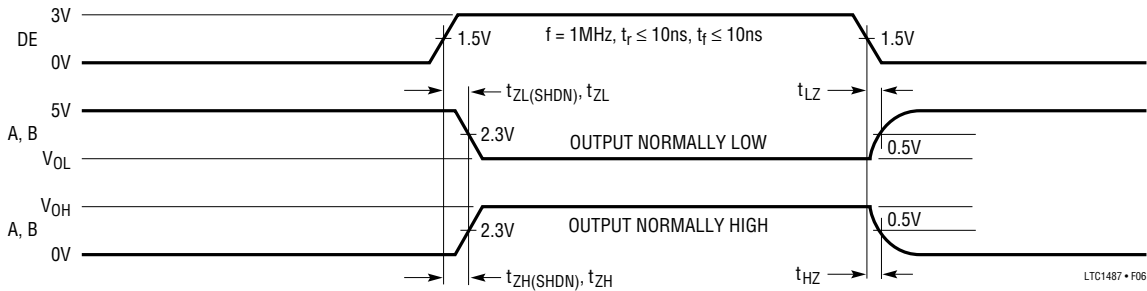

Figure 6. Driver Enable and Disable Times

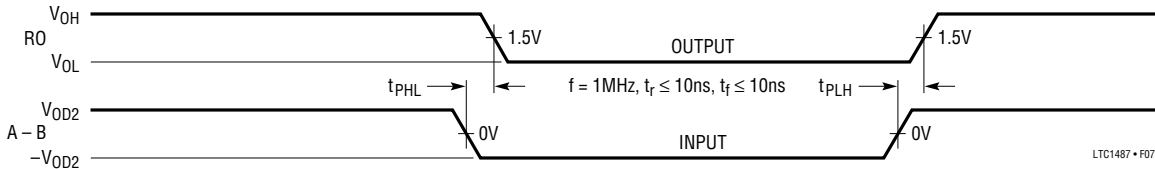

Figure 7. Receiver Propagation Delays

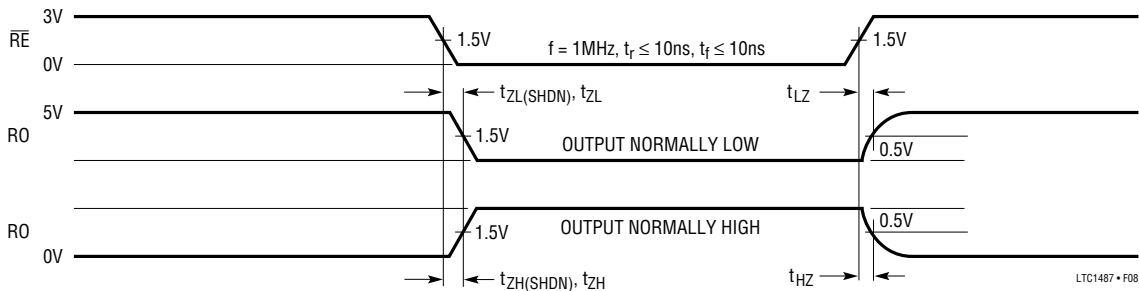

Figure 8. Receiver Enable and Disable Times

## APPLICATIONS INFORMATION

### High Input Impedance

The LTC1487 is designed with a  $96\text{k}\Omega$  (typ) input impedance to allow up to 256 transceivers to share a single RS485 differential data bus. The RS485 specification requires that a transceiver be able to drive as many as 32 “unit loads.” One unit load (UL) is defined as an impedance that draws a maximum of 1mA with up to 12V across it. Typical RS485 transceivers present between 0.5 and 1 unit load at their inputs. The  $96\text{k}\Omega$  input impedance of the LTC1487 will draw only  $125\mu\text{A}$  under the same 12V condition, presenting only 0.125UL to the bus. As a result, 256 LTC1487 transceivers ( $32\text{UL}/0.125\text{UL} = 256$ ) can be connected to a single RS485 data bus without exceeding the RS485 driver load specification. The LTC1487 meets all other RS485 specifications, allowing it to operate equally well with standard RS485 transceiver devices or high impedance transceivers.

### CMOS Output Driver

The RS485 specification requires that a transceiver withstand common-mode voltages of up to 12V or  $-7\text{V}$  at the RS485 line connections. Additionally, the transceiver must be immune to both ESD and latch-up. This rules out traditional CMOS drivers, which include parasitic diodes from their driver outputs to each supply rail (Figure 9). The LTC1487 uses a proprietary process enhancement which adds a pair of Schottky diodes to the output stage (Figure 10), preventing current from flowing when the common-mode voltage exceeds the supply rails. Latch-up at the output drivers is virtually eliminated and the driver is prevented from loading the line under RS485 specified fault conditions. A proprietary output protection structure protects the transceiver line terminals against ESD strikes (Human Body Model) of up to  $\pm 10\text{kV}$ .

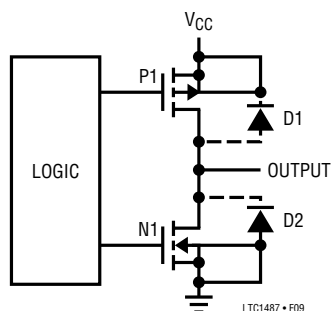

Figure 9. Conventional CMOS Output Stage

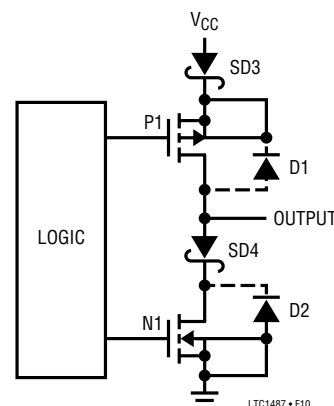

Figure 10. LTC1487 Output Stage

When two or more drivers are connected to the same transmission line, a potential condition exists whereby more than two drivers are simultaneously active. If one or more drivers is sourcing current while another driver is sinking current, excessive power dissipation may occur within either the sourcing or sinking element. This condition is defined as driver contention, since multiple drivers are competing for one transmission line. The LTC1487 provides a current limiting scheme to prevent driver contention failure. When driver contention occurs, the current drawn is limited to about 70mA, preventing excessive power dissipation within the drivers.

The LTC1487 has a thermal shutdown feature which protects the part from excessive power dissipation. Under extreme fault conditions, up to 250mA can flow through the part, causing rapid internal temperature rise. The thermal shutdown circuit will disable the driver outputs when the internal temperature reaches  $150^{\circ}\text{C}$  and turns them back on when the temperature cools to  $130^{\circ}\text{C}$ . This cycle will repeat as necessary until the fault condition is removed.

### Receiver Inputs

The LTC1487 receiver features an input common-mode range covering the entire RS485 specified range of  $-7\text{V}$  to  $12\text{V}$ . Internal  $96\text{k}\Omega$  input resistors from each line terminal to ground provide the 0.125UL load to the RS485 bus. Differential signals of greater than  $\pm 200\text{mV}$  within the specified input common-mode range will be converted to a TTL-compatible signal at the receiver output. A small amount of input hysteresis is included to minimize the

## APPLICATIONS INFORMATION

effects of noise on the line signals. If the line is terminated or the receiver inputs are shorted together, the receiver output will retain the last valid line signal due to the 45mV of hysteresis incorporated in the receiver circuit. If the LTC1487 transceiver inputs are left floating (unterminated), an internal pull-up of 10 $\mu$ A at the A input will force the receiver output to a known high state.

### Low Power Operation

The LTC1487 draws very little supply current whenever the driver outputs are disabled. In shutdown mode, the quiescent current is typically less than 1 $\mu$ A. With the receiver active and the driver outputs disabled, the LTC1487 will typically draw 80 $\mu$ A quiescent current. With the driver outputs enabled but unterminated, quiescent current will rise slightly as one of the two outputs sources current into the internal receiver input resistance. With the minimum receiver input resistance of 70k and the maximum output swing of 5V, the quiescent current will rise by a maximum of 72 $\mu$ A. Typical quiescent current rise with the driver enabled is about 40 $\mu$ A.

The quiescent current rises significantly if the driver is enabled when it is externally terminated. With 1/2 termination load (120 $\Omega$  between the driver outputs), the quiescent current will jump to at least 13mA as the drivers force a minimum of 1.5V across the termination resistance. With a fully terminated 60 $\Omega$  line attached, the current will rise to greater than 25mA with the driver enabled, completely overshadowing the extra 40 $\mu$ A drawn by the internal receiver inputs.

### Shutdown Mode

Both the receiver output (RO) and the driver outputs (A, B) can be placed in three-state mode by bringing  $\overline{RE}$  HIGH and DE LOW respectively. In addition, the LTC1487 will enter shutdown mode when  $\overline{RE}$  is HIGH and DE is LOW.

In shutdown the LTC1487 typically draws only 1 $\mu$ A of supply current. In order to guarantee that the part goes into shutdown,  $\overline{RE}$  must be HIGH and DE must be LOW for at least 600ns simultaneously. If this time duration is less than 50ns the part will not enter shutdown mode. Toggling either  $\overline{RE}$  or DE will wake the LTC1487 back up within 3.5 $\mu$ s.

If the driver is active immediately prior to shutdown, the supply current will not drop to 1 $\mu$ A until the driver outputs have reached a steady state; this can take as long as 2.6 $\mu$ s under worst case conditions. If the driver is disabled prior to shutdown the supply current will drop to 1 $\mu$ A immediately.

### Slew Rate and Propagation Delay

Many digital encoding schemes are dependent upon the difference in the propagation delay times of the driver and receiver. Figure 11 shows the test circuit for the LTC1487 propagation delay.

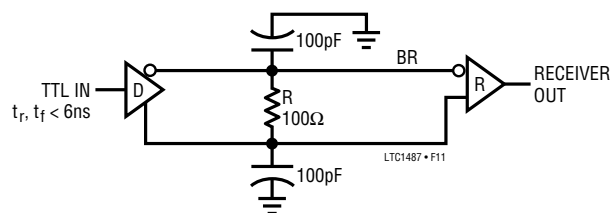

Figure 11. Receiver Propagation Delay Test Circuit

The receiver delay times are:

$$|t_{PLH} - t_{PHL}| = 13\text{ns Typ, } V_{CC} = 5\text{V}$$

The LTC1487 drivers feature controlled slew rate to reduce system EMI and improve signal fidelity by reducing reflections due to misterminated cables.

The driver's skew times are:

$$\text{Skew} = 250\text{ns Typ, } V_{CC} = 5\text{V}$$

$$600\text{ns Max, } V_{CC} = 5\text{V, } T_A = -40^\circ\text{C to } 85^\circ\text{C}$$

## PACKAGE DESCRIPTION

For package descriptions consult the *1994 Linear Databook Volume III*.