

# RL78/G1F CPU Card

R12UZ0014EJ0100

Rev.1.00

## User's Manual

Apr. 5, 2017

### For Your Safety



Do not fail to read this manual before using the RL78/G1F CPU card (RTK0EML240C03000BJ) (the product).

- Follow the indications in this manual when using the product.
- This product is the option board of "24V Motor Control Evaluation System for RX23T (RTK0EM0006S01212BJ)". Please read "Warnings Regarding Use of the Product" of the 24V Motor Control Evaluation System for RX23T User's Manual, and use this product.
- Keep this manual near the product so you can refer to it whenever necessary.
- Transfer or sale of the product to third parties is prohibited without written approval.
- The purchaser or importer of the product is responsible for ensuring compliance with local regulations. In addition, the customer is responsible for ensuring that the product is handled correctly and safely, in accordance with the laws of the customer's country (region).
- All information contained in this manual represents information on products at the time of publication of this manual. Please note that the product data, specification, sales offices, contents of website, address, etc., are subject to change by Renesas Electronics Corporation without notice due to product improvements or other reasons. Please confirm the latest information on Renesas Electronics website.
- The manual for the product, and specification (the documents) are the tool that was developed for the function and performance evaluation of Renesas Electronics semiconductor device (Renesas Electronics device) mounted on the product, and not guarantee the same quality, function and performance.
- By purchasing the product or downloading the documents from Renesas Electronics website, the support services provided from Renesas Electronics is not guaranteed.

### Meaning of Notations

In this manual items related to the safe use of the product are indicated as described below.

The degree of injury to persons or damage to property that could result if the designated content in this manual is not followed is indicated as follows.

 <b>Danger</b>	Indicates content that, if not followed, could result in death or serious injury* <sup>1</sup> to the user, and which is highly urgent.
 <b>Warning</b>	Indicates content that, if not followed, could result in death or serious injury to the user.
 <b>Caution</b>	Indicates content that, if not followed, could result in injury* <sup>2</sup> to persons or physical damage.* <sup>3</sup>

Note 1. Serious injury refers to conditions resulting in persistent after-effects and for which treatment would necessitate hospitalization or regular hospital visits, such as loss or impairment of eyesight, burns (high- or low-temperature), electric shock, bone fracture, or poisoning.

Note 2. Injury refers to conditions for which treatment would necessitate hospitalization or regular hospital visits.

Note 3. Physical damage refers to damage affecting the wider surroundings, such as the user's home or property.

Requirements related to the handling of the product are classified into the following categories.



- Marks indicating that an action is prohibited.

	<p><b>General Prohibition</b> The indicated action is prohibited.</p>		<p><b>Example: Do Not Touch!</b> Touching the specified location could result in injury.</p>
---	---	---	--

- Marks indicating that an action is prohibited.





	<p><b>General Caution</b> Indicates a general need for caution that is not specified.</p>		<p><b>Example: Caution – Hot!</b> Indicates the possibility of injury due to high temperature.</p>
---	---	---	--

- Marks directing that the specified action is required.







	<p><b>General Instruction</b> The specified action is required.</p>		<p><b>Example: Turn Off (Disconnect) Power Supply!</b> Instructs the user to turn off (disconnect) the power supply to the product.</p>
---	---	---	---

## Warnings Regarding Use of the Product





### ■ Danger Items

 <b>Danger</b>	
  	<ul style="list-style-type: none"> <li>• <b>The product should be used only by persons (users) having a thorough knowledge of electrical and mechanical components and systems, a full knowledge of the risks associated with handling them, and training in inverter motor control and handling motors, or equivalent skills. Users should be limited to persons who have carefully read the Caution Items contained in this manual.</b></li> <li>• Unlike typical equipment, the product has no protective case to ensure safety, and it contains moving parts and high-temperature components that could be dangerous. Do not touch the evaluation board or cables while power is being supplied.</li> <li>• Carefully check to make sure that there are no pieces of conductive materials or dust adhering to the board, connectors, and cables.</li> <li>• There are moving parts, driven by a motor. Do not touch the motor while power is being supplied.</li> <li>• Ensure that the motor is insulated and placed in a stable location before supplying power.</li> </ul>
	<p><b>Do Not Connect Load to Motor!</b></p> <ul style="list-style-type: none"> <li>• This could cause fire, burns, or injury.</li> </ul>

■ Warning Items

 <b>Warning</b>	
	<p>Caution – Rotating Parts!</p> <ul style="list-style-type: none"> <li>The system includes a motor. Touching the rotating shaft could cause high-temperature burns or injury.</li> </ul>
	<p>Always insert plugs, connectors, and cables securely, and confirm that they are fully inserted.</p> <ul style="list-style-type: none"> <li>Incomplete connections could cause fire, burns, electric shock, or injury.</li> </ul>
	<p>Use the power supply apparatus specified in the manual.</p> <ul style="list-style-type: none"> <li>Failure to do so could cause fire, burns, electric shock, injury, or malfunction.</li> </ul>
	<p>Disconnect the power supply and unplug all cables when the system will not be used for a period of time or when moving the system.</p> <ul style="list-style-type: none"> <li>Failure to do so could cause fire, burns, electric shock, or malfunction.</li> <li>This will protect the system against damage due to lightning.</li> </ul>
	<p>Use a mechanism (switch, outlet, etc.) located within reach to turn off (disconnect) the power supply.</p> <ul style="list-style-type: none"> <li>In case of emergency, it may be necessary to cut off the power supply quickly.</li> </ul>
	<p>Turn off the power supply immediately if you notice abnormal odor, smoke, abnormal sound, or overheating.</p> <ul style="list-style-type: none"> <li>Continuing to use the system in an abnormal condition could cause fire, burns, or electric shock.</li> </ul>
	<p>Do Not Disassemble, Modify, or Repair!</p> <ul style="list-style-type: none"> <li>Doing so could cause fire, burns, electric shock, injury, or malfunction.</li> </ul>
	<p><b>Do not use the product for any purpose other than initial evaluation of motor control in a testing room or lab. Do not integrate the product or any part of it into other equipment. Do not insert or remove cables or connectors when the product is powered on.</b></p> <ul style="list-style-type: none"> <li>The product has no safety case.</li> <li>Failure to observe the above could cause fire, electric shock, burns, or malfunction.</li> <li>The product may not perform as expected if used for other than its intended purpose.</li> </ul>

■ Caution Items

 <b>Caution</b>	
	<p>Caution – Hot!</p> <ul style="list-style-type: none"> <li>The motor gets hot. Touching it could cause high-temperature burns.</li> </ul>
	<p>Follow the procedure specified in the manual when powering the system on or off.</p> <ul style="list-style-type: none"> <li>Failure to do so could cause overheating or malfunction.</li> </ul>
	<p>Caution – Static Electricity</p> <ul style="list-style-type: none"> <li>Use the antistatic band. Failure to do so could cause malfunction or unstable motion.</li> </ul>

## Overview

The RL78 / G1F CPU card (RTK0EML240C03000BJ) is an optional board for use with the 24V Motor Control Evaluation System for RX23T (RTK0EM0006S01212BJ) (the Motor RSSK). The Motor RSSK comprises a 24V system inverter board (RTK0EM0001B00012BJ) (the INV-BRD) and a RX23T CPU card (RTK0EM0013C01201BJ) (the RX23T-CRD). By replacing the RX23T-CRD with the product, motor evaluation can be performed using the RL78 / G1F.

An EI emulator and equipment related to the Motor RSSK must be provided by the customer.

This user's manual describes the proper handling of the product. Content related to the product is presented in chapters 1 to 4 and 6 to 8. Content related to connection of the INV-BRD supplied with the Motor RSSK is presented in chapter 5. For details of the operation of the INV-BRD, refer to the Motor RSSK user's manual (R20UT3697EJ).

## Target Device

RL78/G1F microcontroller

## Related Documents

- RL78/G1F CPU Card Schematic : R12TU0014EJ
- RL78/G1F CPU Card BOM List : R12TU0015EJ
- RL78/G1F CPU Card PWB Pattern Drawing : R12TU0016EJ
- Renesas Solution Starter Kit  
24V Motor Control Evaluation System for RX23T (Motor RSSK) User's Manual: R20UT3697EJ

## Package Contents

Refer to "RL78/G1F CPU Card Information" and "Caution regarding the Motor Control Evaluation Board

- RL78/G1F CPU Card -" included with this document.

## Abbreviations

Abbreviations	Full Name	Remarks
Motor RSSK	24V Motor Control Evaluation System for RX23T	Motor control evaluation kit for RX23T Product No.: RTK0EM0006S01212BJ
INV-BRD	24V Inverter Board	Inverter board supplied with motor control evaluation kit for RX23T Product No.: RTK0EM0001B00012BJ
RX23T-CRD	RX23T CPU Card	RX23T CPU card supplied with motor control evaluation kit for RX23T Product No.: RTK0EM0013C01201BJ

**Contents**

<b>1. Features</b> .....	<b>6</b>
<b>2. Specifications</b> .....	<b>7</b>
2.1 Specification .....	7
2.2 Regulatory Compliance Notices .....	8
2.2.1 European Union regulatory notices .....	8
<b>3. Block Diagram</b> .....	<b>9</b>
<b>4. Layout</b> .....	<b>10</b>
<b>5. Usage</b> .....	<b>11</b>
5.1 Quick Start .....	11
5.1.1 Preparation .....	11
5.1.2 Replacing the CPU card .....	11
5.1.3 Preparation for Operation Test .....	11
5.1.4 Operation Test .....	11
5.1.5 Finishing the Operation Test .....	11
5.2 Operation .....	12
5.2.1 Basic Operation .....	12
5.2.2 Canceling an Error State .....	12
5.3 In Case of Abnormal Odor, Smoke, Abnormal Sound, Overheating, Etc. ....	12
<b>6. Functions</b> .....	<b>13</b>
6.1 Power Supply .....	13
6.2 Connecting the E1 Emulator .....	13
6.3 Connecting the Inverter Board .....	14
6.4 Connecting the Serial Communication .....	15
6.5 Hall Sensor Signal Input .....	15
6.6 Encoder Signal Input .....	16
6.7 Extension of Unused Pins .....	17
6.8 Reset Circuit .....	17
6.9 Crystal Resonator .....	17
6.10 LEDs .....	18
<b>7. Details of RL78/G1F CPU Card</b> .....	<b>19</b>
7.1 RL78/G1F Features .....	19
7.2 RL78/G1F Pin Assignments .....	20
7.3 List of RL78/G1F Pin Functions .....	21
<b>8. Caution Items</b> .....	<b>22</b>

## 1. Features

1. Populated with RL78/G1F 16-bit microcontroller suitable for inverter control.
2. CPU card designed specifically for use with INV-BRD supplied with Motor RSK.
3. Supports writing of software to flash memory using the E1 emulator.
4. Equipped with Hall sensor input connector and encoder input connector.
5. Equipped with serial communication connector.

## 2. Specifications

### 2.1 Specification

**Table 2.1 Overview of RL78/G1F CPU Card Specifications**

Item	Specification
Product name	RL78/G1F CPU card
Board product No.	RTK0EML240C03000BJ
Supported inverter board / product No.	Supplied with 24V Motor Control Evaluation System for RX23T 24V Inverter Board / RTK0EM0001B00012BJ
Exterior view	

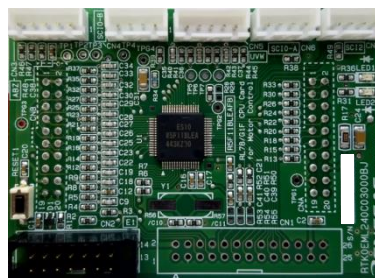

Note: Appearance of actual product may differ from photo.

MCU	Product group	RL78/G1F group
	Product No.	R5F11BLEAFB
	CPU max. operating frequency	32 MHz
	Bit count	16 bits
	Package / Pin count	LFQFP / 64 pins
	ROM	64 KB
	RAM	5.5KB*2
MCU input clock	— ( DNF : does not fit by default ) *3	
Input power supply voltage	DC 5 V ( ± 5% ) Selectable among the following: <ul style="list-style-type: none"> <li>• Power supply from supported inverter board</li> <li>• Power supply from E1*1</li> </ul>	
Supported sensors	Hall sensor, encoder (through holes provided for signal monitoring test pins)	
Supported emulator	E1 emulator	
Connectors	<ul style="list-style-type: none"> <li>• Inverter board connectors × 2</li> <li>• Serial communication connectors × 3</li> <li>• E1 connector</li> <li>• Hall sensor signal input connector</li> <li>• Encoder signal input connector</li> </ul>	
Switch	MCU external reset switch	
LEDs	User control LEDs × 2	
Operating temperature	Room temperature	
Operating humidity	No condensation	

Note 1. Power supply from the E1 emulator is only supported for standalone operation. Power supply from the E1 emulator is not supported when the INV-BRD is connected.

Note 2. This is about 4.5 KB when performing self-programming and rewriting the data flash memory.

Note 3. Mount a crystal oscillator to Y1 of the CPU card when using a crystal oscillator. And, mount C10 and C11 condensers of appropriate capacity instead of R56 and R57.

## 2.2 Regulatory Compliance Notices

### 2.2.1 European Union regulatory notices

This product complies with the following EU Directives. (These directives are only valid in the European Union.)

CE Certifications:

- Electromagnetic Compatibility (EMC) Directive 2014/30/EU  
EN61326-1 : 2013 Class A

---

**WARNING:** This is a Class A product. This equipment can cause radio frequency noise when used in the residential area. In such cases, the user/operator of the equipment may be required to take appropriate countermeasures under his responsibility.

---

- Information for traceability
  - Authorised representative  
Name: Renesas Electronics Corporation  
Address: Toyosu Foresia, 3-2-24, Toyosu, Koto-ku, Tokyo 135-0061, Japan
  - Manufacturer  
Name: Renesas Electronics Corporation  
Address: Toyosu Foresia, 3-2-24, Toyosu, Koto-ku, Tokyo 135-0061, Japan
  - Person responsible for placing on the market  
Name: Renesas Electronics Europe GmbH  
Address: Arcadiastrasse 10, 40472 Dusseldorf, Germany
  - Trademark and Type name  
Trademark: Renesas  
Product name: RL78/G1F CPU Card for Motor Control  
Type name: RTK0EML240C03000BJ

Environmental Compliance and Certifications:

- Waste Electrical and Electronic Equipment (WEEE) Directive 2012/19/EU



3. Block Diagram

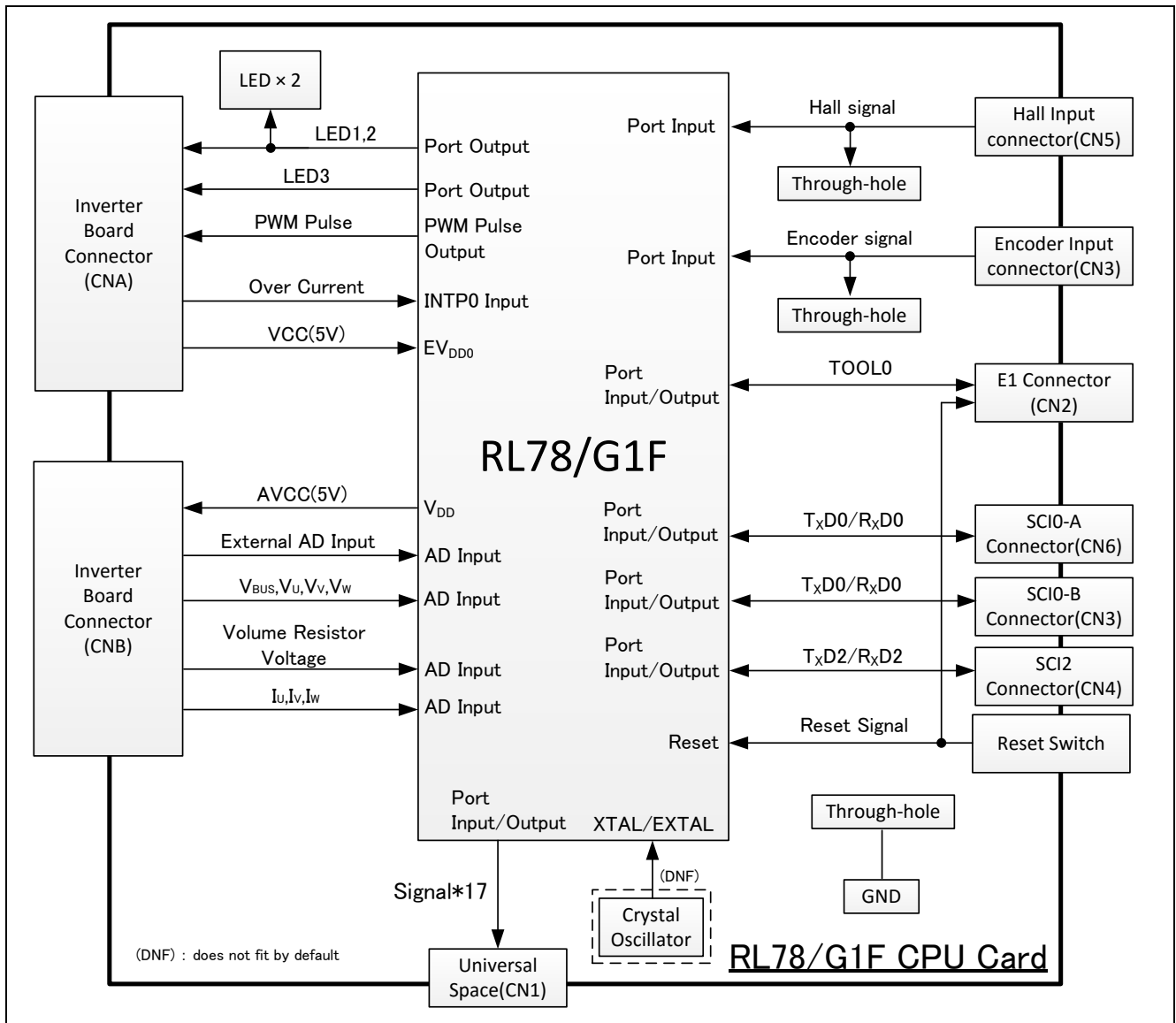

Figure 3.1 RL78/G1F CPU Card Block Diagram

4. Layout

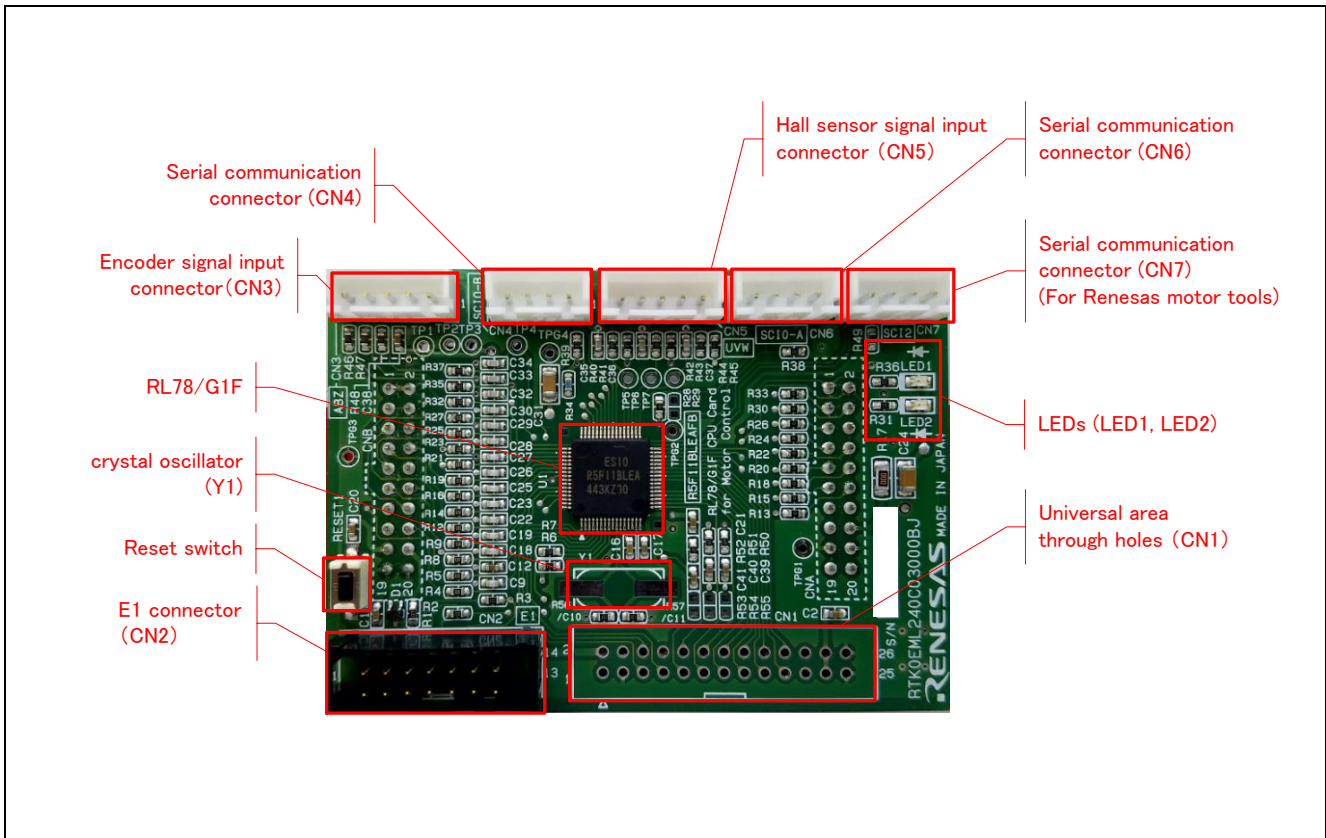

Figure 4.1 RL78/G1F CPU Card Layout (Top View)

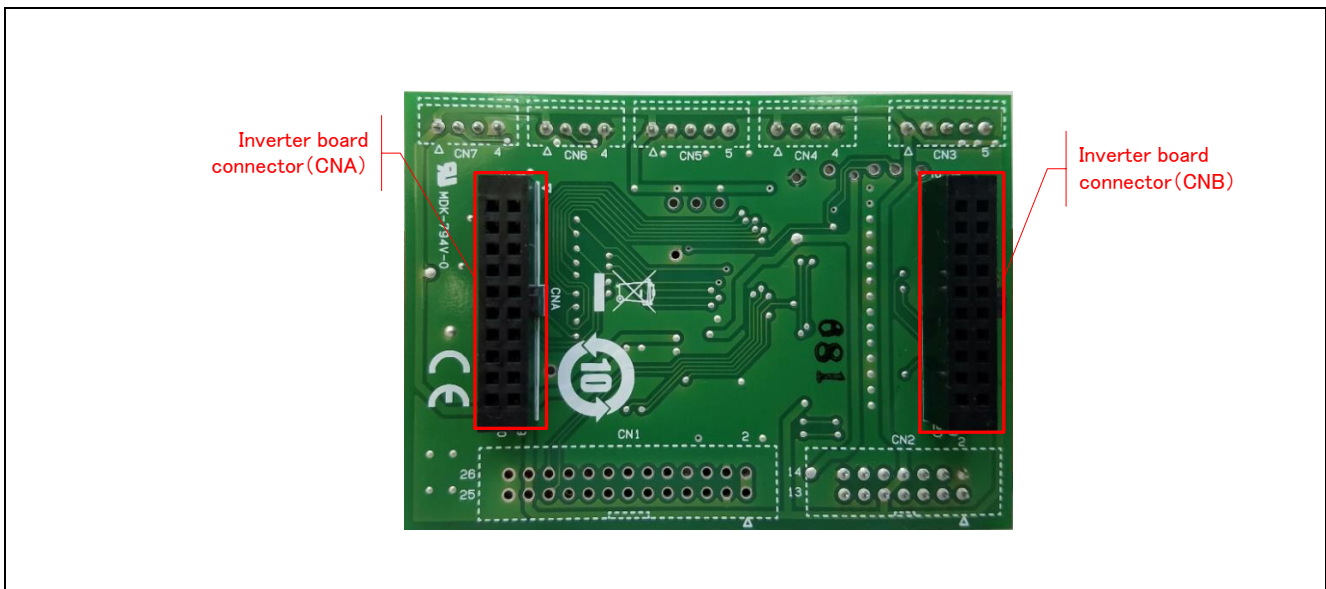

Figure 4.2 RL78/G1F CPU Card Layout (Bottom View)

## 5. Usage

### 5.1 Quick Start

#### 5.1.1 Preparation

Obtain the Motor RSSK, and perform the steps described in 5.1.1 and 5.1.2, Quick Start, of the user's manual (R20UT3697EJ).

#### 5.1.2 Replacing the CPU card

Confirm that the INV-BRD is powered off, remove the RX23T-CRD from the INV-BRD, and connect the product in its place.

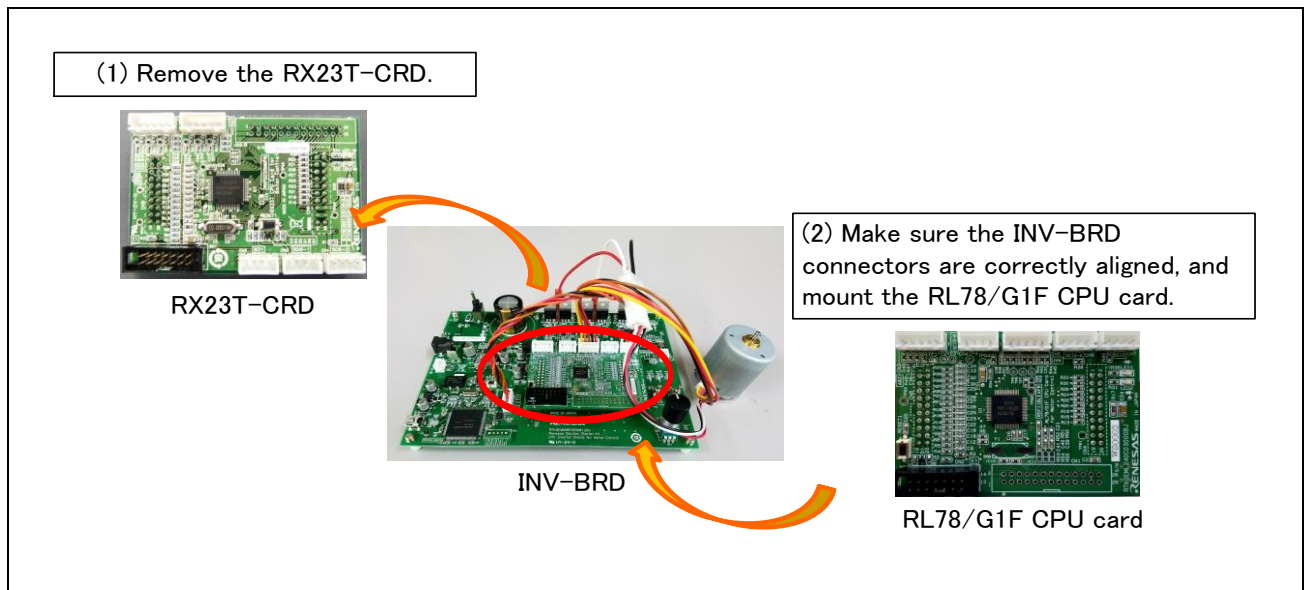

Figure 5.1 CPU card replacement

#### 5.1.3 Preparation for Operation Test

Perform the steps described in 5.1.3 to 5.1.5 of the Motor RSSK user's manual (R20UT3697EJ) to prepare for motor drive.

#### 5.1.4 Operation Test

Perform the steps described in 5.1.6 to 5.1.9 of the Motor RSSK user's manual (R20UT3697EJ) in the order indicated, turn on the power supply, enable motor rotation, change the motor rotation speed, and stop motor rotation.

#### 5.1.5 Finishing the Operation Test

After the operation test is finished, confirm that the motor shaft is no longer rotating and turn off the stabilized power supply output.

## 5.2 Operation

### 5.2.1 Basic Operation

Out of the box the product is programmed with hall 120-degree conducting control software for the RL78/G1F. Table 5.1 lists the software specifications and the basic operations when connected to the INV-BRD.

**Table 5.1 Initial Software Specifications**

Item	Specification
Control method	Hall 120-degree conducting control
VR1	Clockwise turn: Motor shaft rotates clockwise. Counterclockwise turn: Motor shaft rotates counterclockwise.
SW1	ON: Motor rotation enabled OFF: Motor rotation disabled
SW2	Cancels error state: OFF → ON → OFF after an error:
LED1	ON: SW1 ON and normal state. OFF: SW1 OFF or error state.
LED2	ON: error state. OFF: normal state.

### 5.2.2 Canceling an Error State

If an error occurs, LED2 lights on the INV-BRD and the product, and motor rotation stops. To recover, it is necessary to turn off toggle switch SW1 and turn on toggle switch SW2 on the INV-BRD, and then turn off toggle switch SW2 again.

## 5.3 In Case of Abnormal Odor, Smoke, Abnormal Sound, Overheating, Etc.

The INV-BRD is equipped with a toggle switch (S1) to cut off the flow of current to the inverter. If an abnormal condition (such as abnormal odor, smoke, abnormal sound, or overheating) occurs, turn off S1 to cut off current flow to the inverter.

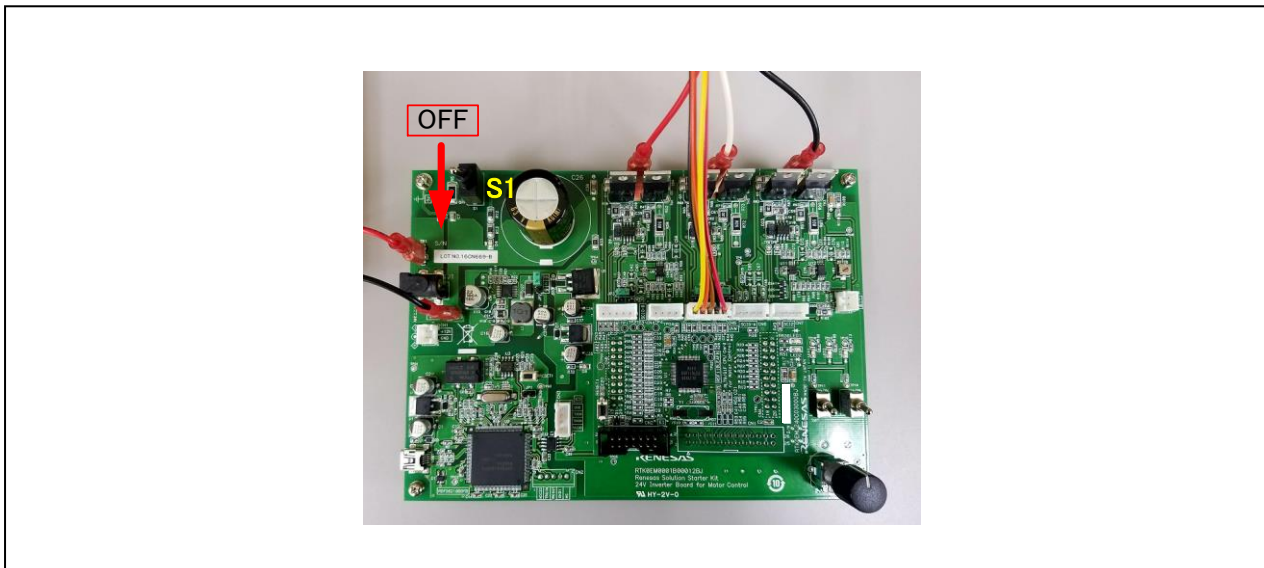

**Figure 5.2 Cut off current**

## 6. Functions

### 6.1 Power Supply

The product does not have a dedicated power supply connector. When connected to the INV-BRD it draws power via the connector. When not connected to the INV-BRD, it can draw power via the E1 connector. The product is not allowed to draw power via the E1 connector when it is connected to the INV-BRD.

### 6.2 Connecting the E1 Emulator

The E1 on-chip debugging emulator from Renesas Electronics is used to write software (program) to the flash memory of the RL78/G1F. Software will be downloaded into the product via E1 emulator. It is also necessary to make the settings shown in Table 6.1 in the integrated development environment to enable the emulator to supply power to the product. Table 6.2 lists the pin assignments of the E1 connector.

**Table 6.1 E1 Emulator Power Supply Settings**

Connection to INV-BRD	Power Supply Setting of E1 Emulator
Connected	Power supply not allowed*1
Not connected	5 V power supply

Note 1. When connected to the INV-BRD, the product must draw power from the INV-BRD.

**Table 6.2 Pin Assignments of E1 Connector (CN2)**

Pin No.	Pin Function	RL78/G1F Connection Pins	Pin No.	Pin Function	RL78/G1F Connection Pins
1	NC	—	2	GND	EV <sub>SS0</sub> /V <sub>SS</sub>
3	NC	—	4	NC	
5	TOOL0	TOOL0	6	RESET_IN	$\overline{\text{RESET}}$
7	NC	—	8	VDD	EV <sub>DD0</sub> /V <sub>DD</sub>
9	EMVDD	EV <sub>DD0</sub>	10	RESET_OUT	$\overline{\text{RESET}}$
11	NC	—	12	GND	EV <sub>SS0</sub> /V <sub>SS</sub>
13	RESET_OUT	$\overline{\text{RESET}}$	14	GND	EV <sub>SS0</sub> /V <sub>SS</sub>

Note: See a supplement to the E1/E20 emulator user's manual (RL78 connection Guidelines).

### 6.3 Connecting the Inverter Board

The product connects to the INV-BRD via the inverter board connectors (CNA and CNB). Table 6.3 and Table 6.4 list the pin assignments of the inverter board connectors.

**Table 6.3 Pin Assignments of Inverter Board Connector (CNA)**

Pin No.	Pin Function	RL78/G1F Connection Pins	Pin No.	Pin Function	RL78/G1F Connection Pins
1	LED1#	P141	2	LED2#	P140
3	PFC_G1#	P04	4	VRL	P55
5	FO#	P55/INTP4	6	NC	—
7	WN1	P10/TRDIOD1	8	VN1	P11/TRDIOC1
9	UN1	P14/TRDIOD0	10	WP1	P12/TRDIOB1
11	VP1	P13/TRDIOA1	12	UP1	P15/TRDIOB0
13	SW1#	P05	14	SW2#	P06
15	5V	EV <sub>DD</sub>	16	5V	EV <sub>DD</sub>
17	GND	EV <sub>SS0</sub>	18	GND	EV <sub>SS0</sub>
19	3.3V	—	20	3.3V	—

**Table 6.4 Pin Assignments of Inverter Board Connector (CNB)**

Pin No.	Pin Function	RL78/G1F Connection Pins	Pin No.	Pin Function	RL78/G1F Connection Pins
1	AVCC	V <sub>DD</sub>	2	AVCC	V <sub>DD</sub>
3	NC	—	4	NC	—
5	IU1	P22/ANI2	6	IV1	P120/ANI19
7	IW1	P23/ANI3	8	VPN	P24/ANI4
9	TEMP1	P27/ANI7	10	VU1	P03/ANI16
11	VV1	P20/ANI0	12	VW1	P21/ANI1
13	VAC	P25/ANI5	14	IPFC	P147/ANI18
15	VR1	P26/ANI6	16	RSVIN1	P02/ANI17
17	VCCIO	EV <sub>DD0</sub>	18	VCCIO	EV <sub>DD0</sub>
19	GND	V <sub>SS</sub>	20	GND	V <sub>SS</sub>

## 6.4 Connecting the Serial Communication

The product communicates with the UART via the serial communication connectors. There are three serial communication connectors: CN4, CN6, and CN7. Table 6.5 lists their pin assignments. Use CN7 when using a tool such as waveform display in conjunction with the INV-BRD.

**Table 6.5 Pin Assignments of Serial Communication Connectors (CN4, CN6, CN7)**

Connector No.	Pin No.	Pin Function	RXL78/G1F Connection Pins
CN4 SCI0-1	1	5V	EV <sub>DD0</sub>
	2	RL78/G1F transmit side	P17/TxD0 <sup>*1</sup>
	3	RL78/G1F receive side	P16/RxD0 <sup>*1</sup>
	4	GND	EV <sub>SS0</sub>
CN6 SCI0-2	1	5V	EV <sub>DD0</sub>
	2	RL78/G1F transmit side	P51/TxD0
	3	RL78/G1F receive side	P50/RxD0 <sup>*2</sup>
	4	GND	EV <sub>SS0</sub>
CN7 SCI2	1	5V	EV <sub>DD0</sub>
	2	RL78/G1F transmit side	P77/TxD2 <sup>*1</sup>
	3	RL78/G1F receive side	P76/RxD2 <sup>*1</sup>
	4	GND	EV <sub>SS0</sub>

Note 1. If you want to use this function, please be set to 1 PIOR01 bit of PIOR0 register.

Note 2. This port is, because of the Z-phase (ENC-Z) function and shared, can't be used in the factory state.

## 6.5 Hall Sensor Signal Input

The product is equipped with a Hall sensor signal input connector. Using this connector it is possible to input the Hall sensor signal from the motor supplied with the Motor RSSK directly to the product. The signal input to the product is pulled up to 5 V and passed through an RC filter before being input to the RL78/G1F. Table 6.6 lists the pin assignments of the Hall sensor signal input connector, and Table 6.7 lists connector information.

**Table 6.6 Pin Assignments of Hall Sensor Signal Input Connector (CN5)**

Pin No.	Pin Function	RL78/G1F Connection Pins
1	5V	EV <sub>DD0</sub>
2	GND	EV <sub>SS0</sub>
3	HU	P52 (INTP1)
4	HV	P53 (INTP2)
5	HW	P54 (INTP3)

**Table 6.7 Hall Sensor Signal Input Connector Information**

Part	Product No.	Manufacturer
Connector (CN5)	B5B-XH-A	J.S.T. Mfg. Co. Ltd.

## 6.6 Encoder Signal Input

The product is equipped with an encoder signal input connector. This makes it possible to input the encoder signal to the RL78/G1F. The signal input to the product is pulled up to 5 V and passed through an RC filter before being input to the RL78/G1F. Table 6.8 lists the pin assignments of the signal input connector, and Table 6.9 lists connector information.

**Table 6.8 Pin Assignments of Encoder Signal Input Connector (CN3)**

Pin No.	Pin Function	RL78/G1F Connection Pins
1	5V	EV <sub>DD0</sub>
2	GND	EV <sub>SS0</sub>
3	A-phase	P00/TRGCLKA
4	B-phase	P01/TRGCLKB
5	Z-phase	P50

**Table 6.9 Encoder Signal Input Connector Information**

Part	Product No.	Manufacturer
Connector (CN3)	B5B-XH-A	J.S.T. Mfg. Co. Ltd.



## 6.7 Extension of Unused Pins

To facilitate general use of the product, the unused pins of the RL78/G1F are extended through universal area through holes in the board. Table 6.10 lists the pin assignments of the universal area through holes.

**Table 6.10 Pin Assignments of Universal Area Through Holes (CN1)**

Pin No.	RL78/G1F Connection Pins	Pin No.	RL78/G1F Connection Pins
1	V <sub>DD</sub>	2	V <sub>DD</sub>
3	EV <sub>SS0</sub>	4	EV <sub>SS0</sub>
5	P43	6	P42
7	P41	8	NC
9	P60 <sup>*1</sup>	10	P61 <sup>*1</sup>
11	P62 <sup>*1</sup>	12	P63
13	P31	14	P75
15	P74	16	P73
17	P72	18	P71
19	P70	20	P30
21	P147	22	P130
23	EV <sub>DD0</sub>	24	EV <sub>DD0</sub>
25	EV <sub>SS0</sub>	26	EV <sub>SS0</sub>

Note 1. P60 to P62 is separated from through-holes by unmounted 0 ohm resistors as a factory default.

## 6.8 Reset Circuit

The product is equipped with a reset circuit for resetting the MCU at power-on reset and external reset. To apply an external reset to the MCU, press the pushbutton (RESET1).

## 6.9 Crystal Resonator

A crystal oscillator (Y1) is not mounted on this product board as a factory default.

Considering treatment of unused pin, registers (R56, R57) are mounted instead of crystal load condensers (C10, C11).

If you use a crystal oscillator (Y1), connect a crystal oscillator (1-20MHz) to X2/X1 pin of MCU on the board.

HC-49/US SMD type is need when mounting.

Depending on the wiring and X2/X1 pin of MCU capacitance, mount an appropriate load condensers as C10 and C11 instead of R56 and R57.

## 6.10 LEDs

Two LEDs are mounted on the product for use in debugging programs and general system applications. Each turns on when the output on the corresponding port is low-level and turns off when the output is high-level. Table 6.11 lists the pin assignments corresponding to the LEDs.

**Table 6.11 RL78/G1F CPU Card LED Connection Pin Assignments**

Corresponding RL78/G1F Port		LED1	LED2
P141	High-level output	Off	—
	Low-level output	On	—
P140	High-level output	—	Off
	Low-level output	—	On

## 7. Details of RL78/G1F CPU Card

### 7.1 RL78/G1F Features

- The microcontroller which incorporated the RL78 CPU core, 16-bit CISC, and high-performance (max 32MHz)
- 3-phase motor control PWM output timer: 16-bit Timer RD (max 64MHz)
- 2-phase encoder timer: 16-bit Timer RG
- Overcurrent detection and PWM output forced shutdown functions
  - The high-speed Programmable Gain Amplifier for the amplification: PGA
  - The high-speed comparator for Overcurrent detection: CMP0
  - The output forced shutdown function: PWMOPA
- Sensorless 120-degree conducting control for the brushless DC motor
  - 4-input selection high-speed comparator: CMP1
  - 64 MHz operable input capture timer for motor control: Timer RX (max 64MHz)
- 10-bit resolution A/D converter (17 channels)
- 8-bit resolution D/A converter (output, 2 channels)

## 7.2 RL78/G1F Pin Assignments

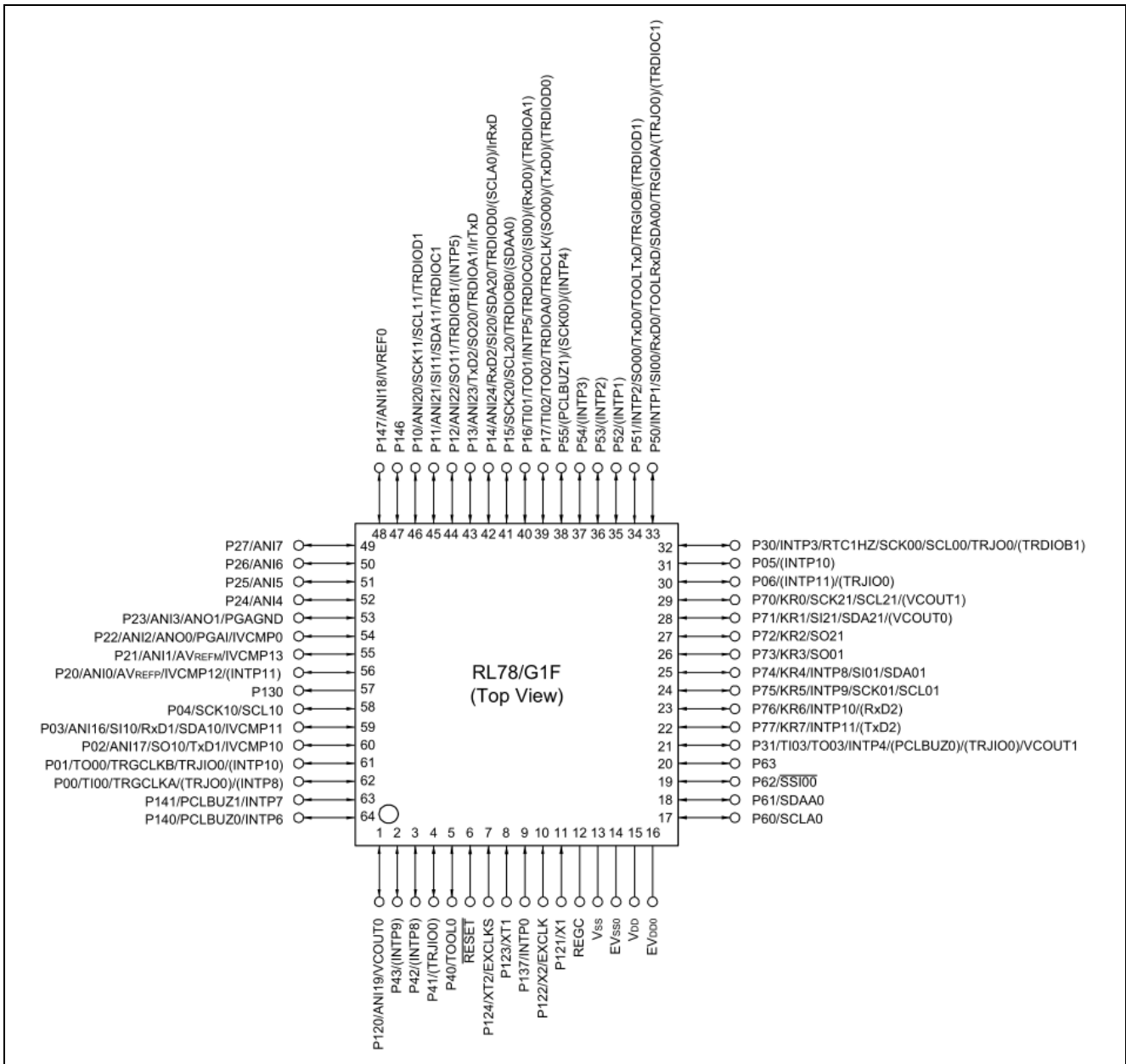

Figure 7.1 RL78/G1F Pin Assignments

### 7.3 List of RL78/G1F Pin Functions

Table 7.1 List of RL78/G1F Pin Functions

Pin No.	RL78/G1F Pin Functions	CPU Card Connection	INV-BRD Connection (N.C.: No connected)
1	P120/ANI19/VCOU0	CNB-6 pin	V-phase current detection
2	P43/(INTP9)	CN1-5 pin	N.C.
3	P42/(INTP8)	CN1-6 pin	N.C.
4	P41/(TRJIO0)	CN1-7 pin	N.C.
5	P40/TOOL0	CN2-5 pin	N.C.
6	RESET	Reset	N.C.
7	P124/XT2/EXCLKS	Pull-up	N.C.
8	P123/XT1	Pull-up	N.C.
9	P137/INTP0	CNA-5 pin	Overcurrent detection
10	P122/X2/EXCLK	Pull-down	N.C.
11	P121/X1	Pull-down	N.C.
12	REGC	GND	GND
13	V <sub>SS</sub>	GND	GND
14	EV <sub>SS0</sub>	GND	GND
15	V <sub>DD</sub>	AVCC	AVCC
16	EV <sub>DD0</sub>	AVCC	AVCC
17	P60/SCLA0	CN1-9 pin <sup>*1</sup>	N.C.
18	P61/SDAA0	CN1-10 pin <sup>*1</sup>	N.C.
19	P62/SSI00	CN1-11 pin <sup>*1</sup>	N.C.
20	P63	CN1-12 pin	N.C.
21	P31/TI03/TO03/INTP4/(PCLBUZ0)/(TRJIO0)/VC OUT1	CN1-13 pin	N.C.
22	P77/KR7/INTP11/(T <sub>x</sub> D2)	CN7-2 pin	Communication port
23	P76/KR6/INTP10/(R <sub>x</sub> D2)	CN7-3 pin	Communication port
24	P75/KR5/INTP9/SCK01/SCL01	CN1-14 pin	N.C.
25	P74/KR4/INTP8/SI01/SDA01	CN1-15 pin	N.C.
26	P73/KR3/SO01	CN1-16 pin	N.C.
27	P72/KR2/SO21	CN1-17 pin	N.C.
28	P71/KR1/SI21/SDA21/(VCOU0)	CN1-18 pin	N.C.
29	P70/KR0/SCK21/SCL21/(VCOU1)	CN1-19 pin	N.C.
30	P06/(INTP11)/(TRJIO0)	CNA-14 pin	Toggle switch (SW2)
31	P05/(INTP10)	CNA-13 pin	Toggle switch (SW1)
32	P30/INTP3/RTC1HZ/SCK00/SCL00/TRJO0/(TR DIOB1)	CN1-20 pin	N.C.
33	P50/INTP1/SI00/R <sub>x</sub> D0/TOOLR <sub>x</sub> D/SDA00/TRGIO A/(TRJO0)/(TRDIOC1)	CN3-5 pin	Encoder (Z-phase )
34	P51/INTP2/SO00/T <sub>x</sub> D0/TOOLT <sub>x</sub> D/TRGIOB/(TRD IOD1)	CN6-2 pin	N.C.
35	P52/(INTP1)	CN5-3 pin	Hall sensor (U)
36	P53/(INTP2)	CN5-4 pin	Hall sensor (V)

Note 1. P60 to P62 is separated from through-holes by unmounted 0 ohm resistors as a factory default.

Pin No.	RL78/G1F Pin Functions	CPU Card Connection	INV-BRD Connection (N.C.: No connected)
37	P54/(INTP3)	CN5-5 pin	Hall sensor (W)
38	P55/(PCLBUZ1)/(SCK00)/(INTP4)	CNA-4 pin	N.C.
39	P17/TI02/TO02/TRDIOA0/TRDCLK/(SO00)/(TXD0)/(TRDIOD0)	CN4-2 pin	N.C.
40	P16/TI01/TO01/INTP5/TRDIOC0/(SI00)/(RxD0)/(TRDIOA1)	CN4-3 pin	N.C.
41	P15/SCK20/SCL20/TRDIOB0/(SDAA0)	CNA-12 pin	U+phase PWM input
42	P14/ANI24/RXD2/SI20/SDA20/TRDIOD0/(SCLA0)/IrxD	CNA-9 pin	U-phase PWM input
43	P13/ANI23/TXD2/SO20/TRDIOA1/IrTxD	CNA-11 pin	V+phase PWM input
44	P12/ANI22/SO11/TRDIOB1/(INTP5)	CNA-10 pin	W+phase PWM input
45	P11/ANI21/SI11/SDA11/TRDIOC1	CNA-8 pin	V-phase PWM input
46	P10/ANI20/SCK11/SCL11/TRDIOD1	CNA-7 pin	W-phase PWM input
47	P146	CN1-21 pin	N.C.
48	P147/ANI18/VREF0	CNB-14 pin	N.C.
49	P27/ANI7	CNB-9 pin	External A/D input
50	P26/ANI6	CNB-15 pin	VR/switch voltage detection
51	P25/ANI5	CNB-13 pin	N.C.
52	P24/ANI4	CNB-8 pin	Bus line voltage detection
53	P23/ANI3/ANO1/PGAGND	CNB-7 pin	W-phase current detection
54	P22/ANI2/ANO0/PGAI/IVCMP0	CNB-5 pin	U-phase current detection
55	P21/ANI1/AVREFM/IVCMP13	CNB-12 pin	W-phase voltage detection
56	P20/ANI0/AVREFP/IVCMP12/(INTP11)	CNB-11 pin	V-phase voltage detection
57	P130	CN1-22 pin	N.C.
58	P04/SCK10/SCL10	CNA-3 pin	LED3
59	P03/ANI16/SI10/RxD1/SDA10/IVCMP11	CNB-10 pin	U-phase voltage detection
60	P02/ANI17/SO10/TxD1/IVCMP10	CNB-16 pin	N.C.
61	P01/TO00/TRGCLKB/TRJIO0/(INTP10)	CN3-4 pin	Encoder (B-phase )
62	P00/TI00/TRGCLKA/(TRJO0)/(INTP8)	CN3-3 pin	Encoder (A-phase )
63	P141/PCLBUZ1/INTP7	CNA-1 pin	LED1
64	P140/PCLBUZ0/INTP6	CNA-2 pin	LED2

## 8. Caution Items

Caution items related to use of the product are as follows.

The product includes some unused pins that have not been processed. For information on accurate pin processing, refer to the hardware manual of the microcontroller.

**Website and Support**

Renesas Electronics Website

<http://www.renesas.com/>

Inquiries

<http://www.renesas.com/contact/>

All trademarks and registered trademarks are the property of their respective owners.

## Revision History

Rev.	Date	Description	
		Page	Summary
1.00	Apr. 5, 2017	—	First edition issued



## General Precautions in the Handling of Microprocessing Unit and Microcontroller Unit Products

The following usage notes are applicable to all Microprocessing unit and Microcontroller unit products from Renesas. For detailed usage notes on the products covered by this document, refer to the relevant sections of the document as well as any technical updates that have been issued for the products.

### 1. Handling of Unused Pins

Handle unused pins in accordance with the directions given under Handling of Unused Pins in the manual.

¾ The input pins of CMOS products are generally in the high-impedance state. In operation with an unused pin in the open-circuit state, extra electromagnetic noise is induced in the vicinity of LSI, an associated shoot-through current flows internally, and malfunctions occur due to the false recognition of the pin state as an input signal become possible. Unused pins should be handled as described under Handling of Unused Pins in the manual.

### 2. Processing at Power-on

The state of the product is undefined at the moment when power is supplied.

¾ The states of internal circuits in the LSI are indeterminate and the states of register settings and pins are undefined at the moment when power is supplied.

In a finished product where the reset signal is applied to the external reset pin, the states of pins are not guaranteed from the moment when power is supplied until the reset process is completed. In a similar way, the states of pins in a product that is reset by an on-chip power-on reset function are not guaranteed from the moment when power is supplied until the power reaches the level at which resetting has been specified.

### 3. Prohibition of Access to Reserved Addresses

Access to reserved addresses is prohibited.

¾ The reserved addresses are provided for the possible future expansion of functions. Do not access these addresses; the correct operation of LSI is not guaranteed if they are accessed.

### 4. Clock Signals

After applying a reset, only release the reset line after the operating clock signal has become stable. When switching the clock signal during program execution, wait until the target clock signal has stabilized.

¾ When the clock signal is generated with an external resonator (or from an external oscillator) during a reset, ensure that the reset line is only released after full stabilization of the clock signal. Moreover, when switching to a clock signal produced with an external resonator (or by an external oscillator) while program execution is in progress, wait until the target clock signal is stable.

### 5. Differences between Products

Before changing from one product to another, i.e. to a product with a different part number, confirm that the change will not lead to problems.

¾ The characteristics of Microprocessing unit or Microcontroller unit products in the same group but having a different part number may differ in terms of the internal memory capacity, layout pattern, and other factors, which can affect the ranges of electrical characteristics, such as characteristic values, operating margins, immunity to noise, and amount of radiated noise. When changing to a product with a different part number, implement a system-evaluation test for the given product.

## Notice

1. Descriptions of circuits, software and other related information in this document are provided only to illustrate the operation of semiconductor products and application examples. You are fully responsible for the incorporation or any other use of the circuits, software, and information in the design of your product or system. Renesas Electronics disclaims any and all liability for any losses and damages incurred by you or third parties arising from the use of these circuits, software, or information.
2. Renesas Electronics hereby expressly disclaims any warranties against and liability for infringement or any other disputes involving patents, copyrights, or other intellectual property rights of third parties, by or arising from the use of Renesas Electronics products or technical information described in this document, including but not limited to, the product data, drawing, chart, program, algorithm, application examples.
3. No license, express, implied or otherwise, is granted hereby under any patents, copyrights or other intellectual property rights of Renesas Electronics or others.
4. You shall not alter, modify, copy, or otherwise misappropriate any Renesas Electronics product, whether in whole or in part. Renesas Electronics disclaims any and all liability for any losses or damages incurred by you or third parties arising from such alteration, modification, copy or otherwise misappropriation of Renesas Electronics products.
5. Renesas Electronics products are classified according to the following two quality grades: "Standard" and "High Quality". The intended applications for each Renesas Electronics product depends on the product's quality grade, as indicated below.  
"Standard": Computers; office equipment; communications equipment; test and measurement equipment; audio and visual equipment; home electronic appliances; machine tools; personal electronic equipment; and industrial robots etc.  
"High Quality": Transportation equipment (automobiles, trains, ships, etc.); traffic control (traffic lights); large-scale communication equipment; key financial terminal systems; safety control equipment; etc.  
Renesas Electronics products are neither intended nor authorized for use in products or systems that may pose a direct threat to human life or bodily injury (artificial life support devices or systems, surgical implantations etc.), or may cause serious property damages (space and undersea repeaters; nuclear power control systems; aircraft control systems; key plant systems; military equipment; etc.). Renesas Electronics disclaims any and all liability for any damages or losses incurred by you or third parties arising from the use of any Renesas Electronics product for which the product is not intended by Renesas Electronics.
6. When using the Renesas Electronics products, refer to the latest product information (data sheets, user's manuals, application notes, "General Notes for Handling and Using Semiconductor Devices" in the reliability handbook, etc.), and ensure that usage conditions are within the ranges specified by Renesas Electronics with respect to maximum ratings, operating power supply voltage range, heat radiation characteristics, installation, etc. Renesas Electronics disclaims any and all liability for any malfunctions or failure or accident arising out of the use of Renesas Electronics products beyond such specified ranges.
7. Although Renesas Electronics endeavors to improve the quality and reliability of Renesas Electronics products, semiconductor products have specific characteristics such as the occurrence of failure at a certain rate and malfunctions under certain use conditions. Further, Renesas Electronics products are not subject to radiation resistance design. Please ensure to implement safety measures to guard them against the possibility of bodily injury, injury or damage caused by fire, and social damage in the event of failure or malfunction of Renesas Electronics products, such as safety design for hardware and software including but not limited to redundancy, fire control and malfunction prevention, appropriate treatment for aging degradation or any other appropriate measures by your own responsibility as warranty for your products/system. Because the evaluation of microcomputer software alone is very difficult and not practical, please evaluate the safety of the final products or systems manufactured by you.
8. Please contact a Renesas Electronics sales office for details as to environmental matters such as the environmental compatibility of each Renesas Electronics product. Please investigate applicable laws and regulations that regulate the inclusion or use of controlled substances, including without limitation, the EU RoHS Directive carefully and sufficiently and use Renesas Electronics products in compliance with all these applicable laws and regulations. Renesas Electronics disclaims any and all liability for damages or losses occurring as a result of your noncompliance with applicable laws and regulations.
9. Renesas Electronics products and technologies shall not be used for or incorporated into any products or systems whose manufacture, use, or sale is prohibited under any applicable domestic or foreign laws or regulations. You shall not use Renesas Electronics products or technologies for (1) any purpose relating to the development, design, manufacture, use, stockpiling, etc., of weapons of mass destruction, such as nuclear weapons, chemical weapons, or biological weapons, or missiles (including unmanned aerial vehicles (UAVs)) for delivering such weapons, (2) any purpose relating to the development, design, manufacture, or use of conventional weapons, or (3) any other purpose of disturbing international peace and security, and you shall not sell, export, lease, transfer, or release Renesas Electronics products or technologies to any third party whether directly or indirectly with knowledge or reason to know that the third party or any other party will engage in the activities described above. When exporting, selling, transferring, etc., Renesas Electronics products or technologies, you shall comply with any applicable export control laws and regulations promulgated and administered by the governments of the countries asserting jurisdiction over the parties or transactions.
10. Please acknowledge and agree that you shall bear all the losses and damages which are incurred from the misuse or violation of the terms and conditions described in this document, including this notice, and hold Renesas Electronics harmless, if such misuse or violation results from your resale or making Renesas Electronics products available any third party.
11. This document shall not be reprinted, reproduced or duplicated in any form, in whole or in part, without prior written consent of Renesas Electronics.
12. Please contact a Renesas Electronics sales office if you have any questions regarding the information contained in this document or Renesas Electronics products.  
(Note 1) "Renesas Electronics" as used in this document means Renesas Electronics Corporation and also includes its majority-owned subsidiaries.  
(Note 2) "Renesas Electronics product(s)" means any product developed or manufactured by or for Renesas Electronics.

(Rev.3.0-1 November 2016)



### SALES OFFICES

Renesas Electronics Corporation

<http://www.renesas.com>

Refer to "<http://www.renesas.com/>" for the latest and detailed information.

#### Renesas Electronics America Inc.

2801 Scott Boulevard Santa Clara, CA 95050-2549, U.S.A.  
Tel: +1-408-588-6000, Fax: +1-408-588-6130

#### Renesas Electronics Canada Limited

9251 Yonge Street, Suite 8309 Richmond Hill, Ontario Canada L4C 9T3  
Tel: +1-905-237-2004

#### Renesas Electronics Europe Limited

Dukes Meadow, Millboard Road, Bourne End, Buckinghamshire, SL8 5FH, U.K.  
Tel: +44-1628-585-100, Fax: +44-1628-585-900

#### Renesas Electronics Europe GmbH

Arcadiastrasse 10, 40472 Düsseldorf, Germany  
Tel: +49-211-6503-0, Fax: +49-211-6503-1327

#### Renesas Electronics (China) Co., Ltd.

Room 1709, Quantum Plaza, No.27 ZhiChunLu Haidian District, Beijing 100191, P.R.China  
Tel: +86-10-8235-1155, Fax: +86-10-8235-7679

#### Renesas Electronics (Shanghai) Co., Ltd.

Unit 301, Tower A, Central Towers, 555 Langao Road, Putuo District, Shanghai, P. R. China 200333  
Tel: +86-21-2226-0888, Fax: +86-21-2226-0999

#### Renesas Electronics Hong Kong Limited

Unit 1601-1611, 16/F., Tower 2, Grand Century Place, 193 Prince Edward Road West, Mongkok, Kowloon, Hong Kong  
Tel: +852-2265-6688, Fax: +852-2886-9022

#### Renesas Electronics Taiwan Co., Ltd.

13F, No. 363, Fu Shing North Road, Taipei 10543, Taiwan  
Tel: +886-2-8175-9600, Fax: +886-2-8175-9670

#### Renesas Electronics Singapore Pte. Ltd.

80 Bendemeer Road, Unit #06-02 Hyflux Innovation Centre, Singapore 339949  
Tel: +65-6213-0200, Fax: +65-6213-0300

#### Renesas Electronics Malaysia Sdn.Bhd.

Unit 1207, Block B, Menara Amcorp, Amcorp Trade Centre, No. 18, Jln Persiaran Barat, 46050 Petaling Jaya, Selangor Darul Ehsan, Malaysia  
Tel: +60-3-7955-9390, Fax: +60-3-7955-9510

#### Renesas Electronics India Pvt. Ltd.

No.777C, 100 Feet Road, HAL II Stage, Indiranagar, Bangalore, India  
Tel: +91-80-67208700, Fax: +91-80-67208777

#### Renesas Electronics Korea Co., Ltd.

12F., 234 Teheran-ro, Gangnam-Gu, Seoul, 135-080, Korea  
Tel: +82-2-558-3737, Fax: +82-2-558-5141

# Mouser Electronics

Authorized Distributor

Click to View Pricing, Inventory, Delivery & Lifecycle Information:

[Renesas Electronics:](#)

[RTK0EML240C03000BJ](#)