

## MMBT5551-G (NPN) RoHS Device

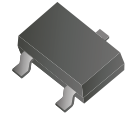

### Features

- Epitaxial planar die construction.
- Complementary PNP type available (MMBT5401-G).
- Ideal for medium power amplification and switching.

### Mechanical data

- Case: SOT-23, molded plastic.
- Terminals: Solderable per MIL-STD-750, method 2026.
- Approx. weight: 0.008 grams(approx.).

### Circuit Diagram:

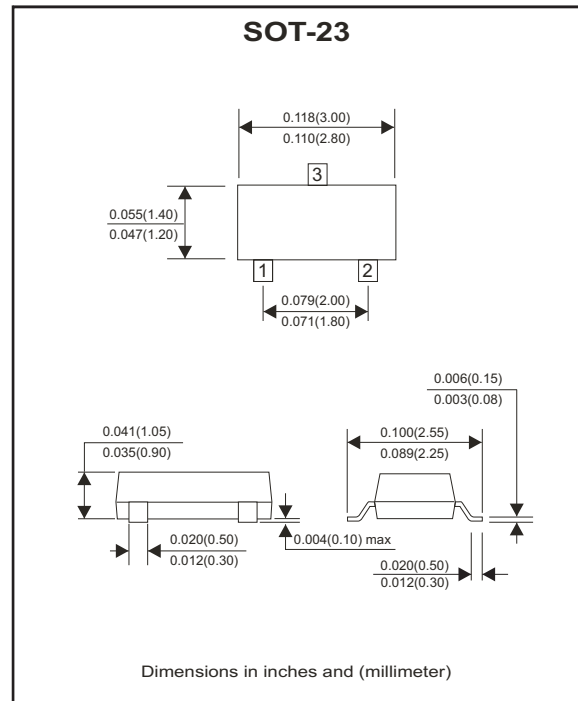
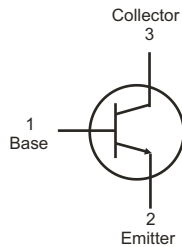

### Maximum Ratings (at TA=25°C unless otherwise noted)

Parameter	Symbol	Value	Unit
Collector-base voltage	$V_{CBO}$	180	V
Collector-emitter voltage	$V_{CEO}$	160	V
Emitter-base voltage	$V_{EBO}$	6	V
Collector current	$I_C$	600	mA
Collector power dissipation	$P_C$	300	mW
Thermal resistance from junction to ambient	$R_{\theta JA}$	416	°C/W
Junction temperature range	$T_J$	150	°C
Storage temperature range	$T_{STG}$	-55 ~ +150	°C

## Electrical Characteristics (at $T_A=25^\circ\text{C}$ unless otherwise noted)

Parameter	Conditions	Symbol	Min.	Typ.	Max.	Unit
Collector-base breakdown voltage	$I_C=100\mu\text{A}$ , $I_E=0$	$V_{(BR)CBO}$	180			V
Collector-emitter breakdown voltage	$I_C=1\text{mA}$ , $I_B=0$	$V_{(BR)CEO}^*$	160			V
Emitter-base breakdown voltage	$I_E=10\mu\text{A}$ , $I_C=0$	$V_{(BR)EBO}$	6			V
Collector cut-off current	$V_{CB}=120\text{V}$ , $I_E=0$	$I_{CBO}$			50	nA
Emitter cut-off current	$V_{EB}=4\text{V}$ , $I_C=0$	$I_{EBO}$			50	nA
DC current gain	$V_{CE}=5\text{V}$ , $I_C=1\text{mA}$	$h_{FE(1)}^*$	80			
	$V_{CE}=5\text{V}$ , $I_C=10\text{mA}$	$h_{FE(2)}^*$	100		200	
	$V_{CE}=5\text{V}$ , $I_C=50\text{mA}$	$h_{FE(3)}^*$	50			
Collector-emitter saturation voltage	$I_C=10\text{mA}$ , $I_B=1\text{mA}$	$V_{CE(sat)1}^*$			0.15	V
	$I_C=50\text{mA}$ , $I_B=5\text{mA}$	$V_{CE(sat)2}^*$			0.20	V
Base-emitter saturation voltage	$I_C=10\text{mA}$ , $I_B=1\text{mA}$	$V_{BE(sat)1}^*$			1	V
	$I_C=50\text{mA}$ , $I_B=5\text{mA}$	$V_{BE(sat)2}^*$			1	V
Transition frequency	$V_{CE}=10\text{V}$ , $I_C=10\text{mA}$ , $f=100\text{MHz}$	$f_r$	100		300	MHz
Collector output capacitance	$V_{CB}=10\text{V}$ , $I_E=0$ , $f=1\text{MHz}$	$C_{ob}$			6	pF

\*Pulse test: pulse width  $\leq 300\mu\text{s}$ , duty cycle  $\leq 2.0\%$

## RATING AND CHARACTERISTIC CURVES (MMBT5551-G)

Fig.1 - Static Characteristic

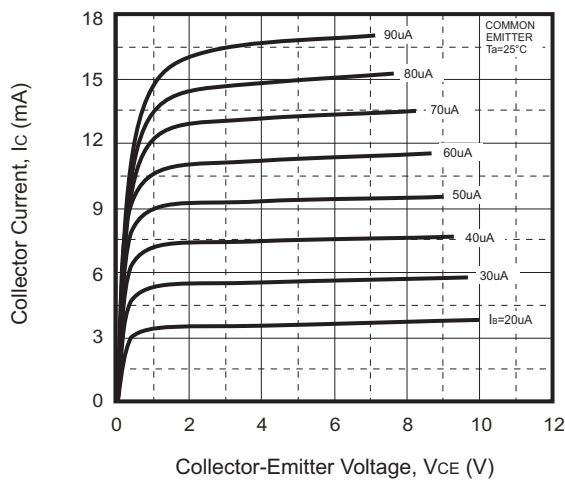
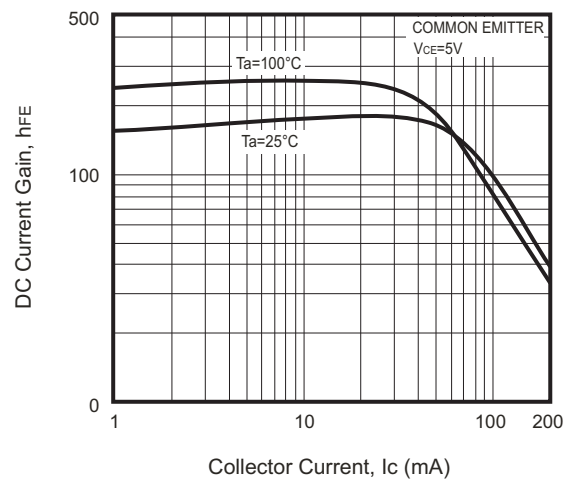

Fig.2 -  $h_{FE} - I_C$



## RATING AND CHARACTERISTIC CURVES (MMBT5551-G)

Fig.3 -  $V_{BEsat} - I_c$

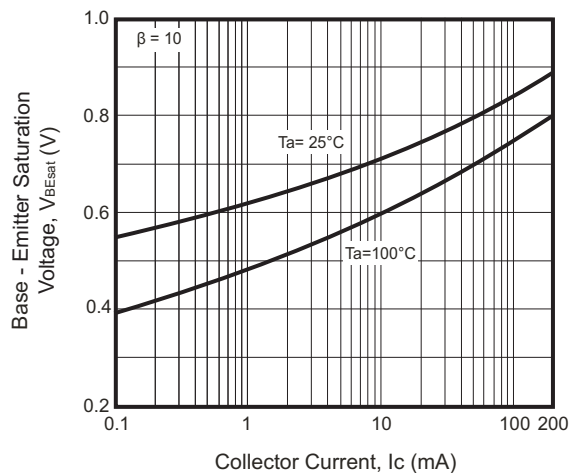

Fig.4 -  $V_{CEsat} - I_c$

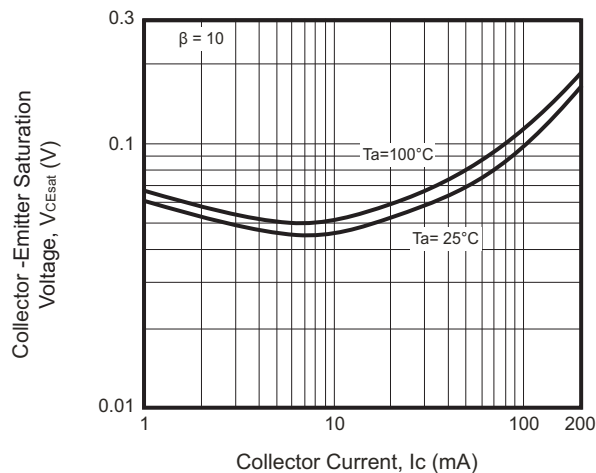

Fig.5 -  $I_c - V_{BE}$

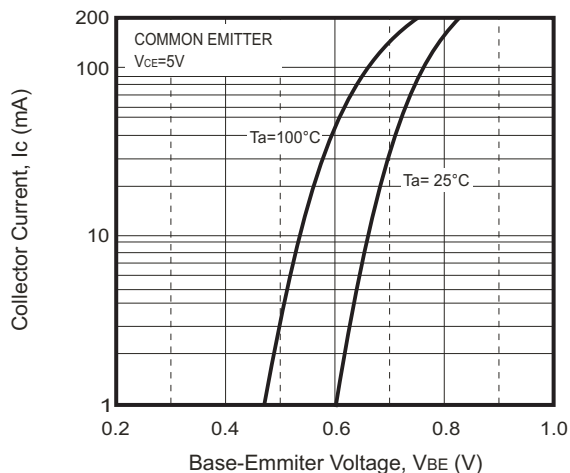

Fig.7 -  $C_{ob}/C_{ib} - V_{CB}/V_{EB}$

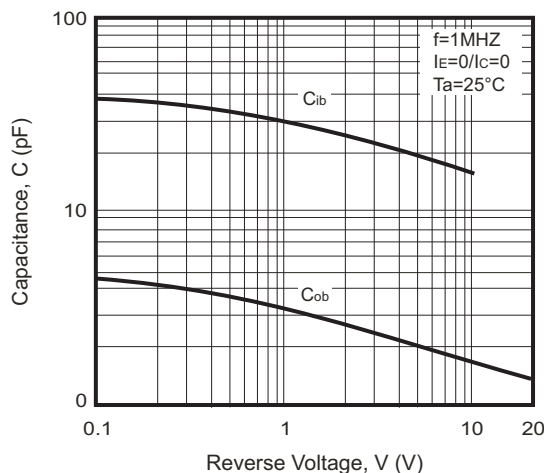

Fig.7 -  $f_T - I_c$

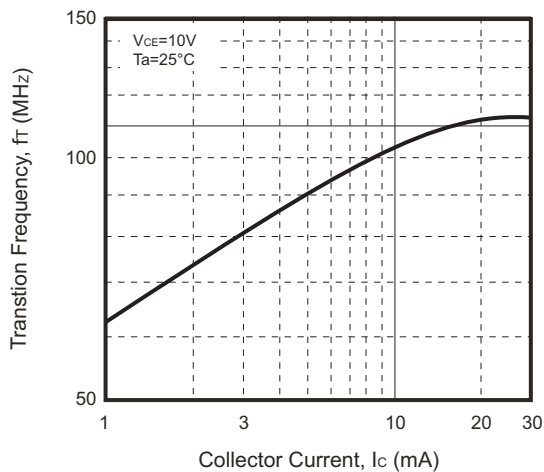
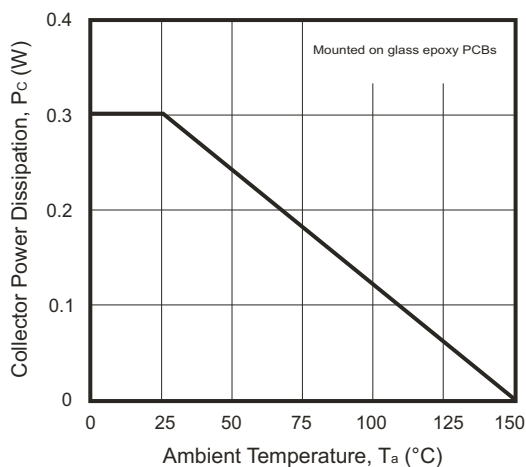
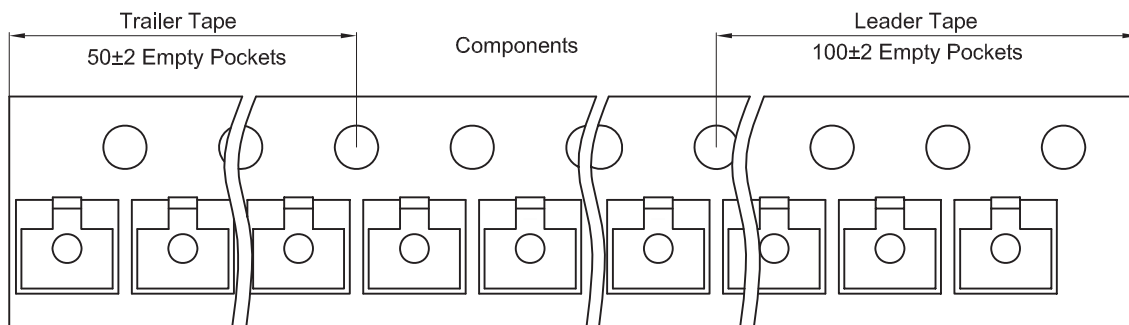
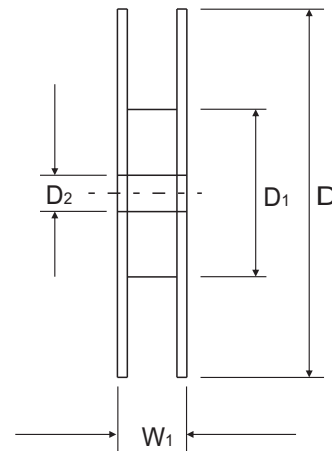
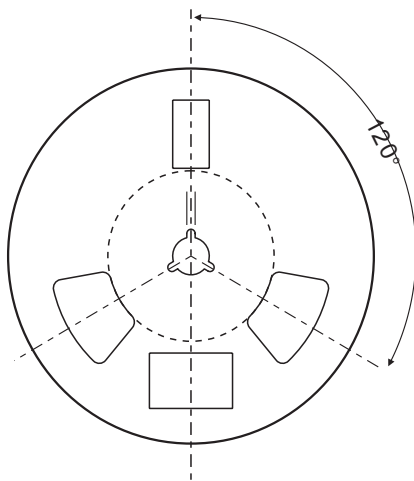
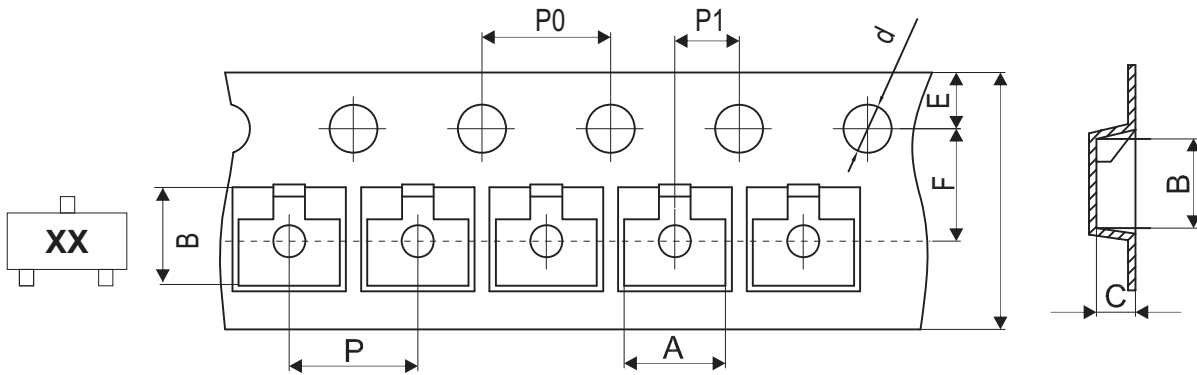

Fig.8 -  $P_c - T_a$



## Reel Taping Specification



SOT-23	SYMBOL	A	B	C	d	D	D1	D2
	(mm)	3.15 ± 0.10	2.77 ± 0.10	1.22 ± 0.10	1.50 ± 0.10	178.00 ± 2.00	54.40 ± 1.00	13.00 ± 1.00
	(inch)	0.124 ± 0.004	0.109 ± 0.004	0.048 ± 0.004	0.059 ± 0.004	7.008 ± 0.079	2.142 ± 0.039	0.512 ± 0.039

SOT-23	SYMBOL	E	F	P	P0	P1	W	W1
	(mm)	1.75 ± 0.10	3.50 ± 0.10	4.00 ± 0.10	4.00 ± 0.10	2.00 ± 0.10	8.00 + 0.30 / - 0.10	12.30 ± 1.00
	(inch)	0.069 ± 0.004	0.138 ± 0.004	0.157 ± 0.004	0.157 ± 0.004	0.079 ± 0.004	0.315 + 0.012 / - 0.004	0.484 ± 0.039

## Marking Code

Part Number	Marking Code
MMBT5551-G	G1

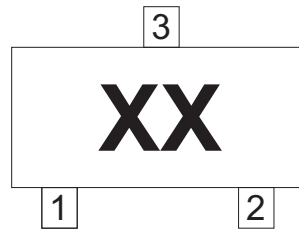

xx = Product type marking code

## Suggested PAD Layout

SIZE	SOT-23	
	(mm)	(inch)
A	0.60	0.024
B	0.80	0.031
C	1.90	0.075
D	2.02	0.080
E	2.82	0.111

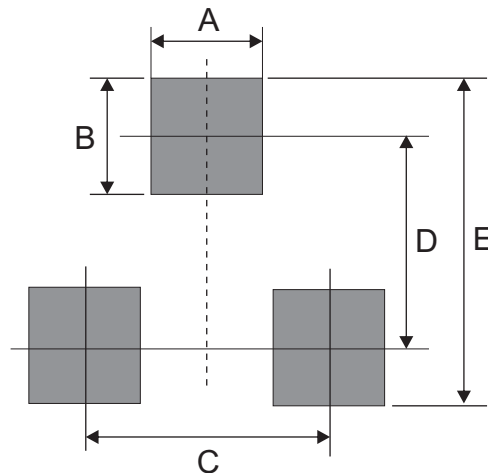

## Standard Packaging

Case Type	Qty Per Reel	Reel Size
	(Pcs)	(inch)
SOT-23	3,000	7

# Mouser Electronics

Authorized Distributor

Click to View Pricing, Inventory, Delivery & Lifecycle Information:

[Comchip Technology:](#)

[MMBT5551-G](#)