

















Pressure regulator, Series NL1-RGS

- G 1/8 G 1/4
- Qn = 1000 l/min
- Standard pressure regulator
- Activation Mechanical
- suitable for ATEX



Parts	Pressure regulator
Mounting orientation	Any
Certificates	suitable for ATEX
Working pressure min./max.	0,5 ... 16 bar
Ambient temperature min./max.	-10 ... 60 °C
Medium temperature min./max.	-10 ... 60 °C
Medium	Compressed air Neutral gases
Regulator type	Diaphragm-type pressure regulator Can be assembled into blocks
Regulator function	with relieving air exhaust
Adjustment range min./max.	See table below
Pressure supply	single
Activation	Mechanical
Weight	See table below

Technical data

Part No.			Port	Flow	Adjustment range min./max.	Pressure gauge
				Qn		
0821302728			G 1/8	1000 l/min	0,1 ... 3 bar	with pressure gauge
0821302729			G 1/8	1000 l/min	0,2 ... 6 bar	with pressure gauge
0821302730			G 1/8	1000 l/min	0,5 ... 10 bar	with pressure gauge
0821302725		—	G 1/8	1000 l/min	0,1 ... 3 bar	-
0821302726		—	G 1/8	1000 l/min	0,2 ... 6 bar	-
0821302727		—	G 1/8	1000 l/min	0,5 ... 10 bar	-
0821302734			G 1/4	1000 l/min	0,1 ... 3 bar	with pressure gauge
0821302735			G 1/4	1000 l/min	0,2 ... 6 bar	with pressure gauge
0821302736			G 1/4	1000 l/min	0,5 ... 10 bar	with pressure gauge
0821302731		—	G 1/4	1000 l/min	0,1 ... 3 bar	-
0821302732		—	G 1/4	1000 l/min	0,2 ... 6 bar	-
0821302733		—	G 1/4	1000 l/min	0,5 ... 10 bar	-

Part No.	Weight
0821302728	0,294 kg
0821302729	0,294 kg
0821302730	0,294 kg
0821302725	0,24 kg
0821302726	0,24 kg
0821302727	0,24 kg
0821302734	0,294 kg
0821302735	0,294 kg
0821302736	0,294 kg

Part No.	Weight
0821302731	0,24 kg
0821302732	0,24 kg
0821302733	0,24 kg

Nominal flow Qn with secondary pressure p2 = 6 bar at Δp = 1 bar

Suitable for use in Ex zones 1, 2, 21, 22.

Technical information

The pressure dew point must be at least 15 °C under ambient and medium temperature and may not exceed 3 °C .

Suitable for use in Ex zones 1, 2, 21, 22.

Relieving exhaust (≤ 0.3 bar over set pressure).

With rear exhaust (> 3 bar).

The rear pressure gauge connection on the pressure regulator is closed with a blanking plug, the front connection is open. Depending on the customer application, a second blanking plug may be necessary. Please order separately (see accessories).

A change in the flow direction (from air supply on the left to air supply on the right) occurs by rotating installation by 180° about the vertical axis. Please see the operating instructions for further details.

lockable regulator head

Recommended pre-filtering 5 μm

Technical information

Material	
Housing	Die cast zinc
Seals	Acrylonitrile butadiene rubber

Dimensions

Dimensions

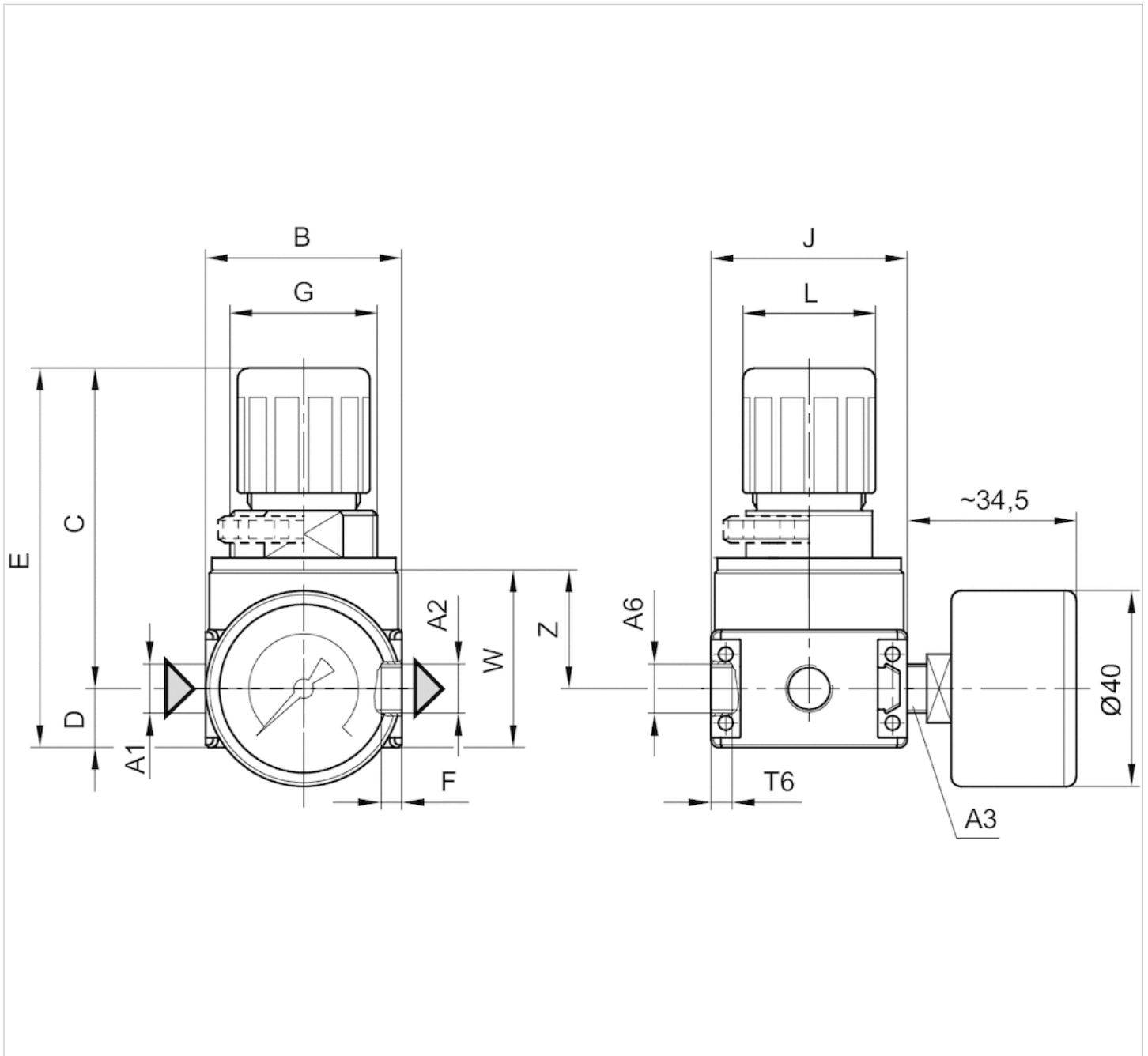

- A1 = input
- A2 = output
- A3 = pressure gauge connection
- A6 = ventilation port

Dimensions in mm

A1	A2	A3	A6	B	C	D	E	G	J	L	T2	T6	W	Z
G 1/8	G 1/8	G 1/8	G 1/8	40	65.5	12	77.5	M30x1,5	40	27	8	6	36.2	24.2
G 1/8	G 1/8	G 1/8	G 1/8	40	65.5	12	77.5	M30x1,5	40	27	8	6	36.2	36.2
G 1/8	G 1/8	G 1/8	G 1/8	40	65.5	12	77.5	M30x1,5	40	27	8	6	36.2	24.2
G 1/4	G 1/4	G 1/8	G 1/8	40	65.5	12	77.5	M30x1,5	40	27	8	6	36.2	24.2

Diagrams

Pressure characteristics curve

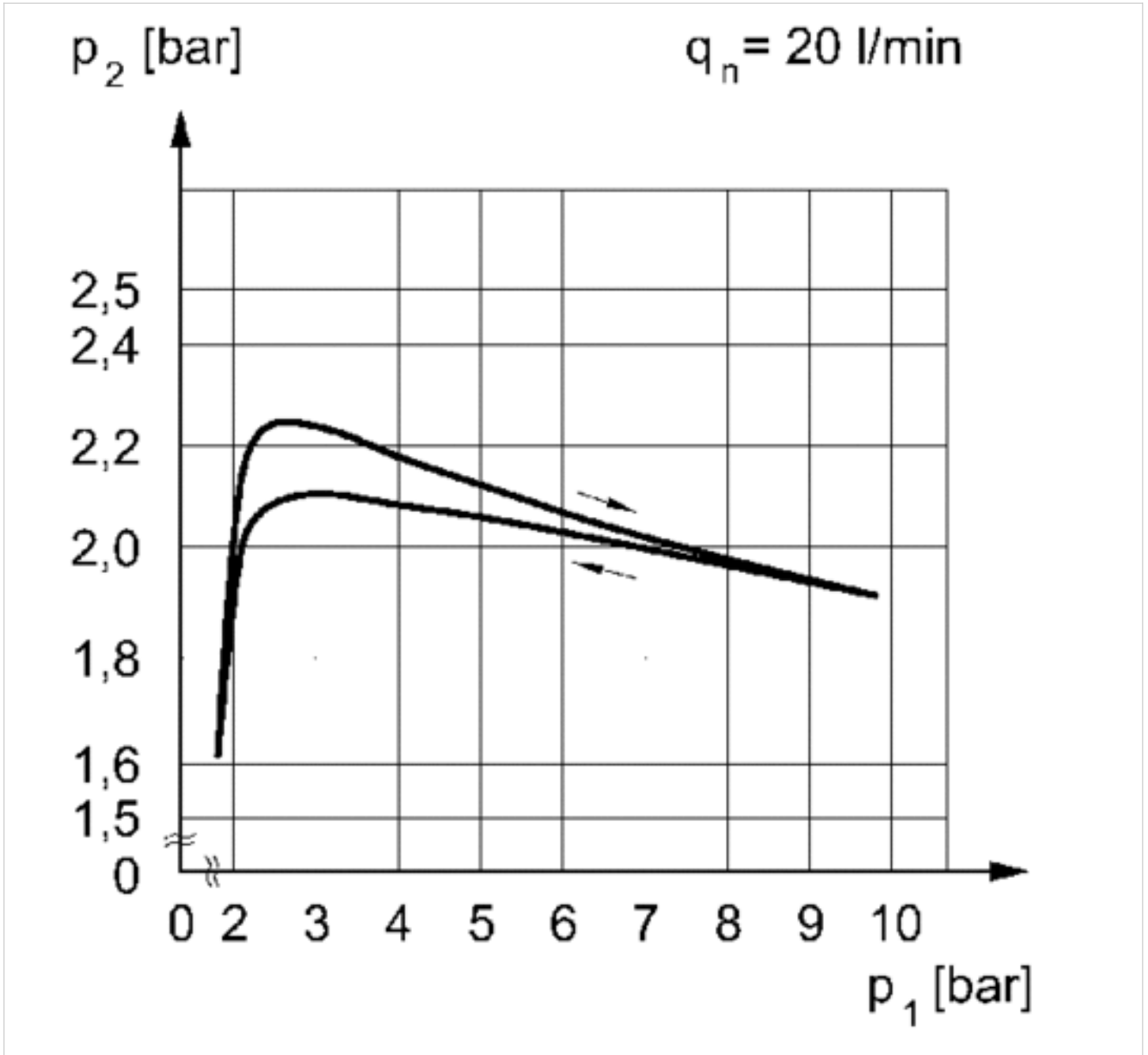

p_1 = Working pressure
 p_2 = Secondary pressure
 q_n = Nominal flow

Flow rate characteristic (setting range p2: 0.5 - 10 bar)

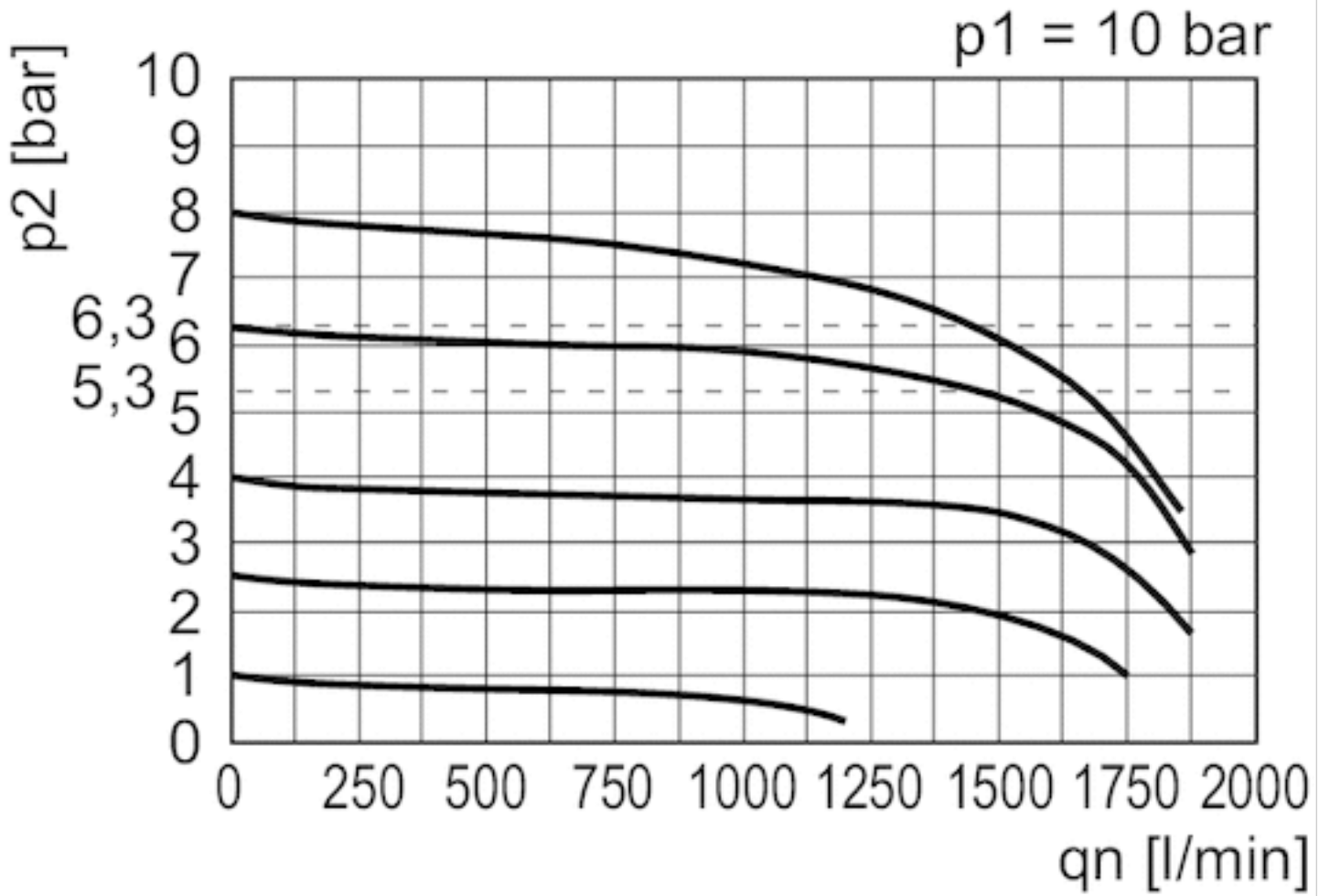

p1 = Working pressure
p2 = Secondary pressure
qn = Nominal flow

Efficient pneumatic solutions, our program: cylinders and drives, valves and valve systems, air supply management



Visit us: [Emerson.com/Aventics](https://www.emerson.com/Aventics)

Your local contact: [Emerson.com/contactus](https://www.emerson.com/contactus)



Emerson.com



Facebook.com/EmersonAutomationSolutions



LinkedIn.com/company/Emerson-Automation-Solutions



Twitter.com/EMR_Automation

An example configuration is depicted on the title page. The delivered product may thus vary from that in the illustration. Subject to change. This Document, as well as the data, specifications and other information set forth in it, are the exclusive property of AVENTICS GmbH. It may not be reproduced or given to third parties without its consent. Only use the AVENTICS products shown in industrial applications. Read the product documentation completely and carefully before using the product. Observe the applicable regulations and laws of the respective country. When integrating the product into applications, note the system manufacturer's specifications for safe use of the product. The data specified only serve to describe the product. No statements concerning a certain condition or suitability for a certain application can be derived from our information. The information given does not release the user from the obligation of own judgement and verification. It must be remembered that the products are subject to a natural process of wear and aging.

The Emerson logo is a trademark and service mark of Emerson Electric Co. Brand logotype are registered trademarks of one of the Emerson family of companies. All other marks are the property of their respective owners. © 2020 Emerson Electric Co. All rights reserved.
2020-12



CONSIDER IT SOLVED™