



RF LDMOS Wideband Integrated Power Amplifier

The AFIC901N is a 2-stage, high gain amplifier designed to provide a high level of flexibility to the amplifier designer. The device is unmatched even at the interstage, allowing performance to be optimized for any frequency in the 1.8 to 1000 MHz range. The high gain, ruggedness and wideband performance of this device make it ideal for use as a pre-driver and driver in a wide range of industrial, medical and communications applications.

Typical Narrowband Performance (7.5 Vdc, T_A = 25°C, CW)

Frequency (MHz)	G _{ps} (dB)	η _D (%)	P _{out} (dBm)
520 (1)	32.2	73.0	31.2

Typical Wideband Performance (7.5 Vdc, T_A = 25°C, CW)

Frequency (MHz)	P _{in} (dBm)	G _{ps} (dB)	η _D (%)	P _{out} (dBm)
136–174 (2,5)	0	30.6	62.1	30.6
350–520 (3,5)	3	27.4	61.5	30.4
760–870 (4,5)	3	27.6	57.0	30.6

Load Mismatch/Ruggedness

Frequency (MHz)	Signal Type	VSWR	P _{in} (W)	Test Voltage	Result
175 (2)	CW	> 25:1 at all Phase Angles	3 dB Overdrive from rated power	9	No Device Degradation
520 (3)					

1. Measured in 520 MHz narrowband test circuit.
2. Measured in 136–174 MHz VHF broadband reference circuit.
3. Measured in 350–520 MHz UHF broadband reference circuit.
4. Measured in 760–870 MHz broadband reference circuit.
5. The values shown are the center band performance numbers across the indicated frequency range.

Features

- Characterized for Operation from 1.8 to 1000 MHz
- Unmatched Input, Interstage and Output Allowing Wide Frequency Range Utilization
- Integrated ESD Protection
- Same PCB Layout Can be Used for 136–174 MHz, 350–520 MHz and 760–870 MHz Designs.
- 24-pin, 4 mm QFN Plastic Package

Typical Applications

- Driver for Mobile Radio Power Amplifiers
- Output Stage for Low Power Handheld Radios
- Driver for Communications and Industrial Systems

AFIC901N

**1.8–1000 MHz, 30 dBm, 7.5 V
 AIRFAST RF LDMOS WIDEBAND
 INTEGRATED POWER AMPLIFIER**

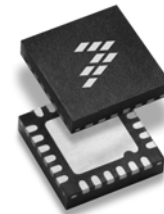

QFN 4 × 4

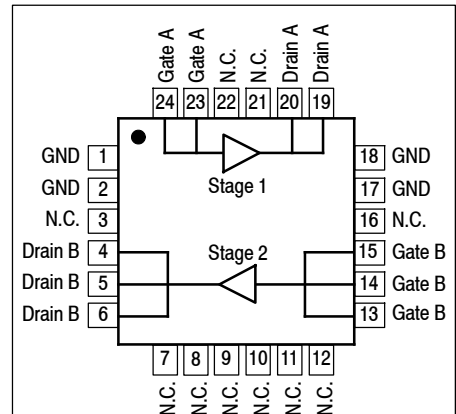

Note: Exposed backside of the package is the source terminal for the transistors.

Figure 1. Pin Connections

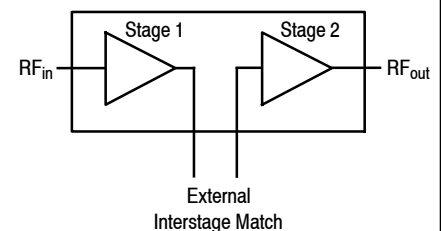

Figure 2. Typical Application



Table 1. Maximum Ratings

Rating	Symbol	Value	Unit
Drain-Source Voltage	V_{DSS}	-0.5, +30	Vdc
Gate-Source Voltage	V_{GS}	-6.0, +12	Vdc
Storage Temperature Range	T_{stg}	-65 to +150	°C
Case Operating Temperature Range	T_C	-40 to +150	°C
Operating Junction Temperature Range (1,2)	T_J	-40 to +150	°C

Table 2. Thermal Characteristics

Characteristic	Symbol	Value (2,3)	Unit
Thermal Resistance, Junction to Case Case Temperature 78°C, 30 dBm CW, 520 MHz Stage 1, 7.5 Vdc, $I_{DQ1} = 8$ mA Stage 2, 7.5 Vdc, $I_{DQ2} = 24$ mA	$R_{\theta JC}$	32 9.4	°C/W

Table 3. ESD Protection Characteristics

Test Methodology	Class
Human Body Model (per JESD22-A114)	1A, passes 250 V
Machine Model (per EIA/JESD22-A115)	A
Charge Device Model (per JESD22-C101)	II, passes 200 V

Table 4. Moisture Sensitivity Level

Test Methodology	Rating	Package Peak Temperature	Unit
Per JESD22-A113, IPC/JEDEC J-STD-020	3	260	°C

1. Continuous use at maximum temperature will affect MTTF.
2. MTTF calculator available at <http://www.nxp.com/RF/calculators>.
3. Refer to AN1955, *Thermal Measurement Methodology of RF Power Amplifiers*. Go to <http://www.nxp.com/RF> and search for AN1955.

Table 5. Electrical Characteristics ($T_A = 25^\circ\text{C}$ unless otherwise noted)

Characteristic	Symbol	Min	Typ	Max	Unit
Stage 1 - Off Characteristics (1)					
Zero Gate Voltage Drain Leakage Current ($V_{DS} = 30\text{ Vdc}$, $V_{GS} = 0\text{ Vdc}$)	I_{DSS}	—	—	1	$\mu\text{A dc}$
Drain-Source Breakdown Voltage ($V_{GS} = 0\text{ Vdc}$, $I_D = 1\ \mu\text{A dc}$)	$V_{(BR)DSS}$	30	37	—	Vdc
Gate-Source Leakage Current ($V_{GS} = 5\text{ Vdc}$, $V_{DS} = 0\text{ Vdc}$)	I_{GSS}	—	—	500	nA dc

Stage 1 - On Characteristics (1)

Gate Threshold Voltage ($V_{DS} = 10\text{ Vdc}$, $I_D = 6\ \mu\text{A dc}$)	$V_{GS(th)}$	1.8	2.2	2.6	Vdc
Drain-Source On-Voltage ($V_{GS} = 10\text{ Vdc}$, $I_D = 46\text{ mA dc}$)	$V_{DS(on)}$	—	0.24	—	Vdc
Forward Transconductance ($V_{DS} = 7.5\text{ Vdc}$, $I_D = 0.1\text{ A dc}$)	g_{fs}	—	0.096	—	S

Stage 2 - Off Characteristics (1)

Zero Gate Voltage Drain Leakage Current ($V_{DS} = 30\text{ Vdc}$, $V_{GS} = 0\text{ Vdc}$)	I_{DSS}	—	—	1	$\mu\text{A dc}$
Drain-Source Breakdown Voltage ($V_{GS} = 0\text{ Vdc}$, $I_D = 1\ \mu\text{A dc}$)	$V_{(BR)DSS}$	30	37	—	Vdc
Gate-Source Leakage Current ($V_{GS} = 5\text{ Vdc}$, $V_{DS} = 0\text{ Vdc}$)	I_{GSS}	—	—	500	nA dc

Stage 2 - On Characteristics (1)

Gate Threshold Voltage ($V_{DS} = 10\text{ Vdc}$, $I_D = 25\ \mu\text{A dc}$)	$V_{GS(th)}$	1.7	2.1	2.5	Vdc
Drain-Source On-Voltage ($V_{GS} = 10\text{ Vdc}$, $I_D = 380\text{ mA dc}$)	$V_{DS(on)}$	—	0.23	—	Vdc
Forward Transconductance ($V_{DS} = 7.5\text{ Vdc}$, $I_D = 1.1\text{ A dc}$)	g_{fs}	—	1.1	—	S

Functional Tests (In Freescale Narrowband Test Fixture, 50 ohm system) $V_{DD} = 7.5\text{ Vdc}$, $I_{DQ1} = 8\text{ mA}$, $I_{DQ2} = 24\text{ mA}$,
 $P_{in} = -1\text{ dBm}$, $f = 520\text{ MHz}$

Output Power	P_{out}	—	31.2	—	dBm
Power Gain	G_{ps}	—	32.2	—	dB
Drain Efficiency	η_D	—	73.0	—	%

Table 6. Ordering Information

Device	Tape and Reel Information	Package
AFIC901NT1	T1 Suffix = 1,000 Units, 12 mm Tape Width, 7-inch Reel	QFN 4 × 4

1. Each side of device measured separately.

136–174 MHz VHF BROADBAND REFERENCE CIRCUIT

Table 7. 136–174 MHz VHF Broadband Performance (In Freescale Reference Circuit, 50 ohm system)

$V_{DD} = 7.5$ Vdc, $I_{DQ1} = 10$ mA, $I_{DQ2} = 30$ mA

Frequency (MHz)	P_{in} (dBm)	G_{ps} (dB)	η_D (%)	P_{out} (dBm)
135	-0.8	30.8	65.9	30.0
155	-1.3	31.3	59.6	30.0
175	-1.1	31.1	61.4	30.0

Table 8. Load Mismatch/Ruggedness (In Freescale 136–174 MHz Reference Circuit, 50 ohm system) $I_{DQ1} = 10$ mA, $I_{DQ2} = 30$ mA

Frequency (MHz)	Signal Type	VSWR	P_{in} (W)	Test Voltage, V_{DD}	Result
175	CW	> 25:1 at all Phase Angles	3 dB Overdrive from rated power	9	No Device Degradation

136–174 MHz VHF Broadband Reference Circuit — 0.83" × 1.86" (2.11 cm × 4.72 cm)

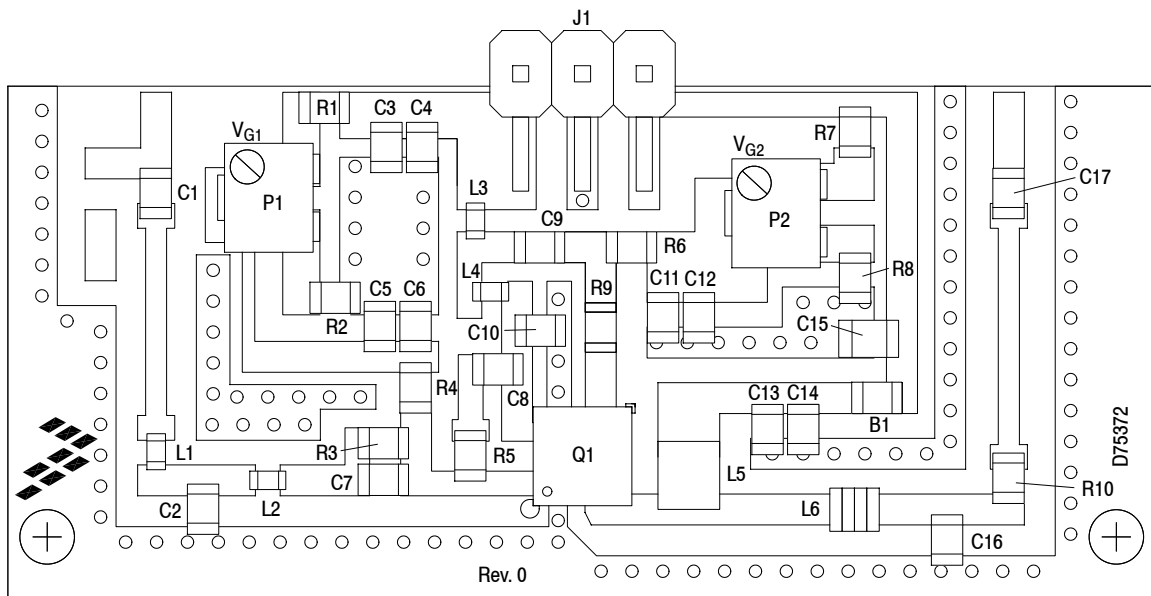

Figure 3. AFIC901N VHF Broadband Reference Circuit Component Layout — 136–174 MHz

Table 9. AFIC901N VHF Broadband Reference Circuit Component Designations and Values — 136–174 MHz

Part	Description	Part Number	Manufacturer
B1	RF Bead	2508051107Y0	Fair-Rite
C1, C5, C9, C12, C14, C17	1000 pF Chip Capacitors	C2012X7R2E102M085AA	TDK
C2, C16	15 pF Chip Capacitors	GQM2195C2E150FB12D	Murata
C3	1 μ F Chip Capacitor	GRM21BR71H105KA12L	Murata
C4, C6, C7, C8, C11, C13	100 pF Chip Capacitors	GQM2195C2E101GB12D	Murata
C10	6.2 pF Chip Capacitor	GQM2195C2E6R2BB12D	Murata
C15	10 μ F Chip Capacitor	GRM31CR61H106KA12L	Murata
J1	Right-Angle Breakaway Headers (3 Pins)	22-28-8360	Molex
L1, L4	56 nH Inductors	LL1608-FSL56NJ	TOKO
L2	180 nH Inductor	LL1608-FSLR18J	TOKO
L3	120 nH Inductor	LL1608-FSLR12J	TOKO
L5	180 nH Inductor	1008CS-181XJLB	Coilcraft
L6	15.7 nH Inductor	0806SQ15N	Coilcraft
P1, P2	5.0 k Ω Multi-turn Cermet Trimmer Potentiometer	3224W-1-502E	Bourns
Q1	RF Power LDMOS Amplifier	AFIC901NT1	Freescale
R1, R7	15 k Ω , 1/10 W Chip Resistors	RR1220P-153-B-T5	Susumu
R2, R8	10 k Ω , 1/8 W Chip Resistors	CRCW080510K0FKEA	Vishay
R3	200 Ω , 1/8 W Chip Resistor	CRCW0805200RJNEA	Vishay
R4, R6	1.2 k Ω , 1/8 W Chip Resistors	CRCW08051K20FKEA	Vishay
R5	510 Ω , 1/10 W Chip Resistor	RR1220P-511-B-T5	Susumu
R9, R10	0 Ω , 2.5 A Chip Resistors	CWCR08050000Z0EA	Vishay
PCB	FR4 (S-1000), 0.020", $\epsilon_r = 4.8$	D75372	MTL

TYPICAL CHARACTERISTICS — 136–174 MHz VHF BROADBAND REFERENCE CIRCUIT

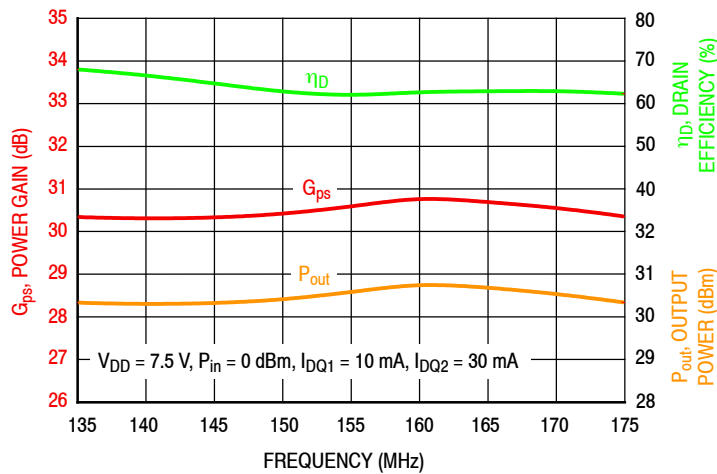

Figure 4. Power Gain, Drain Efficiency and Output Power versus Frequency at a Constant Input Power

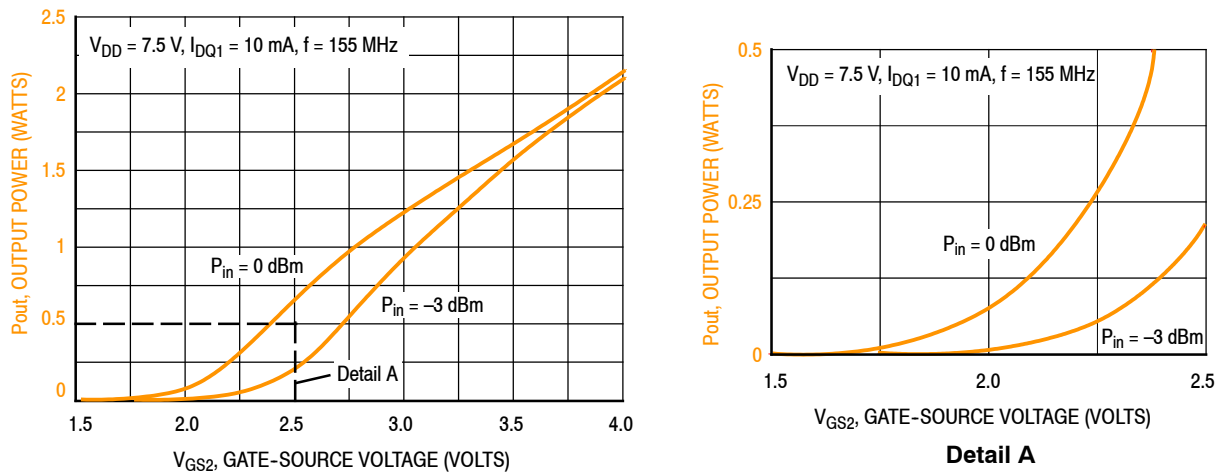

Figure 5. Output Power versus Gate-Source Voltage, 2nd Stage

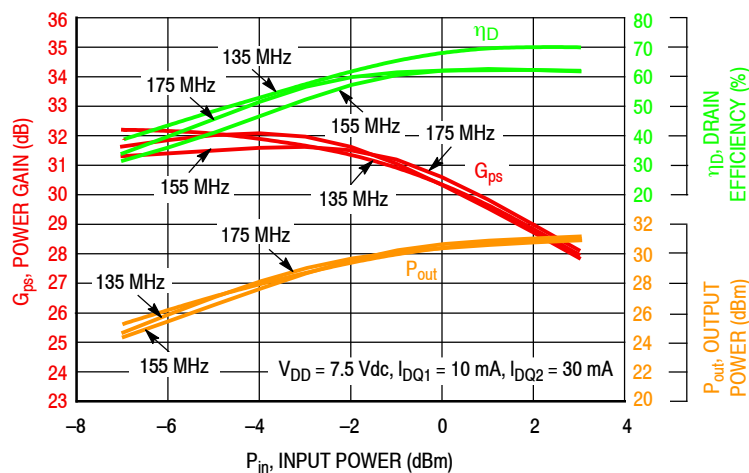
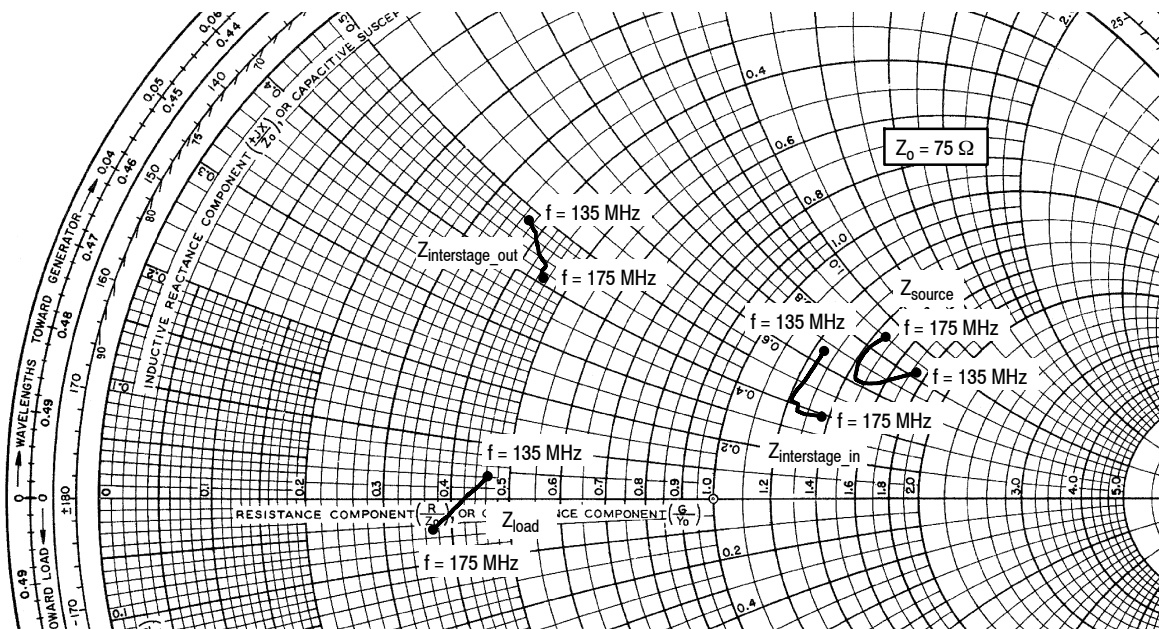

Figure 6. Power Gain, Drain Efficiency and Output Power versus Input Power and Frequency

136–174 MHz VHF BROADBAND REFERENCE CIRCUIT



f MHz	Z _{source1} Ω	Z _{load1} Ω	Z _{source2} Ω	Z _{load2} Ω
135	129.8 + j62.2	93.0 + j49.5	27.8 + j35.9	34.3 + j2.85
140	123.1 + j54.4	92.5 + j42.5	29.4 + j35.1	33.4 + j1.92
145	117.3 + j49.7	91.6 + j37.2	30.7 + j34.1	32.5 + j1.00
150	112.5 + j47.8	91.0 + j33.3	31.8 + j33.1	31.7 + j0.08
155	109.1 + j47.7	90.9 + j30.7	32.7 + j32.2	30.9 – j0.83
160	107.1 + j49.6	91.9 + j29.2	33.2 + j31.4	30.0 – j1.66
165	106.3 + j53.5	93.9 + j28.6	33.6 + j31.0	29.1 – j2.41
170	106.8 + j59.2	97.4 + j28.7	33.9 + j30.9	28.2 – j3.03
175	108.3 + j67.5	102.6 + j29.4	34.1 + j31.1	27.4 – j3.49

Z_{source} = Test circuit impedance as measured from gate to gate.
 Z_{load} = Test circuit impedance as measured from drain to drain.

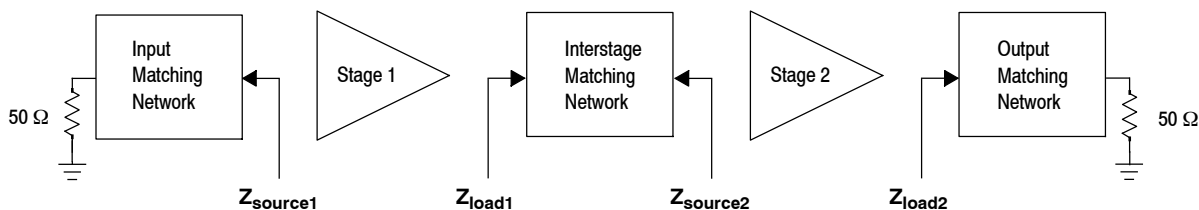

Figure 7. VHF Broadband Series Equivalent Source and Load Impedance — 136-174 MHz

350–520 MHz UHF BROADBAND REFERENCE CIRCUIT

Table 10. 350–520 MHz UHF Broadband Performance (In Freescale Reference Circuit, 50 ohm system)

$V_{DD} = 7.5 \text{ Vdc}$, $I_{DQ1} = 10 \text{ mA}$, $I_{DQ2} = 30 \text{ mA}$

Frequency (MHz)	P_{in} (dBm)	G_{ps} (dB)	η_D (%)	P_{out} (dBm)
350	2.3	27.7	52.8	30.0
435	2.1	27.9	59.6	30.0
520	2.4	27.6	66.3	30.0

Table 11. Load Mismatch/Ruggedness (In Freescale 350–520 MHz Reference Circuit, 50 ohm system) $I_{DQ1} = 100 \text{ mA}$, $I_{DQ2} = 30 \text{ mA}$

Frequency (MHz)	Signal Type	VSWR	P_{in} (W)	Test Voltage, V_{DD}	Result
520	CW	> 25:1 at all Phase Angles	3 dB Overdrive from rated power	9	No Device Degradation

350–520 MHz UHF BROADBAND REFERENCE CIRCUIT — 0.83" × 1.86" (2.11 cm × 4.72 cm)

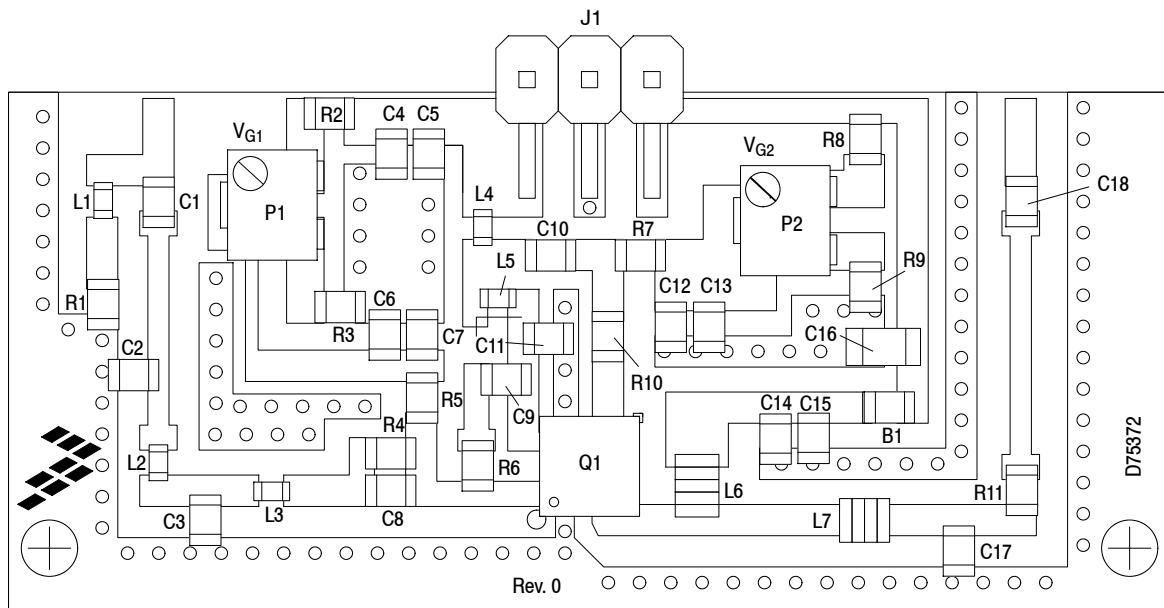

Figure 8. AFIC901N UHF Broadband Reference Circuit Component Layout — 350–520 MHz

Table 12. AFIC901N UHF Broadband Reference Circuit Component Designations and Values — 350–520 MHz

Part	Description	Part Number	Manufacturer
B1	RF Bead	2508051107Y0	Fair-Rite
C1, C5, C7, C9, C10, C12, C14, C18	100 pF Chip Capacitors	GQM2195C2E101GB12D	Murata
C2	10 pF Chip Capacitor	GQM2195C2E100FB12D	Murata
C3	12 pF Chip Capacitor	GQM2195C2E120FB12D	Murata
C4	1 μ F Chip Capacitor	GRM21BR71H105KA12L	Murata
C6, C13, C15	1000 pF Chip Capacitors	C2012X7R2E102M085AA	TDK
C8	39 pF Chip Capacitor	GQM2195C2E390GB12D	Murata
C11	4.7 pF Chip Capacitor	GQM2195C2E4R7BB12D	Murata
C16	10 μ F Chip Capacitor	GRM31CR61H106KA12L	Murata
C17	6.8 pF Chip Capacitor	GQM2195C2E6R8BB12D	Murata
J1	Right-Angle Breakaway Headers (3 Pins)	22-28-8360	Molex
L1, L4	120 nH Inductors	LL1608-FSLR12J	TOKO
L2	12 nH Inductor	LL1608-FSL12NJ	TOKO
L3	39 nH Inductor	LL1608-FSL39NJ	TOKO
L5	15 nH Inductor	LL1608-FSL15NJ	TOKO
L6	25 nH Inductor	0908SQ25N	Coilcraft
L7	8.1 nH Inductor	0908SQ8N1	Coilcraft
P1, P2	5.0 k Ω Multi-turn Cermet Trimmer Potentiometer	3224W-1-502E	Bourns
Q1	RF Power LDMOS Amplifier	AFIC901NT1	Freescale
R1	51 Ω , 1/4 W Chip Resistor	SG73P2ATTD51R0F	KOA Speer
R2, R8	15 k Ω , 1/10 W Chip Resistors	RR1220P-153-B-T5	Susumu
R3, R9	10 k Ω , 1/8 W Chip Resistors	CRCW080510K0FKEA	Vishay
R4	200 Ω , 1/8 W Chip Resistor	CRCW0805200RJNEA	Vishay
R5, R7	1.2 k Ω , 1/8 W Chip Resistors	CRCW08051K20FKEA	Vishay
R6	2.2 k Ω , 1/8 W Chip Resistor	CRCW08052K20JNEA	Vishay
R10, R11	0 Ω , 2.5 A Chip Resistors	CWCR08050000Z0EA	Vishay
PCB	FR4 (S-1000), 0.020", $\epsilon_r = 4.8$	D75372	MTL

AFIC901N

TYPICAL CHARACTERISTICS — 350–520 MHz UHF BROADBAND REFERENCE CIRCUIT

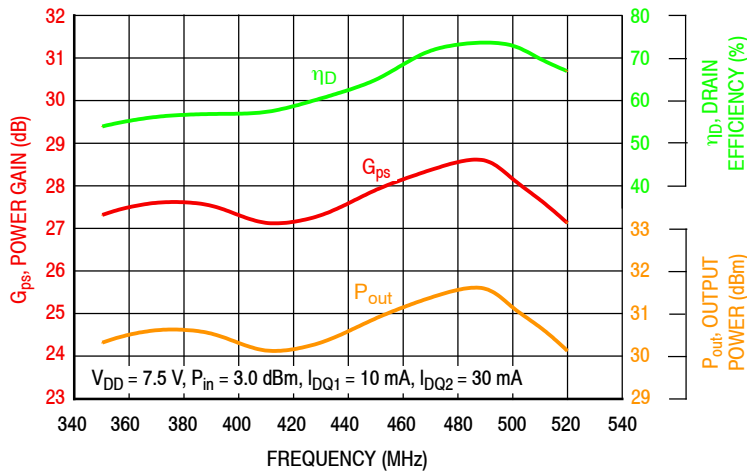

Figure 10. Power Gain, Drain Efficiency and Output Power versus Frequency at a Constant Input Power

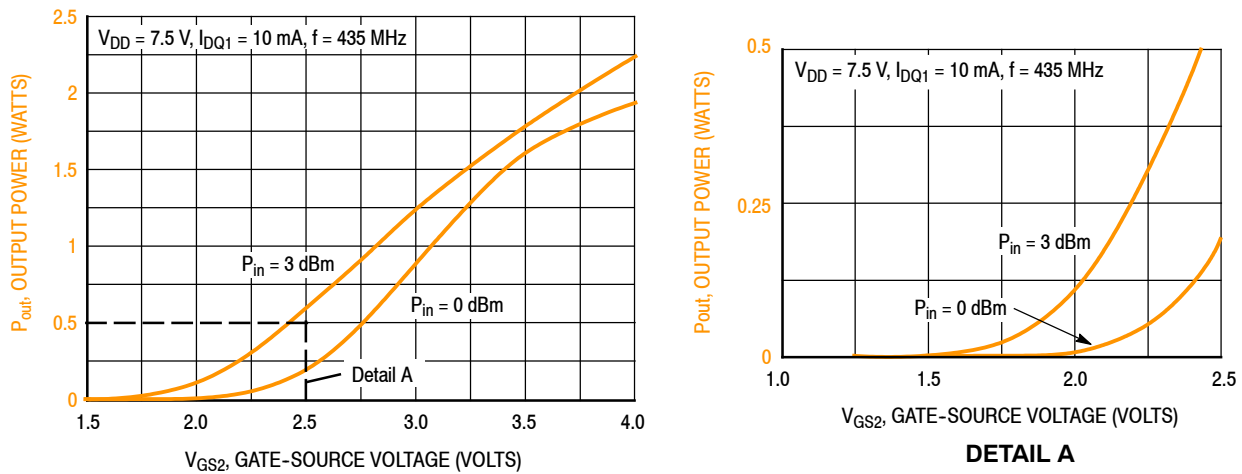

Figure 9. Output Power versus Gate-Source Voltage, 2nd Stage

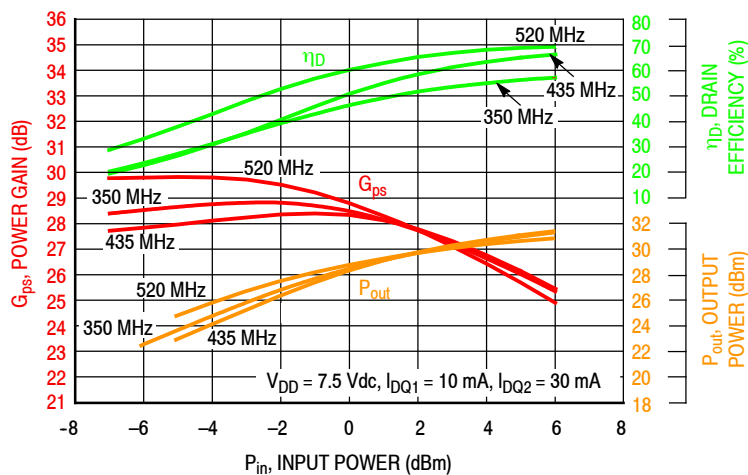
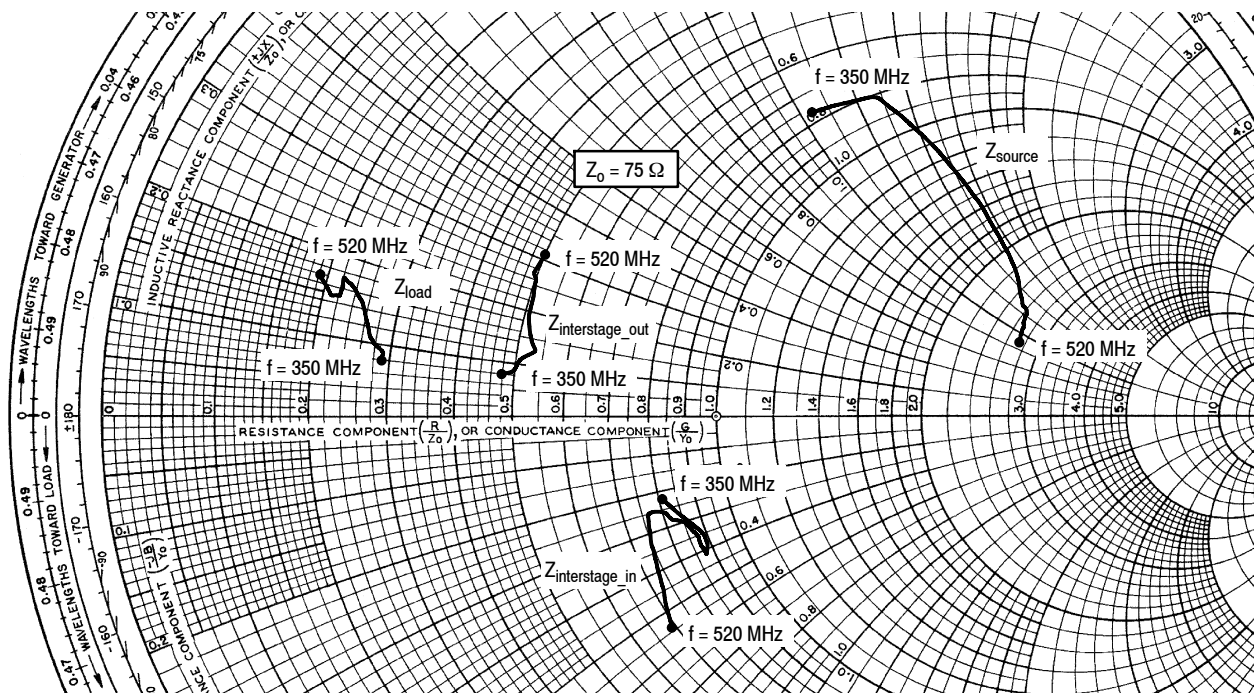

Figure 11. Power Gain, Drain Efficiency and Output Power versus Input Power and Frequency

350–520 MHz UHF BROADBAND REFERENCE CIRCUIT



f MHz	Z _{source1} Ω	Z _{load1} Ω	Z _{source2} Ω	Z _{load2} Ω
350	57.4 + j77.2	60.5 - j16.5	36.3 + j5.69	22.0 + j6.12
360	60.6 + j94.9	62.7 - j20.6	37.2 + j6.57	21.7 + j6.35
370	69.0 + j100.2	65.1 - j24.8	38.3 + j8.07	21.5 + j6.92
380	79.2 + j105.3	66.5 - j29.4	39.4 + j9.66	21.2 + j7.57
390	91.5 + j109.9	65.1 - j30.7	39.2 + j11.6	20.3 + j8.45
400	106.3 + j113.5	65.3 - j28.6	38.6 + j14.6	19.4 + j9.81
410	124.0 + j115.1	65.3 - j26.2	38.0 + j17.3	18.6 + j11.0
420	144.6 + j113.6	64.3 - j23.4	37.3 + j19.2	17.8 + j11.9
430	167.9 + j107.3	62.6 - j21.0	36.7 + j20.1	17.2 + j12.5
440	192.4 + j94.1	60.6 - j19.3	36.7 + j20.3	16.9 + j12.7
450	196.1 + j89.7	58.9 - j18.6	36.8 + j20.4	16.7 + j12.6
460	197.5 + j86.7	57.6 - j19.1	36.8 + j20.5	16.6 + j12.2
470	198.8 + j83.7	56.8 - j20.8	36.8 + j20.6	16.5 + j11.7
480	199.9 + j80.6	56.3 - j23.7	36.8 + j20.7	16.3 + j11.3
490	201.0 + j77.5	55.8 - j27.6	36.9 + j20.8	15.9 + j11.1
500	202.0 + j74.3	54.9 - j32.3	36.9 + j20.9	15.5 + j11.2
510	202.8 + j71.2	53.4 - j36.9	36.9 + j21.0	15.0 + j11.7
520	206.6 + j70.1	51.5 - j40.8	37.7 + j23.5	14.6 + j12.5

Z_{source} = Test circuit impedance as measured from gate to gate.

Z_{load} = Test circuit impedance as measured from drain to drain.

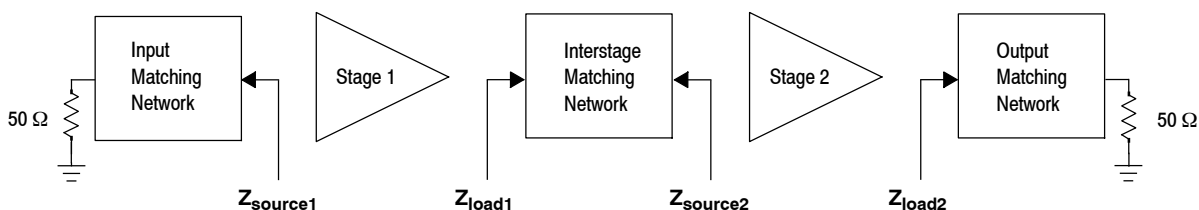

Figure 12. UHF Broadband Series Equivalent Source and Load Impedance — 350–520 MHz

AFIC901N

520 MHz NARROWBAND TEST FIXTURE

Table 13. 520 MHz Narrowband Performance $V_{DD} = 7.5$ Vdc, $I_{DQ1} = 8$ mA, $I_{DQ2} = 24$ mA, $P_{in} = -1$ dBm, $f = 520$ MHz

Characteristic	Symbol	Min	Typ	Max	Unit
Output Power	P_{out}	—	32.2	—	dBm
Power Gain	G_{ps}	—	31.2	—	dB
Drain Efficiency	η_D	—	73.0	—	%

520 MHz NARROWBAND TEST FIXTURE — 3" x 5" (7.6 cm x 12.7 cm)

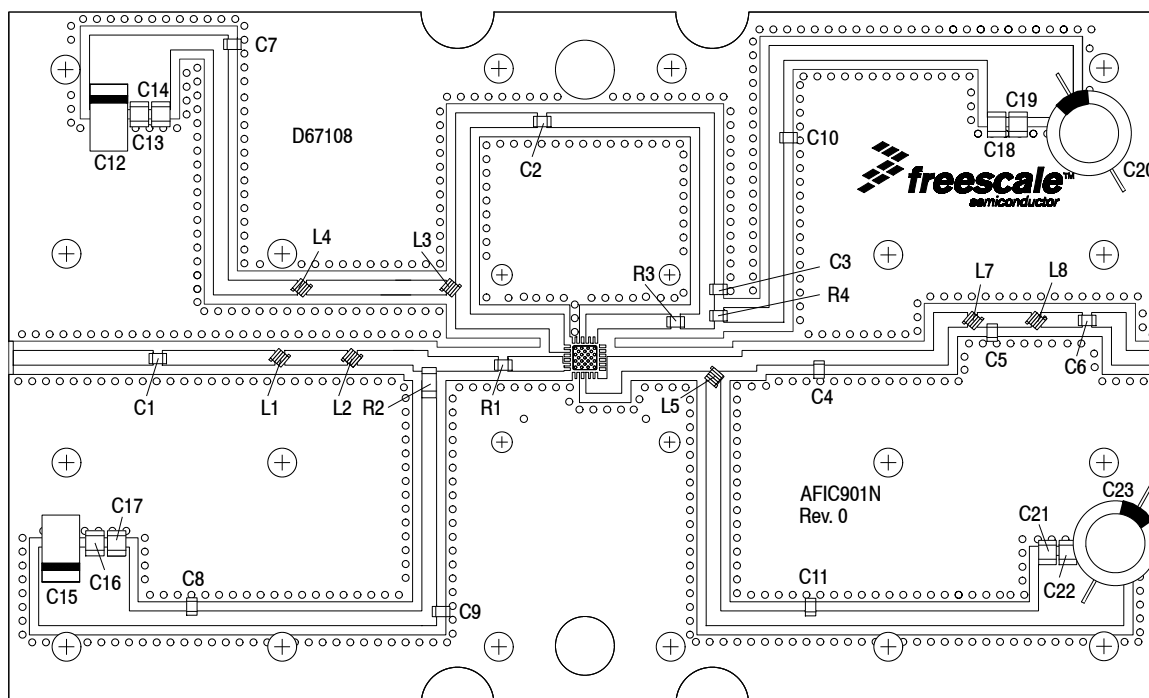

Figure 13. AFIC901N Narrowband Test Circuit Component Layout — 520 MHz

Table 14. AFIC901N Narrowband Test Circuit Component Designations and Values — 520 MHz

Part	Description	Part Number	Manufacturer
C1	8.2 pF Chip Capacitor	ATC600F8R2BT250XT	ATC
C2	240 pF Chip Capacitor	ATC600F241JT250XT	ATC
C3	39 pF Chip Capacitor	ATC600F390JT250XT	ATC
C4	15 pF Chip Capacitor	ATC600F150JT250XT	ATC
C5	4.7 pF Chip Capacitor	ATC600F4R7BT250XT	ATC
C6	12 pF Chip Capacitor	ATC600F120JT250XT	ATC
C7, C8, C9, C10, C11	240 pF Chip Capacitors	ATC600F241JT250XT	ATC
C12, C15	22 μ F, 35 V Tantalum Capacitors	T491X226K035AT	Kemet
C13, C16, C19, C22	0.1 μ F Chip Capacitors	C0805C104K1RACTU	Kemet
C14, C17, C18, C21	0.01 μ F Chip Capacitors	C0805C103K5RACTU	Kemet
C20, C23	330 μ F, 35 V Electrolytic Capacitors	MCGPR35V337M10X16-RH	Multicomp
L1, L7, L8	5.5 nH Inductors	0806SQ5N5	Coilcraft
L2	12.3 nH Inductor	0806SQ12N	Coilcraft
L3, L4	22 nH Inductors	0807SQ22N	Coilcraft
L5	8.9 nH Inductor	0806SQ8N9	Coilcraft
R1	8.2 Ω , 1/3 W Chip Resistor	RL1220S-8R2-F	Susumu
R2	100 Ω , 1/4 W Chip Resistor	CRCW1206100RFKEA	Vishay
R3	1.0 Ω , 1/3 W Chip Resistor	RL1220S-1R0-F	Susumu
R4	75 Ω , 1/4 W Chip Resistor	SG73P2ATTD75R0F	KOA Speer
PCB	Rogers R04350B, 0.030", $\epsilon_r = 3.66$	D67108	MTL

TYPICAL CHARACTERISTICS — 520 MHz NARROWBAND TEST FIXTURE

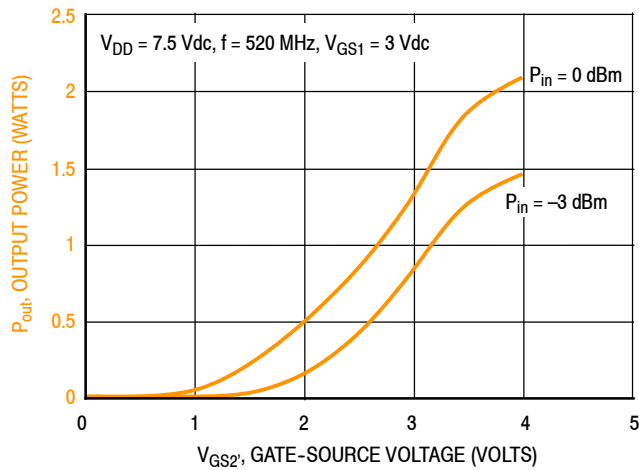

Figure 14. Output Power versus Gate-Source Voltage, 2nd Stage

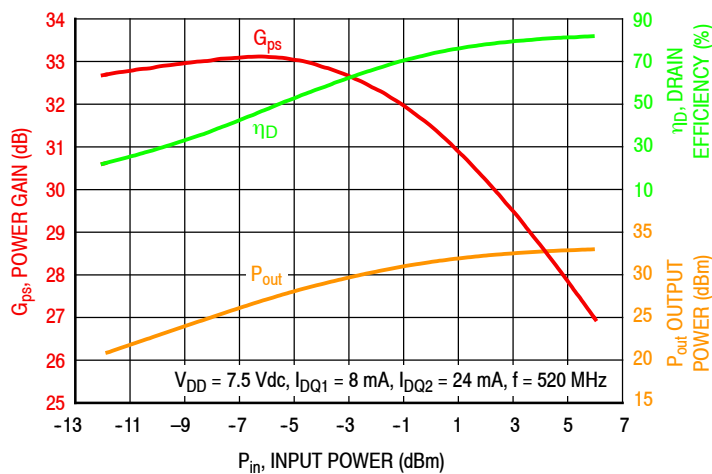

Figure 15. Power Gain, Drain Efficiency and Output Power versus Input Power

f MHz	Z _{source1} Ω	Z _{load1} Ω	Z _{source2} Ω	Z _{load2} Ω
520	50.3 + j30.9	84.4 + j93.6	3.5 + j17.8	12.3 + j11.4

Z_{source} = Test circuit impedance as measured from gate to gate.

Z_{load} = Test circuit impedance as measured from drain to drain.

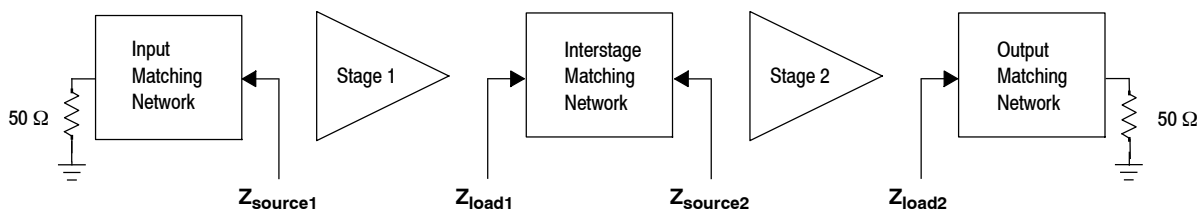

Figure 16. Narrowband Series Equivalent Source and Load Impedance — 520 MHz

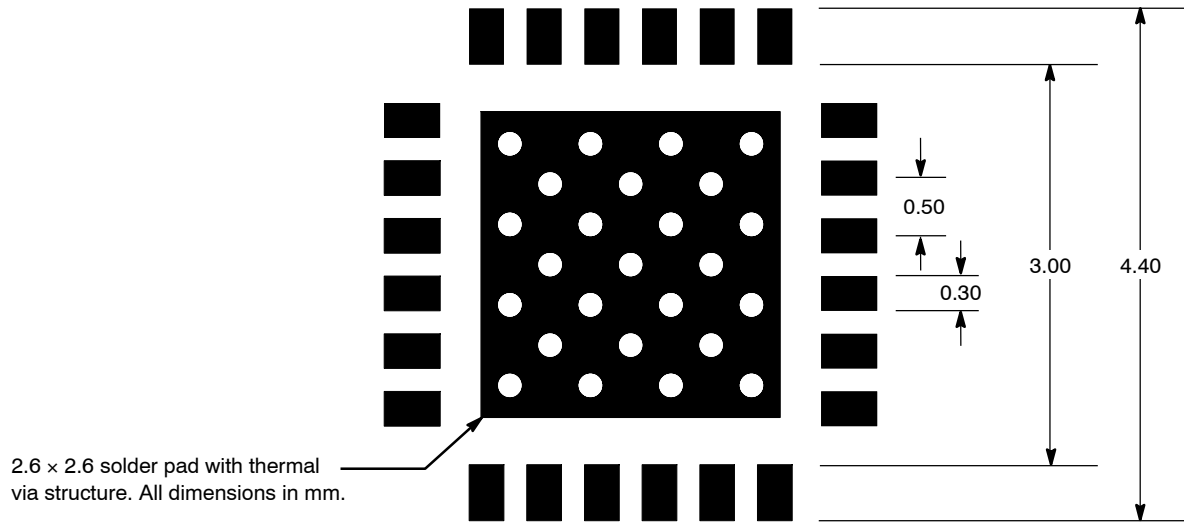

Figure 17. PCB Pad Layout for 24-Lead QFN 4 × 4

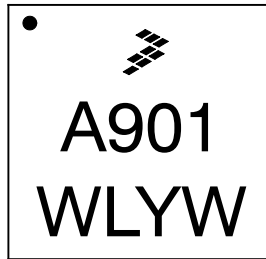
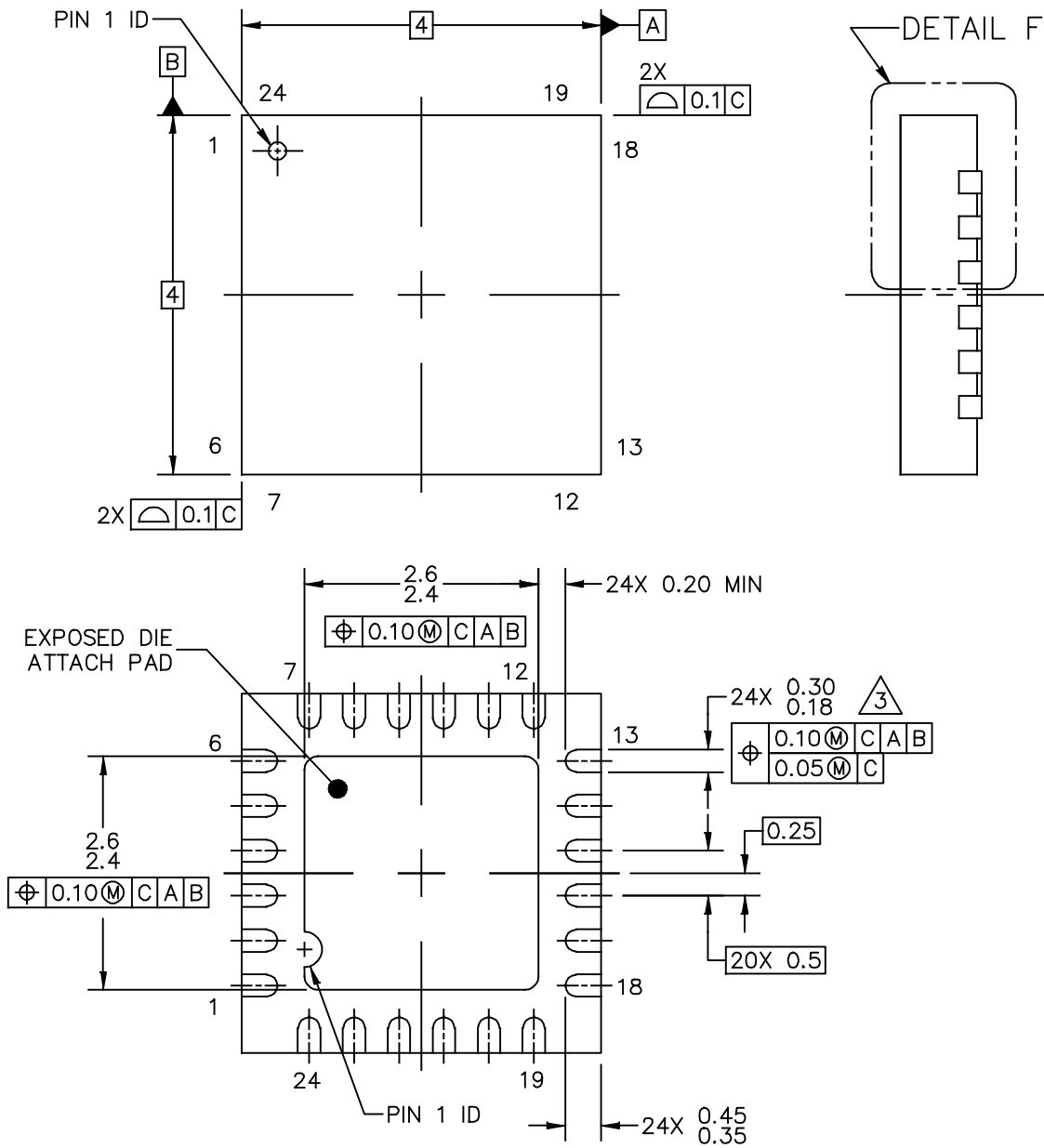
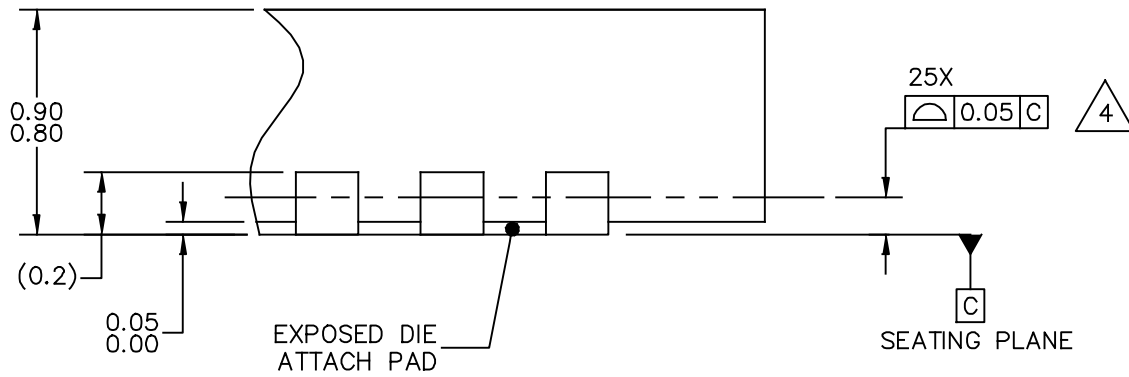

Figure 18. Product Marking

PACKAGE DIMENSIONS



© FREESCALE SEMICONDUCTOR, INC. ALL RIGHTS RESERVED.	MECHANICAL OUTLINE	PRINT VERSION NOT TO SCALE
TITLE: QFN (SAW), THERMALLY ENHANCED	DOCUMENT NO: 98ASA00651D	REV: 0
4 X 4 X 0.85, 0.5 PITCH, 24 TERMINAL	STANDARD: NON-JEDEC	
		20 NOV 2014



DETAIL F
VIEW ROTATED 90°CW

© FREESCALE SEMICONDUCTOR, INC. ALL RIGHTS RESERVED.	MECHANICAL OUTLINE	PRINT VERSION NOT TO SCALE
TITLE: QFN (SAW), THERMALLY ENHANCED 4 X 4 X 0.85, 0.5 PITCH, 24 TERMINAL	DOCUMENT NO: 98ASA00651D	REV: 0
	STANDARD: NON-JEDEC	
	20 NOV 2014	

NOTES:

1. ALL DIMENSIONS ARE IN MILLIMETERS.
2. DIMENSIONING AND TOLERANCING PER ASME Y14.5M-1994.
3. THIS DIMENSION APPLIES TO METALIZED TERMINAL AND IS MEASURED BETWEEN 0.15 AND 0.30 MM FROM TERMINAL TIP. THIS DIMENSION SHOULD NOT BE MEASURED IN THE RADIUS AREA ON THE OTHER END OF THE TERMINAL.
4. BILATERAL COPLANARITY ZONE APPLIES TO THE EXPOSED HEAT SINK SLUG AS WELL AS THE TERMINALS.

© FREESCALE SEMICONDUCTOR, INC. ALL RIGHTS RESERVED.	MECHANICAL OUTLINE	PRINT VERSION NOT TO SCALE	
TITLE: QFN (SAW), THERMALLY ENHANCED 4 X 4 X 0.85, 0.5 PITCH, 24 TERMINAL		DOCUMENT NO: 98ASA00651D	REV: 0
		STANDARD: NON-JEDEC	
		20 NOV 2014	

PRODUCT DOCUMENTATION, SOFTWARE AND TOOLS

Refer to the following resources to aid your design process.

Application Notes

- AN1955: Thermal Measurement Methodology of RF Power Amplifiers

Software

- .s2p File
- Electromigration MTTF Calculator
- RF High Power Model

Development Tools

- Printed Circuit Boards

To Download Resources Specific to a Given Part Number:

1. Go to <http://www.nxp.com/RF>
2. Search by part number
3. Click part number link
4. Choose the desired resource from the drop down menu

REVISION HISTORY

The following table summarizes revisions to this document.

Revision	Date	Description
0	Jan. 2016	• Initial Release of Data Sheet

How to Reach Us:

Home Page:
freescale.com

Web Support:
freescale.com/support

Information in this document is provided solely to enable system and software implementers to use Freescale products. There are no express or implied copyright licenses granted hereunder to design or fabricate any integrated circuits based on the information in this document.

Freescale reserves the right to make changes without further notice to any products herein. Freescale makes no warranty, representation, or guarantee regarding the suitability of its products for any particular purpose, nor does Freescale assume any liability arising out of the application or use of any product or circuit, and specifically disclaims any and all liability, including without limitation consequential or incidental damages. "Typical" parameters that may be provided in Freescale data sheets and/or specifications can and do vary in different applications, and actual performance may vary over time. All operating parameters, including "typicals," must be validated for each customer application by customer's technical experts. Freescale does not convey any license under its patent rights nor the rights of others. Freescale sells products pursuant to standard terms and conditions of sale, which can be found at the following address: freescale.com/SalesTermsandConditions.

Freescale and the Freescale logo are trademarks of Freescale Semiconductor, Inc., Reg. U.S. Pat. & Tm. Off. Airfast is a trademark of Freescale Semiconductor, Inc. All other product or service names are the property of their respective owners.

© 2016 Freescale Semiconductor, Inc.



Mouser Electronics

Authorized Distributor

Click to View Pricing, Inventory, Delivery & Lifecycle Information:

[NXP:](#)

[AFIC901NT1](#) [AFIC901N-760MHZ](#) [AFIC901N-135MHZ](#) [AFIC901N-350MHZ](#)