

ISL28233, ISL28433

Dual and Quad Micropower Chopper Stabilized, RRIO Operational Amplifiers

The [ISL28233](#) and [ISL28433](#) are dual and quad micropower, chopper stabilized operational amplifiers that are optimized for single and dual supply operation from 1.8V to 6.0V and $\pm 0.825V$ to $\pm 3.0V$. Their low supply current of $18\mu A$ and wide input range enable the ISL28233, ISL28433 to be excellent general purpose op amps for a wide range of applications. The ISL28233 and ISL28433 are ideal for handheld devices that operate off 2 AA or single Li-ion batteries.

The ISL28233 is available in 8 Ld MSOP, 8 Ld SOIC and 8 Ld DFN packages. The ISL28433 is available in 14 Ld TSSOP and 14 Ld SOIC packages. All devices operate over the temperature range of $-40^{\circ}C$ to $+125^{\circ}C$.

Features

- Low Input Offset Voltage..... $6\mu V$, Max.
- Low Offset Drift $0.05\mu V/^{\circ}C$, Max.
- Quiescent Current (Per Amplifier) $18\mu A$, Typ.
- Single Supply Range $+1.8V$ to $+6.0V$
- Dual Supply Range $\pm 0.825V$ to $\pm 3.0V$
- Low Noise (0.01Hz to 10Hz) $1.0\mu V_{p-p}$, Typ.
- Rail-to-Rail Inputs and Output
- Input Bias Current $180pA$, Max.
- Operating Temperature Range..... $-40^{\circ}C$ to $+125^{\circ}C$

Applications

- Bi-Directional Current Sense
- Temperature Measurement
- Medical Equipment
- Electronic Weigh Scales
- Precision/Strain Gauge Sensor
- Precision Regulation
- Low Ohmic Current Sense
- High Gain Analog Front Ends

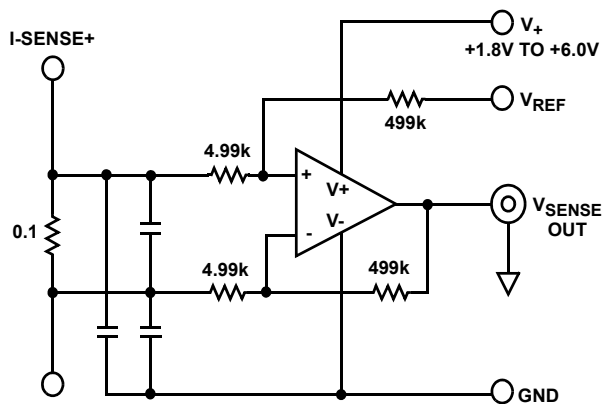

BI-DIRECTIONAL CURRENT SENSE AMPLIFIER

FIGURE 1. TYPICAL APPLICATION

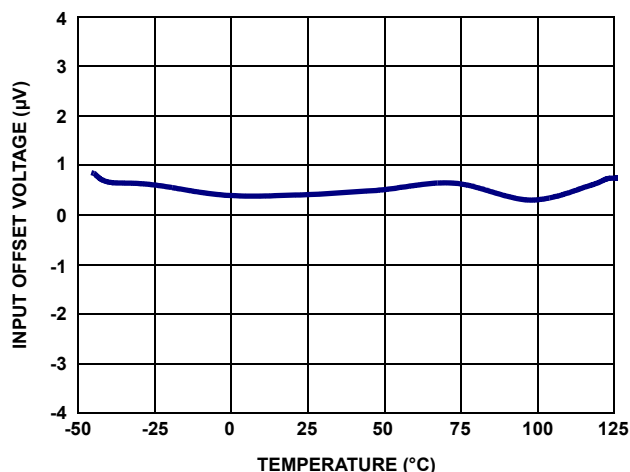

FIGURE 2. V_{OS} vs TEMPERATURE

Ordering Information

PART NUMBER (Notes 2, 3)	PART MARKING	PACKAGE DESCRIPTION (RoHS Compliant)	PKG. DWG. #	CARRIER TYPE (Note 1)	TEMP RANGE
ISL28233FUZ	233FZ	8 Ld MSOP	M8.118A	Tube	-40 °C to +125 °C
ISL28233FUZ-T7				Reel, 1.5k	
ISL28233FUZ-T7A				Reel, 250	
ISL28233FRZ	233Z	8 Ld 3mmx3mm DFN	L8.3x3J	Tube	
ISL28233FRZ-T7				Reel, 1k	
ISL28233FRZ-T13				Reel, 2.5k	
ISL28233FBZ	28233 FBZ	8 Ld SOIC	M8.15E	Tube	
ISL28233FBZ-T7				Reel, 1k	
ISL28233FBZ-T7A				Reel, 250	
ISL28433FBZ	28433 FBZ	14 Ld SOIC	MDP0027	Tube	
ISL28433FBZ-T7				Reel, 1k	
ISL28433FBZ-T7A				Reel, 250	
ISL28433FVZ	28433 FVZ	14 Ld TSSOP	MDP0044	Tube	
ISL28433FVZ-T13				Reel, 2.5k	
ISL28233SOICEVAL1Z	ISL28233 Evaluation Board				
ISL28433TSSOPEVAL1Z	ISL28433 Evaluation Board TSSOP package				
ISL28433SOICEVAL1Z	ISL28433 Evaluation Board SOIC package				

NOTES:

1. Refer to [TB347](#) for details on reel specifications.
2. These Pb-free plastic packaged products employ special Pb-free material sets, molding compounds/die attach materials, and 100% matte tin plate plus anneal (e3 termination finish, which is RoHS compliant and compatible with both SnPb and Pb-free soldering operations). Pb-free products are MSL classified at Pb-free peak reflow temperatures that meet or exceed the Pb-free requirements of IPC/JEDEC J STD-020.
3. For Moisture Sensitivity Level (MSL), please see device information page for [ISL28233](#), [ISL28433](#). For more information on MSL please see techbrief [TB363](#).

Pin Configurations

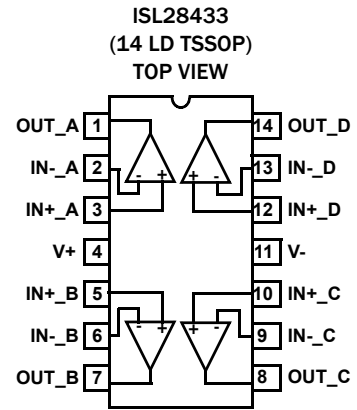
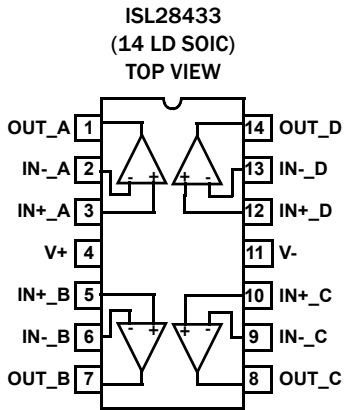
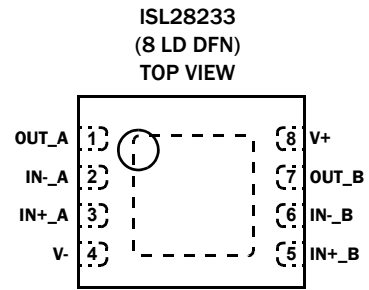
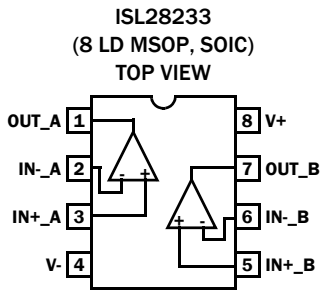

Pin Descriptions

ISL28233 (8 LD MSOP, SOIC, DFN)	ISL28433 (14 LD TSSOP, SOIC)	PIN NAME	FUNCTION	EQUIVALENT CIRCUIT
3	3	IN+_A	Non-inverting input	<p>Circuit 1</p>
5	5	IN+_B		
-	10	IN+_C		
-	12	IN+_D		
4	11	V-	Negative supply	
2	2	IN-_A	Inverting input	(See Circuit 1)
6	6	IN-_B		
-	9	IN-_C		
-	13	IN-_D		
1	1	OUT_A	Output	<p>Circuit 2</p>
7	7	OUT_B		
-	8	OUT_C		
-	14	OUT_D		
8	4	V+	Positive supply	
-	-	PAD	Thermal Pad	Thermal Pad. Connect to most negative supply. DFN package only.

Absolute Maximum Ratings

Max Supply Voltage V+ to V-	6.5V
Max Voltage VIN to GND	(V- - 0.3V) to (V+ + 0.3V)V
Max Input Differential Voltage	6.5V
Max Input Current	20mA
Max Voltage VOUT to GND (10s)	±3.0V
ESD Tolerance	
Human Body Model (Tested per JESD22-A114F)	4000V
Machine Model (Tested per JESD22-A115B)	400V
Charged Device Model (Tested per JESD22-C110D)	2000V
Latch-Up (Tested per JESD78B)	+125°C

Thermal Information

Thermal Resistance (Typical)	θ_{JA} (°C/W)	θ_{JC} (°C/W)
14 Ld TSSOP (Notes 4, 7)	110	40
14 Ld SOIC (Notes 4, 7)	75	47
8 Ld MSOP (Notes 4, 7)	180	65
8 Ld SOIC (Notes 4, 7)	125	90
8 Ld DFN (Notes 5, 6)	53	12
Maximum Storage Temperature Range	-65°C to +150°C	
Pb-Free Reflow Profile	see TB493	

Operating Conditions

Temperature Range -40°C to +125°C

CAUTION: Do not operate at or near the maximum ratings listed for extended periods of time. Exposure to such conditions may adversely impact product reliability and result in failures not covered by warranty.

NOTES:

- θ_{JA} is measured with the component mounted on a high effective thermal conductivity test board in free air. See [TB379](#) for details.
- θ_{JA} is measured in free air with the component mounted on a high effective thermal conductivity test board with "direct attach" features. See [TB379](#).
- For θ_{JC} , the "case temp" location is the center of the exposed metal pad on the package underside.
- For θ_{JC} , the "case temp" location is taken at the package top center.

Electrical Specifications V+ = 5V, V- = 0V, V_{CM} = 2.5V, T_A = +25°C, R_L = 10k Ω , unless otherwise specified. **Boldface limits apply over the operating temperature range, -40°C to +125°C.**

PARAMETER	DESCRIPTION	CONDITIONS	MIN (Note 8)	TYP	MAX (Note 8)	UNIT
DC SPECIFICATIONS						
V _{OS}	Input Offset Voltage		-6	±2	6	μ V
		T = -40°C to +125°C	-11	-	11	μ V
TCV _{OS}	Input Offset Voltage Temperature Coefficient	T = -40°C to +125°C	-0.05	0.01	0.05	μ V/°C
I _{OS}	Input Offset Current		-	10	-	pA
TCI _{OS}	Input Offset Current Temperature Coefficient	T = -40°C to +85°C	-	0.11	-	pA/°C
I _B	Input Bias Current	T = -40°C to +85°C	-180	-	180	pA
		T = -40°C to +125°C	-600	-	600	pA
TCI _B	Input Bias Current Temperature Coefficient	T = -40°C to +85°C	-	0.49	-	pA/°C
CMIR		V+ = 5.0V, V- = 0V Guaranteed by CMRR	-0.1	-	5.1	V
CMRR	Common Mode Rejection Ratio	V _{CM} = -0.1V to 5.1V	118	125	-	dB
			115	-	-	dB
PSRR	Power Supply Rejection Ratio	V _S = 1.8V to 6.0V	110	138	-	dB
			110	-	-	dB
V _{OH}	Output Voltage, High		4.965	4.981	-	V
V _{OL}	Output Voltage, Low		-	18	35	mV
A _{OL}	Open Loop Gain	R _L = 1M Ω	-	174	-	dB
V+	Supply Voltage	Guaranteed by PSRR	1.8	-	6.0	V
I _S	Supply Current, Per Amplifier	R _L = OPEN	-	18	25	μ A
			-	-	35	μ A
I _{SC+}	Output Source Short Circuit Current	R _L = Short to V-	13	17	26	mA
I _{SC-}	Output Sink Short Circuit Current	R _L = Short to V+	-26	-19	-13	mA

Electrical Specifications $V_+ = 5V, V_- = 0V, V_{CM} = 2.5V, T_A = +25^\circ C, R_L = 10k\Omega$, unless otherwise specified. **Boldface limits apply over the operating temperature range, -40°C to +125°C. (Continued)**

PARAMETER	DESCRIPTION	CONDITIONS	MIN (Note 8)	TYP	MAX (Note 8)	UNIT
AC SPECIFICATIONS						
GBWP	Gain Bandwidth Product	$A_V = 100, R_F = 100k\Omega, R_G = 1k\Omega, R_L = 10k\Omega$ to V_{CM}	-	400	-	kHz
$e_N V_{P-P}$	Peak-to-Peak Input Noise Voltage	$f = 0.01Hz$ to 10Hz	-	1.0	-	μV_{P-P}
e_N	Input Noise Voltage Density	$f = 1kHz$	-	65	-	nV/\sqrt{Hz}
i_N	Input Noise Current Density	$f = 1kHz$	-	72	-	fA/\sqrt{Hz}
		$f = 10Hz$	-	79	-	fA/\sqrt{Hz}
C_{in}	Differential Input Capacitance	$f = 1MHz$	-	1.6	-	pF
	Common Mode Input Capacitance		-	1.12	-	pF
TRANSIENT RESPONSE						
SR	Positive Slew Rate	$V_{OUT} = 1V$ to 4V, $R_L = 10k\Omega$	-	0.2	-	V/ μs
	Negative Slew Rate		-	0.1	-	V/ μs
t_r, t_f , Small Signal	Rise Time, t_r 10% to 90%	$A_V = +1, V_{OUT} = 0.1V_{P-P}, R_F = 0\Omega, R_L = 10k\Omega, C_L = 1.2pF$	-	1.1	-	μs
	Fall Time, t_f 10% to 90%		-	1.1	-	μs
t_r, t_f Large Signal	Rise Time, t_r 10% to 90%	$A_V = +1, V_{OUT} = 2V_{P-P}, R_F = 0\Omega, R_L = 10k\Omega, C_L = 1.2pF$	-	20	-	μs
	Fall Time, t_f 10% to 90%		-	30	-	μs
t_s	Settling Time to 0.1%, 2V _{P-P} Step	$A_V = +1, R_F = 0\Omega, R_L = 10k\Omega, C_L = 1.2pF$	-	35	-	μs
$t_{recover}$	Output Overload Recovery Time, Recovery to 90% of output saturation	$A_V = +2, R_F = 10k\Omega, R_L = Open, C_L = 3.7pF$	-	10.5	-	μs

NOTE:

8. Compliance to datasheet limits is assured by one or more methods: production test, characterization and/or design.

Typical Performance Curves

$V_+ = 5V, V_- = 0V, V_{CM} = 2.5V, R_L = Open, T = +25^\circ C$, unless otherwise specified.

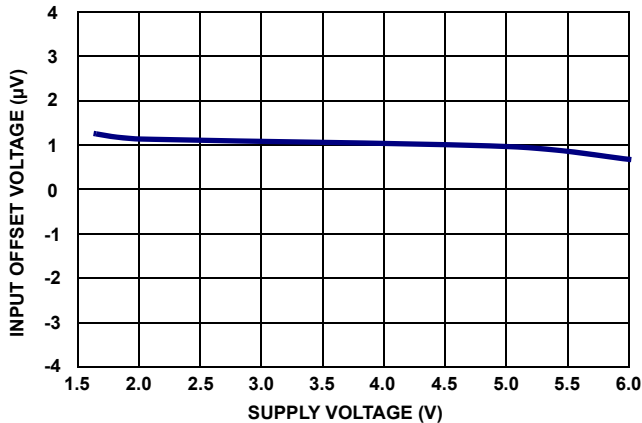

FIGURE 3. V_{OS} vs SUPPLY VOLTAGE

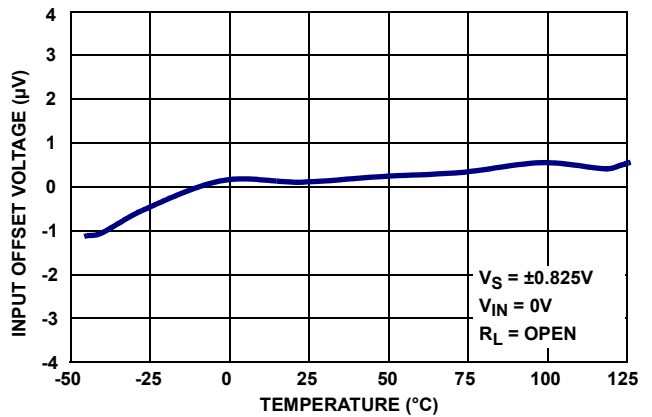

FIGURE 4. V_{OS} vs TEMPERATURE

V+ = 5V, V- = 0V, V_{CM} = 2.5V, R_L = Open, T = +25 °C, unless otherwise specified. (Continued)

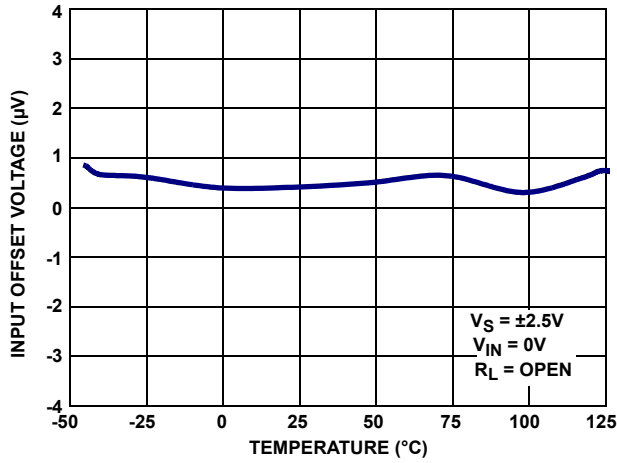

FIGURE 5. V_{OS} vs TEMPERATURE

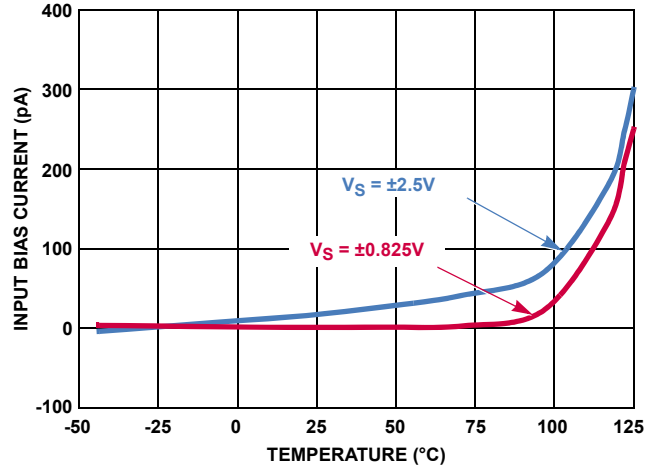

FIGURE 6. I_{B+} vs TEMPERATURE

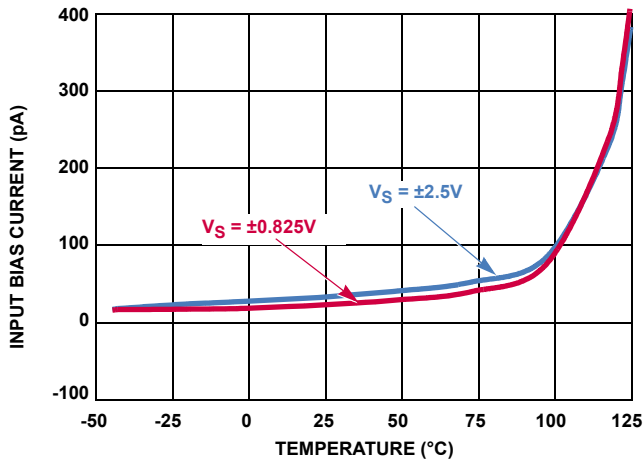

FIGURE 7. I_{B-} vs TEMPERATURE

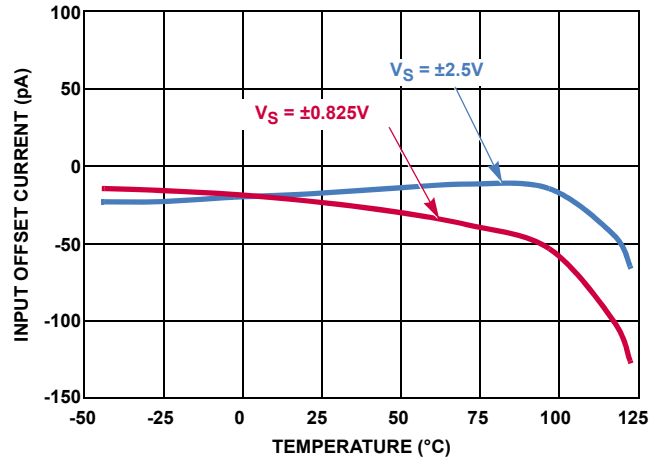

FIGURE 8. I_{OS} vs TEMPERATURE

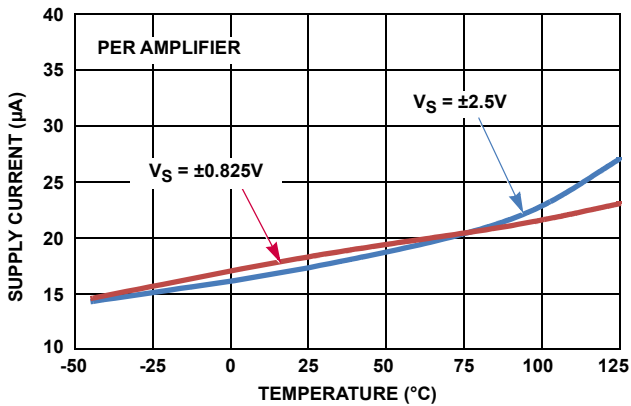

FIGURE 9. SUPPLY CURRENT vs TEMPERATURE

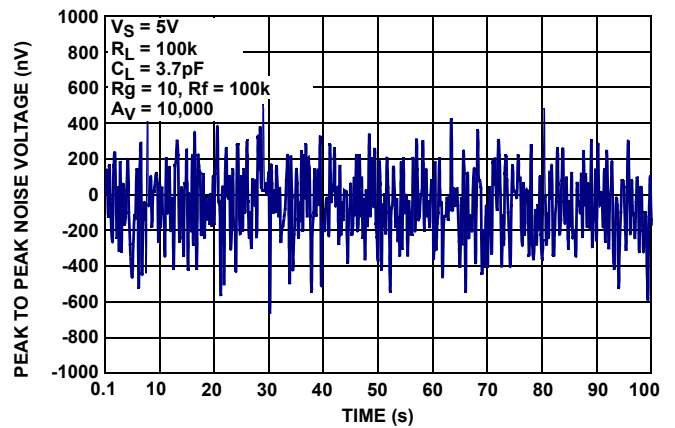

FIGURE 10. INPUT NOISE VOLTAGE 0.01Hz TO 10Hz

$V_+ = 5V$, $V_- = 0V$, $V_{CM} = 2.5V$, $R_L = \text{Open}$, $T = +25^\circ\text{C}$, unless otherwise specified. (Continued)

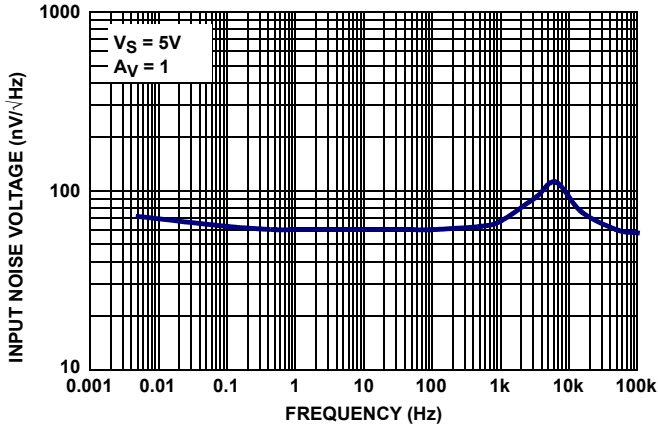

FIGURE 11. INPUT NOISE VOLTAGE DENSITY vs FREQUENCY

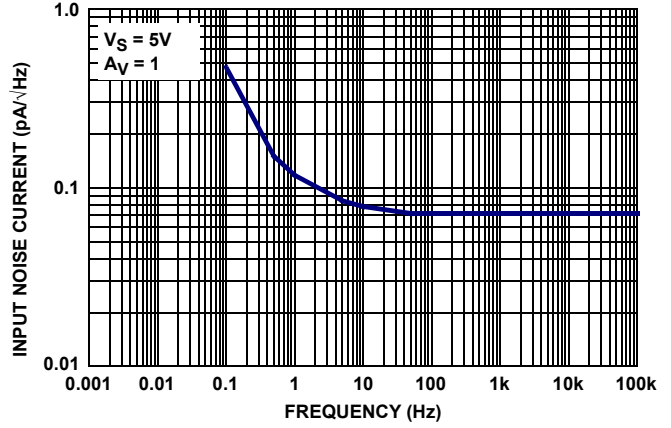

FIGURE 12. INPUT NOISE CURRENT DENSITY vs FREQUENCY

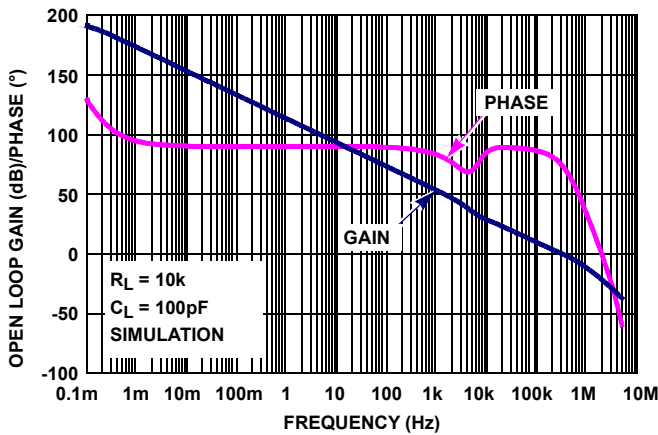

FIGURE 13. FREQUENCY RESPONSE vs OPEN LOOP GAIN, $R_L = 10k\Omega$

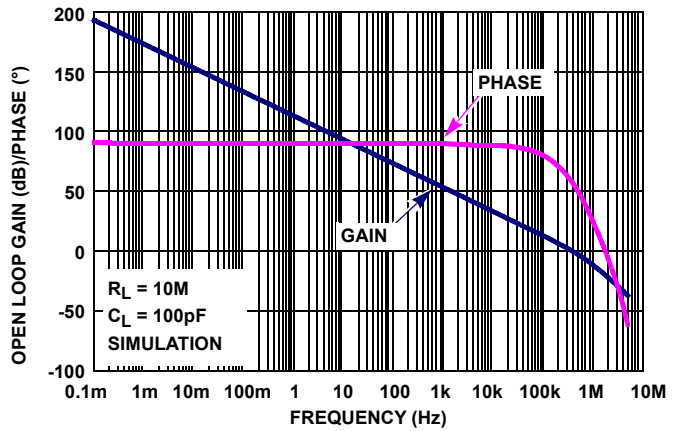

FIGURE 14. FREQUENCY RESPONSE vs OPEN LOOP GAIN, $R_L = 10M\Omega$

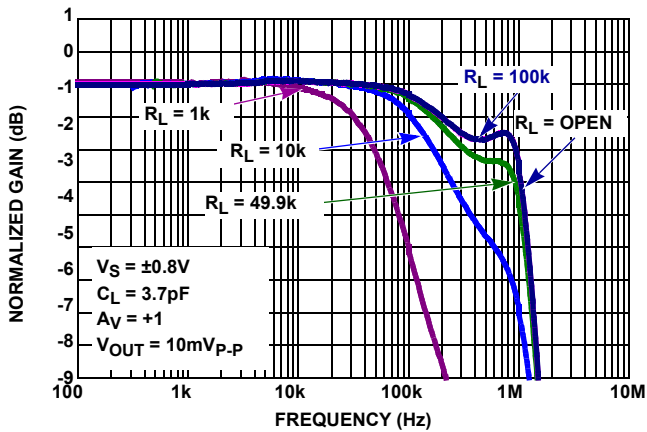

FIGURE 15. GAIN vs FREQUENCY vs R_L , $V_S = \pm 0.8V$

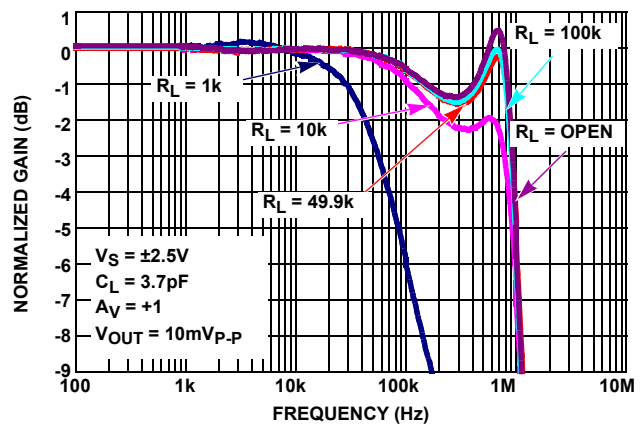

FIGURE 16. GAIN vs FREQUENCY vs R_L , $V_S = \pm 2.5V$

$V_+ = 5V$, $V_- = 0V$, $V_{CM} = 2.5V$, $R_L = \text{Open}$, $T = +25^\circ C$, unless otherwise specified. (Continued)

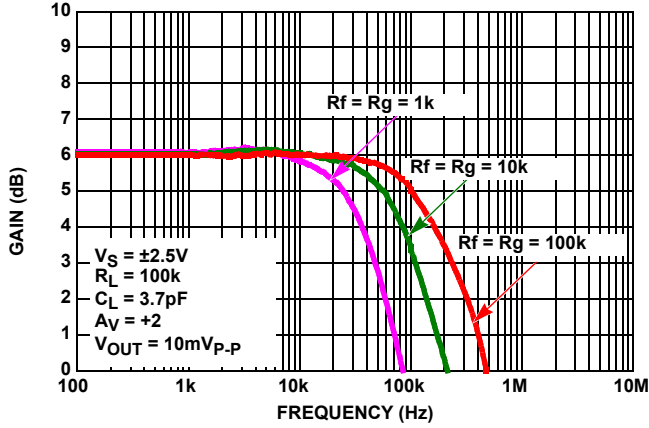

FIGURE 17. GAIN vs FREQUENCY vs FEEDBACK RESISTOR VALUES R_f/R_g

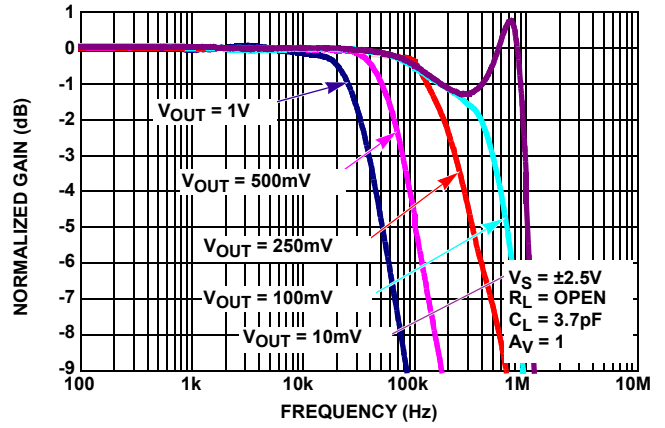

FIGURE 18. GAIN vs FREQUENCY vs V_{OUT} , $R_L = \text{OPEN}$

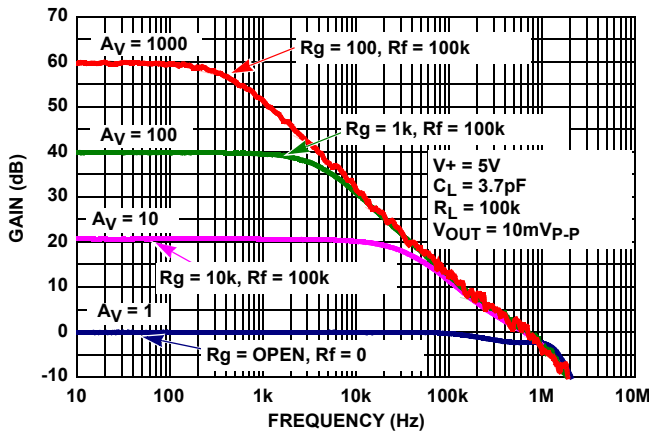

FIGURE 19. FREQUENCY RESPONSE vs CLOSED LOOP GAIN

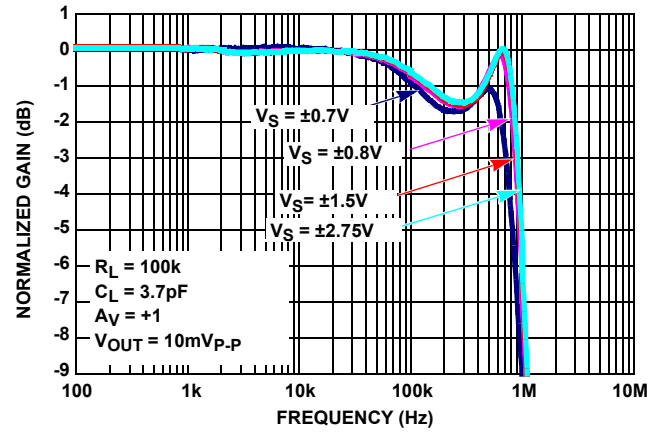

FIGURE 20. GAIN vs FREQUENCY vs SUPPLY VOLTAGE

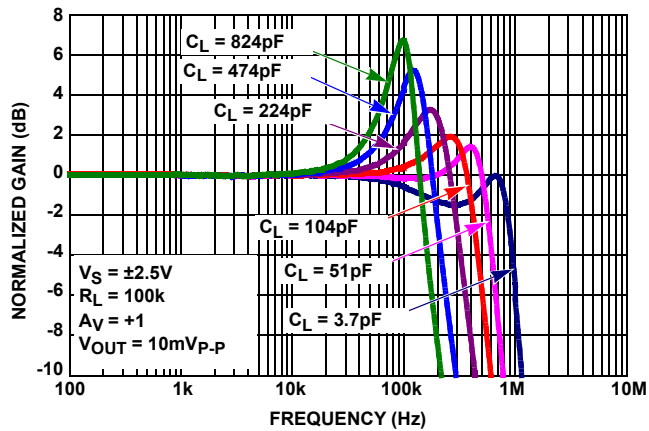

FIGURE 21. GAIN vs FREQUENCY vs C_L

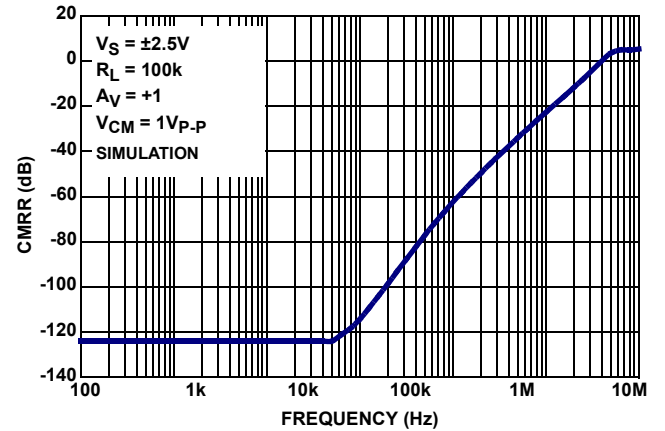

FIGURE 22. CMRR vs FREQUENCY, $V_S = \pm 2.5V$

V+ = 5V, V- = 0V, V_{CM} = 2.5V, R_L = Open, T = +25 °C, unless otherwise specified. (Continued)

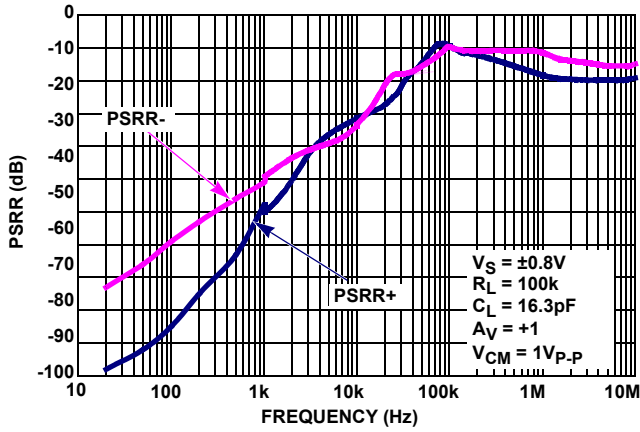

FIGURE 23. PSRR vs FREQUENCY, $V_S = \pm 0.8V$

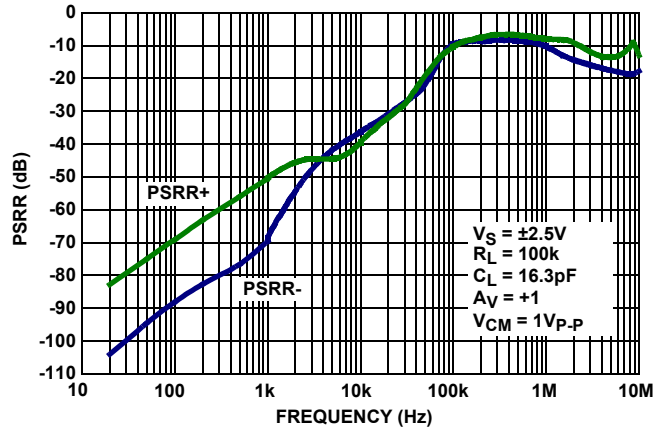

FIGURE 24. PSRR vs FREQUENCY, $V_S = \pm 2.5V$

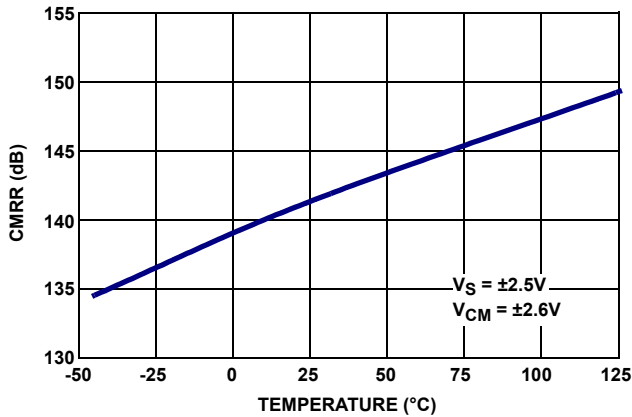

FIGURE 25. CMRR vs TEMPERATURE

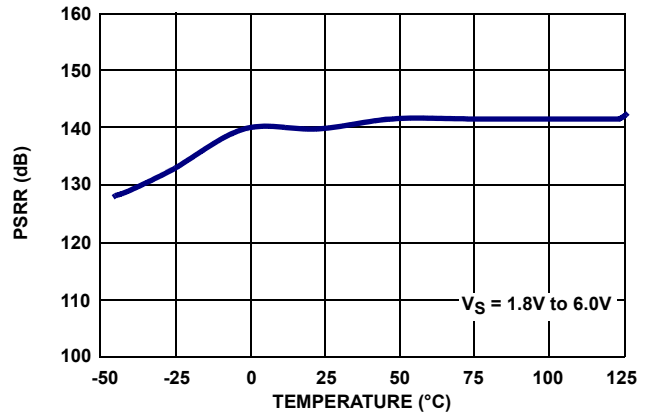

FIGURE 26. PSRR vs TEMPERATURE

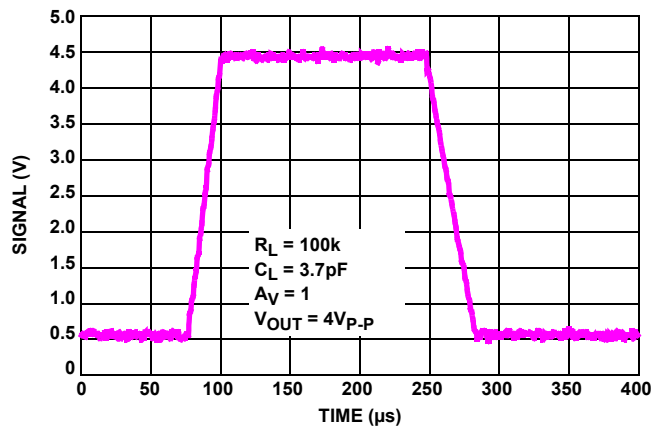

FIGURE 27. LARGE SIGNAL STEP RESPONSE (4V)

$V_+ = 5V$, $V_- = 0V$, $V_{CM} = 2.5V$, $R_L = \text{Open}$, $T = +25^\circ C$, unless otherwise specified. (Continued)

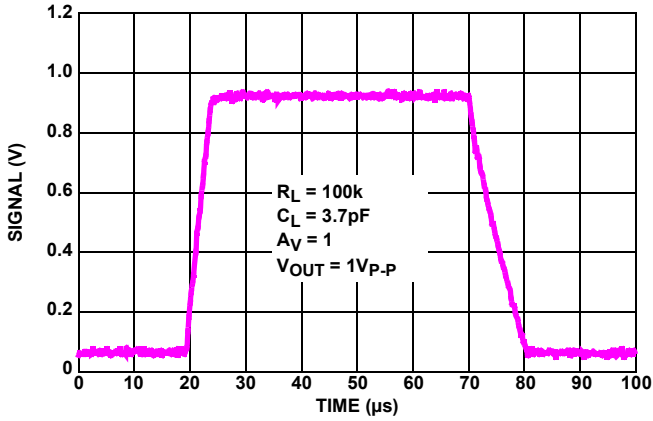

FIGURE 28. LARGE SIGNAL STEP RESPONSE (1V)

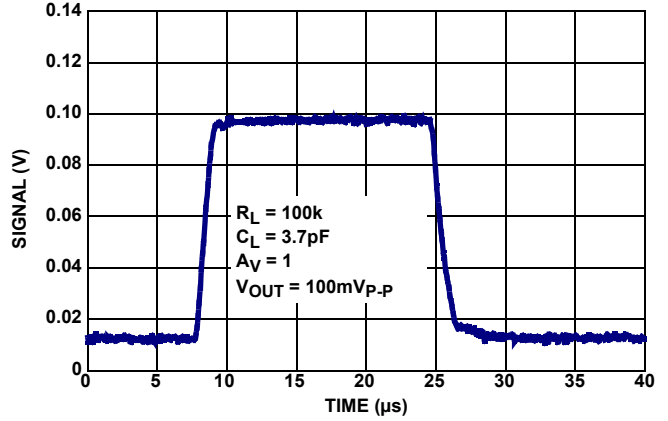

FIGURE 29. SMALL SIGNAL STEP RESPONSE (100mV)

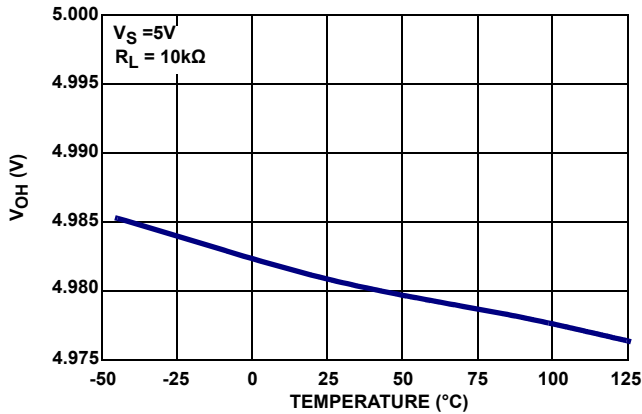

FIGURE 30. V_{OH} vs TEMPERATURE

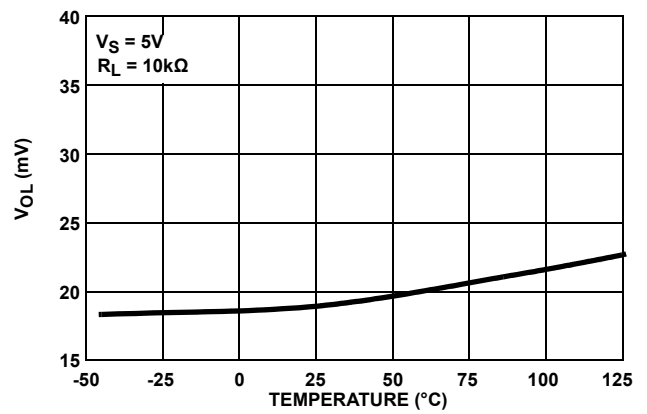

FIGURE 31. V_{OL} vs TEMPERATURE

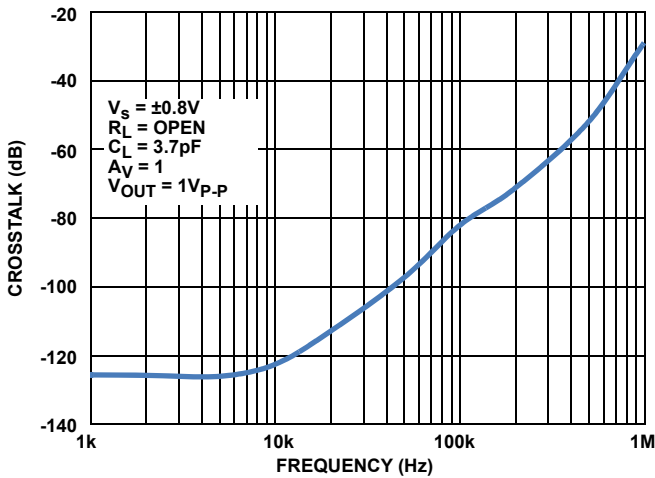

FIGURE 32. CROSSTALK vs FREQUENCY, $V_S = \pm 0.8V$

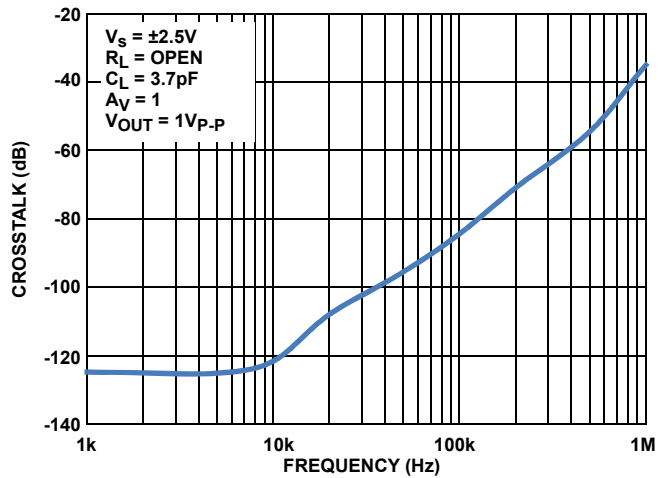

FIGURE 33. CROSSTALK vs FREQUENCY, $V_S = \pm 2.5V$

$V_+ = 5V$, $V_- = 0V$, $V_{CM} = 2.5V$, $R_L = \text{Open}$, $T = +25^\circ\text{C}$, unless otherwise specified. (Continued)

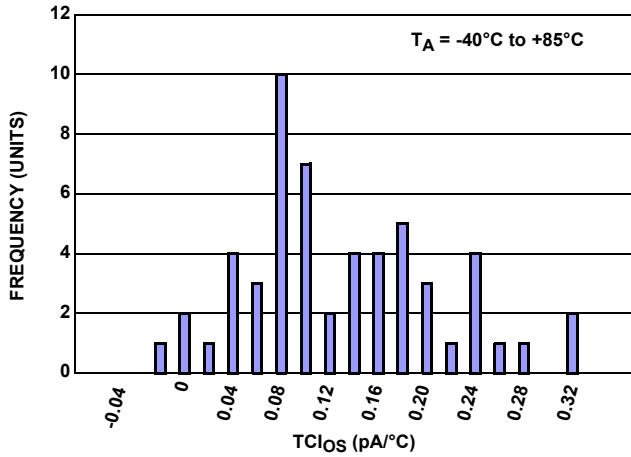

FIGURE 34. TCI_{OS} HISTOGRAM

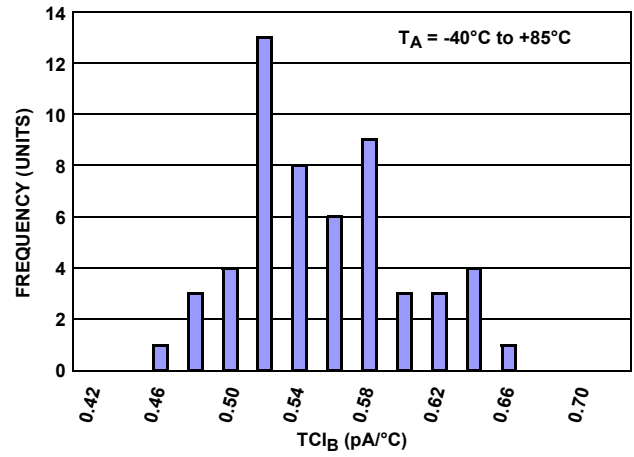

FIGURE 35. TCI_B HISTOGRAM

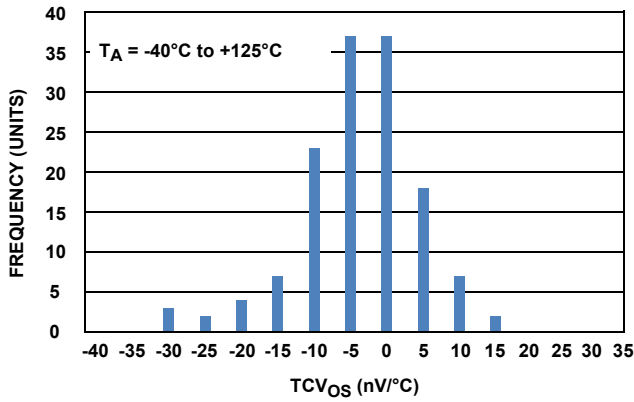

FIGURE 36. TCV_{OS} HISTOGRAM

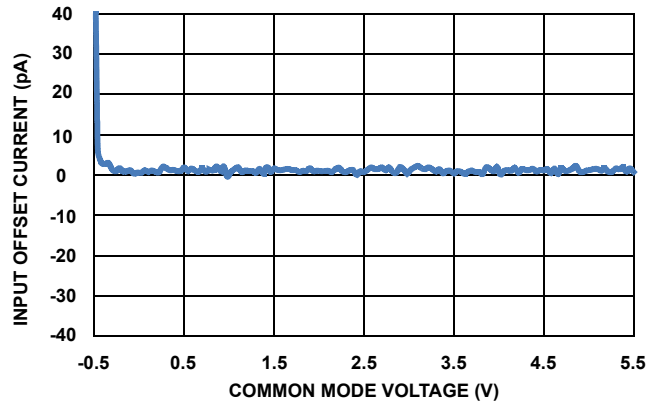

FIGURE 37. I_{OS} vs V_{CM}

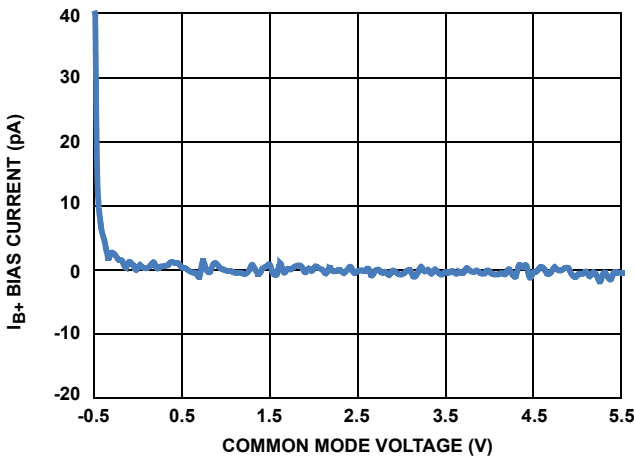

FIGURE 38. I_{B+} vs V_{CM}

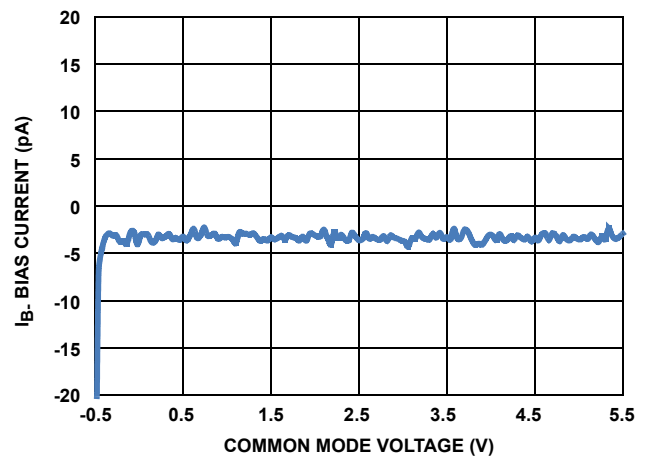

FIGURE 39. I_{B-} vs V_{CM}

$V_+ = 5V$, $V_- = 0V$, $V_{CM} = 2.5V$, $R_L = \text{Open}$, $T = +25^\circ\text{C}$, unless otherwise specified. (Continued)

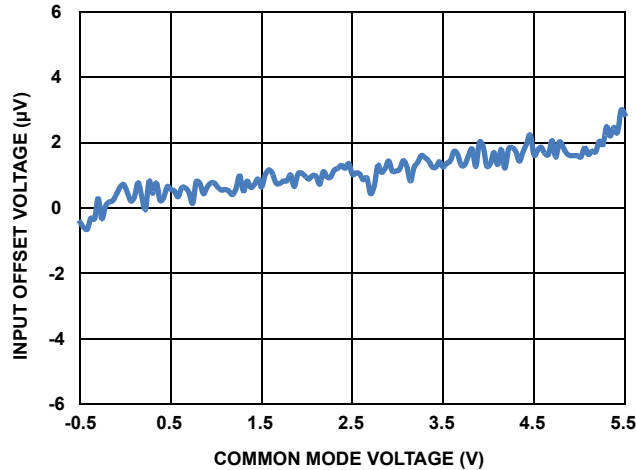

FIGURE 40. V_{OS} vs V_{CM}

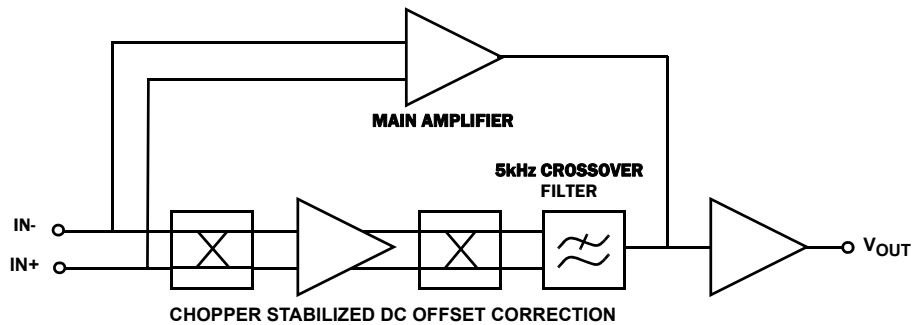

FIGURE 41. ISL28233, ISL28433 FUNCTIONAL BLOCK DIAGRAM

Applications Information

Functional Description

The ISL28233 and ISL28433 use a proprietary chopper-stabilized technique (see Figure 41) that combines a 400kHz main amplifier with a very high open loop gain (174dB) chopper amplifier to achieve very low offset voltage and drift ($2\mu\text{V}$, $0.01\mu\text{V}/^\circ\text{C}$ typical) while consuming only $18\mu\text{A}$ of supply current per channel.

This multi-path amplifier architecture contains a time continuous main amplifier whose input DC offset is corrected by a parallel-connected, high gain chopper stabilized DC correction amplifier operating at 100kHz. From DC to $\sim 5\text{kHz}$, both amplifiers are active with DC offset correction and most of the low frequency gain is provided by the chopper amplifier. A 5kHz crossover filter cuts off the low frequency amplifier path leaving the main amplifier active out to the 400kHz gain-bandwidth product of the device.

The key benefits of this architecture for precision applications are very high open loop gain, very low DC offset, and low $1/f$ noise. The noise is virtually flat across the frequency range from a few millihertz out to 100kHz, except for the narrow noise peak at the amplifier crossover frequency (5kHz).

Rail-to-rail Input and Output (RRIO)

The RRIO CMOS amplifier uses parallel input PMOS and NMOS that enable the inputs to swing 100mV beyond either supply rail. The inverting and non-inverting inputs do not have back-to-back input clamp diodes and are capable of maintaining high input impedance at high differential input voltages. This is effective in eliminating output distortion caused by high slew-rate input signals.

The output stage uses common source connected PMOS and NMOS devices to achieve rail-to-rail output drive capability with 17mA current limit and the capability to swing to within 20mV of either rail while driving a $10\text{k}\Omega$ load.

IN+ and IN- Protection

All input terminals have internal ESD protection diodes to both positive and negative supply rails, limiting the input voltage to within one diode beyond the supply rails. For applications where either input is expected to exceed the rails by 0.5V, an external series resistor must be used to ensure the input currents never exceed 20mA (see Figure 42).

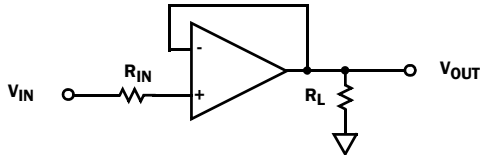

FIGURE 42. INPUT CURRENT LIMITING

Layout Guidelines for High Impedance Inputs

To achieve the maximum performance of the high input impedance and low offset voltage of the ISL28233 and ISL28433 amplifiers, care should be taken in the circuit board layout. The PC board surface must remain clean and free of moisture to avoid leakage currents between adjacent traces. Surface coating of the circuit board will reduce surface moisture and provide a humidity barrier, reducing parasitic resistance on the board.

High Gain, Precision DC-Coupled Amplifier

The circuit in Figure 43 implements a single-stage DC-coupled amplifier with an input DC sensitivity of under 100nV that is only possible using a low V_{OS} amplifier with high open loop gain. High gain DC amplifiers operating from low voltage supplies are not practical using typical low offset precision op amps. For example, a typical precision amplifier in a gain of 10kV/V with a $\pm 100\mu\text{V}$ V_{OS} and offset drift 0.5 $\mu\text{V}/^\circ\text{C}$ of a low offset op amp would produce a DC error of >1V with an additional 5mV/ $^\circ\text{C}$ of temperature dependent error making it difficult to resolve DC input voltage changes in the mV range.

The $\pm 6\mu\text{V}$ max V_{OS} and 0.05 $\mu\text{V}/^\circ\text{C}$ max temperature drift of the ISL28233, ISL28433 produces a temperature stable maximum DC output error of only $\pm 60\text{mV}$ with a maximum output temperature drift of 0.5mV/ $^\circ\text{C}$. The additional benefit of a very low 1/f noise corner frequency and some feedback filtering enables DC voltages and voltage fluctuations well below 100nV to be easily detected with a simple single stage amplifier.

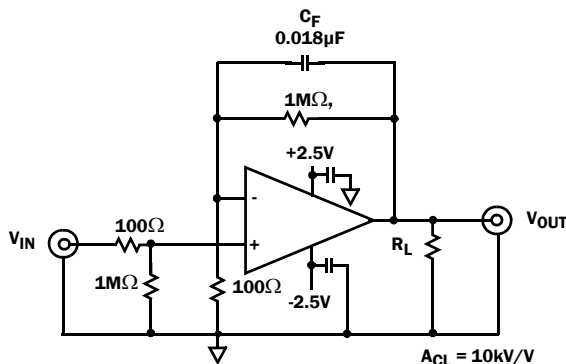

FIGURE 43. HIGH GAIN, PRECISION DC-COUPLED AMPLIFIER

ISL28233, ISL28433 SPICE Model

Figure 44 shows the SPICE model schematic and Figure 45 shows the net list for the ISL28233, ISL28433 SPICE model. The model is a simplified version of the actual device and simulates important parameters such as noise, Slew Rate, Gain and Phase. The model uses typical parameters from the “Electrical Specifications Table” on page 5. The poles and zeroes in the model were determined from the actual open and closed-loop gain and phase response. This enables the model to present an accurate AC representation of the actual device. The model is configured for ambient temperature of +25 $^\circ\text{C}$.

Figures 46 through 53 show the characterization vs simulation results for the Noise Density, Frequency Response vs Close Loop Gain, Gain vs Frequency vs C_L and Large Signal Step Response (4V).

LICENSE STATEMENT

The information in this SPICE model is protected under the United States copyright laws. Renesas Corporation hereby grants users of this macro-model hereto referred to as “Licensee”, a nonexclusive, nontransferable licence to use this model as long as the Licensee abides by the terms of this agreement. Before using this macro-model, the Licensee should read this license. If the Licensee does not accept these terms, permission to use the model is not granted.

The Licensee may not sell, loan, rent, or license the macro-model, in whole, in part, or in modified form, to anyone outside the Licensee’s company. The Licensee may modify the macro-model to suit his/her specific applications, and the Licensee may make copies of this macro-model for use within their company only.

This macro-model is provided “AS IS, WHERE IS, AND WITH NO WARRANTY OF ANY KIND EITHER EXPRESSED OR IMPLIED, INCLUDING BUY NOT LIMITED TO ANY IMPLIED WARRANTIES OF MERCHANTABILITY AND FITNESS FOR A PARTICULAR PURPOSE.”

In no event will Renesas be liable for special, collateral, incidental, or consequential damages in connection with or arising out of the use of this macro-model. Renesas reserves the right to make changes to the product and the macro-model without prior notice.

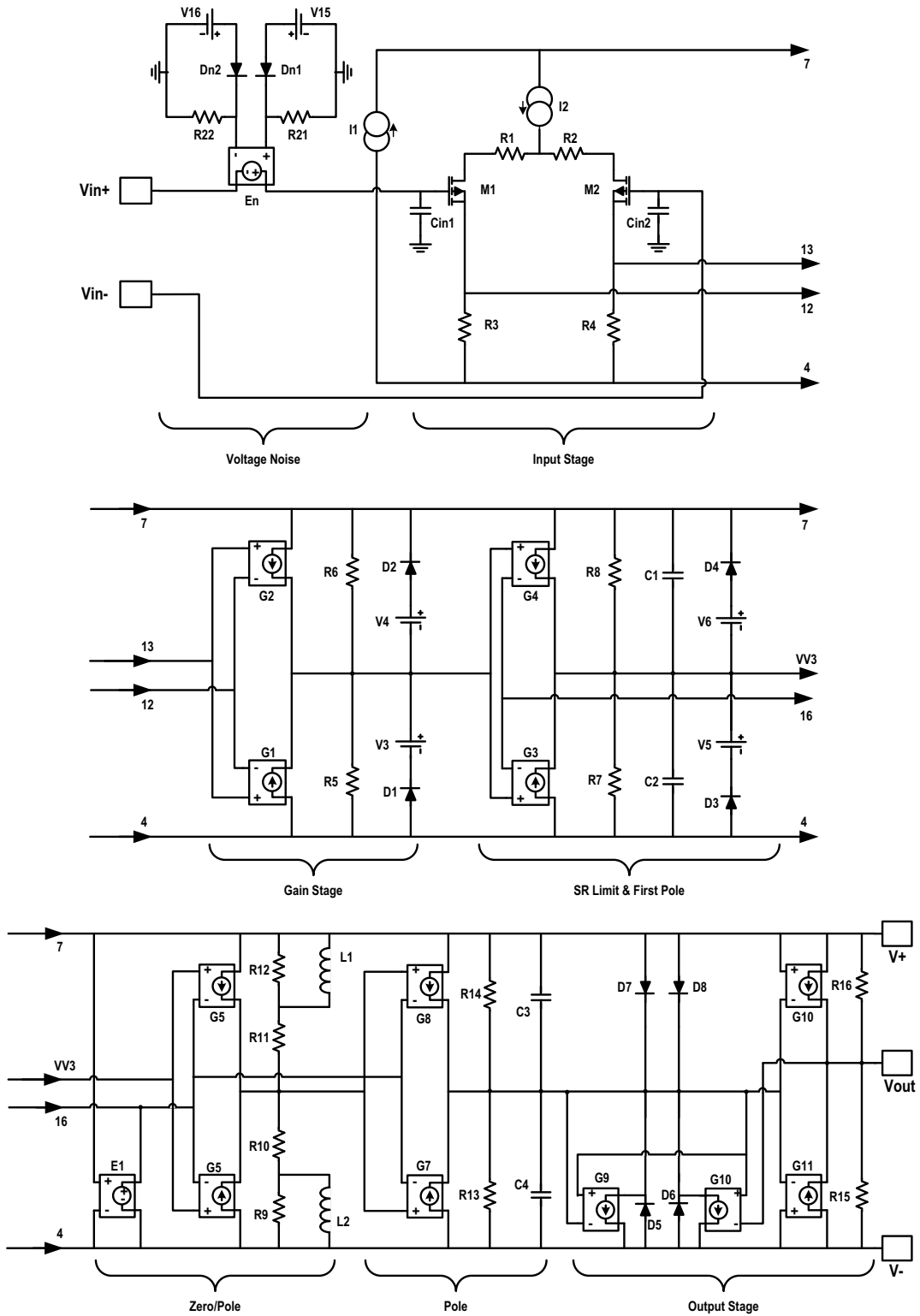

FIGURE 44. SPICE CIRCUIT SCHEMATIC

```

* ISL28233, ISL28433 Macromodel
* Revision B, April 2009
* AC characteristics, Voltage Noise
*Copyright 2009 by Renesas Corporation
*Refer to data sheet "LICENSE STATEMENT" Use of
*this model indicates your acceptance with the
*terms and provisions in the License Statement.
* Connections:      +input
*                   |      -input
*                   |      |      +Vsupply
*                   |      |      -Vsupply
*                   |      |      |      output
*                   |      |      |      |
.subckt ISL28233    3      2      7      4      6
*
*Voltage Noise
D_DN1    102 101 DN
D_DN2    104 103 DN
R_R21    0 101 120k
R_R22    0 103 120k
E_EN     8 3 101 103 1
V_V15    102 0 0.1Vdc
V_V16    104 0 0.1Vdc
*
*Input Stage
C_Cin1    8 0 0.4p
C_Cin2    2 0 2.0p
R_R1     9 10 10
R_R2     10 11 10
R_R3     4 12 100
R_R4     4 13 100
M_M1     12 8 9 9 pmosisil
+ L=50u
+ W=50u
M_M2     13 2 11 11 pmosisil
+ L=50u
+ W=50u
I_I1     4 7 DC 92uA
I_I2     7 10 DC 100uA
*
*Gain stage
G_G1     4 VV2 13 12 0.0002
G_G2     7 VV2 13 12 0.0002
R_R5     4 VV2 1.3Meg
R_R6     VV2 7 1.3Meg
D_D1     4 14 DX
D_D2     15 7 DX
V_V3     VV2 14 0.7Vdc
V_V4     15 VV2 0.7Vdc
*
*SR limit first pole
G_G3     4 VV3 VV2 16 1
G_G4     7 VV3 VV2 16 1
R_R7     4 VV3 1meg
R_R8     VV3 7 1meg
C_C1     VV3 7 12u
C_C2     4 VV3 12u
D_D3     4 17 DX
D_D4     18 7 DX
V_V5     VV3 17 0.7Vdc
V_V6     18 VV3 0.7Vdc
*
*Zero/Pole
E_E1     16 4 7 4 0.5
G_G5     4 VV4 VV3 16 0.000001
G_G6     7 VV4 VV3 16 0.000001
L_L1     20 7 0.3H
R_R12    20 7 2.5meg
R_R11    VV4 20 1meg
L_L2     4 19 0.3H
R_R9     4 19 2.5meg
R_R10    19 VV4 1meg
*Pole
G_G7     4 VV5 VV4 16 0.000001
G_G8     7 VV5 VV4 16 0.000001
C_C3     VV5 7 0.12p
C_C4     4 VV5 0.12p
R_R13    4 VV5 1meg
R_R14    VV5 7 1meg
*
*Output Stage
G_G9     21 4 6 VV5 0.0000125
G_G10    22 4 VV5 6 0.0000125
D_D5     4 21 DY
D_D6     4 22 DY
D_D7     7 21 DX
D_D8     7 22 DX
R_R15    4 6 8k
R_R16    6 7 8k
G_G11    6 4 VV5 4 -0.000125
G_G12    7 6 7 VV5 -0.000125
*
.model pmosisil pmos (kp=16e-3 vto=10m)
.model DN D(KF=6.4E-16 AF=1)
.MODEL DX D(IS=1E-18 Rs=1)
.MODEL DY D(IS=1E-15 BV=50 Rs=1)
.ends ISL28233

```

FIGURE 45. SPICE NET LIST

Characterization vs Simulation Results

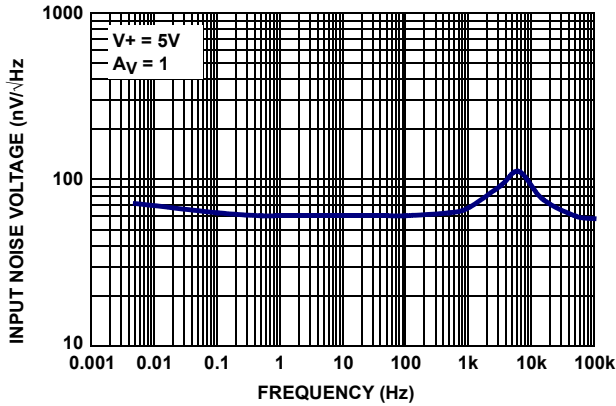

FIGURE 46. CHARACTERIZED INPUT NOISE VOLTAGE DENSITY vs FREQUENCY

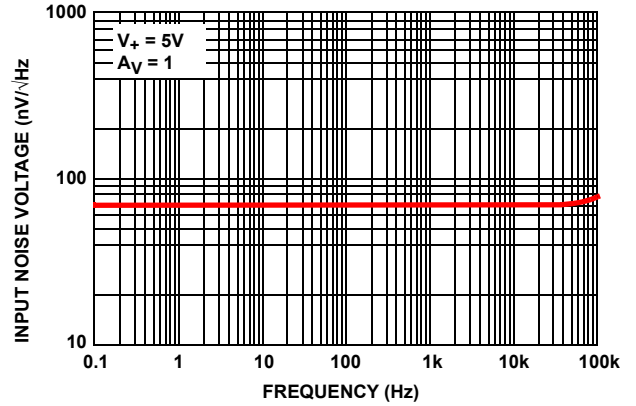

FIGURE 47. SIMULATED INPUT NOISE VOLTAGE DENSITY vs FREQUENCY

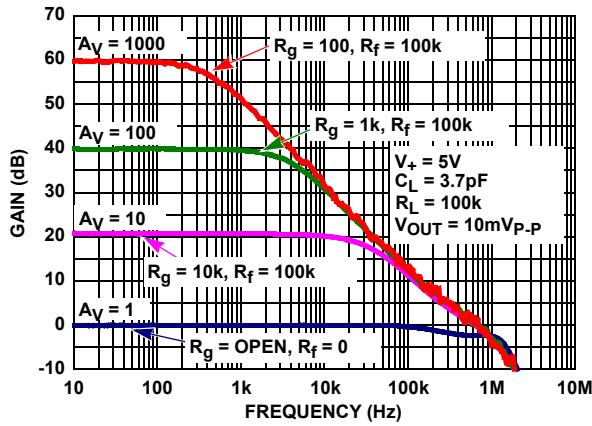

FIGURE 48. CHARACTERIZED FREQUENCY RESPONSE vs CLOSED LOOP GAIN

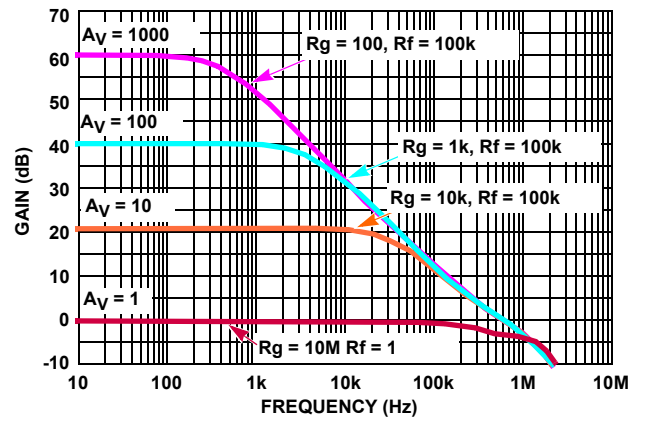

FIGURE 49. SIMULATED FREQUENCY RESPONSE vs CLOSED LOOP GAIN

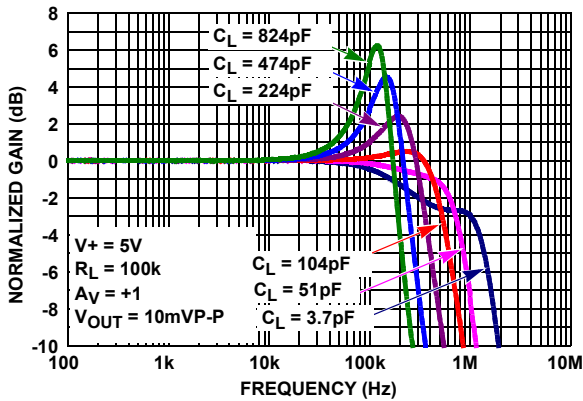

FIGURE 50. CHARACTERIZED GAIN vs FREQUENCY vs C_L

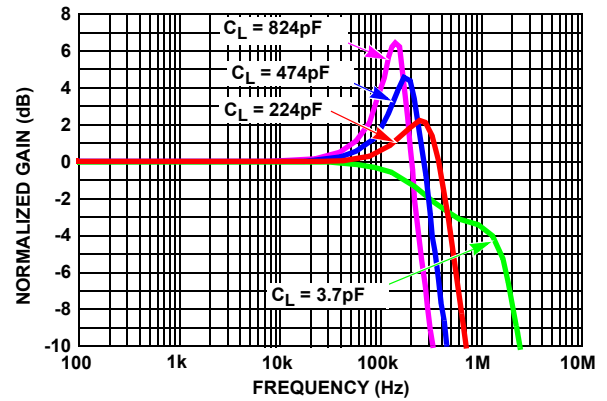

FIGURE 51. SIMULATED GAIN vs FREQUENCY vs C_L

Characterization vs Simulation Results (Continued)

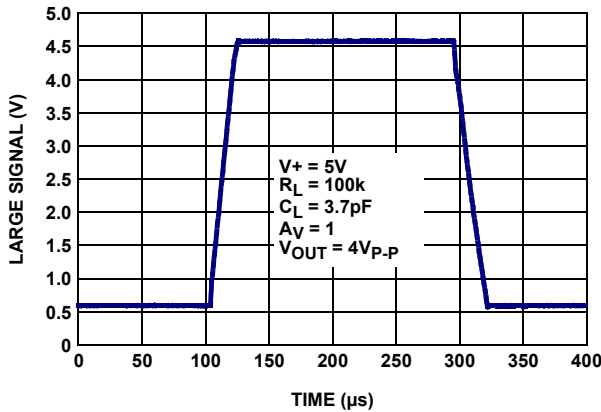

FIGURE 52. CHARACTERIZED LARGE SIGNAL STEP RESPONSE (4V)

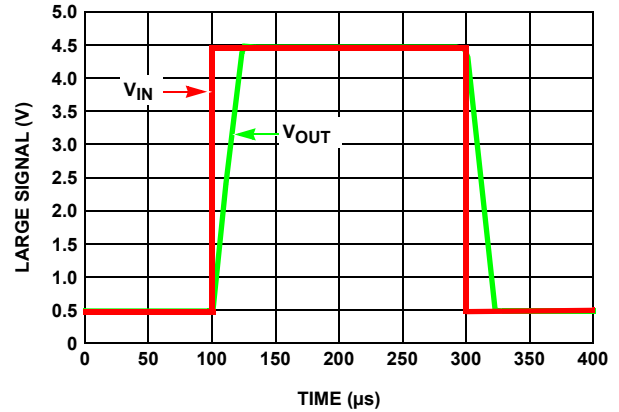

FIGURE 53. SIMULATED LARGE SIGNAL STEP RESPONSE (4V)

Revision History

The revision history provided is for informational purposes only and is believed to be accurate, but not warranted. Please go to web to make sure you have the latest Rev.

DATE	REVISION	CHANGE
Apr 15, 2024	3.01	Removed Related Literature section. Updated Ordering Information table. Removed TDFN information from document. Removed Products section. Updated POD L8.3X3J to the latest revision; changes are as follows: -Tiebar Note 5 updated.
May 31, 2011	3.00	Changed minimum operating supply voltage from +1.65V to +1.8V throughout entire datasheet.
Mar 24, 2011		Added to Ordering Information Table on page 2 - ISL28233SOICEVAL1Z, ISL28433TSSOPEVAL1Z, ISL28433SOICEVAL1Z
Dec 2, 2010	2.00	Added "Related Literature" on page 1 Removed "Coming Soon" from ISL28233FRZ device (8 Ld DFN) in "Ordering Information" on page 2. Corrected Thermal Pad Pin Name in "Pin Descriptions" on page 4 from "NC" to "PAD" Corrected θ_{JA} note for TDFN package in "Thermal Information" on page 5 from " θ_{JA} is measured with the component mounted on a high effective thermal conductivity test board in free air. See Tech Brief TB379 for details." To " θ_{JA} is measured in free air with the component mounted on a high effective thermal conductivity test board with "direct attach" features. See Tech Brief TB379." (since TDFN has thermal pad; TDFN package option not released yet)
Oct 27, 2010	1.00	Changed Part Marking for ISL28233FUZ from 8233Z to 233FZ in "Ordering Information" table on page 2 Added ISL28233 in DFN package to Ordering Information" table on page 2. On page 6, removed Note 8. Changed note in MIN MAX columns of "Electrical Specifications" table from: "Parameters with MIN and/or MAX limits are 100% tested at +25°C, unless otherwise specified. Temperature limits established by characterization and are not production tested." To: "Compliance to datasheet limits is assured by one or more methods: production test, characterization and/or design."
Aug 25, 2010	0.00	Initial Release.

Package Outline Drawings

For the most recent package outline drawing, see [L8.3x3J](#).

L8.3x3J

8 LEAD DUAL FLAT NO-LEAD PLASTIC PACKAGE

Rev 1 3/15

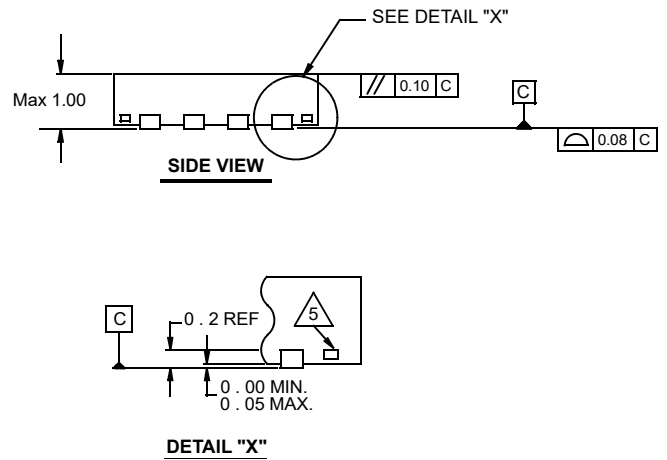
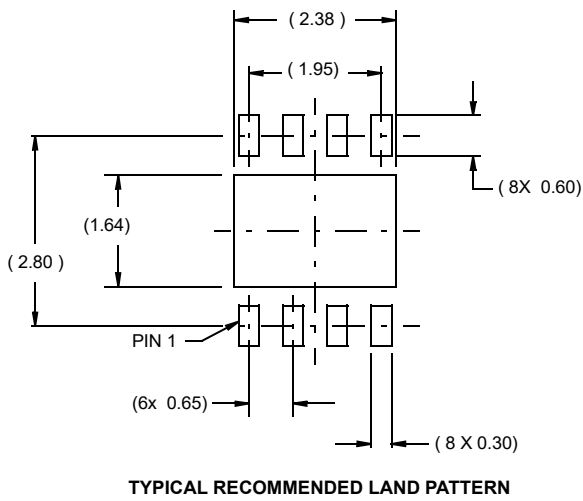
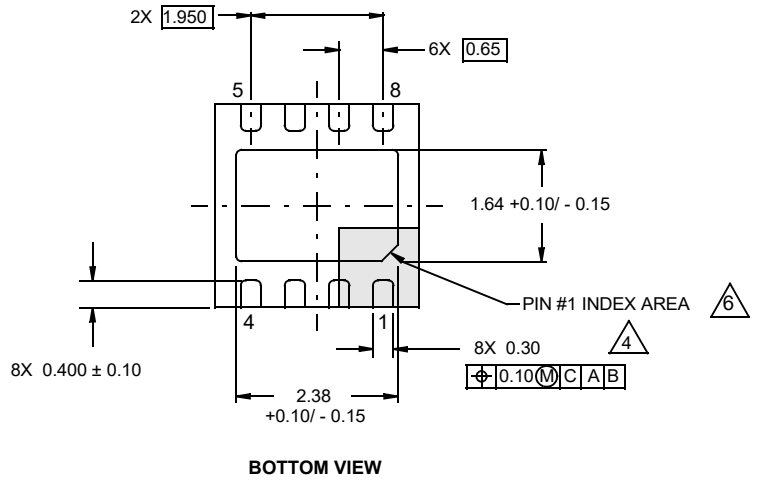
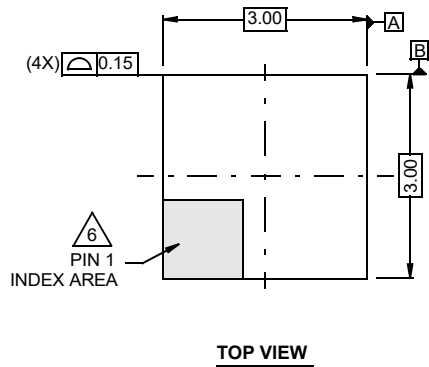

NOTES:

1. Dimensions are in millimeters.
Dimensions in () for Reference Only.
2. Dimensioning and tolerancing conform to AMSE Y14.5m-1994.
3. Unless otherwise specified, tolerance : Decimal ± 0.05
4. Dimension applies to the metallized terminal and is measured between 0.15mm and 0.30mm from the terminal tip.
5. Tiebar shown (if present) is a non-functional feature and may be located on any of the 4 sides (or ends).
6. The configuration of the pin #1 identifier is optional, but must be located within the zone indicated. The pin #1 identifier may be either a mold or mark feature.

For the most recent package outline drawing, see [M8.15E](#).

M8.15E
8 LEAD NARROW BODY SMALL OUTLINE PLASTIC PACKAGE
 Rev 0, 08/09

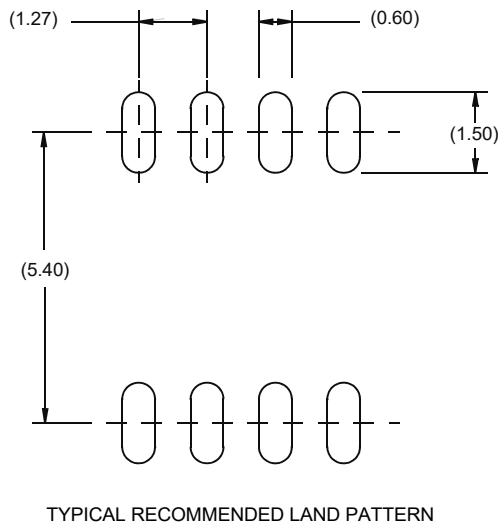
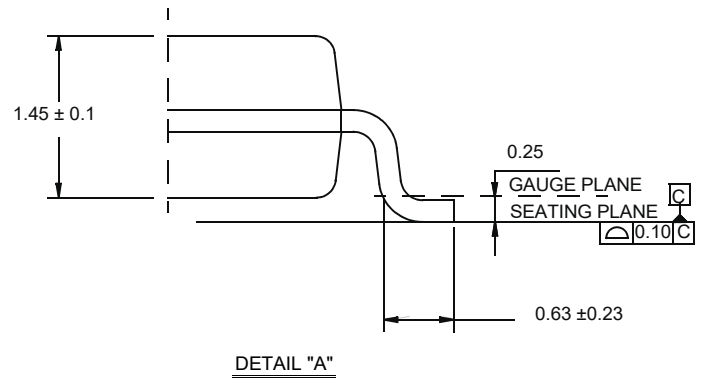
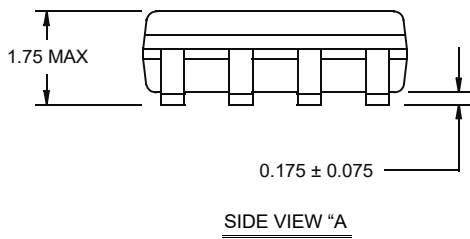
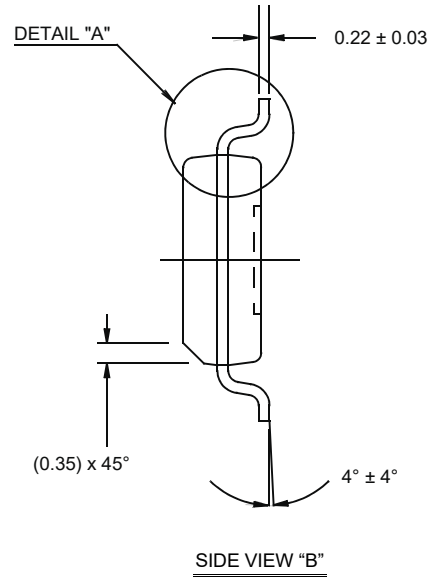
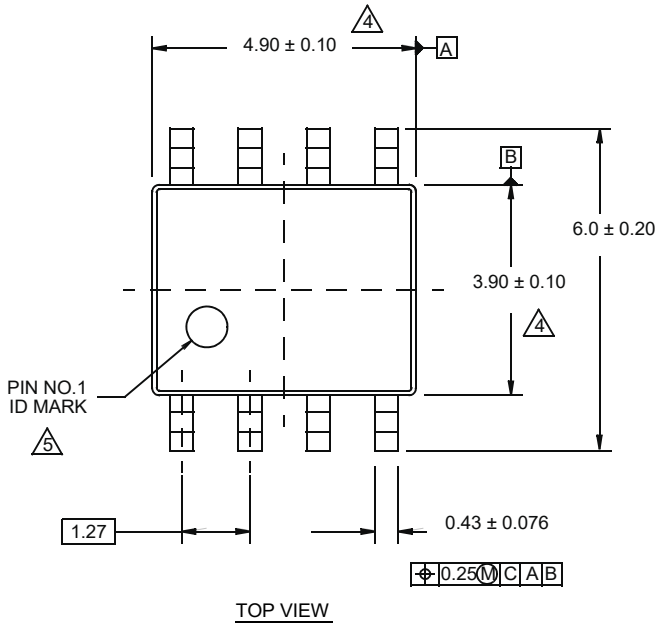

NOTES:

1. Dimensions are in millimeters.
Dimensions in () for Reference Only.
2. Dimensioning and tolerancing conform to AMSE Y14.5m-1994.
3. Unless otherwise specified, tolerance : Decimal ± 0.05
4. Dimension does not include interlead flash or protrusions.
Interlead flash or protrusions shall not exceed 0.25mm per side.
5. The pin #1 identifier may be either a mold or mark feature.
6. Reference to JEDEC MS-012.

For the most recent package outline drawing, see [M8.118A](#).

M8.118A
 8 LEAD MINI SMALL OUTLINE PLASTIC PACKAGE (MSOP)
 Rev 0, 9/09

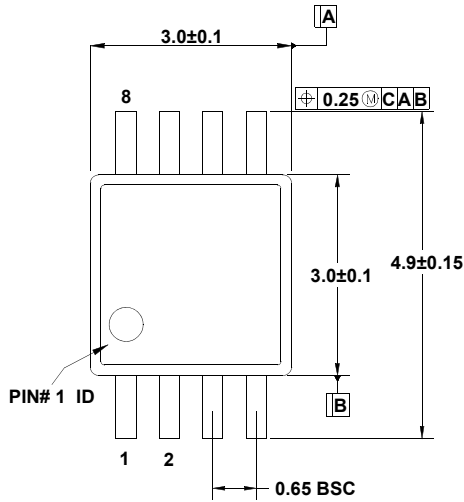

TOP VIEW

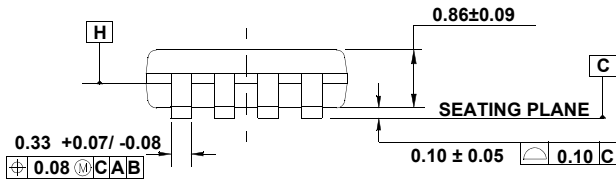
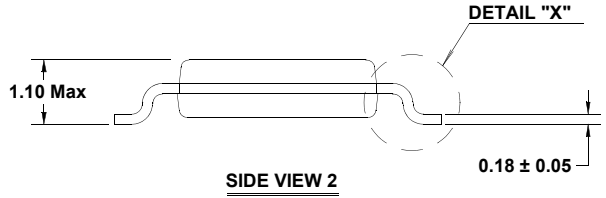

SIDE VIEW 1

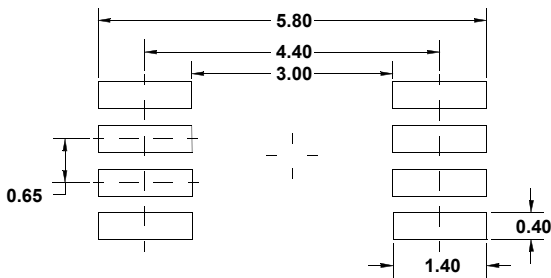
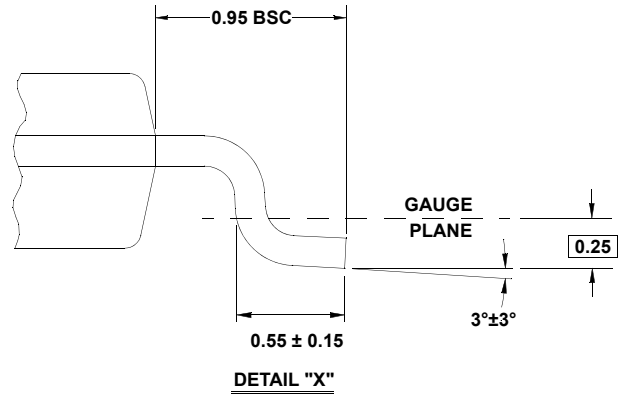

TYPICAL RECOMMENDED LAND PATTERN

NOTES:

1. Dimensions are in millimeters.
2. Dimensioning and tolerancing conform to JEDEC MO-187-AA and AMSE Y14.5m-1994.
3. Plastic or metal protrusions of 0.15mm max per side are not included.
4. Plastic interlead protrusions of 0.25mm max per side are not included.
5. Dimensions "D" and "E1" are measured at Datum Plane "H".
6. This replaces existing drawing # MDP0043 MSOP 8L.

For the most recent package outline drawing, see [MDP0044](#).

MDP0044
THIN SHRINK SMALL OUTLINE PACKAGE FAMILY

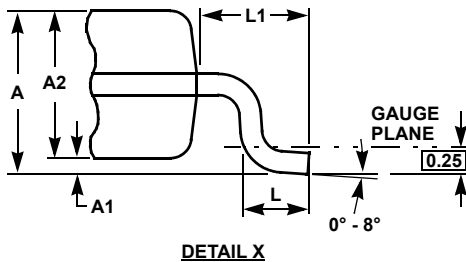
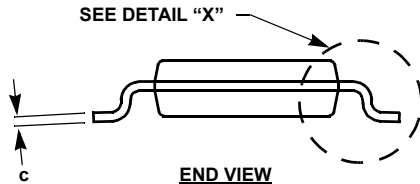
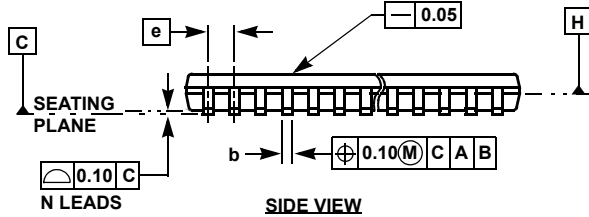
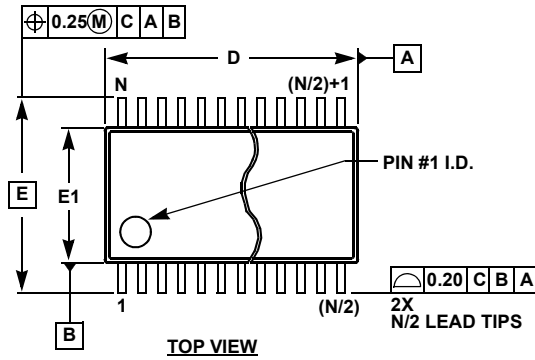

SYMBOL	MILLIMETERS					TOLERANCE
	14 LD	16 LD	20 LD	24 LD	28 LD	
A	1.20	1.20	1.20	1.20	1.20	Max
A1	0.10	0.10	0.10	0.10	0.10	±0.05
A2	0.90	0.90	0.90	0.90	0.90	±0.05
b	0.25	0.25	0.25	0.25	0.25	+0.05/-0.06
c	0.15	0.15	0.15	0.15	0.15	+0.05/-0.06
D	5.00	5.00	6.50	7.80	9.70	±0.10
E	6.40	6.40	6.40	6.40	6.40	Basic
E1	4.40	4.40	4.40	4.40	4.40	±0.10
e	0.65	0.65	0.65	0.65	0.65	Basic
L	0.60	0.60	0.60	0.60	0.60	±0.15
L1	1.00	1.00	1.00	1.00	1.00	Reference

Rev. F 2/07

NOTES:

- Dimension "D" does not include mold flash, protrusions or gate burrs. Mold flash, protrusions or gate burrs shall not exceed 0.15mm per side.
- Dimension "E1" does not include interlead flash or protrusions. Interlead flash and protrusions shall not exceed 0.25mm per side.
- Dimensions "D" and "E1" are measured at dAtum Plane H.
- Dimensioning and tolerancing per ASME Y14.5M-1994.

For the most recent package outline drawing, see [MDP0027](#).

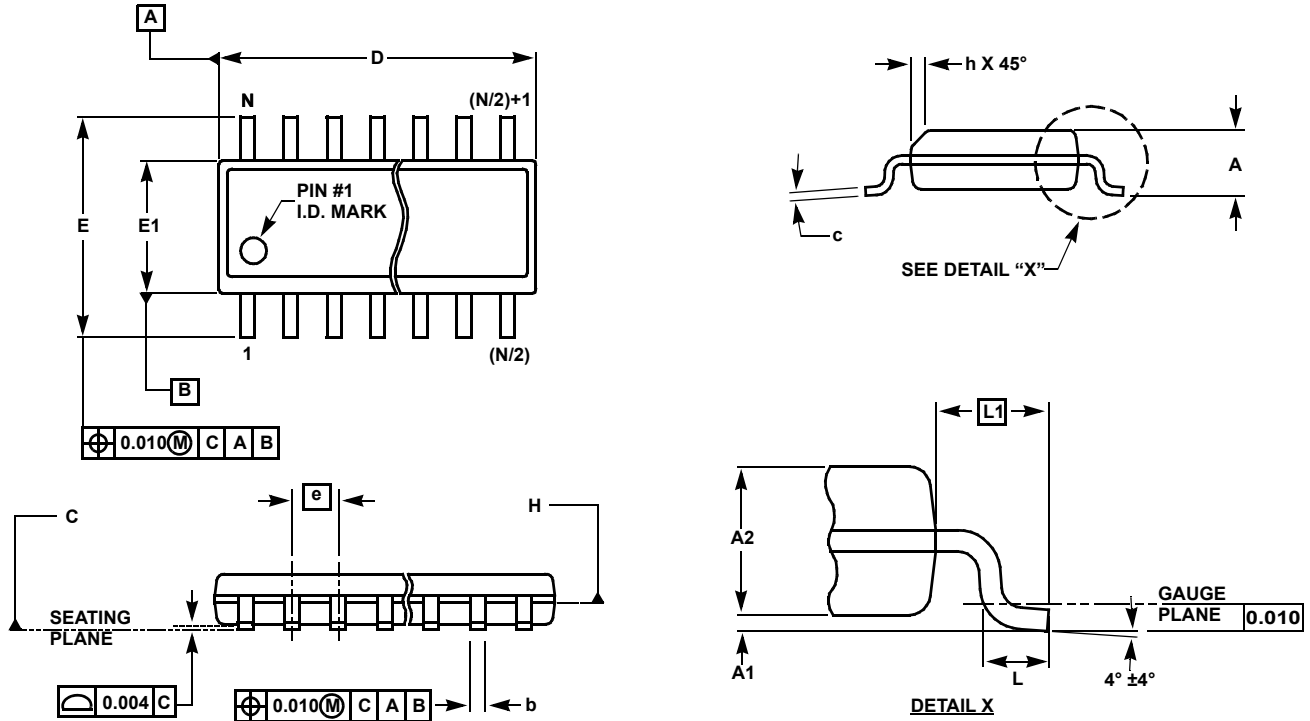

MDP0027
SMALL OUTLINE PACKAGE FAMILY (SO)

SYMBOL	INCHES							TOLERANCE	NOTES
	SO-8	SO-14	SO16 (0.150")	SO16 (0.300") (SOL-16)	SO20 (SOL-20)	SO24 (SOL-24)	SO28 (SOL-28)		
A	0.068	0.068	0.068	0.104	0.104	0.104	0.104	MAX	-
A1	0.006	0.006	0.006	0.007	0.007	0.007	0.007	±0.003	-
A2	0.057	0.057	0.057	0.092	0.092	0.092	0.092	±0.002	-
b	0.017	0.017	0.017	0.017	0.017	0.017	0.017	±0.003	-
c	0.009	0.009	0.009	0.011	0.011	0.011	0.011	±0.001	-
D	0.193	0.341	0.390	0.406	0.504	0.606	0.704	±0.004	1, 3
E	0.236	0.236	0.236	0.406	0.406	0.406	0.406	±0.008	-
E1	0.154	0.154	0.154	0.295	0.295	0.295	0.295	±0.004	2, 3
e	0.050	0.050	0.050	0.050	0.050	0.050	0.050	Basic	-
L	0.025	0.025	0.025	0.030	0.030	0.030	0.030	±0.009	-
L1	0.041	0.041	0.041	0.056	0.056	0.056	0.056	Basic	-
h	0.013	0.013	0.013	0.020	0.020	0.020	0.020	Reference	-
N	8	14	16	16	20	24	28	Reference	-

Rev. M 2/07

NOTES:

1. Plastic or metal protrusions of 0.006" maximum per side are not included.
2. Plastic interlead protrusions of 0.010" maximum per side are not included.
3. Dimensions "D" and "E1" are measured at Datum Plane "H".
4. Dimensioning and tolerancing per ASME Y14.5M-1994

IMPORTANT NOTICE AND DISCLAIMER

RENESAS ELECTRONICS CORPORATION AND ITS SUBSIDIARIES (“RENESAS”) PROVIDES TECHNICAL SPECIFICATIONS AND RELIABILITY DATA (INCLUDING DATASHEETS), DESIGN RESOURCES (INCLUDING REFERENCE DESIGNS), APPLICATION OR OTHER DESIGN ADVICE, WEB TOOLS, SAFETY INFORMATION, AND OTHER RESOURCES “AS IS” AND WITH ALL FAULTS, AND DISCLAIMS ALL WARRANTIES, EXPRESS OR IMPLIED, INCLUDING, WITHOUT LIMITATION, ANY IMPLIED WARRANTIES OF MERCHANTABILITY, FITNESS FOR A PARTICULAR PURPOSE, OR NON-INFRINGEMENT OF THIRD-PARTY INTELLECTUAL PROPERTY RIGHTS.

These resources are intended for developers who are designing with Renesas products. You are solely responsible for (1) selecting the appropriate products for your application, (2) designing, validating, and testing your application, and (3) ensuring your application meets applicable standards, and any other safety, security, or other requirements. These resources are subject to change without notice. Renesas grants you permission to use these resources only to develop an application that uses Renesas products. Other reproduction or use of these resources is strictly prohibited. No license is granted to any other Renesas intellectual property or to any third-party intellectual property. Renesas disclaims responsibility for, and you will fully indemnify Renesas and its representatives against, any claims, damages, costs, losses, or liabilities arising from your use of these resources. Renesas' products are provided only subject to Renesas' Terms and Conditions of Sale or other applicable terms agreed to in writing. No use of any Renesas resources expands or otherwise alters any applicable warranties or warranty disclaimers for these products.

(Disclaimer Rev.1.01 Jan 2024)

Corporate Headquarters

TOYOSU FORESIA, 3-2-24 Toyosu,
Koto-ku, Tokyo 135-0061, Japan
www.renesas.com

Trademarks

Renesas and the Renesas logo are trademarks of Renesas Electronics Corporation. All trademarks and registered trademarks are the property of their respective owners.

Contact Information

For further information on a product, technology, the most up-to-date version of a document, or your nearest sales office, please visit www.renesas.com/contact-us/.

Mouser Electronics

Authorized Distributor

Click to View Pricing, Inventory, Delivery & Lifecycle Information:

[Renesas Electronics:](#)

[ISL28233FBZ](#) [ISL28233FBZ-T7](#) [ISL28233FBZ-T7A](#) [ISL28233FRZ](#) [ISL28233FRZ-T13](#) [ISL28233FRZ-T7](#)
[ISL28233FRZ-T7A](#) [ISL28233FUZ](#) [ISL28233FUZ-T7](#) [ISL28233FUZ-T7A](#) [ISL28433FBZ](#) [ISL28433FBZ-T7](#)
[ISL28433FBZ-T7A](#) [ISL28433FVZ-T13](#) [ISL28433FVZ-T7A](#) [ISL28433FVZ](#)