



# Bridgelux® Gen 7 Vero® 10 Array Series

Product Data Sheet DS90



# Introduction

Vero® Series



Vero® Series is a revolutionary advancement in chip on board (COB) light source technology and innovation. Vero LED light sources simplify luminaire design and manufacturing processes. Vero Chip on Board (COB) LED arrays are available in four LES configurations, engineered to enable new degrees of flexibility and reliability over a broad range of electrical currents. Vero arrays deliver increased lumen density to enable improved beam control and precision lighting with 2 and 3 SDCM color control standard for clean and consistent uniform lighting.

Vero products include an onboard connector port that enables a solder-free electrical interconnect, and simple mounting features for plug-and-play installation.

Bridgelux Décor Series™ is our state-of-the-art color line designed specifically for premium applications, producing unmatched LED light quality with brilliant color-rendering options and pleasing lighting palettes. Bridgelux Décor Series color points are available on Vero® SE Series, Vero® Series, V Series™ and H Series™.

**Décor Series Class A** is based on human response testing, providing color points with a combined GAI and CRI metric.

**Décor Series™ Ultra** products provide a high CRI of 97 and minimum R<sub>9</sub> value of 93, which emphasizes the reds and color tones to which the human eye is most receptive - perfect for the most luxurious retail shops and world renowned museums. Décor Series Ultra is designed as a replacement for halogen lamps.

**Décor Series™ Street and Landmark** is designed to be a direct replacement for high pressure sodium lamps.

**Décor Series™ Showcase** is the optimal solution for replacing ceramic metal halide lamps, incorporating the same pure white light with enhanced spectrum coverage and higher efficacy.

## Features

- Efficacy of 150 lm/W typical
- Lumen output performance ranges from 583 to 3,970 lumens
- Broad range of CCT options from 2700K to 6500K
- CRI options include minimum 65, 70, 80, and 90
- 2 and 3 SDCM color control for 2700K-4000K CCT
- Reliable operation at up to 2X nominal drive current
- Radial die pattern and improved lumen density
- Thermally isolated solder pads
- On-board connector port
- Top side part number markings
- V<sub>r</sub> bin code backside marking

## Benefits

- Broad application coverage for interior and exterior lighting
- Flexibility for application driven lighting design requirements
- High quality true color reproduction
- Uniform consistent white light
- Flexibility in design optimization
- Enhanced ease of use and assembly
- Solderless connectivity enables plug & play installation and field upgradability
- Improved inventory management and quality control



# Contents

Product Feature Map	2
Product Nomenclature	2
Product Selection Guide	3
Performance at Commonly Used Drive Currents	8
Electrical Characteristics	15
Eye Safety	16
Absolute Maximum Ratings	17
Performance Curves	18
Typical Radiation Pattern	21
Typical Color Spectrum	22
Mechanical Dimensions	23
Color Binning Information	24
Packaging and Labeling	25
Design Resources	27
Precautions	27
Disclaimers	27
About Bridgelux	28

# Product Feature Map

Vero 10 is the smallest form factor in the Vero family of next generation solid state light sources. In addition to delivering the performance and light quality required for many lighting applications, Vero incorporates several

features to simplify the design integration and manufacturing process, accelerate time to market and reduce system costs. Please visit [www.bridgelux.com](http://www.bridgelux.com) for more information on the Vero Series family of products.

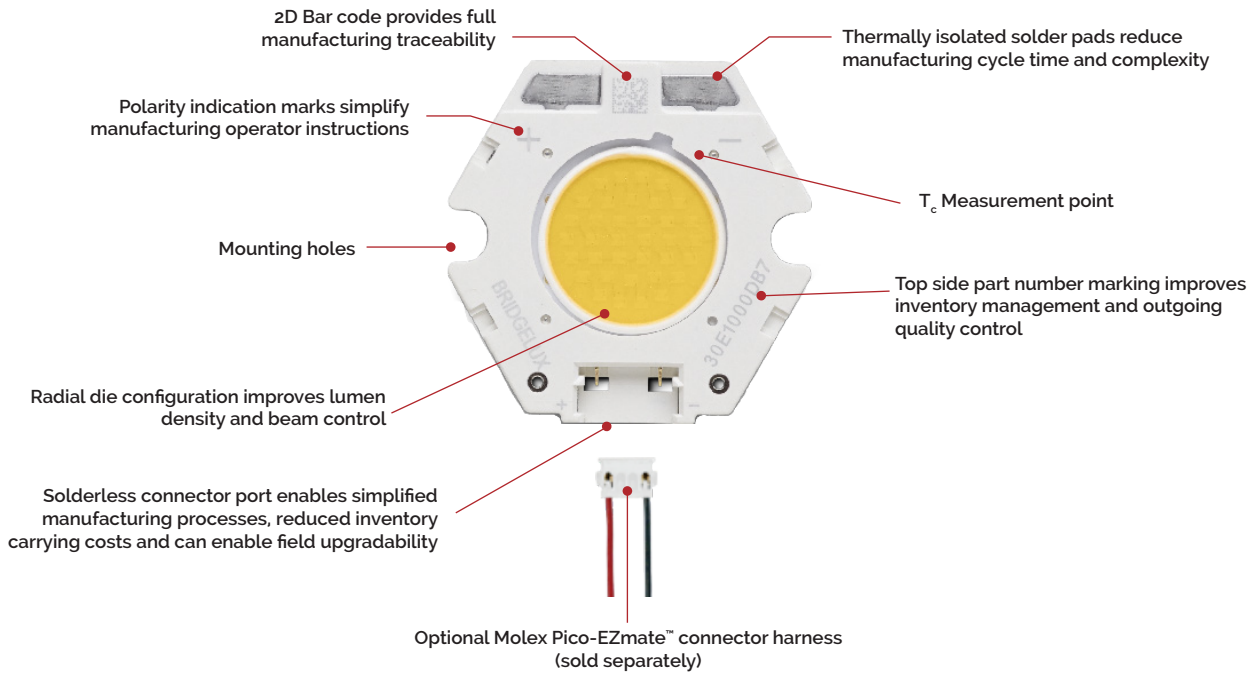

## Product Nomenclature

The part number designation for Bridgelux Vero LED arrays is explained as follows:

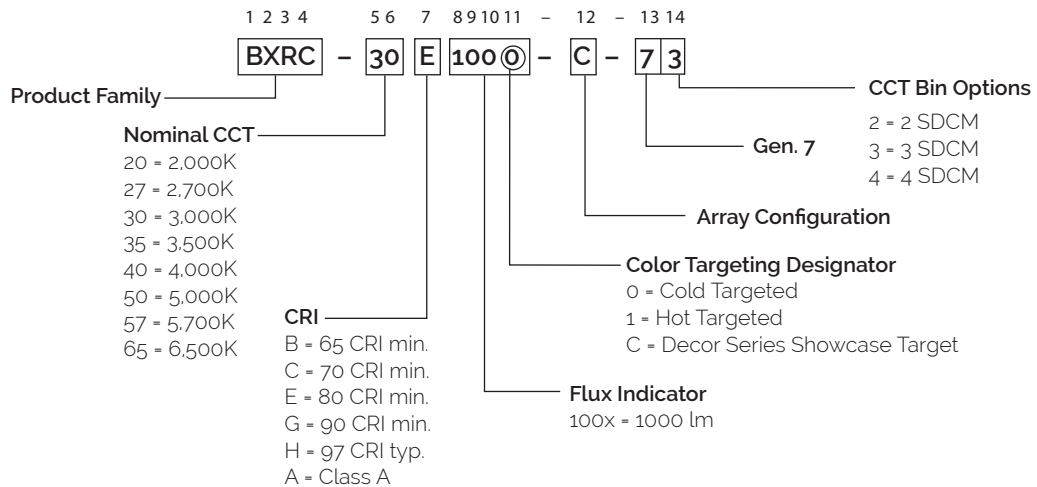

# Product Selection Guide

The following product configurations are available:

**Table 1:** Selection Guide, Pulsed Measurement Data ( $T_j = T_c = 25^\circ\text{C}$ )

Part Number	Nominal CCT <sup>1</sup> (K)	CRI <sup>2</sup>	Nominal Drive Current <sup>3</sup> (mA)	Typical Pulsed Flux <sup>4,5,6</sup> $T_c = 25^\circ\text{C}$ (lm)	Minimum Pulsed Flux <sup>6,7</sup> $T_c = 25^\circ\text{C}$ (lm)	Typical $V_f$ (V)	Typical Power (W)	Typical Efficacy (lm/W)
BXRC-20B1001-B-73	2000	65	270	1328	1169	34.8	9.4	141
BXRC-20B1001-D-73	2000	65	350	1284	1130	26.0	9.1	141
BXRC-27E1000-B-7X	2700	80	270	1348	1187	34.8	9.4	144
BXRC-27E1000-C-7X	2700	80	360	1797	1581	34.8	12.5	143
BXRC-27E1000-D-7X	2700	80	350	1310	1153	26.0	9.1	144
BXRC-27G1000-B-7X	2700	90	270	1124	989	34.8	9.4	120
BXRC-27G1000-C-7X	2700	90	360	1498	1318	34.8	12.5	120
BXRC-27G1000-D-7X	2700	90	350	1092	961	26.0	9.1	120
BXRC-27H1000-B-7x	2700	97	270	984	866	34.8	9.4	105
BXRC-27H1000-C-7x	2700	97	360	1311	1154	34.8	12.5	105
BXRC-27H1000-D-7x	2700	97	350	956	841	26.0	9.1	105
BXRC-30E1000-B-7X	3000	80	270	1418	1247	34.8	9.4	151
BXRC-30E1000-C-7X	3000	80	360	1890	1663	34.8	12.5	151
BXRC-30E1000-D-7X	3000	80	350	1365	1201	26.0	9.1	150
BXRC-30G1000-B-7X	3000	90	270	1166	1026	34.8	9.4	124
BXRC-30G1000-C-7X	3000	90	360	1554	1367	34.8	12.5	124
BXRC-30G1000-D-7X	3000	90	350	1133	997	26.0	9.1	125
BXRC-30G100C-B-73	3000	90	270	1092	961	35.0	9.5	116
BXRC-30G100C-D-73	3000	90	350	1056	929	26.0	9.1	116
BXRC-30H1000-B-7x	3000	97	270	1054	927	34.8	9.4	112
BXRC-30H1000-C-7x	3000	97	360	1404	1236	34.8	12.5	112
BXRC-30H1000-D-7x	3000	97	350	1024	901	26.0	9.1	113
BXRC-30A1001-B-73 <sup>8,9</sup>	3000	93	270	1086	956	34.8	9.4	116
BXRC-30A1001-C-73 <sup>8,9</sup>	3000	93	360	1448	1274	34.8	12.5	116
BXRC-30A1001-D-73 <sup>8,9</sup>	3000	93	350	1056	929	26.0	9.1	116
BXRC-35E1000-B-7X	3500	80	270	1447	1273	34.8	9.4	154
BXRC-35E1000-C-7X	3500	80	360	1928	1697	34.8	12.5	154
BXRC-35E1000-D-7X	3500	80	350	1406	1237	26.0	9.1	155
BXRC-35G1000-B-7X	3500	90	270	1208	1063	34.8	9.4	129
BXRC-35G1000-C-7X	3500	90	360	1610	1417	34.8	12.5	129
BXRC-35G1000-D-7X	3500	90	350	1174	1033	26.0	9.1	129

Notes for Table 1:

- Nominal CCT as defined by ANSI C78.377-2011. Products with a CCT of 5000K-6500K are hot targeted to  $T_c = 85^\circ\text{C}$ .
- CRI values are typical for Decor Series Ultra and Decor Series Class A products. CRI values are minimums for all other products. Minimum Rg value for 80 CRI products is 0, the minimum Rg values for 90 CRI products is 50, the minimum Rg values for 97 CRI products is 93. Bridgelux maintains a  $\pm 3$  tolerance on Rg values.
- Drive current is referred to as nominal drive current.
- Products tested under pulsed condition (10ms pulse width) at nominal test current where  $T_j$  (junction temperature) -  $T_c$  (case temperature) =  $25^\circ\text{C}$ .
- Typical performance values are provided as a reference only and are not a guarantee of performance.
- Bridgelux maintains a  $\pm 7\%$  tolerance on flux measurements.
- Minimum flux values at the nominal test current are guaranteed by 100% test.
- Nominal CCT is defined by the Lighting Research Center's Class A definition. The center of the Class A color bin is on the corresponding isothermal line.
- GAI value is 80. To help ensure optimal fixture level performance, GAI is measured at the fixture level, on axis, at a case temperature of  $70^\circ\text{C}$ . GAI may vary depending on fixture design and performance.

# Product Selection Guide

**Table 1:** Selection Guide, Pulsed Measurement Data ( $T_j = T_c = 25^\circ\text{C}$ ) (continued)

Part Number	Nominal CCT <sup>1</sup> (K)	CRI <sup>2</sup>	Nominal Drive Current <sup>3</sup> (mA)	Typical Pulsed Flux <sup>4,5,6</sup> $T_c = 25^\circ\text{C}$ (lm)	Minimum Pulsed Flux <sup>6,7</sup> $T_c = 25^\circ\text{C}$ (lm)	Typical $V_f$ (V)	Typical Power (W)	Typical Efficacy (lm/W)
BXRC-35A1001-B-73 <sup>8,9</sup>	3500	93	270	1170	1030	34.8	9.4	125
BXRC-35A1001-C-73 <sup>8,9</sup>	3500	93	360	1560	1373	34.8	12.5	125
BXRC-35A1001-D-73 <sup>8,9</sup>	3500	93	350	1138	1001	26.0	9.1	125
BXRC-40E1000-B-7X	4000	80	270	1461	1285	34.8	9.4	155
BXRC-40E1000-C-7X	4000	80	360	1947	1713	34.8	12.5	155
BXRC-40E1000-D-7X	4000	80	350	1420	1249	26.0	9.1	156
BXRC-40G1000-B-7X	4000	90	270	1250	1100	34.8	9.4	133
BXRC-40G1000-C-7X	4000	90	360	1666	1466	34.8	12.5	133
BXRC-40G1000-D-7X	4000	90	350	1215	1069	26.0	9.1	134
BXRC-40A1001-B-73 <sup>8,9</sup>	4000	93	270	1245	1096	34.8	9.4	133
BXRC-40A1001-C-73 <sup>8,9</sup>	4000	93	360	1660	1461	34.8	12.5	133
BXRC-40A1001-D-73 <sup>8,9</sup>	4000	93	350	1210	1065	26.0	9.1	133
BXRC-50C1001-B-7X	5000	70	270	1601	1409	34.8	9.4	170
BXRC-50C1001-C-7X	5000	70	360	2134	1878	34.8	12.5	170
BXRC-50C1001-D-7X	5000	70	350	1556	1369	26.0	9.1	171
BXRC-50E1001-B-7X	5000	80	270	1505	1324	34.8	9.4	160
BXRC-50E1001-C-7X	5000	80	360	2006	1765	34.8	12.5	160
BXRC-50E1001-D-7X	5000	80	350	1463	1287	26.0	9.1	161
BXRC-50G1001-B-7X	5000	90	270	1281	1127	34.8	9.4	136
BXRC-50G1001-C-7X	5000	90	360	1707	1502	34.8	12.5	136
BXRC-50G1001-D-7X	5000	90	350	1245	1095	26.0	9.1	137
BXRC-57C1001-B-7X	5700	70	270	1545	1360	34.8	9.4	164
BXRC-57C1001-C-7X	5700	70	360	2059	1812	34.8	12.5	164
BXRC-57C1001-D-7X	5700	70	350	1502	1321	26.0	9.1	165
BXRC-57E1001-B-7X	5700	80	270	1531	1347	34.8	9.4	163
BXRC-57E1001-C-7X	5700	80	360	2040	1796	34.8	12.5	163
BXRC-57E1001-D-7X	5700	80	350	1488	1309	26.0	9.1	164
BXRC-65C1001-B-7X	6500	70	270	1573	1384	34.8	9.4	167
BXRC-65C1001-C-7X	6500	70	360	2097	1845	34.8	12.5	167
BXRC-65C1001-D-7X	6500	70	350	1529	1345	26.0	9.1	168
BXRC-65E1001-B-7X	6500	80	270	1559	1372	34.8	9.4	166
BXRC-65E1001-C-7X	6500	80	360	2078	1829	34.8	12.5	166
BXRC-65E1001-D-7X	6500	80	350	1515	1333	26.0	9.1	167

Notes for Table 1:

- Nominal CCT as defined by ANSI C78.377-2011. Products with a CCT of 5000K-6500K are hot targeted to  $T_c = 85^\circ\text{C}$ .
- CRI values are typical for Decor Series Ultra and Decor Series Class A products. CRI values are minimums for all other products. Minimum R<sub>g</sub> value for 80 CRI products is 0, the minimum R<sub>g</sub> values for 90 CRI products is 50, the minimum R<sub>g</sub> values for 97 CRI products is 93. Bridgelux maintains a  $\pm 3$  tolerance on R<sub>g</sub> values.
- Drive current is referred to as nominal drive current.
- Products tested under pulsed condition (10ms pulse width) at nominal test current where  $T_j$  (junction temperature) -  $T_c$  (case temperature) =  $25^\circ\text{C}$ .
- Typical performance values are provided as a reference only and are not a guarantee of performance.
- Bridgelux maintains a  $\pm 7\%$  tolerance on flux measurements.
- Minimum flux values at the nominal test current are guaranteed by 100% test.
- Nominal CCT is defined by the Lighting Research Center's Class A definition. The center of the Class A color bin is on the corresponding isothermal line.
- GAI value is 80. To help ensure optimal fixture level performance, GAI is measured at the fixture level, on axis, at a case temperature of  $70^\circ\text{C}$ . GAI may vary depending on fixture design and performance.

# Product Selection Guide

**Table 2:** Selection Guide. Stabilized DC Performance ( $T_c = 70^\circ\text{C}$ ) <sup>7,8</sup>

Part Number	Nominal CCT <sup>1</sup> (K)	GAI <sup>2</sup>	CRI <sup>3</sup>	Nominal Drive Current <sup>4</sup> (mA)	Typical DC Flux <sup>5,6</sup> $T_c = 70^\circ\text{C}$ (lm)	Minimum DC Flux <sup>6,9</sup> $T_c = 70^\circ\text{C}$ (lm)	Typical $V_f$ (V)	Typical Power (W)	Typical Efficacy (lm/W)
BXRC-30A1001-B-73	3000	80	93	270	1010	889	34.3	9.3	109
BXRC-30A1001-C-73	3000	80	93	360	1347	1185	34.3	12.3	109
BXRC-30A1001-D-73	3000	80	93	350	982	864	25.5	8.9	110
BXRC-35A1001-B-73	3500	80	93	270	1088	958	34.3	9.3	118
BXRC-35A1001-C-73	3500	80	93	360	1451	1277	34.3	12.3	118
BXRC-35A1001-D-73	3500	80	93	350	1058	931	25.5	8.9	119
BXRC-40A1001-B-73	4000	80	93	270	1158	1019	34.3	9.3	125
BXRC-40A1001-C-73	4000	80	93	360	1544	1359	34.3	12.3	125
BXRC-40A1001-D-73	4000	80	93	350	1125	990	25.5	8.9	126

Notes for Table 2:

1. Nominal CCT is defined by the Lighting Research Center's Class A definition. The center of the Class A color bin is on the corresponding isothermal line.
2. To help ensure optimal fixture level performance, GAI is measured at the fixture level, on axis, at a case temperature of  $70^\circ\text{C}$ . GAI may vary depending on fixture design and performance.
3. CRI Values are specified as typical.
4. Drive current is referred to as nominal drive current.
5. Typical performance values are provided as a reference only and are not a guarantee of performance.
6. Bridgelux maintains a  $\pm 7\%$  tolerance on flux measurements.
7. Typical stabilized DC performance values are provided as reference only and are not a guarantee of performance.
8. Typical performance is estimated based on operation under DC (direct current) with LED array mounted onto a heat sink with thermal interface material and the case temperature maintained at specified temperature. Based on Bridgelux test setup, values may vary depending on the thermal design of the luminaire and/or the exposed environment to which the product is subjected.
9. Minimum flux values at elevated temperatures are provided for reference only and are not guaranteed by 100% production testing. Based on Bridgelux test setup, values may vary depending on the thermal design of the luminaire and/or the exposed environment to which the product is subjected.

# Product Selection Guide

**Table 3:** Selection Guide, Stabilized DC Performance ( $T_c = 85^\circ\text{C}$ )<sup>4,5</sup>

Part Number	Nominal CCT <sup>1</sup> (K)	CRI <sup>2</sup>	Nominal Drive Current <sup>3</sup> (mA)	Typical DC Flux <sup>4,5</sup> $T_c = 85^\circ\text{C}$ (lm)	Minimum DC Flux <sup>6</sup> $T_c = 85^\circ\text{C}$ (lm)	Typical $V_f$ (V)	Typical Power (W)	Typical Efficacy (lm/W)
BXRC-20B1001-B-73	2000	65	270	1195	1052	33.8	9.1	131
BXRC-20B1001-D-73	2000	65	350	1156	1017	25.3	8.9	131
BXRC-27E1000-B-7X	2700	80	270	1214	1068	33.8	9.1	133
BXRC-27E1000-C-7X	2700	80	360	1617	1423	33.8	12.2	133
BXRC-27E1000-D-7X	2700	80	350	1179	1038	25.3	8.9	133
BXRC-27G1000-B-7X	2700	90	270	1011	890	33.8	9.1	111
BXRC-27G1000-C-7X	2700	90	360	1348	1186	33.8	12.2	111
BXRC-27G1000-D-7X	2700	90	350	983	865	25.3	8.9	111
BXRC-27H1000-B-7x	2700	97	270	886	779	34.8	9.4	94
BXRC-27H1000-C-7x	2700	97	360	1180	1039	34.8	12.5	94
BXRC-27H1000-D-7x	2700	97	350	860	757	26.0	9.1	95
BXRC-30E1000-B-7X	3000	80	270	1276	1123	33.8	9.1	140
BXRC-30E1000-C-7X	3000	80	360	1701	1497	33.8	12.2	140
BXRC-30E1000-D-7X	3000	80	350	1229	1081	25.3	8.9	139
BXRC-30G1000-B-7X	3000	90	270	1049	923	33.8	9.1	115
BXRC-30G1000-C-7X	3000	90	360	1398	1231	33.8	12.2	115
BXRC-30G1000-D-7X	3000	90	350	1020	897	25.3	8.9	115
BXRC-30G100C-B-73	3000	90	270	983	846	34.0	9.2	107
BXRC-30G100C-D-73	3000	90	350	950	818	25.3	8.9	107
BXRC-30H1000-B-7x	3000	97	270	948	835	34.8	9.4	101
BXRC-30H1000-C-7x	3000	97	360	1264	1112	34.8	12.5	101
BXRC-30H1000-D-7x	3000	97	350	922	811	26.0	9.1	101
BXRC-30A1001-B-73 <sup>7,8</sup>	3000	93	270	977	860	34.8	9.4	104
BXRC-30A1001-C-73 <sup>7,8</sup>	3000	93	360	1303	1147	34.8	12.5	104
BXRC-30A1001-D-73 <sup>7,8</sup>	3000	93	350	950	836	26.0	9.1	104
BXRC-35E1000-B-7X	3500	80	270	1302	1146	33.8	9.1	143
BXRC-35E1000-C-7X	3500	80	360	1735	1527	33.8	12.2	142
BXRC-35E1000-D-7X	3500	80	350	1265	1114	25.3	8.9	143
BXRC-35G1000-B-7X	3500	90	270	1087	957	33.8	9.1	119
BXRC-35G1000-C-7X	3500	90	360	1449	1275	33.8	12.2	119
BXRC-35G1000-D-7X	3500	90	350	1057	930	25.0	8.8	121
BXRC-35A1001-B-73 <sup>7,8</sup>	3500	93	270	1053	927	33.8	9.1	115
BXRC-35A1001-C-73 <sup>7,8</sup>	3500	93	360	1404	1236	33.8	12.2	115
BXRC-35A1001-D-73 <sup>7,8</sup>	3500	93	350	1024	901	25.0	8.8	117

Notes for Table 3:

- Nominal CCT as defined by ANSI C78.377-2011. Products with a CCT of 5000K-6500K are hot targeted to  $T_c = 85^\circ\text{C}$ .
- All CRI values are measured at  $T_1 = T_c = 25^\circ\text{C}$ . CRI values are typical for Decor Series Ultra and Decor Series Class A products. CRI values are minimums for all other products. Minimum Rg value for 80 CRI products is 0, the minimum Rg values for 90 CRI products is 50, the minimum Rg values for 97 CRI products is 93. Bridgelux maintains a  $\pm 3$  tolerance on Rg values.
- Drive current is referred to as nominal drive current.
- Typical stabilized DC performance values are provided as reference only and are not a guarantee of performance.
- Typical performance is estimated based on operation under DC (direct current) with LED array mounted onto a heat sink with thermal interface material and the case temperature maintained at  $85^\circ\text{C}$ . Based on Bridgelux test setup, values may vary depending on the thermal design of the luminaire and/or the exposed environment to which the product is subjected.
- Minimum flux values at elevated temperatures are provided for reference only and are not guaranteed by 100% production testing. Based on Bridgelux test setup, values may vary depending on the thermal design of the luminaire and/or the exposed environment to which the product is subjected.
- Nominal CCT is defined by the Lighting Research Center's Class A definition. The center of the Class A color bin is on the corresponding isothermal line.
- GAI value is 80. To help ensure optimal fixture level performance, GAI is measured at the fixture level, on axis, at a case temperature of  $70^\circ\text{C}$ . GAI may vary depending on fixture design and performance.



# Product Selection Guide

**Table 3:** Selection Guide, Stabilized DC Performance ( $T_c = 85^\circ\text{C}$ )<sup>4,5</sup> (continued)

Part Number	Nominal CCT <sup>1</sup> (K)	CRI <sup>2</sup>	Nominal Drive Current <sup>3</sup> (mA)	Typical DC Flux <sup>4,5</sup> $T_c = 85^\circ\text{C}$ (lm)	Minimum DC Flux <sup>6</sup> $T_c = 85^\circ\text{C}$ (lm)	Typical $V_f$ (V)	Typical Power (W)	Typical Efficacy (lm/W)
BXRC-40E1000-B-7X	4000	80	270	1315	1157	33.8	9.1	144
BXRC-40E1000-C-7X	4000	80	360	1752	1542	33.8	12.2	144
BXRC-40E1000-D-7X	4000	80	350	1278	1124	25.0	8.8	146
BXRC-40G1000-B-7X	4000	90	270	1125	990	33.8	9.1	123
BXRC-40G1000-C-7X	4000	90	360	1499	1320	33.8	12.2	123
BXRC-40G1000-D-7X	4000	90	350	1093	962	25.0	8.8	125
BXRC-40A1001-B-73 <sup>7,8</sup>	4000	93	270	1121	986	33.8	9.1	123
BXRC-40A1001-C-73 <sup>7,8</sup>	4000	93	360	1494	1315	33.8	12.2	123
BXRC-40A1001-D-73 <sup>7,8</sup>	4000	93	350	1089	958	25.0	8.8	124
BXRC-50C1001-B-7X	5000	70	270	1441	1268	33.8	9.1	158
BXRC-50C1001-C-7X	5000	70	360	1921	1690	33.8	12.2	158
BXRC-50C1001-D-7X	5000	70	350	1400	1232	25.0	8.8	160
BXRC-50E1001-B-7X	5000	80	270	1355	1192	33.8	9.1	148
BXRC-50E1001-C-7X	5000	80	360	1805	1589	33.8	12.2	148
BXRC-50E1001-D-7X	5000	80	350	1316	1158	25.0	8.8	150
BXRC-50G1001-B-7X	5000	90	270	1153	1015	33.8	9.1	126
BXRC-50G1001-C-7X	5000	90	360	1537	1352	33.8	12.2	126
BXRC-50G1001-D-7X	5000	90	350	1120	986	25.0	8.8	128
BXRC-57C1001-B-7X	5700	70	270	1390	1224	33.8	9.1	152
BXRC-57C1001-C-7X	5700	70	360	1853	1631	33.8	12.2	152
BXRC-57C1001-D-7X	5700	70	350	1351	1189	25.0	8.8	154
BXRC-57E1001-B-7X	5700	80	270	1378	1213	33.8	9.1	151
BXRC-57E1001-C-7X	5700	80	360	1836	1616	33.8	12.2	151
BXRC-57E1001-D-7X	5700	80	350	1339	1178	25.0	8.8	153
BXRC-65C1001-B-7X	6500	70	270	1416	1246	33.8	9.1	155
BXRC-65C1001-C-7X	6500	70	360	1887	1661	33.8	12.2	155
BXRC-65C1001-D-7X	6500	70	350	1376	1211	25.0	8.8	157
BXRC-65E1001-B-7X	6500	80	270	1403	1235	33.8	9.1	154
BXRC-65E1001-C-7X	6500	80	360	1870	1646	33.8	12.2	154
BXRC-65E1001-D-7X	6500	80	350	1364	1200	25.0	8.8	156
BXRC-65E1001-C-7X	6500	80	360	1870	1646	34.0	12.3	153
BXRC-65E1001-D-7X	6500	80	350	1364	1200	25.3	8.9	154

Notes for Table 3:

- Nominal CCT as defined by ANSI C78.377-2011. Products with a CCT of 5000K-6500K are hot targeted to  $T_c = 85^\circ\text{C}$ .
- All CRI values are measured at  $T_c = T_f = 25^\circ\text{C}$ . CRI values are typical for Decor Series Ultra and Decor Series Class A products. CRI values are minimums for all other products. Minimum R<sub>g</sub> value for 80 CRI products is 0, the minimum R<sub>g</sub> values for 90 CRI products is 50, the minimum R<sub>g</sub> values for 97 CRI products is 93. Bridgelux maintains a  $\pm 3$  tolerance on R<sub>g</sub> values.
- Drive current is referred to as nominal drive current.
- Typical stabilized DC performance values are provided as reference only and are not a guarantee of performance.
- Typical performance is estimated based on operation under DC (direct current) with LED array mounted onto a heat sink with thermal interface material and the case temperature maintained at  $85^\circ\text{C}$ . Based on Bridgelux test setup, values may vary depending on the thermal design of the luminaire and/or the exposed environment to which the product is subjected.
- Minimum flux values at elevated temperatures are provided for reference only and are not guaranteed by 100% production testing. Based on Bridgelux test setup, values may vary depending on the thermal design of the luminaire and/or the exposed environment to which the product is subjected.
- Nominal CCT is defined by the Lighting Research Center's Class A definition. The center of the Class A color bin is on the corresponding isothermal line.
- GAI value is 80. To help ensure optimal fixture level performance, GAI is measured at the fixture level, on axis, at a case temperature of  $70^\circ\text{C}$ . GAI may vary depending on fixture design and performance.

# Performance at Commonly Used Drive Currents

Vero LED arrays are tested to the specifications shown using the nominal drive currents in Table 1. Vero may also be driven at other drive currents dependent on specific application design requirements. The performance at any drive current can be derived from the current vs. voltage characteristics shown in Figures 1, 2 & 3 and the flux vs. current characteristics shown in Figures 4, 5 & 6. The performance at commonly used drive currents is summarized in Table 4.

**Table 4:** Product Performance at Commonly Used Drive Currents

Part Number	CRI	Drive Current <sup>1</sup> (mA)	Typical $V_f$ $T_c = 25^\circ\text{C}$ (V)	Typical Power $T_c = 25^\circ\text{C}$ (W)	Typical Flux <sup>2</sup> $T_c = 25^\circ\text{C}$ (lm)	Typical DC Flux <sup>3</sup> $T_c = 85^\circ\text{C}$ (lm)	Typical Efficacy $T_c = 25^\circ\text{C}$ (lm/W)
BXRC-20B1001-B-73	65	135	33.2	4.5	708	636	158
		180	34.0	6.1	928	832	152
		<b>270</b>	<b>34.8</b>	<b>9.4</b>	<b>1328</b>	<b>1195</b>	<b>141</b>
		405	35.6	14.4	1948	1733	135
		540	36.1	19.5	2496	2209	128
BXRC-20B1001-D-73	65	175	24.9	4.4	686	623	157
		233	25.4	5.9	899	809	152
		<b>350</b>	<b>26.0</b>	<b>9.1</b>	<b>1284</b>	<b>1156</b>	<b>141</b>
		525	27.4	14.4	1890	1630	132
		700	28.4	19.9	2421	2039	122
BXRC-27E1000-B-7X	80	135	33.2	4.5	719	646	160
		180	34.0	6.1	942	845	154
		<b>270</b>	<b>34.8</b>	<b>9.4</b>	<b>1348</b>	<b>1214</b>	<b>144</b>
		405	35.6	14.4	1978	1760	137
		540	36.1	19.5	2534	2243	130
BXRC-27E1000-C-7X	80	180	33.2	6.0	955	853	160
		240	34.0	8.2	1252	1112	153
		<b>360</b>	<b>34.8</b>	<b>12.5</b>	<b>1797</b>	<b>1617</b>	<b>143</b>
		540	35.6	19.2	2617	2273	136
		720	36.1	26.0	3343	2861	128
BXRC-27E1000-D-7X	80	175	24.9	4.4	700	636	160
		233	25.4	5.9	918	825	155
		<b>350</b>	<b>26.0</b>	<b>9.1</b>	<b>1310</b>	<b>1179</b>	<b>144</b>
		525	27.4	14.4	1929	1664	134
		700	28.4	19.9	2471	2081	124
BXRC-27G1000-B-7X	90	135	33.2	4.5	599	538	134
		180	34.0	6.1	785	704	128
		<b>270</b>	<b>34.8</b>	<b>9.4</b>	<b>1124</b>	<b>1011</b>	<b>120</b>
		405	35.6	14.4	1648	1466	114
		540	36.1	19.5	2112	1869	108
BXRC-27G1000-C-7X	90	180	33.2	6.0	796	710	133
		240	34.0	8.2	1043	927	128
		<b>360</b>	<b>34.8</b>	<b>12.5</b>	<b>1498</b>	<b>1348</b>	<b>120</b>
		540	35.6	19.2	2181	1894	113
		720	36.1	26.0	2786	2385	107
BXRC-27G1000-D-7X	90	175	24.9	4.4	583	530	134
		233	25.4	5.9	765	688	129
		<b>350</b>	<b>26.0</b>	<b>9.1</b>	<b>1092</b>	<b>983</b>	<b>120</b>
		525	27.4	14.4	1607	1386	112
		700	28.4	19.9	2059	1734	104

Notes for Table 4:

1. Alternate drive currents are provided for reference only and are not a guarantee of performance.
2. Bridgelux maintains a  $\pm 7\%$  tolerance on flux measurements.
3. Typical stabilized DC performance values are provided as reference only and are not a guarantee of performance.

# Performance at Commonly Used Drive Currents

**Table 4:** Product Performance at Commonly Used Drive Currents (Continued)

Part Number	CRI	Drive Current <sup>1</sup> (mA)	Typical V <sub>f</sub> T <sub>c</sub> = 25°C (V)	Typical Power T <sub>c</sub> = 25°C (W)	Typical Flux <sup>2</sup> T <sub>c</sub> = 25°C (lm)	Typical DC Flux <sup>3</sup> T <sub>c</sub> = 85°C (lm)	Typical Efficacy T <sub>c</sub> = 25°C (lm/W)
BXRC-27H1000-B-7x	97	135	33.2	4.5	524	471	117
		180	34.0	6.1	687	617	112
		<b>270</b>	<b>34.8</b>	<b>9.4</b>	<b>984</b>	<b>886</b>	<b>105</b>
		405	35.6	14.4	1444	1284	100
		540	36.1	19.5	1849	1637	95
BXRC-27H1000-C-7x	97	180	33.2	6.0	697	622	117
		240	34.0	8.2	913	811	112
		<b>360</b>	<b>34.8</b>	<b>12.5</b>	<b>1311</b>	<b>1180</b>	<b>105</b>
		540	35.6	19.2	1909	1659	99
BXRC-27H1000-D-7x	97	720	36.1	26.0	2439	2088	94
		175	24.9	4.4	510	464	117
		233	25.4	5.9	670	602	113
		<b>350</b>	<b>26.0</b>	<b>9.1</b>	<b>956</b>	<b>860</b>	<b>105</b>
BXRC-30E1000-B-7X	80	525	27.4	14.4	1407	1214	98
		700	28.4	19.9	1803	1518	91
		135	33.2	4.5	755	679	168
		180	34.0	6.1	990	888	162
BXRC-30E1000-C-7X	80	<b>270</b>	<b>34.8</b>	<b>9.4</b>	<b>1418</b>	<b>1276</b>	<b>151</b>
		405	35.6	14.4	2080	1850	144
		540	36.1	19.5	2664	2358	137
		180	33.2	6.0	1005	897	168
		240	34.0	8.2	1316	1169	161
BXRC-30E1000-D-7X	80	<b>360</b>	<b>34.8</b>	<b>12.5</b>	<b>1890</b>	<b>1701</b>	<b>151</b>
		540	35.6	19.2	2752	2391	143
		720	36.1	26.0	3516	3009	135
		175	24.9	4.4	729	663	167
BXRC-30G1000-B-7X	90	233	25.4	5.9	956	860	162
		<b>350</b>	<b>26.0</b>	<b>9.1</b>	<b>1365</b>	<b>1229</b>	<b>150</b>
		525	27.4	14.4	2009	1733	140
		700	28.4	19.9	2574	2168	129
		135	33.2	4.5	621	558	139
BXRC-30G1000-C-7X	90	180	34.0	6.1	815	731	133
		<b>270</b>	<b>34.8</b>	<b>9.4</b>	<b>1166</b>	<b>1049</b>	<b>124</b>
		405	35.6	14.4	1710	1521	118
		540	36.1	19.5	2191	1939	112
		180	33.2	6.0	826	737	138
BXRC-30G1000-D-7X	90	240	34.0	8.2	1082	961	133
		<b>360</b>	<b>34.8</b>	<b>12.5</b>	<b>1554</b>	<b>1398</b>	<b>124</b>
		540	35.6	19.2	2262	1965	118
		720	36.1	26.0	2890	2474	111
BXRC-30G1000-D-7X	90	175	24.9	4.4	605	550	139
		233	25.4	5.9	794	714	134
		<b>350</b>	<b>26.0</b>	<b>9.1</b>	<b>1133</b>	<b>1020</b>	<b>125</b>
		525	27.4	14.4	1668	1438	116
		700	28.4	19.9	2137	1799	107

Notes for Table 4:

1. Alternate drive currents are provided for reference only and are not a guarantee of performance.
2. Bridgelux maintains a ± 7% tolerance on flux measurements.
3. Typical stabilized DC performance values are provided as reference only and are not a guarantee of performance.

# Performance at Commonly Used Drive Currents

**Table 4:** Product Performance at Commonly Used Drive Currents (Continued)

Part Number	CRI	Drive Current <sup>1</sup> (mA)	Typical $V_f$ $T_c = 25^\circ\text{C}$ (V)	Typical Power $T_c = 25^\circ\text{C}$ (W)	Typical Flux <sup>2</sup> $T_c = 25^\circ\text{C}$ (lm)	Typical DC Flux <sup>3</sup> $T_c = 85^\circ\text{C}$ (lm)	Typical Efficacy $T_c = 25^\circ\text{C}$ (lm/W)
BXRC-30G100C-B-73	90	135	33.2	4.5	582	523	130
		180	34.0	6.1	763	684	125
		<b>270</b>	<b>34.8</b>	<b>9.4</b>	<b>1092</b>	<b>983</b>	<b>116</b>
		405	35.6	14.4	1602	1425	111
		540	36.1	19.5	2052	1817	105
BXRC-30G100C-D-73	90	175	24.9	4.4	564	513	129
		233	25.4	5.9	740	665	125
		<b>350</b>	<b>26.0</b>	<b>9.1</b>	<b>1056</b>	<b>950</b>	<b>116</b>
		525	27.4	14.4	1554	1341	108
		700	28.4	19.9	1991	1677	100
BXRC-30H1000-B-7x	97	135	33.2	4.5	561	505	125
		180	34.0	6.1	736	660	120
		<b>270</b>	<b>34.8</b>	<b>9.4</b>	<b>1054</b>	<b>948</b>	<b>112</b>
		405	35.6	14.4	1546	1375	107
		540	36.1	19.5	1980	1753	101
BXRC-30H1000-C-7x	97	180	33.2	6.0	747	666	125
		240	34.0	8.2	978	869	120
		<b>360</b>	<b>34.8</b>	<b>12.5</b>	<b>1404</b>	<b>1264</b>	<b>112</b>
		540	35.6	19.2	2045	1776	106
		720	36.1	26.0	2612	2236	100
BXRC-30H1000-D-7x	97	175	24.9	4.4	547	497	125
		233	25.4	5.9	717	645	121
		<b>350</b>	<b>26.0</b>	<b>9.1</b>	<b>1024</b>	<b>922</b>	<b>113</b>
		525	27.4	14.4	1507	1300	105
		700	28.4	19.9	1931	1626	97
BXRC-30A1001-B-73	93	135	33.2	4.5	579	520	129
		180	34.0	6.1	759	681	124
		<b>270</b>	<b>34.8</b>	<b>9.4</b>	<b>1086</b>	<b>977</b>	<b>116</b>
		405	35.6	14.4	1593	1417	110
		540	36.1	19.5	2041	1807	105
BXRC-30A1001-C-73	93	180	33.2	6.0	770	687	129
		240	34.0	8.2	1009	896	124
		<b>360</b>	<b>34.8</b>	<b>12.5</b>	<b>1448</b>	<b>1303</b>	<b>116</b>
		540	35.6	19.2	2108	1832	110
		720	36.1	26.0	2693	2306	103
BXRC-30A1001-D-73	93	175	24.9	4.4	564	513	129
		233	25.4	5.9	740	665	125
		<b>350</b>	<b>26.0</b>	<b>9.1</b>	<b>1056</b>	<b>950</b>	<b>116</b>
		525	27.4	14.4	1554	1341	108
		700	28.4	19.9	1991	1677	100
BXRC-35E1000-B-7X	80	135	33.2	4.5	771	693	172
		180	34.0	6.1	1011	907	165
		<b>270</b>	<b>34.8</b>	<b>9.4</b>	<b>1447</b>	<b>1302</b>	<b>154</b>
		405	35.6	14.4	2122	1888	147
		540	36.1	19.5	2719	2407	139

Notes for Table 4:

1. Alternate drive currents are provided for reference only and are not a guarantee of performance.
2. Bridgelux maintains a  $\pm 7\%$  tolerance on flux measurements.
3. Typical stabilized DC performance values are provided as reference only and are not a guarantee of performance.

# Performance at Commonly Used Drive Currents

**Table 4:** Product Performance at Commonly Used Drive Currents (Continued)

Part Number	CRI	Drive Current <sup>1</sup> (mA)	Typical $V_f$ $T_c = 25^\circ\text{C}$ (V)	Typical Power $T_c = 25^\circ\text{C}$ (W)	Typical Flux <sup>2</sup> $T_c = 25^\circ\text{C}$ (lm)	Typical DC Flux <sup>3</sup> $T_c = 85^\circ\text{C}$ (lm)	Typical Efficacy $T_c = 25^\circ\text{C}$ (lm/W)
BXRC-35E1000-C-7X	80	180	33.2	6.0	1025	915	171
		240	34.0	8.2	1343	1193	165
		<b>360</b>	<b>34.8</b>	<b>12.5</b>	<b>1928</b>	<b>1735</b>	<b>154</b>
		540	35.6	19.2	2808	2439	146
		720	36.1	26.0	3586	3070	138
BXRC-35E1000-D-7X	80	175	24.9	4.4	751	683	172
		233	25.4	5.9	985	885	166
		<b>350</b>	<b>26.0</b>	<b>9.1</b>	<b>1406</b>	<b>1265</b>	<b>155</b>
		525	27.4	14.4	2069	1785	144
		700	28.4	19.9	2651	2233	133
BXRC-35G1000-B-7X	90	135	33.2	4.5	644	578	144
		180	34.0	6.1	844	757	138
		<b>270</b>	<b>34.8</b>	<b>9.4</b>	<b>1208</b>	<b>1087</b>	<b>129</b>
		405	35.6	14.4	1772	1576	123
		540	36.1	19.5	2270	2009	116
BXRC-35G1000-C-7X	90	180	33.2	6.0	856	764	143
		240	34.0	8.2	1121	996	137
		<b>360</b>	<b>34.8</b>	<b>12.5</b>	<b>1610</b>	<b>1449</b>	<b>129</b>
		540	35.6	19.2	2344	2037	122
		720	36.1	26.0	2995	2563	115
BXRC-35G1000-D-7X	90	175	24.9	4.4	627	570	144
		233	25.4	5.9	822	739	139
		<b>350</b>	<b>26.0</b>	<b>9.1</b>	<b>1174</b>	<b>1057</b>	<b>129</b>
		525	27.4	14.4	1728	1490	120
		700	28.4	19.9	2214	1864	111
BXRC-35A1001-B-73	93	135	33.2	4.5	623	560	139
		180	34.0	6.1	817	733	134
		<b>270</b>	<b>34.8</b>	<b>9.4</b>	<b>1170</b>	<b>1053</b>	<b>125</b>
		405	35.6	14.4	1716	1527	119
		540	36.1	19.5	2199	1946	113
BXRC-35A1001-C-73	93	180	33.2	6.0	829	740	139
		240	34.0	8.2	1087	965	133
		<b>360</b>	<b>34.8</b>	<b>12.5</b>	<b>1560</b>	<b>1404</b>	<b>125</b>
		540	35.6	19.2	2272	1973	118
		720	36.1	26.0	2902	2484	112
BXRC-35A1001-D-73	93	175	24.9	4.4	608	552	139
		233	25.4	5.9	797	717	135
		<b>350</b>	<b>26.0</b>	<b>9.1</b>	<b>1138</b>	<b>1024</b>	<b>125</b>
		525	27.4	14.4	1675	1445	117
		700	28.4	19.9	2146	1807	108
BXRC-40E1000-B-7X	80	135	33.2	4.5	778	700	174
		180	34.0	6.1	1021	915	167
		<b>270</b>	<b>34.8</b>	<b>9.4</b>	<b>1461</b>	<b>1315</b>	<b>155</b>
		405	35.6	14.4	2143	1906	148
		540	36.1	19.5	2745	2430	141

Notes for Table 4:

1. Alternate drive currents are provided for reference only and are not a guarantee of performance.
2. Bridgelux maintains a  $\pm 7\%$  tolerance on flux measurements.
3. Typical stabilized DC performance values are provided as reference only and are not a guarantee of performance.

# Performance at Commonly Used Drive Currents

**Table 4:** Product Performance at Commonly Used Drive Currents (Continued)

Part Number	CRI	Drive Current <sup>1</sup> (mA)	Typical $V_f$ $T_c = 25^\circ\text{C}$ (V)	Typical Power $T_c = 25^\circ\text{C}$ (W)	Typical Flux <sup>2</sup> $T_c = 25^\circ\text{C}$ (lm)	Typical DC Flux <sup>3</sup> $T_c = 85^\circ\text{C}$ (lm)	Typical Efficacy $T_c = 25^\circ\text{C}$ (lm/W)
BXRC-40E1000-C-7X	80	180	33.2	6.0	1035	924	173
		240	34.0	8.2	1356	1205	166
		<b>360</b>	<b>34.8</b>	<b>12.5</b>	<b>1947</b>	<b>1752</b>	<b>155</b>
		540	35.6	19.2	2835	2463	147
BXRC-40E1000-D-7X	80	720	36.1	26.0	3621	3100	139
		175	24.9	4.4	758	689	174
		233	25.4	5.9	994	894	168
		<b>350</b>	<b>26.0</b>	<b>9.1</b>	<b>1420</b>	<b>1278</b>	<b>156</b>
BXRC-40G1000-B-7X	90	525	27.4	14.4	2090	1802	145
		700	28.4	19.9	2677	2254	135
		135	33.2	4.5	666	599	149
		180	34.0	6.1	873	783	143
BXRC-40G1000-C-7X	90	<b>270</b>	<b>34.8</b>	<b>9.4</b>	<b>1250</b>	<b>1125</b>	<b>133</b>
		405	35.6	14.4	1834	1631	127
		540	36.1	19.5	2349	2079	120
		180	33.2	6.0	886	790	148
BXRC-40G1000-D-7X	90	240	34.0	8.2	1160	1031	142
		<b>350</b>	<b>26.0</b>	<b>9.1</b>	<b>1215</b>	<b>1093</b>	<b>134</b>
		525	27.4	14.4	1788	1542	124
		700	28.4	19.9	2291	1929	115
BXRC-40A1001-B-73	93	135	33.2	4.5	663	596	148
		180	34.0	6.1	870	780	142
		<b>270</b>	<b>34.8</b>	<b>9.4</b>	<b>1245</b>	<b>1121</b>	<b>133</b>
		405	35.6	14.4	1827	1625	127
BXRC-40A1001-C-73	93	540	36.1	19.5	2340	2071	120
		180	33.2	6.0	883	788	148
		240	34.0	8.2	1156	1027	142
		<b>360</b>	<b>34.8</b>	<b>12.5</b>	<b>1660</b>	<b>1494</b>	<b>133</b>
BXRC-40A1001-D-73	93	540	35.6	19.2	2417	2100	126
		720	36.1	26.0	3088	2643	119
		175	24.9	4.4	646	587	148
		233	25.4	5.9	848	762	143
BXRC-50C1001-B-7X	70	<b>350</b>	<b>26.0</b>	<b>9.1</b>	<b>1210</b>	<b>1089</b>	<b>133</b>
		525	27.4	14.4	1781	1536	124
		700	28.4	19.9	2282	1921	115
		135	33.2	4.5	853	767	190
BXRC-50C1001-B-7X	70	180	34.0	6.1	1119	1003	183
		<b>270</b>	<b>34.8</b>	<b>9.4</b>	<b>1601</b>	<b>1441</b>	<b>170</b>
		405	35.6	14.4	2349	2090	163
		540	36.1	19.5	3009	2664	154

Notes for Table 4:

1. Alternate drive currents are provided for reference only and are not a guarantee of performance.
2. Bridgelux maintains a  $\pm 7\%$  tolerance on flux measurements.
3. Typical stabilized DC performance values are provided as reference only and are not a guarantee of performance.

# Performance at Commonly Used Drive Currents

**Table 4:** Product Performance at Commonly Used Drive Currents (Continued)

Part Number	CRI	Drive Current <sup>1</sup> (mA)	Typical V <sub>f</sub> T <sub>c</sub> = 25°C (V)	Typical Power T <sub>c</sub> = 25°C (W)	Typical Flux <sup>2</sup> T <sub>c</sub> = 25°C (lm)	Typical DC Flux <sup>3</sup> T <sub>c</sub> = 85°C (lm)	Typical Efficacy T <sub>c</sub> = 25°C (lm/W)
BXRC-50C1001-C-7x	70	180	33.2	6.0	1135	1012	190
		240	34.0	8.2	1486	1321	182
		<b>360</b>	<b>34.8</b>	<b>12.5</b>	<b>2134</b>	<b>1921</b>	<b>170</b>
		540	35.6	19.2	3108	2700	161
BXRC-50C1001-D-7x	70	720	36.1	26.0	3970	3398	153
		175	24.9	4.4	831	755	190
		233	25.4	5.9	1090	980	184
		<b>350</b>	<b>26.0</b>	<b>9.1</b>	<b>1556</b>	<b>1400</b>	<b>171</b>
BXRC-50E1001-B-7x	80	525	27.4	14.4	2290	1975	159
		700	28.4	19.9	2934	2471	148
		135	33.2	4.5	802	721	179
		180	34.0	6.1	1052	943	172
BXRC-50E1001-B-7x	80	<b>270</b>	<b>34.8</b>	<b>9.4</b>	<b>1505</b>	<b>1355</b>	<b>160</b>
		405	35.6	14.4	2208	1964	153
		540	36.1	19.5	2829	2504	145
		180	33.2	6.0	1067	952	178
BXRC-50E1001-C-7x	80	240	34.0	8.2	1397	1241	171
		<b>360</b>	<b>34.8</b>	<b>12.5</b>	<b>2006</b>	<b>1805</b>	<b>160</b>
		540	35.6	19.2	2921	2538	152
		720	36.1	26.0	3731	3194	143
BXRC-50E1001-D-7x	80	175	24.9	4.4	781	710	179
		233	25.4	5.9	1025	921	173
		<b>350</b>	<b>26.0</b>	<b>9.1</b>	<b>1463</b>	<b>1316</b>	<b>161</b>
		525	27.4	14.4	2153	1857	150
BXRC-50E1001-D-7x	80	700	28.4	19.9	2758	2323	139
		135	33.2	4.5	683	613	152
		180	34.0	6.1	895	803	146
		<b>270</b>	<b>34.8</b>	<b>9.4</b>	<b>1281</b>	<b>1153</b>	<b>136</b>
BXRC-50G1001-B-7x	90	405	35.6	14.4	1879	1672	130
		540	36.1	19.5	2408	2131	123
		180	33.2	6.0	908	810	152
		240	34.0	8.2	1189	1056	146
BXRC-50G1001-C-7x	90	<b>360</b>	<b>34.8</b>	<b>12.5</b>	<b>1707</b>	<b>1537</b>	<b>136</b>
		540	35.6	19.2	2486	2160	129
		720	36.1	26.0	3176	2718	122
		175	24.9	4.4	665	604	152
BXRC-50G1001-D-7x	90	233	25.4	5.9	872	784	147
		<b>350</b>	<b>26.0</b>	<b>9.1</b>	<b>1245</b>	<b>1120</b>	<b>137</b>
		525	27.4	14.4	1832	1580	127
		700	28.4	19.9	2348	1977	118
BXRC-57C1001-B-7x	70	135	33.2	4.5	823	740	184
		180	34.0	6.1	1079	968	176
		<b>270</b>	<b>34.8</b>	<b>9.4</b>	<b>1545</b>	<b>1390</b>	<b>164</b>
		405	35.6	14.4	2267	2016	157
BXRC-57C1001-B-7x	70	540	36.1	19.5	2904	2570	149

Notes for Table 4:

1. Alternate drive currents are provided for reference only and are not a guarantee of performance.
2. Bridgelux maintains a ± 7% tolerance on flux measurements.
3. Typical stabilized DC performance values are provided as reference only and are not a guarantee of performance.

# Performance at Commonly Used Drive Currents

**Table 4:** Product Performance at Commonly Used Drive Currents (Continued)

Part Number	CRI	Drive Current <sup>1</sup> (mA)	Typical V <sub>f</sub> T <sub>c</sub> = 25°C (V)	Typical Power T <sub>c</sub> = 25°C (W)	Typical Flux <sup>2</sup> T <sub>c</sub> = 25°C (lm)	Typical DC Flux <sup>3</sup> T <sub>c</sub> = 85°C (lm)	Typical Efficacy T <sub>c</sub> = 25°C (lm/W)
BXRC-57C1001-C-7x	70	180	33.2	6.0	1095	977	183
		240	34.0	8.2	1434	1274	176
		<b>360</b>	<b>34.8</b>	<b>12.5</b>	<b>2059</b>	<b>1853</b>	<b>164</b>
		540	35.6	19.2	2998	2605	156
BXRC-57C1001-D-7x	70	720	36.1	26.0	3830	3279	147
		175	24.9	4.4	802	729	184
		233	25.4	5.9	1052	946	178
		<b>350</b>	<b>26.0</b>	<b>9.1</b>	<b>1502</b>	<b>1351</b>	<b>165</b>
BXRC-57E1001-B-7x	80	525	27.4	14.4	2210	1906	154
		700	28.4	19.9	2832	2384	142
		135	33.2	4.5	816	733	182
		180	34.0	6.1	1070	959	175
BXRC-57E1001-C-7x	80	<b>270</b>	<b>34.8</b>	<b>9.4</b>	<b>1531</b>	<b>1378</b>	<b>163</b>
		405	35.6	14.4	2246	1998	156
		540	36.1	19.5	2877	2547	147
		180	33.2	6.0	1085	968	181
BXRC-57E1001-D-7x	80	240	34.0	8.2	1421	1263	174
		<b>360</b>	<b>34.8</b>	<b>12.5</b>	<b>2040</b>	<b>1836</b>	<b>163</b>
		540	35.6	19.2	2971	2581	154
		720	36.1	26.0	3795	3249	146
BXRC-65C1001-B-7x	70	175	24.9	4.4	794	722	182
		233	25.4	5.9	1042	937	176
		<b>350</b>	<b>26.0</b>	<b>9.1</b>	<b>1488</b>	<b>1339</b>	<b>164</b>
		525	27.4	14.4	2190	1889	152
BXRC-65C1001-C-7x	70	700	28.4	19.9	2806	2363	141
		135	33.2	4.5	838	753	187
		180	34.0	6.1	1099	986	180
		<b>270</b>	<b>34.8</b>	<b>9.4</b>	<b>1573</b>	<b>1416</b>	<b>167</b>
BXRC-65C1001-D-7x	70	405	35.6	14.4	2308	2053	160
		540	36.1	19.5	2957	2617	151
		180	33.2	6.0	1115	995	186
		240	34.0	8.2	1460	1297	179
BXRC-65E1001-B-7x	80	<b>360</b>	<b>34.8</b>	<b>12.5</b>	<b>2097</b>	<b>1887</b>	<b>167</b>
		540	35.6	19.2	3053	2652	159
		720	36.1	26.0	3900	3338	150
		175	24.9	4.4	816	742	187
BXRC-65E1001-C-7x	70	233	25.4	5.9	1071	963	181
		<b>350</b>	<b>26.0</b>	<b>9.1</b>	<b>1529</b>	<b>1376</b>	<b>168</b>
		525	27.4	14.4	2250	1941	157
		700	28.4	19.9	2883	2428	145
BXRC-65E1001-D-7x	80	135	33.2	4.5	831	747	185
		180	34.0	6.1	1089	977	178
		<b>270</b>	<b>34.8</b>	<b>9.4</b>	<b>1559</b>	<b>1403</b>	<b>166</b>
		405	35.6	14.4	2287	2035	158
BXRC-65E1001-E-7x	80	540	36.1	19.5	2930	2593	150

Notes for Table 4:

1. Alternate drive currents are provided for reference only and are not a guarantee of performance.
2. Bridgelux maintains a ± 7% tolerance on flux measurements.
3. Typical stabilized DC performance values are provided as reference only and are not a guarantee of performance.



# Performance at Commonly Used Drive Currents

**Table 4:** Product Performance at Commonly Used Drive Currents (Continued)

Part Number	CRI	Drive Current <sup>1</sup> (mA)	Typical $V_f$ $T_c = 25^\circ\text{C}$ (V)	Typical Power $T_c = 25^\circ\text{C}$ (W)	Typical Flux <sup>2</sup> $T_c = 25^\circ\text{C}$ (lm)	Typical DC Flux <sup>3</sup> $T_c = 85^\circ\text{C}$ (lm)	Typical Efficacy $T_c = 25^\circ\text{C}$ (lm/W)
BXRC-65E1001-C-7x	80	180	33.2	6.0	1105	986	185
		240	34.0	8.2	1447	1286	177
		<b>360</b>	<b>34.8</b>	<b>12.5</b>	<b>2078</b>	<b>1870</b>	<b>166</b>
		540	35.6	19.2	3026	2629	157
		720	36.1	26.0	3865	3309	149
BXRC-65E1001-D-7x	80	175	24.9	4.4	809	736	185
		233	25.4	5.9	1061	954	179
		<b>350</b>	<b>26.0</b>	<b>9.1</b>	<b>1515</b>	<b>1364</b>	<b>167</b>
		525	27.4	14.4	2230	1923	155
		700	28.4	19.9	2857	2406	144

Notes for Table 4:

1. Alternate drive currents are provided for reference only and are not a guarantee of performance.
2. Bridgelux maintains a  $\pm 7\%$  tolerance on flux measurements.
3. Typical stabilized DC performance values are provided as reference only and are not a guarantee of performance.

# Electrical Characteristics

**Table 5:** Electrical Characteristics

Part Number	Drive Current (mA)	Forward Voltage Pulsed, $T_c = 25^\circ\text{C}$ (V) <sup>1, 2, 3, 8</sup>			Typical Coefficient of Forward Voltage <sup>4</sup> $\Delta V_f / \Delta T_c$ (mV/ $^\circ\text{C}$ )	Typical Thermal Resistance Junction to Case <sup>5,6</sup> $R_{j-c}$ ( $^\circ\text{C}/\text{W}$ )	Driver Selection Voltages <sup>7</sup> (V)	
		Minimum	Typical	Maximum			$V_f$ Min. Hot $T_c = 105^\circ\text{C}$ (V)	$V_f$ Max. Cold $T_c = -40^\circ\text{C}$ (V)
BXRC-xxx100x-B-7x	270	32.2	34.8	37.4	-16.1	0.49	30.9	38.5
	540	33.4	36.1	38.8	-16.1	0.56	32.1	39.9
BXRC-xxx100x-C-7x	360	32.2	34.8	37.4	-16.1	0.37	30.9	38.5
	720	33.4	36.1	38.8	-16.1	0.45	32.1	39.9
BXRC-xxx100x-D-7x	350	24.1	26.0	28.0	-11.8	0.49	23.1	28.7
	700	26.3	28.4	30.5	-11.8	0.57	25.3	31.3

Notes for Table 5:

- Parts are tested in pulsed conditions,  $T_c = 25^\circ\text{C}$ . Pulse width is 10ms.
- Voltage minimum and maximum are provided for reference only and are not a guarantee of performance.
- Bridgelux maintains a tester tolerance of  $\pm 0.10\text{V}$  on forward voltage measurements.
- Typical coefficient of forward voltage tolerance is  $\pm 0.1\text{mV}$  for nominal current.
- Thermal resistance values are based from test data of a 3000K 80 CRI product.
- Thermal resistance value was calculated using total electrical input power; optical power was not subtracted from input power. The thermal interface material used during testing is not included in the thermal resistance value.
- $V_f$  min hot and max cold values are provided as reference only and are not guaranteed by test. These values are provided to aid in driver design and selection over the operating range of the product.
- This product has been designed and manufactured per IEC 62031:2014. This product has passed dielectric withstand voltage testing at 1160 V. The working voltage designated for the insulation is 80V d.c. The maximum allowable voltage across the array must be determined in the end product application.

# Eye Safety

**Table 6:** Eye Safety Risk Group (RG) Classifications

Part Number	Drive Current <sup>5</sup> (mA)	CCT <sup>1-5</sup>			
		2700K/3000K	4000K <sup>2</sup>	5000K <sup>3</sup>	6500K <sup>4</sup>
BXRC-xxx100x-B-7x	270	RG1	RG1	RG1	RG1
	405	RG1	RG1	RG1	RG2
	540	RG1	RG1	RG2	RG2
BXRC-xxx100x-C-7x	360	RG1	RG1	RG1	RG2
	540	RG1	RG1	RG2	RG2
	720	RG1	RG2	RG2	RG2
BXRC-xxx100x-D-7x	350	RG1	RG1	RG1	RG1
	525	RG1	RG1	RG1	RG2
	700	RG1	RG1	RG2	RG2

Notes for Table 6:

1. Eye safety classification for the use of Bridgelux Vero Series LED arrays is in accordance with specification IEC/TR 62778: Application of IEC 62471 for the assessment of blue light hazard to light sources and luminaires.
2. For products classified as RG2 at 4000K,  $E_{thr} = 1847.5$  lx.
3. For products classified as RG2 at 5000K  $E_{thr} = 1315.8$  lx.
4. For products classified as RG2 at 6500K,  $E_{thr} = 1124.5$  lx.
5. Please contact your Bridgelux sales representative for  $E_{thr}$  values at specific drive currents and CCTs not listed.

# Absolute Maximum Ratings

**Table 7:** Maximum Ratings

Parameter	Maximum Rating		
LED Junction Temperature ( $T_j$ )	125°C		
Storage Temperature	-40°C to +105°C		
Operating Case Temperature <sup>1</sup> ( $T_c$ )	105°C		
Soldering Temperature <sup>2</sup>	300°C or lower for a maximum of 6 seconds		
	BXRC-xxx100x-B-7x	BXRC-xxx100x-C-7x	BXRC-xxx100x-D-7x
Maximum Drive Current <sup>3</sup>	540mA	720mA	700mA
Maximum Peak Pulsed Drive Current <sup>4</sup>	770mA	1030mA	1000mA
Maximum Reverse Voltage <sup>5</sup>	-60V	-60V	-45V

Notes for Table 7:

1. For IEC 62717 requirement, please consult your Bridgelux sales representative.
2. Refer to Bridgelux Application Note AN31: Assembly Considerations for Bridgelux Vero LED Arrays.
3. Arrays may be driven at higher currents however lumen maintenance may be reduced.
4. Bridgelux recommends a maximum duty cycle of 10% and pulse width of 20 ms when operating LED Arrays at maximum peak pulsed current specified. Maximum peak pulsed currents indicate values where LED Arrays can be driven without catastrophic failures.
5. Light emitting diodes are not designed to be driven in reverse voltage and will not produce light under this condition. Maximum rating provided for reference only.

# Performance Curves

**Figure 1: Vero 10B Drive Current vs. Voltage**

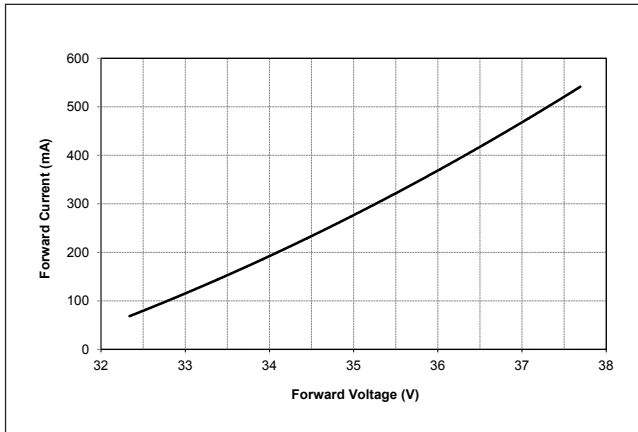

**Figure 2: Vero 10C Drive Current vs. Voltage**

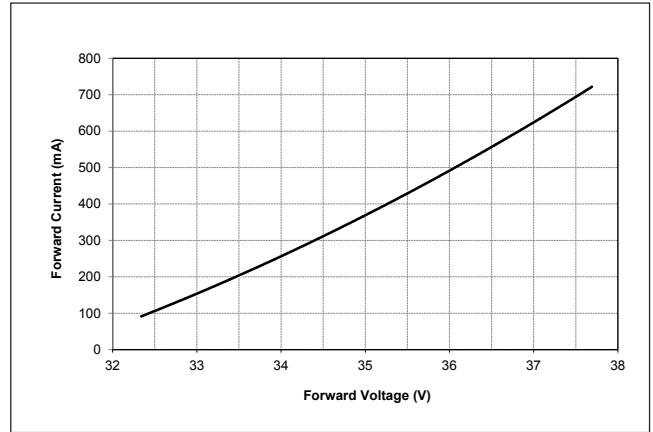

**Figure 3: Vero 10D Drive Current vs. Voltage**

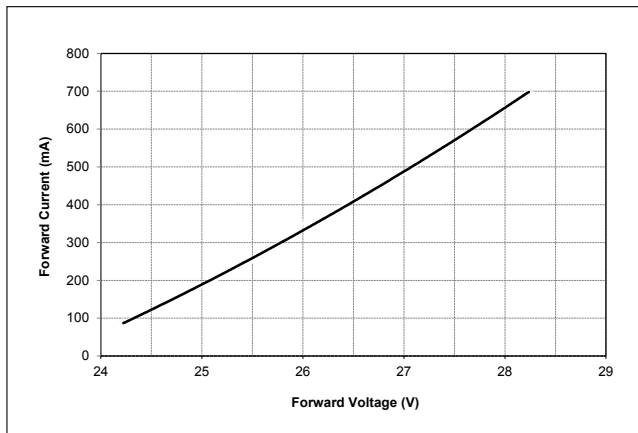

**Figure 4: Vero 10B Typical Relative Flux vs. Current**

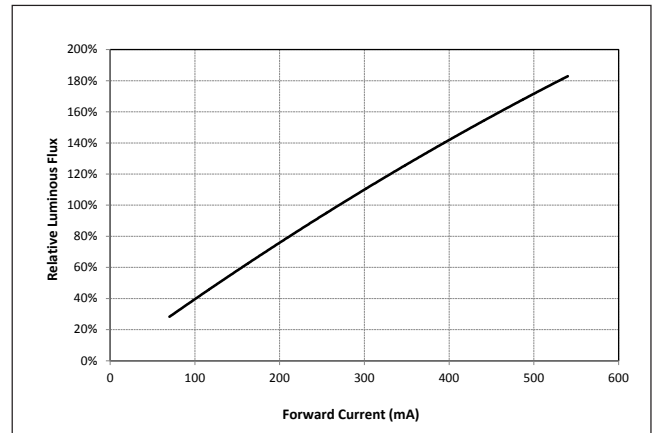

**Figure 5: Vero 10C Typical Relative Flux vs. Current**

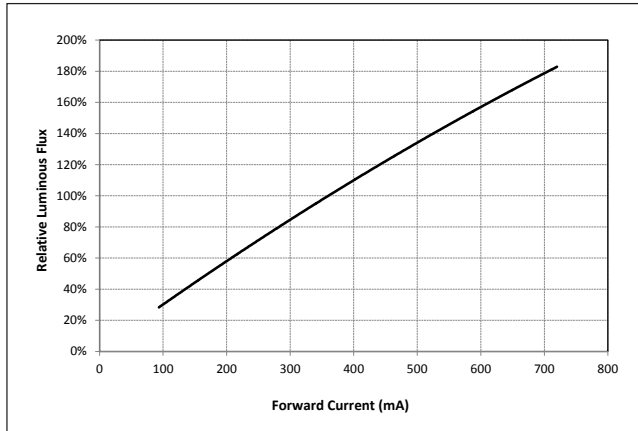

**Figure 6: Vero 10D Typical Relative Flux vs. Current**

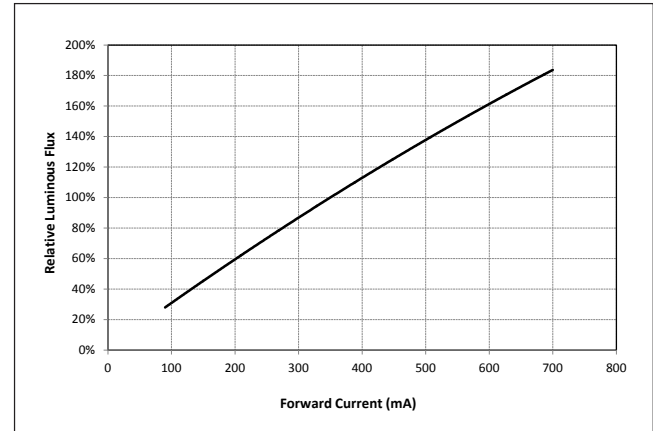

Notes for Figure 1-6:

1. Bridgelux does not recommend driving high power LEDs at low currents. Doing so may produce unpredictable results. Pulse width modulation (PWM) is recommended for dimming effects.
2. Products tested under pulsed condition (10ms pulse width) at nominal test current where  $T_j$  (junction temperature) =  $T_c$  (case temperature) = 25°C.

# Performance Curves

**Figure 7: Typical DC Flux vs. Case Temperature**

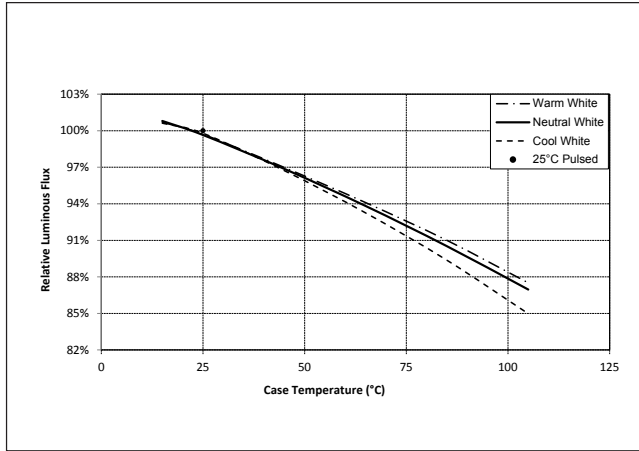

**Figure 8: Typical DC ccy Shift vs. Case Temperature**

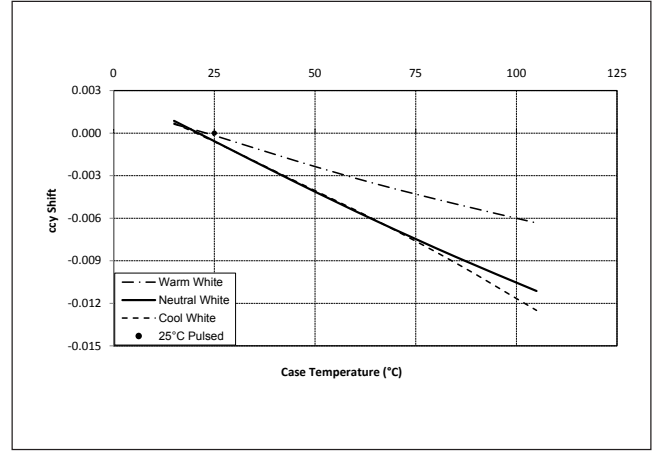

**Figure 9: Typical DC ccx Shift vs. Case Temperature**

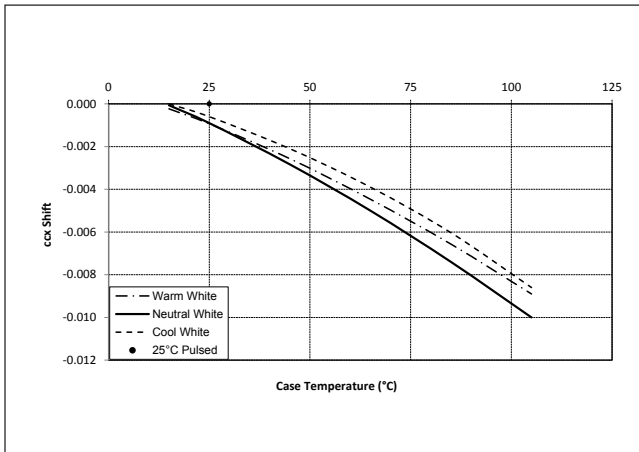

**Figure 10: 2000K, 65 CRI Color Shift vs. Case Temperature**

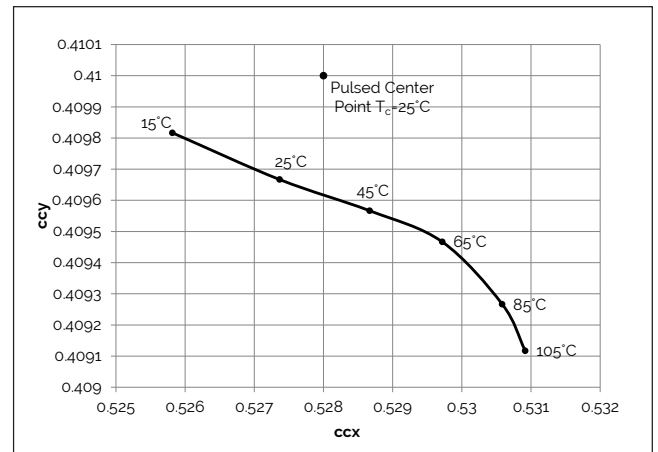

Notes for Figures 7 - 9:

1. Characteristics shown for warm white based on 3000K and 80 CRI.
2. Characteristics shown for neutral white based on 4000K and 80 CRI.
3. Characteristics shown for cool white based on 5000K and 70 CRI.
4. For other color SKUs, the shift in color will vary. Please contact your Bridgelux Sales Representative for more information.

# Performance Curves

**Figure 11: 2700K, 97 CRI Color Shift vs. Case Temperature<sup>1</sup>**

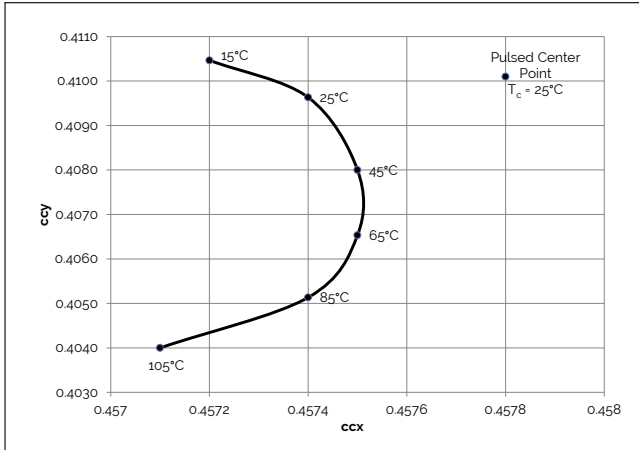

**Figure 12: 3000K, 97 CRI Color Shift vs. Case Temperature<sup>1</sup>**

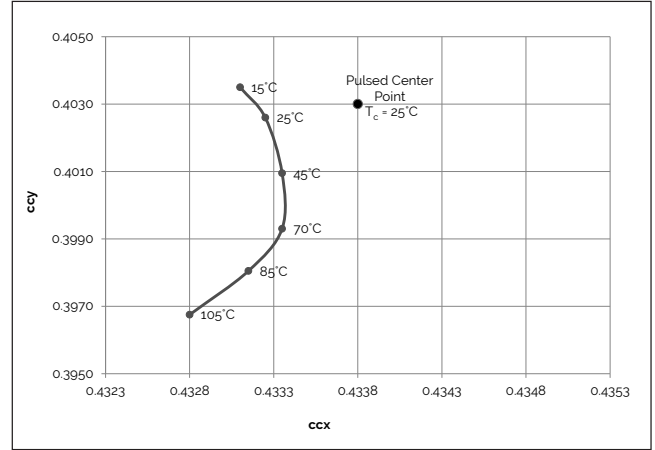

**Figure 13: 3000K, 90 CRI Color Shift vs. Case Temperature<sup>3</sup>**

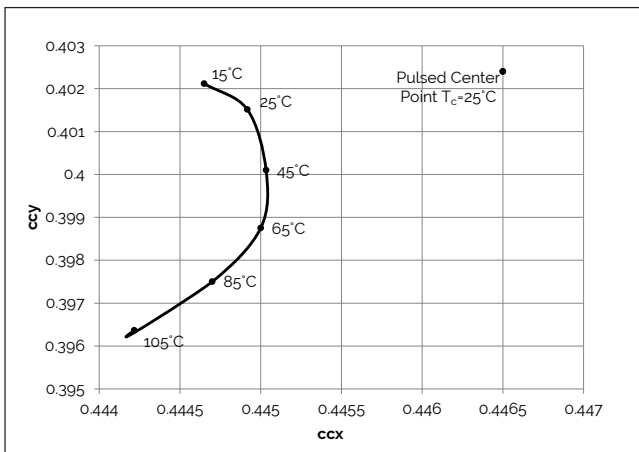

**Figure 14: 3000K Class A Color Shift vs. Case Temperature<sup>1</sup>**

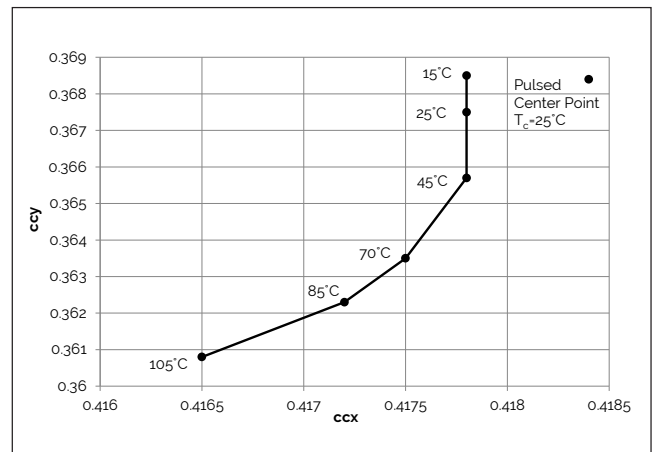

**Figure 15: 3500K Class A Color Shift vs. Case Temperature<sup>1</sup>**

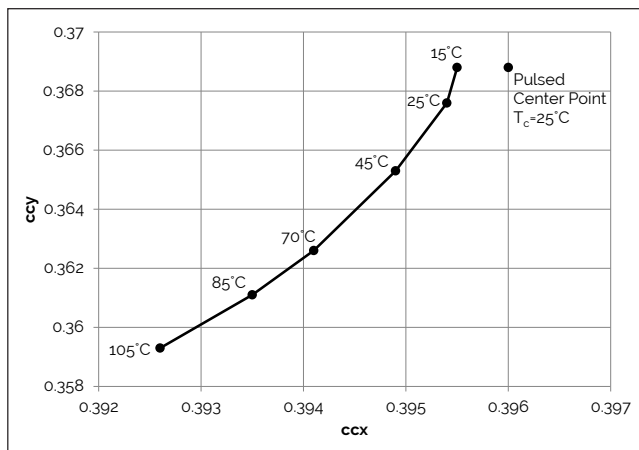

**Figure 16: 4000K Class A Color Shift vs. Case Temperature<sup>1</sup>**

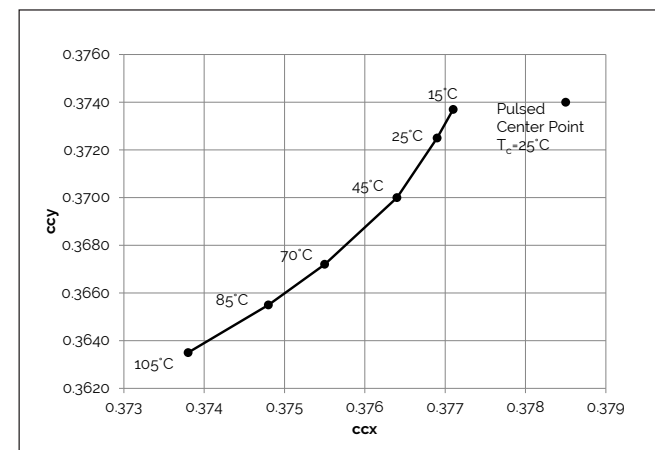

Note for Figures 10-16:

1. Measurements made under DC test conditions at the nominal drive current.
2. Typical color shift is shown with a tolerance of  $\pm 0.002$ .
3. Characteristics shown for Decor Series Showcase products, BXRC-30G100C-x-73

# Typical Radiation Pattern

Figure 17: Typical Spatial Radiation Pattern

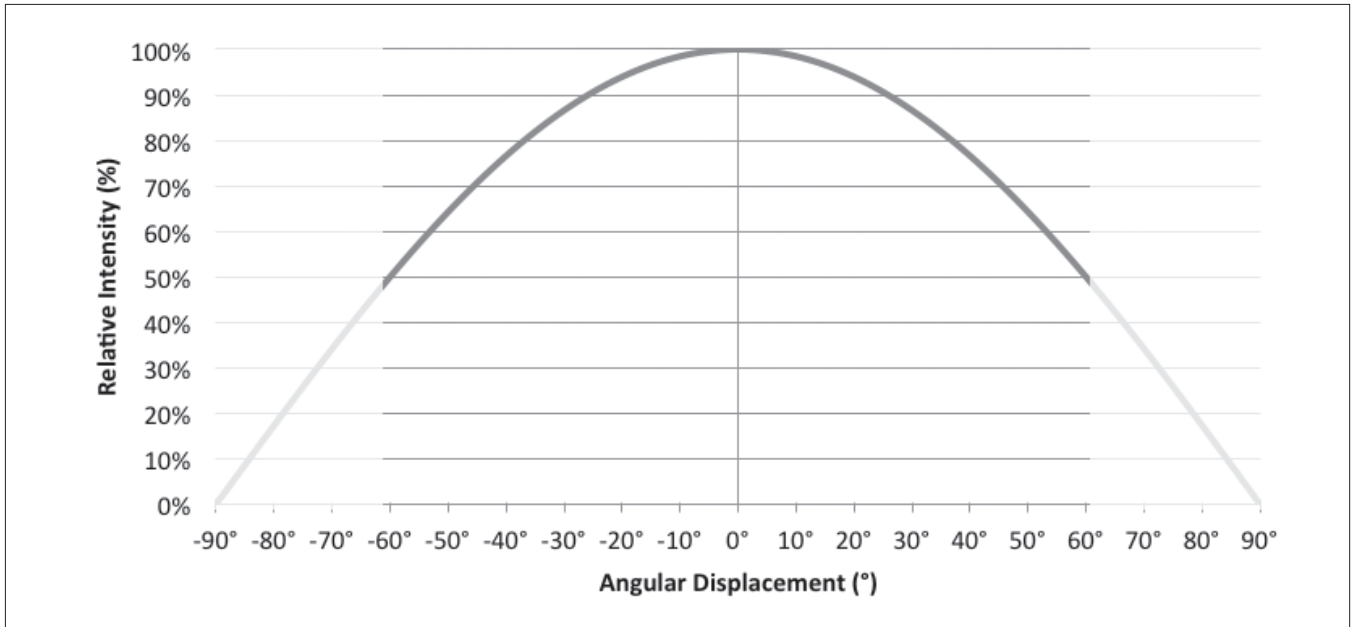

Note for Figure 17:

1. Typical viewing angle is 120°.
2. The viewing angle is defined as the off axis angle from the centerline where intensity is ½ of the peak value.

Figure 18: Typical Polar Radiation Pattern

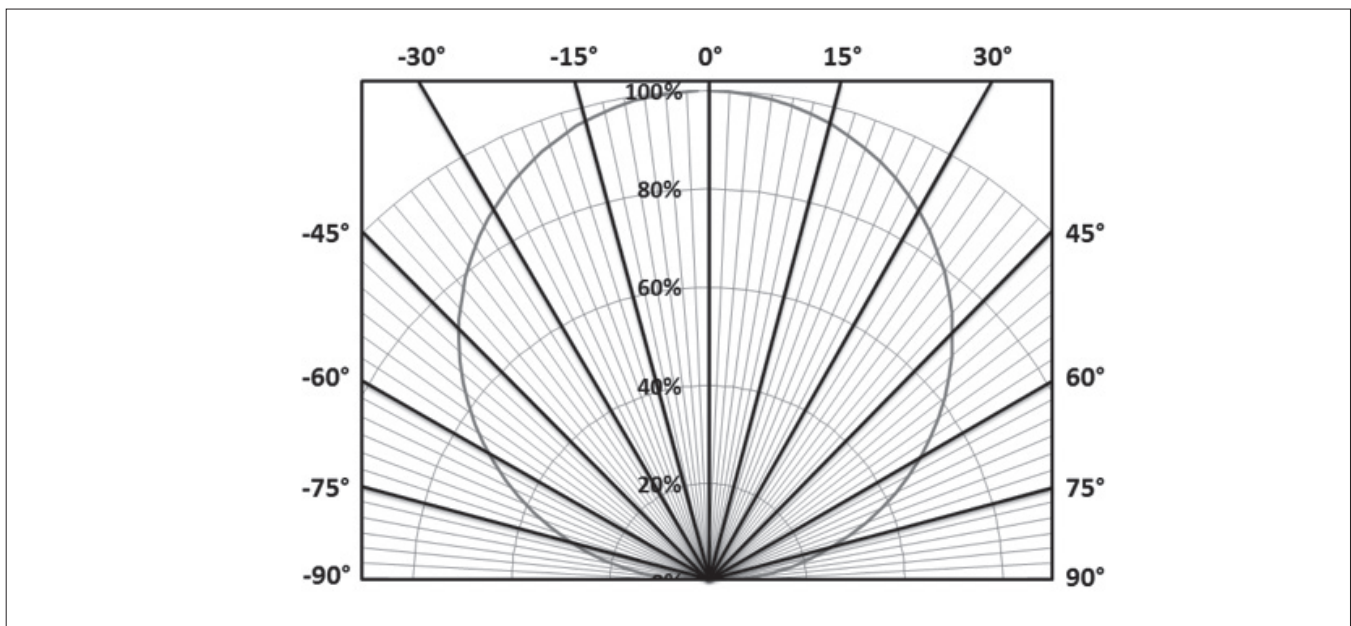



# Typical Color Spectrum

Figure 19: Typical Color Spectrum

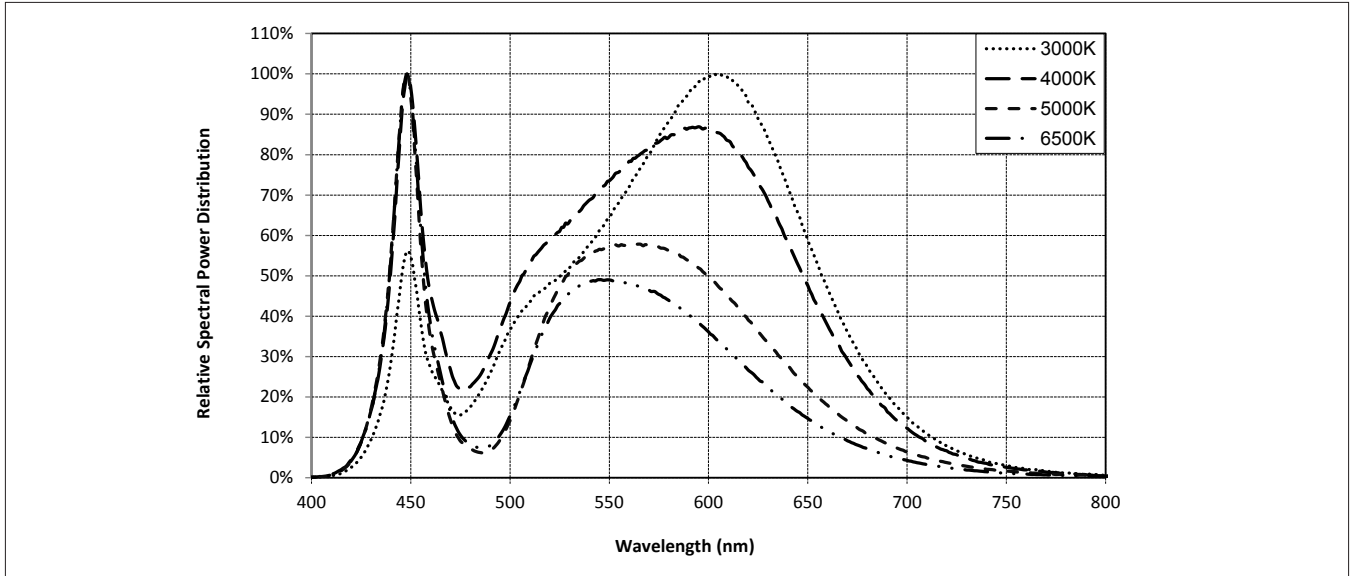

Note for Figure 19:

1. Color spectra measured at nominal current for  $T_j = T_c = 25^\circ\text{C}$ .
2. Color spectra shown is 3000K and 80 CRI.
3. Color spectra shown is 4000K and 80 CRI.
4. Color spectra shown is 5000K and 70 CRI.
4. Color spectra shown is 6500K and 70 CRI.

Figure 20: Typical Color Spectrum for Vero 10 with Décor Series

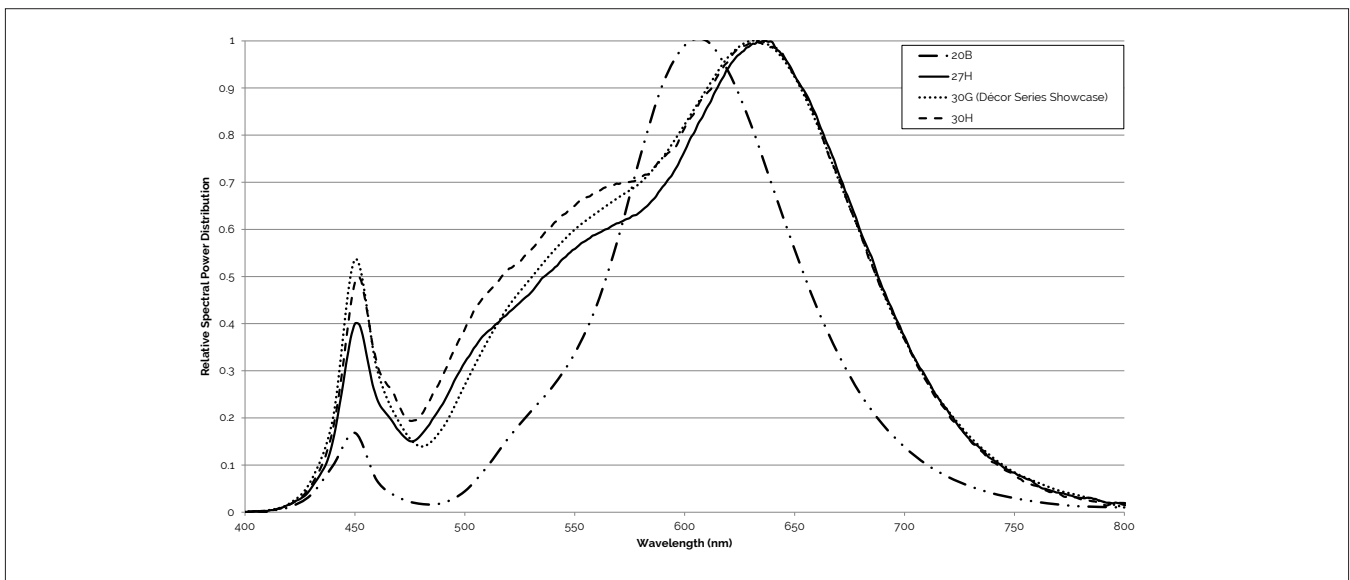

Note for Figure 20:

1. Color spectra measured at nominal current for  $T_j = T_c = 25^\circ\text{C}$ .

# Mechanical Dimensions

Figure 21: Drawing for Vero 10 LED Array

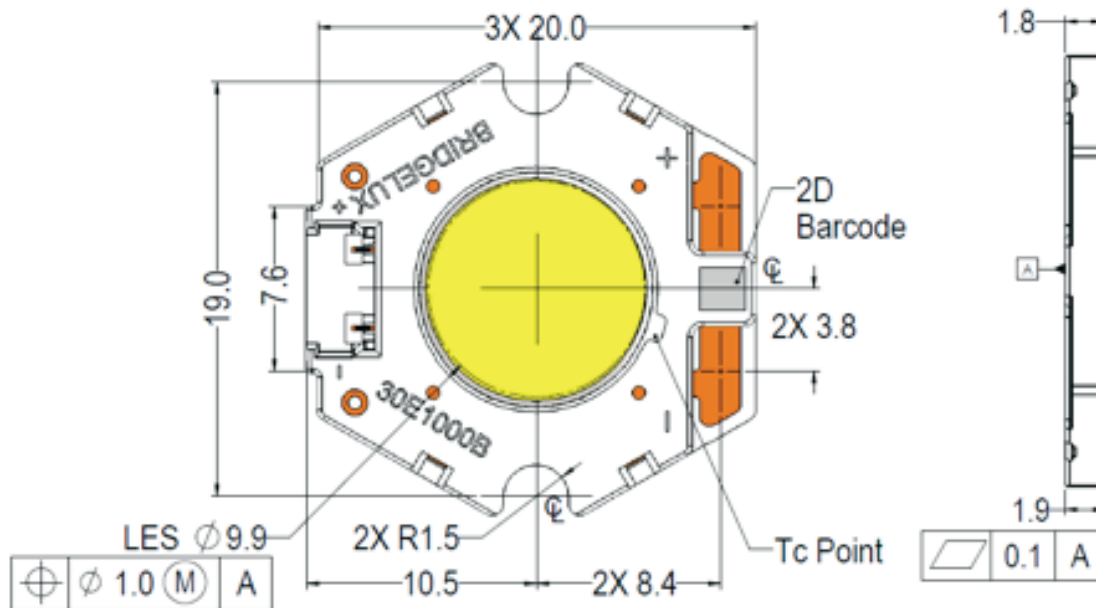

Notes for Figure 21:

1. Drawings are not to scale.
2. Dimensions are in mm.
3. Unless otherwise specified, tolerances are  $\pm 0.10\text{mm}$ .
4. Mounting slots (2X) are for M2.5 screws.
5. Bridgelux recommends two tapped holes for mounting screws with  $19.0 \pm 0.10\text{mm}$  center-to-center spacing.
6. Screws with flat shoulders (pan, dome, button, round, truss, mushroom) provide optimal torque control. Do NOT use flat, countersink, or raised head screws.
7. Solder pads and connector port are labeled "+" and "-" to denote positive and negative, respectively.
8. It is not necessary to provide electrical connections to both the solder pads and the connector port. Either set may be used depending on application specific design requirements.
9. Refer to Application Notes AN30 and AN31 for product handling, mounting and heat sink recommendations.
10. The optical center of the LED Array is nominally defined by the mechanical center of the array to a tolerance of  $\pm 0.2\text{mm}$ .
11. Bridgelux maintains a flatness of 0.10mm across the mounting surface of the array.

# Color Binning Information

**Figure 22: Warm and Neutral White Test Bins in xy Color Space**

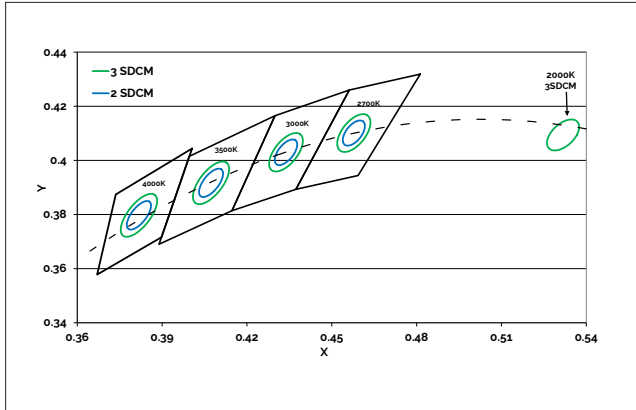

Note: Pulsed Test Conditions,  $T_c = 25^\circ\text{C}$

**Figure 23: Graph of Cool White Test Bins in xy Color Space**

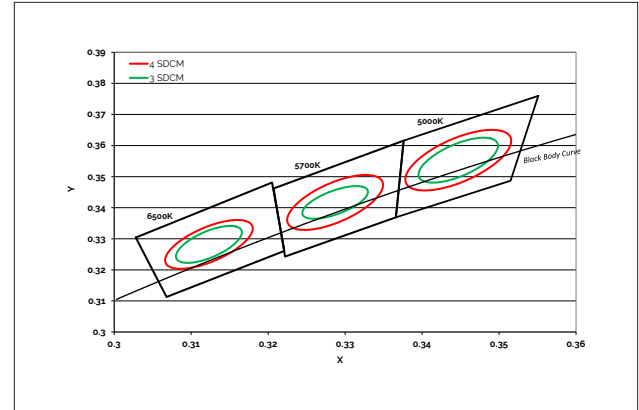

Note: Pulsed Test Conditions,  $T_c = 25^\circ\text{C}$

**Table 8: Warm and Neutral White xy Bin Coordinates and Associated Typical CCT**

Bin Code	2000K	2700K	3000K <sup>1</sup>	3500K <sup>1</sup>	4000K <sup>1</sup>
ANSI Bin (for reference only)	-	(2580K - 2870K)	(2870K - 3220K)	(3220K - 3710K)	(3710K - 4260K)
73 (3 SDCM)	-	(2651K - 2794K)	(2968K - 3136K)	(3369K - 3586K)	(3851K - 4130K)
72 (2 SDCM)	-	(2674K - 2769K)	(2995K - 3107K)	(3404K - 3548K)	(3895K - 4081K)
Center Point (x,y)	(0.5280, 0.4100)	(0.4578, 0.4101)	(0.4338, 0.403) (0.4465, 0.4024) <sup>2</sup>	(0.4073, 0.3917)	(0.3818, 0.3797)

Note for Table 8:

1. Color Binning information excludes Decor Series Class A products. Please contact your Bridgelux Sales Representative for more information.
2. Center Point for Decor Series Showcase.

**Table 9: Cool White xy Bin Coordinates and Associated Typical CCT (product is hot targeted to  $T_c = 85^\circ\text{C}$ )**

Bin Code	5000K	5700K	6500K
ANSI Bin (for reference only)	(4745K - 5311K)	(5312K - 6022K)	(6022K - 7042K)
74 (4 SDCM)	(4801K - 5282K)	(5481K - 5829K)	(6270K - 6765K)
73 (3 SDCM)	(4835K - 5215K)	(5490K - 5820K)	(6250K - 6745K)
Center Point (x,y)	(0.3447, 0.3553)	(0.3287, 0.3417)	(0.3123, 0.3282)

# Packaging and Labeling

Figure 24: Drawing for Vero 10 Packaging Tray

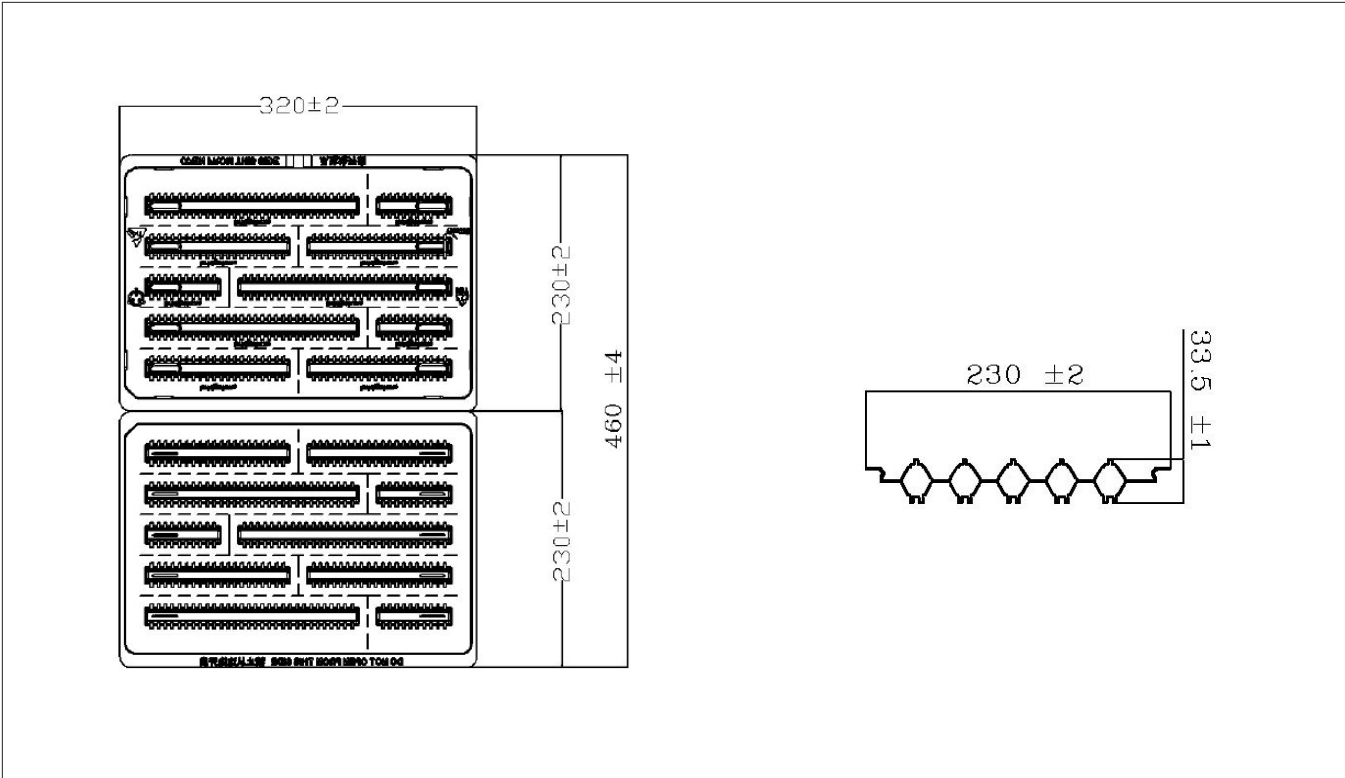

- Notes for Figure 24:
1. Dimensions are in millimeters.
  2. Drawings are not to scale.

# Packaging and Labeling

**Figure 25: Vero Series Packaging and Labeling**

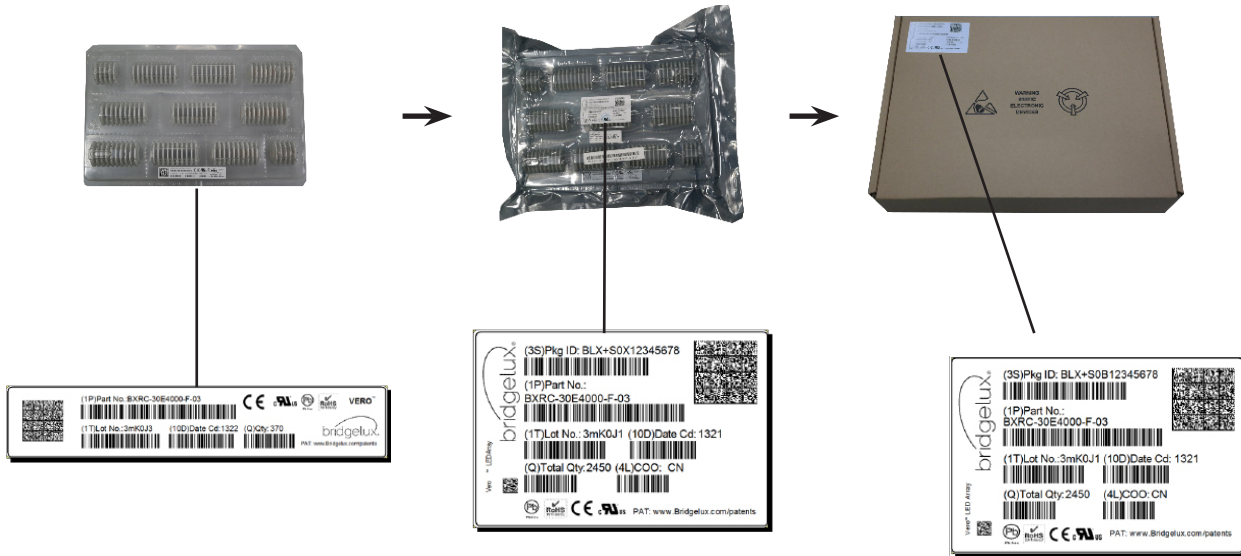

Notes for Figure 25:

1. Each tray holds 200 COBs.
2. Each tray is vacuum sealed in an anti-static bag and placed in its own box.
3. Each tray, bag and box is to be labeled as shown above.

**Figure 26: Gen. 7 Product Labeling**

Bridgelux COB arrays have laser markings on the back side of the substrate to help with product identification. In addition to the product identification markings, Bridgelux COB arrays also contain markings for internal Bridgelux manufacturing use only. The image below shows which markings are for customer use and which ones are for Bridgelux internal use only. The Bridgelux internal manufacturing markings are subject to change without notice, however these will not impact the form, function or performance of the COB array.



Customer Use- 2D Barcode  
Scannable barcode provides product part number and other Bridgelux internal production information.

Customer Use- Product part number

**30E1000C 73 2F**

Customer Use- V<sub>f</sub> Bin Code included to enable greater luminaire design flexibility. Refer to ANG2 for bin code definitions.

# Design Resources

## Application Notes

Bridgelux has developed a comprehensive set of application notes and design resources to assist customers in successfully designing with the Vero product family of LED array products. For all available application notes visit [www.bridgelux.com](http://www.bridgelux.com).

## Optical Source Models

Optical source models and ray set files are available for all Bridgelux products. For a list of available formats, visit [www.bridgelux.com](http://www.bridgelux.com).

## 3D CAD Models

Three dimensional CAD models depicting the product outline of all Bridgelux Vero LED arrays are available in both IGS and STEP formats. Please contact your Bridgelux sales representative for assistance.

## LM80

LM80 testing has been completed and the LM80 report is now available. Please contact your Bridgelux sales representative for LM-80 report.

# Precautions

## CAUTION: CHEMICAL EXPOSURE HAZARD

Exposure to some chemicals commonly used in luminaire manufacturing and assembly can cause damage to the LED array. Please consult Bridgelux Application Note AN31 for additional information.

## CAUTION: RISK OF BURN

Do not touch the Vero LED array during operation. Allow the array to cool for a sufficient period of time before handling. The Vero LED array may reach elevated temperatures such that could burn skin when touched.

## CAUTION

### CONTACT WITH LIGHT EMITTING SURFACE (LES)

Avoid any contact with the LES. Do not touch the LES of the LED array or apply stress to the LES (yellow phosphor resin area). Contact may cause damage to the LED array.

Optics and reflectors must not be mounted in contact with the LES (yellow phosphor resin area). Optical devices may be mounted on the top surface of the plastic housing of the Vero LED array. Use the mechanical features of the LED array housing, edges and/or mounting holes to locate and secure optical devices as needed.

# Disclaimers

## MINOR PRODUCT CHANGE POLICY

The rigorous qualification testing on products offered by Bridgelux provides performance assurance. Slight cosmetic changes that do not affect form, fit, or function may occur as Bridgelux continues product optimization.

## STANDARD TEST CONDITIONS

Unless otherwise stated, array testing is performed at the nominal drive current.

# About Bridgelux: We Build Light That Transforms

At Bridgelux, we help companies, industries and people experience the power and possibility of light. Since 2002, we've designed LED solutions that are high performing, energy efficient, cost effective and easy to integrate. Our focus is on light's impact on human behavior, delivering products that create better environments, experiences and returns—both experiential and financial. And our patented technology drives new platforms for commercial and industrial luminaires.

**For more information about the company, please visit**  
**bridgelux.com**  
**twitter.com/Bridgelux**  
**facebook.com/Bridgelux**  
**youtube.com/user/Bridgelux**  
**linkedin.com/company/bridgelux-inc-\_2**  
**WeChat ID: BridgeluxInChina**



46430 Fremont Boulevard  
Fremont, CA 94538  
Tel (925) 583-8400  
[www.bridgelux.com](http://www.bridgelux.com)

© 2016-2017 Bridgelux, Inc. All rights reserved 2016. Product specifications are subject to change without notice. Bridgelux, the Bridgelux stylized logo design and Vero are registered trademarks, and Decor Series is a trademark of Bridgelux, Inc. All other trademarks are the property of their respective owners.

**Bridgelux Gen 7 Vero 10 Array Series Product Data Sheet DS90 Rev. J (6/2017)**