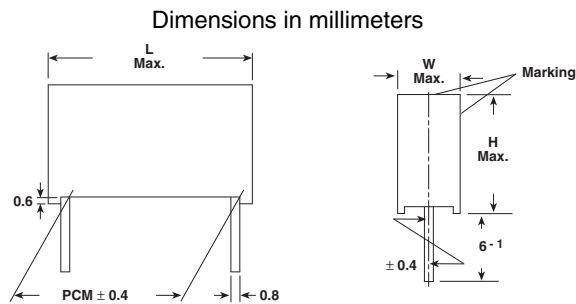

Metallized Polyester Film Capacitor

Related Document: IEC 60384-2

MAIN APPLICATIONS

Blocking, bypassing, filtering, timing, coupling and decoupling circuits, interference suppression in low voltage applications.

MARKING

Manufacturer's logo/type/C-value/rated voltage/tolerance/date of manufacture

DIELECTRIC

Polyester film

ELECTRODES

Vacuum deposited aluminum

COATING

Flame retardant plastic case (UL-class 94 V-0), green, epoxy resin sealed Flame class B according to IEC 60065 available on request

CONSTRUCTION

Extended metallized film (refer to general information)

LEADS

Tinned wire

IEC TEST CLASSIFICATION

55/100/56, according to IEC 60068

TEMPERATURE RANGE

- 55°C to + 100°C

CAPACITANCE RANGE

1000pF to 15μF

CAPACITANCE TOLERANCES

± 20% (M), ± 10% (K), ± 5% (J)

MAXIMUM PULSE RISE TIME

PCM (mm)	Maximum Pulse Rise Time d_v/d_t [V/μs]					
	63 VDC	100 VDC	250 VDC	400 VDC	630 VDC	1000 VDC
10	11	13	22	37	60	130
15	7	8	13	21	33	65
22.5	4	5	8	13	19	34
27.5	3	4	6	10	14	25

If the maximum pulse voltage is less than the rated voltage higher d_v/d_t values can be permitted.

DISSIPATION FACTOR $\tan \delta$

MEASURED AT	$C \leq 0.1\mu\text{F}$	$0.1\mu\text{F} < C \leq 1.0\mu\text{F}$	$C > 1.0\mu\text{F}$
1kHz	8×10^{-3}	8×10^{-3}	10×10^{-3}
10kHz	15×10^{-3}	15×10^{-3}	—
100kHz	25×10^{-3}	—	—
Maximum values			

FEATURES

Product is completely lead (Pb)-free
Product is RoHS compliant

RATED VOLTAGES (U_R)

63 VDC, 100 VDC, 250 VDC, 400 VDC, 630 VDC, 1000 VDC

PERMISSIBLE AC VOLTAGES (RMS) UPTO 60Hz

40 VAC, 63 VAC, 160 VAC, 200 VAC, 220 VAC, 220 VAC

TEST VOLTAGE (ELECTRODE/ELECTRODE)

$1.6 \times U_R$ for 2 s

INSULATION RESISTANCE

Measured at 100 VDC (63 VDC series measured at 50 VDC) after one minute

For $C \leq 0.33\mu\text{F}$ and $U_R > 100$ VDC:

30,000 MΩ minimum value (100,000 MΩ typical value)

For $C \leq 0.33\mu\text{F}$ and $U_R \leq 100$ VDC:

15,000 MΩ minimum value (50,000 MΩ typical value)

TIME CONSTANT

Measured at 100 VDC (63 VDC series measured at 50 VDC) after one minute

For $C > 0.33\mu\text{F}$ and $U_R > 100$ VDC:

10,000 s minimum value (40,000 s typical value)

For $C > 0.33\mu\text{F}$ and $U_R \leq 100$ VDC:

5000 s minimum value (15,000 s typical value)

CAPACITANCE DRIFT

Up to + 40°C, ± 1.5% for a period of two years

DERATING FOR DC AND AC. CATEGORY VOLTAGE U_C

At + 85°C: $U_C = 1.0 U_R$

At + 100°C: $U_C = 0.8 U_R$

SELF INDUCTANCE

~ 6 nH measured with 2mm long leads

PULL TEST ON LEADS

≥ 30 N in direction of leads according to IEC 60068-2-21

RELIABILITY

Operational life > 300,000 h

Failure rate < 2 FIT (40°C and 0.5 x UR)

For further details, please refer to the general information available at www.vishay.com/doc?26033.



RoHS
COMPLIANT

CAPACITANCE	CAPACITANCE CODE	VOLTAGE CODE 06 63 VDC/40 VAC				VOLTAGE CODE 01 100 VDC/63 VAC				VOLTAGE CODE 25 250 VDC/160 VAC			
		W	H	L	PCM	W	H	L	PCM	W	H	L	PCM
1000pF	- 210	—	—	—	—	—	—	—	—	—	—	—	—
1500pF	- 215	—	—	—	—	—	—	—	—	—	—	—	—
2200pF	- 222	—	—	—	—	—	—	—	—	—	—	—	—
3300pF	- 233	—	—	—	—	—	—	—	—	—	—	—	—
4700pF	- 247	—	—	—	—	—	—	—	—	—	—	—	—
6800pF	- 268	—	—	—	—	—	—	—	—	—	—	—	—
0.01μF	- 310	—	—	—	—	—	—	—	—	—	—	—	—
0.015μF	- 315	—	—	—	—	—	—	—	—	—	—	—	—
0.022μF	- 322	—	—	—	—	—	—	—	—	—	—	—	—
0.033μF	- 333	—	—	—	—	—	—	—	—	4.0	9.0	13.0	10
0.047μF	- 347	—	—	—	—	—	—	—	—	4.0	9.0	13.0	10
0.068μF	- 368	—	—	—	—	4.0	9.0	13.0	10	4.5	9.5	13.0	10
0.1μF	- 410	—	—	—	—	4.0	9.0	13.0	10	5.5	10.5	18.0	15
0.15μF	- 415	—	—	—	—	4.0	9.0	13.0	10	5.5	10.5	18.0	15
0.22μF	- 422	4.0	9.0	13.0	10	4.5	9.5	13.0	10	5.5	10.5	18.0	15
0.33μF	- 433	4.0	9.0	13.0	10	5.5	10.5	18.0	15	6.5	12.5	18.0	15
0.47μF	- 447	5.5	10.5	13.0	10	5.5	10.5	18.0	15	6.5	14.5	26.5	22.5
0.68μF	- 468	5.5	10.5	18.0	15	6.5	12.5	18.0	15	7.5	15.5	26.5	22.5
1.0μF	- 510	5.5	10.5	18.0	15	7.5	13.5	18.0	15	8.5	16.5	26.5	22.5
1.5μF	- 515	6.5	12.5	18.0	15	7.5	15.5	26.5	22.5	9.0	18.5	31.5	27.5
2.2μF	- 522	7.5	13.5	18.0	15	8.5	16.5	26.5	22.5	11.5	20.5	31.5	27.5
3.3μF	- 533	7.5	15.5	26.5	22.5	10.5	18.5	26.5	22.5	13.5	23.5	31.5	27.5
4.7μF	- 547	8.5	16.5	26.5	22.5	11.5	20.5	31.5	27.5	—	—	—	—
6.8μF	- 568	10.5	18.5	26.5	22.5	13.5	23.5	31.5	27.5	—	—	—	—
10.0μF	- 610	11.5	20.5	31.5	27.5	15.0	24.5	31.5	27.5	—	—	—	—
15.0μF	- 615	13.5	23.5	31.5	27.5	16.5	29.5	31.5	27.5	—	—	—	—

RECOMMENDED PACKAGING

LETTER CODE	TYPE OF PACKAGING	HEIGHT (H) (mm)	REEL DIAMETER (mm)	ORDERING CODE EXAMPLES	PCM 10	PCM 15	PCM 22.5 - 27.5
D	AMMO	16.5	S*	MKT 1822-422-065-D	X	X	—
G	AMMO	18.5	S*	MKT 1822-422-065-G	X	X	—
F	REEL	16.5	350	MKT 1822-422-065-F	X	X	—
W	REEL	18.5	350	MKT 1822-422-065-W	X	X	—
V	REEL	18.5	500	MKT 1822-510-255-V	—	X	X
G	AMMO	18.5	L*	MKT 1822-510-255-G	—	—	X
—	BULK	—	—	MKT 1822-510-255	X	X	X

*S = box size 55 x 210 x 340mm (W x H x L)

*L = box size 60 x 360 x 510mm (W x H x L)



CAPACITANCE	CAPACITANCE CODE	VOLTAGE CODE 40 400 VDC/200 VAC				VOLTAGE CODE 63* 630 VDC/220 VAC				VOLTAGE CODE 10* 1000 VDC/220 VAC			
		W	H	L	PCM	W	H	L	PCM	W	H	L	PCM
1000pF	- 210	4.0	9.0	13.0	10	4.0	9.0	13.0	10	4.0	9.0	13.0	10
1500pF	- 215	4.0	9.0	13.0	10	4.0	9.0	13.0	10	4.0	9.0	13.0	10
2200pF	- 222	4.0	9.0	13.0	10	4.0	9.0	13.0	10	4.0	9.0	13.0	10
3300pF	- 233	4.0	9.0	13.0	10	4.0	9.0	13.0	10	4.0	9.0	13.0	10
4700pF	- 247	4.0	9.0	13.0	10	4.0	9.0	13.0	10	5.5	10.5	13.0	10
6800pF	- 268	4.0	9.0	13.0	10	4.0	9.0	13.0	10	6.5	11.5	13.0	10
0.01µF	- 310	4.0	9.0	13.0	10	4.0	9.0	13.0	10	5.5	10.5	18.0	15
0.015µF	- 315	4.0	9.0	13.0	10	5.5	10.5	13.0	10	6.5	12.5	18.0	15
0.022µF	- 322	4.0	9.0	13.0	10	6.5	11.5	13.0	10	7.5	13.5	18.0	15
0.033µF	- 333	4.0	9.0	13.0	10	5.5	10.5	18.0	15	6.5	14.5	26.5	22.5
0.047µF	- 347	5.5	10.5	18.0	15	6.5	12.5	18.0	15	7.5	15.5	26.5	22.5
0.068µF	- 368	5.5	10.5	18.0	15	7.5	13.5	18.0	15	8.5	16.5	26.5	22.5
0.1µF	- 410	5.5	10.5	18.0	15	6.5	14.5	26.5	22.5	10.5	18.5	26.5	22.5
0.15µF	- 415	6.5	12.5	18.0	15	7.5	15.5	26.5	22.5	11.5	20.5	31.5	27.5
0.22µF	- 422	7.5	15.5	26.5	22.5	8.5	16.5	26.5	22.5	13.5	23.5	31.5	27.5
0.33µF	- 433	8.5	16.5	26.5	22.5	11.5	20.5	31.5	27.5	16.5	29.5	31.5	27.5
0.47µF	- 447	10.5	18.5	26.5	22.5	11.5	20.5	31.5	27.5	20.0	35.0	31.5	27.5
0.68µF	- 468	11.5	20.5	31.5	27.5	13.5	23.5	31.5	27.5	—	—	—	—
1.0µF	- 510	11.5	20.5	31.5	27.5	15.0	24.5	31.5	27.5	—	—	—	—
1.5µF	- 515	13.5	23.5	31.5	27.5	—	—	—	—	—	—	—	—
2.2µF	- 522	—	—	—	—	—	—	—	—	—	—	—	—
3.3µF	- 533	—	—	—	—	—	—	—	—	—	—	—	—
4.7µF	- 547	—	—	—	—	—	—	—	—	—	—	—	—
6.8µF	- 568	—	—	—	—	—	—	—	—	—	—	—	—
10.0µF	- 610	—	—	—	—	—	—	—	—	—	—	—	—
15.0µF	- 615	—	—	—	—	—	—	—	—	—	—	—	—

Further C-values upon request.

*Not suitable for mains applications.

Please refer to X-capacitors in our catalog "RFI Suppression Components".

RECOMMENDED PACKAGING

LETTER CODE	TYPE OF PACKAGING	HEIGHT (H) (mm)	REEL DIAMETER (mm)	ORDERING CODE EXAMPLES	PCM 10	PCM 15	PCM 22.5 - 27.5
D	AMMO	16.5	S*	MKT 1822-422-065-D	X	X	—
G	AMMO	18.5	S*	MKT 1822-422-065-G	X	X	—
F	REEL	16.5	350	MKT 1822-422-065-F	X	X	—
W	REEL	18.5	350	MKT 1822-422-065-W	X	X	—
V	REEL	18.5	500	MKT 1822-510-255-V	—	X	X
G	AMMO	18.5	L*	MKT 1822-510-255-G	—	—	X
—	BULK	—	—	MKT 1822-522-255	X	X	X

*S = box size 55 x 210 x 340mm (W x H x L)

*L = box size 60 x 360 x 510mm (W x H x L)

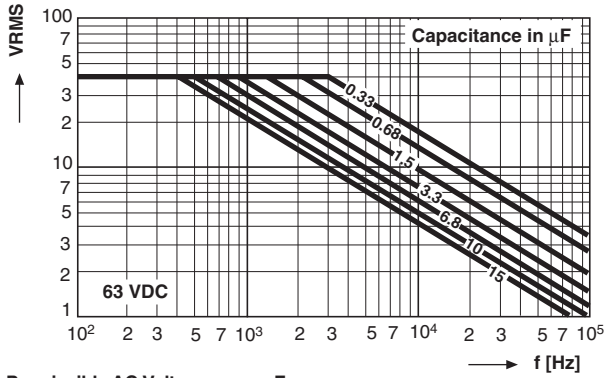

Permissible AC Voltage versus Frequency

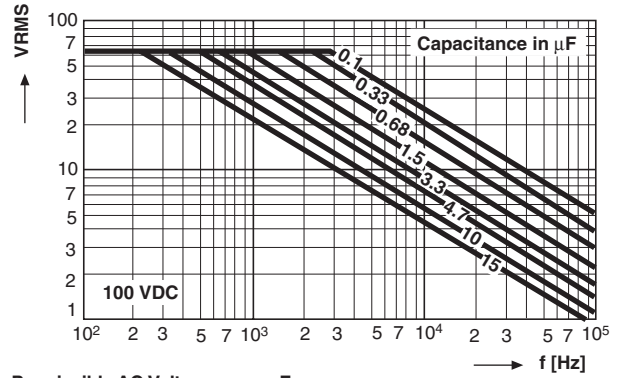

Permissible AC Voltage versus Frequency

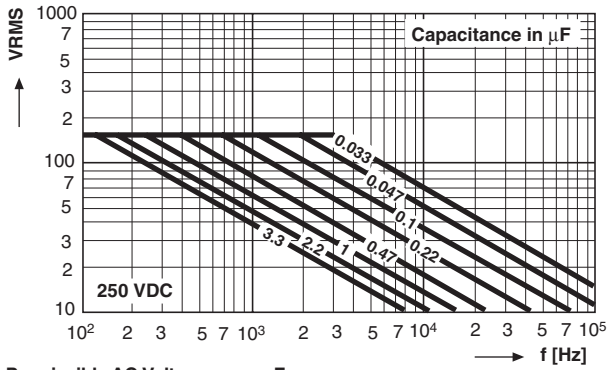

Permissible AC Voltage versus Frequency

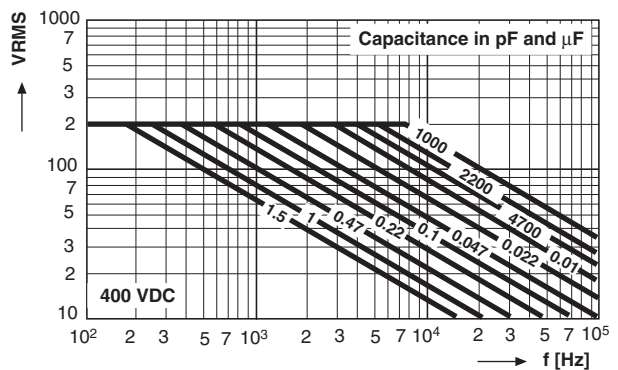

Permissible AC Voltage versus Frequency

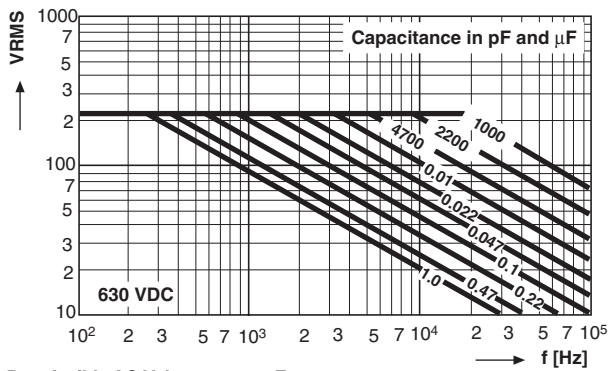

Permissible AC Voltage versus Frequency

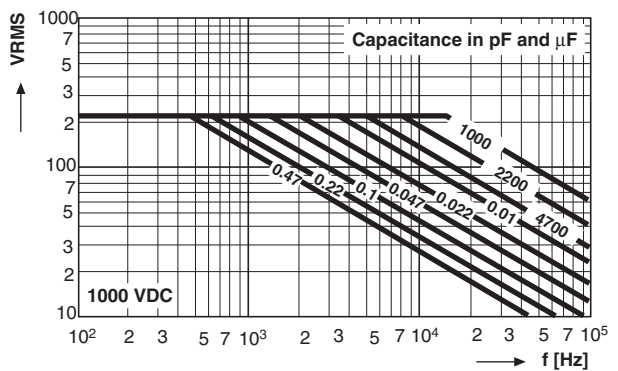

Permissible AC Voltage versus Frequency