



(<https://www.dfrobot.com/product-2371.html>)

Introduction

Look for more hardware to play with your new micro:bit? Check this out! This is a micro:bit V2-based multi-functional expansion board for programming education.

Featuring a small size of 57×87mm and a compact layout, the board expands more than 10 functional modules including sensors of all kinds, 4-way motor, LED lights, OLED screen and external power supply, which allows students to not only learn the basic functions of micro:bit but also further advance to the next level like controlling robot cars, Mecanum wheel robot, and so on. Moreover, even with so many things integrated on the board, the price still remains low. Come and explore all these extra features!

Specification

- Operating Voltage: 5V(USB)

• Operating Voltage: 5V (USB)

- External Power Supply: 6V~12V (The switch only controls the external power)
- Relay Module (P9) ×1 (On-board status indicator)
- Infrared Receiver (P13) ×1
- W2812RGB Light (P15) ×2 (RGB0 RGB1)
- Infrared Flame Sensor (I2C) ×1
- Temperature & Humidity Sensor (I2C) ×1
- Rotation Angle Sensor (I2C) ×1
- Red/Yellow/Green Traffic Light Module (I2C) ×1
- 12864_OLED Display (I2C) ×1 (With black metal protective cover)
- Motor Drive (I2C)×4 (Onboard forward/backward rotation two-color indicator)
- GPIO(5V): P0 P1 P2 P8 (External power with stronger driving capability)
- GPIO(3.3V): P0 P1 P2 P8 P12 P14 P16 (Inner power of micro:bit main-board)
- I2C Expansion Port (3.3V) ×2
- HuskyLens Port (5V I2C) ×1 (External power with stronger drive capability)
- SR04 Ultrasonic Sensor Port ×1 (5V P0 P1 GND)
- URM10 Ultrasonic Sensor Port ×1 (5V P0 P1 GND)
- Dimensions: 57×87 mm/2.24×3.43"

Board Overview

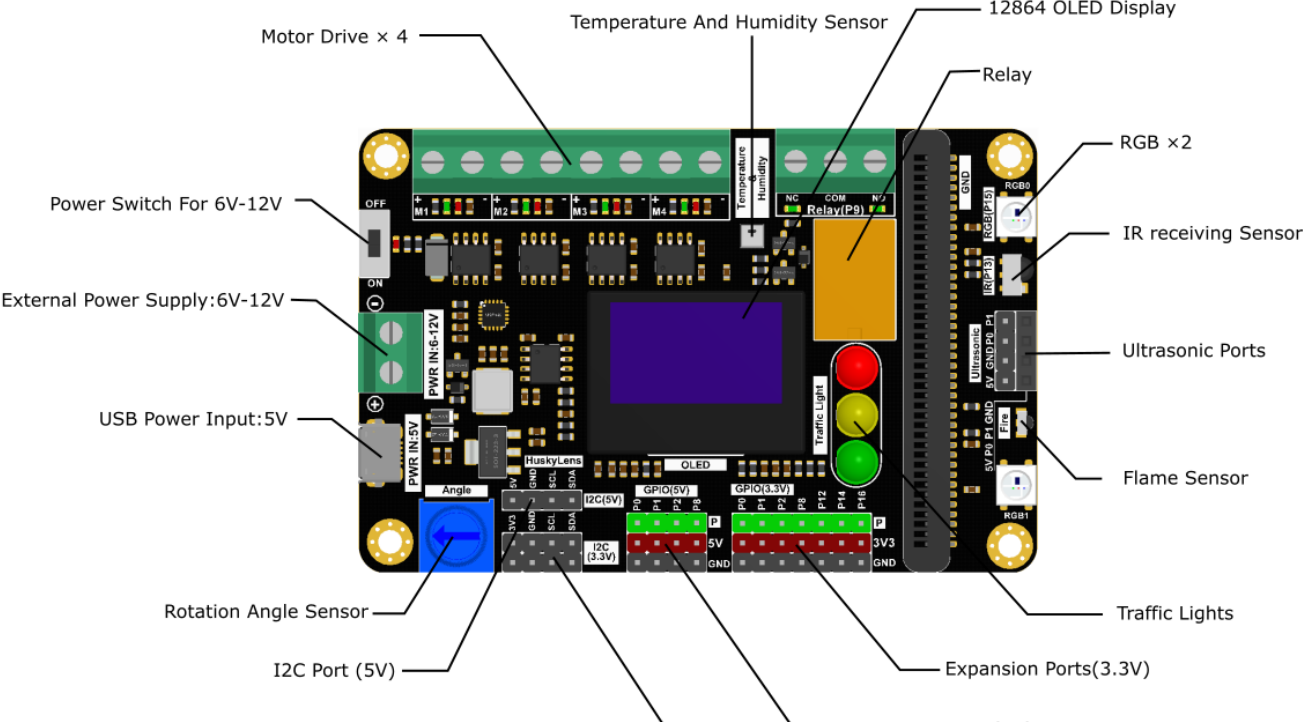

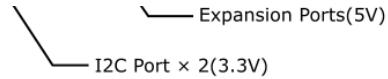

Power Supply Method

- USB power supply: The power supply of the USB interface is 5V. It can be powered by the USB interface of PC or the charger of phone, and at this time, the on-boarded switch doesn't work. This method mainly facilitates class teaching. However, the current supplied by the USB interface is limited, it is hard to drive multiple motors or servos.
- External power supply: Next to the USB interface, here is an external power supply interface, which supplies voltage of 6~12V. The on-boarded switch works here. This method of power supply is mainly used to drive multiple motors and servos. It can be used to make robot car, servo robot, etc. Multiple lithium batteries are used to power. To avoid damage to the mainboard, distinguish the positive and negative poles when connecting.

IO Ports Description

- GPIO (3.3V): the IO port power of 3.3V is led out from the micro:bit mainboard, so that the driving current is low, and it is suitable for low-power sensors and actuators.
- GPIO (5V): the IO port power of 5V is directly connected to the power supply, so that the driving ability is strong, and it is suitable for high-power external devices such as servo, and some sensors that can be only powered by 5V.
- I2C (3.3V): the IO port power of 3.3V is led out from the micro:bit mainboard, so that the driving current is low, and it is suitable for low-power sensors and actuators.
- I2C (5V): the IO port power of 5V is directly connected to the power supply, so that the driving ability is strong, and it is suitable for high-power external devices such as servo, and some sensors that can be only powered by 5V.

Tutorial- MakeCode

1. Enter the MakeCode programming platform in browser: <https://makecode.microbit.org/>
(<https://makecode.microbit.org/>)
2. Create a new project and name it.

3. Click on the "New Project" button in the top right corner of the page.

3. Load in the program library or xia_mi board: click setting , and expansion in turn, then paste this link in the search box: https://github.com/DFRobot/pxt-DFRobot_xia_mi_Board (https://github.com/DFRobot/pxt-DFRobot_xia_mi_Board).

1. Light Up RGB LED

In this sample, we are going to make the RGB light present three colors in turn.

MakeCode Program Link: https://makecode.microbit.org/_FJt7rr78WMKC
(https://makecode.microbit.org/_FJt7rr78WMKC)

on start

set brightness to 100

show color 

pause (ms) 1000

show color 

pause (ms) 1000

show color 

pause (ms) 1000

clear all LEDs

forever

RGB LED 1 show color red 200 green 150 blue 50

RGB LED 2 show color 

pause (ms) 1000

RGB LED 2 show color red 170 green 30 blue 240

RGB LED 1 show color 

pause (ms) 1000

2. Traffic Signal Light

In this sample, the red one lights for 30s, the yellow one lights for 2s, and the green one lights for 30s, in a loop execution.

MakeCode Program Link: https://makecode.microbit.org/_RduW652MPKyk
(https://makecode.microbit.org/_RduW652MPKyk)

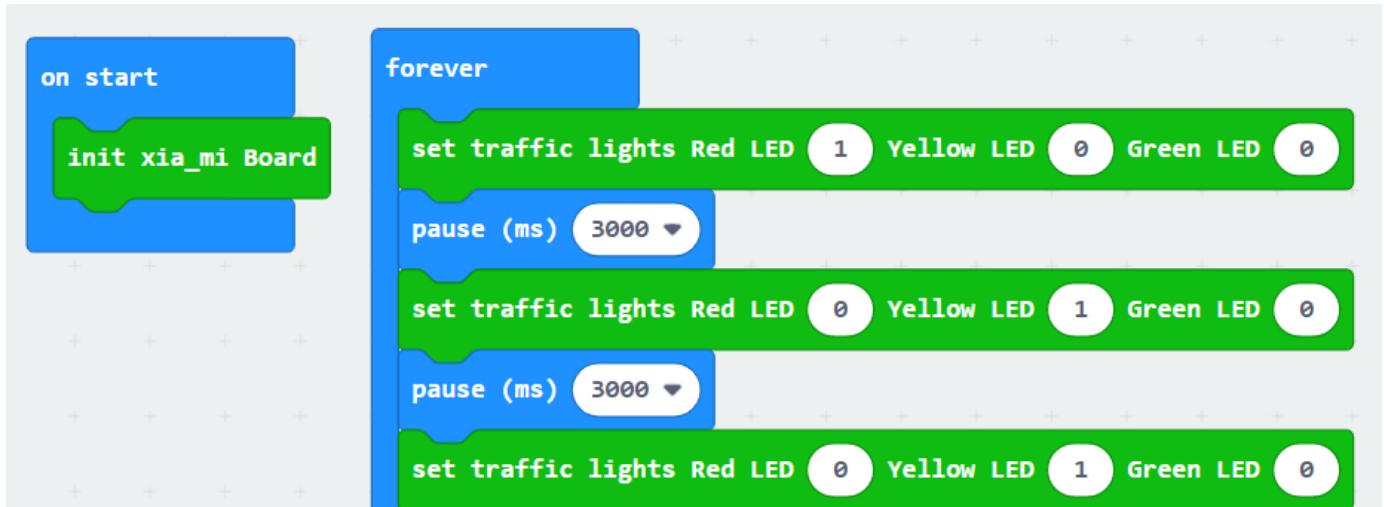

The image shows a block-based programming interface with two main sections: 'on start' and 'forever'.

- on start:** Contains a single green block labeled 'init xia_mi Board'.
- forever:** Contains a repeating loop of three states:
 - State 1:** 'set traffic lights Red LED 1 Yellow LED 0 Green LED 0' followed by a 'pause (ms) 3000' block.
 - State 2:** 'set traffic lights Red LED 0 Yellow LED 1 Green LED 0' followed by a 'pause (ms) 3000' block.
 - State 3:** 'set traffic lights Red LED 0 Yellow LED 1 Green LED 0' followed by a 'pause (ms) 3000' block.

pause (ms) 3000

3. Ambient Temperature and Humidity Sensor

In this sample, read the values of temperature and humidity, and display them on the OLED.

MakeCode Program Link: https://makecode.microbit.org/_K7y2TtVvMio7

(https://makecode.microbit.org/_K7y2TtVvMio7)

on start

init xia_mi Board

forever

OLED show text join "temperature:" read Temperature " C" on line 0 column 0

OLED show text join "humidity:" read Humidity "%" on line 1 column 0

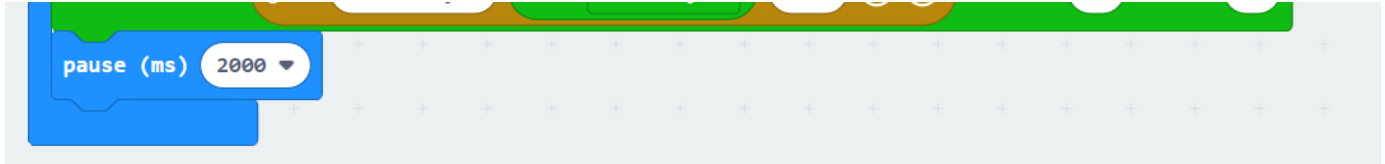

4. Control Servo via Angular Rotation Sensor

In this sample, a 9g servo is connected to the P0 port, and the rotation angle sensor is used to control the angle of the servo. The position of the knob and the angle of the servo are displayed on the screen in real time.

MakeCode Program Link: https://makecode.microbit.org/_TVmLvAXTq2v5
(https://makecode.microbit.org/_TVmLvAXTq2v5)

on start

init xia_mi Board

forever

set A ▾ to map read angle number from low 0 high 1023 to low 0 high 180

OLED show number read angle number on line 0 column 0

OLED show number A ▾ on line 1 column 0

clear OLED line 0 column 0 to 3

servo write pin P0 ▾ to A ▾

5. IR-controlled Relay Switch

In this sample, the mini-infrared remote control is used to control the relay. When the button 1 on the remote control is pressed, the relay is closed, and when the button 0 is pressed, the relay is released. The corresponding relay indicator will switch automatically.

Infrared remote control and corresponding key value:

Key	Value (In hexadecimal)	Value (In decimal)
Red Key	0xff00	0
VOL+	0xfe01	1
FUNC/STOP	0xfd02	2
Left Arrow	0xfb04	4
Pause	0xfa05	5
Right Arrow	0xf906	6
Down Arrow	0xf708	8



VOL-	0xf609	9
Up Arrow	0xf50a	10
0	0xf30c	12
EQ	0xf20d	13
ST/REPT	0xf10e	14
1	0xef10	16
2	0xee11	17
3	0xed12	18
4	0xeb14	20
5	0xea15	21
6	0xe916	22
7	0xe718	24
8	0xe619	25
9	0xe51a	26



MakeCode Program Link: https://makecode.microbit.org/_FEt27cb1qLar
 (https://makecode.microbit.org/_FEt27cb1qLar)

```
on IR received message
  if message = 16 then
    close relay
  +
  if message = 12 then
    Discon relay
  +
```

The image shows a Scratch script starting with an 'on IR received' block containing a 'message' variable. It contains two conditional 'if' blocks. The first 'if' block checks if 'message' is equal to '16'. If true, it executes a 'close relay' block. The second 'if' block checks if 'message' is equal to '12'. If true, it executes a 'Discon relay' block. There are plus signs in circles between the 'if' blocks and at the end of the script, indicating they can be added or removed.



6. Fire Alarm

In this sample, a lighter is needed, please pay attention to the safety of using fire. Turn on the lighter about 20cm in front of the flame sensor, the display will show the current flame intensity value, if it exceeds 200, the buzzer will start to alarm, and stop the alarm when it is lower than 200. Because the infrared flame sensor also has a certain sense of sunlight, it has a value of several tens by default. The stronger the light, the larger the value, which is normal. But the infrared flame sensor is more sensitive to the wavelength of the flame.

MakeCode Program Link: https://makecode.microbit.org/_HAJpPYYfW6hq
(https://makecode.microbit.org/_HAJpPYYfW6hq)

on start

init xia_mi Board

forever

OLED show number read flre sensor number on line 0 column 0

clear OLED line 0 column 2 to 2

if read flre sensor number > 200 then

ring tone (Hz) Middle D

else

stop all sounds

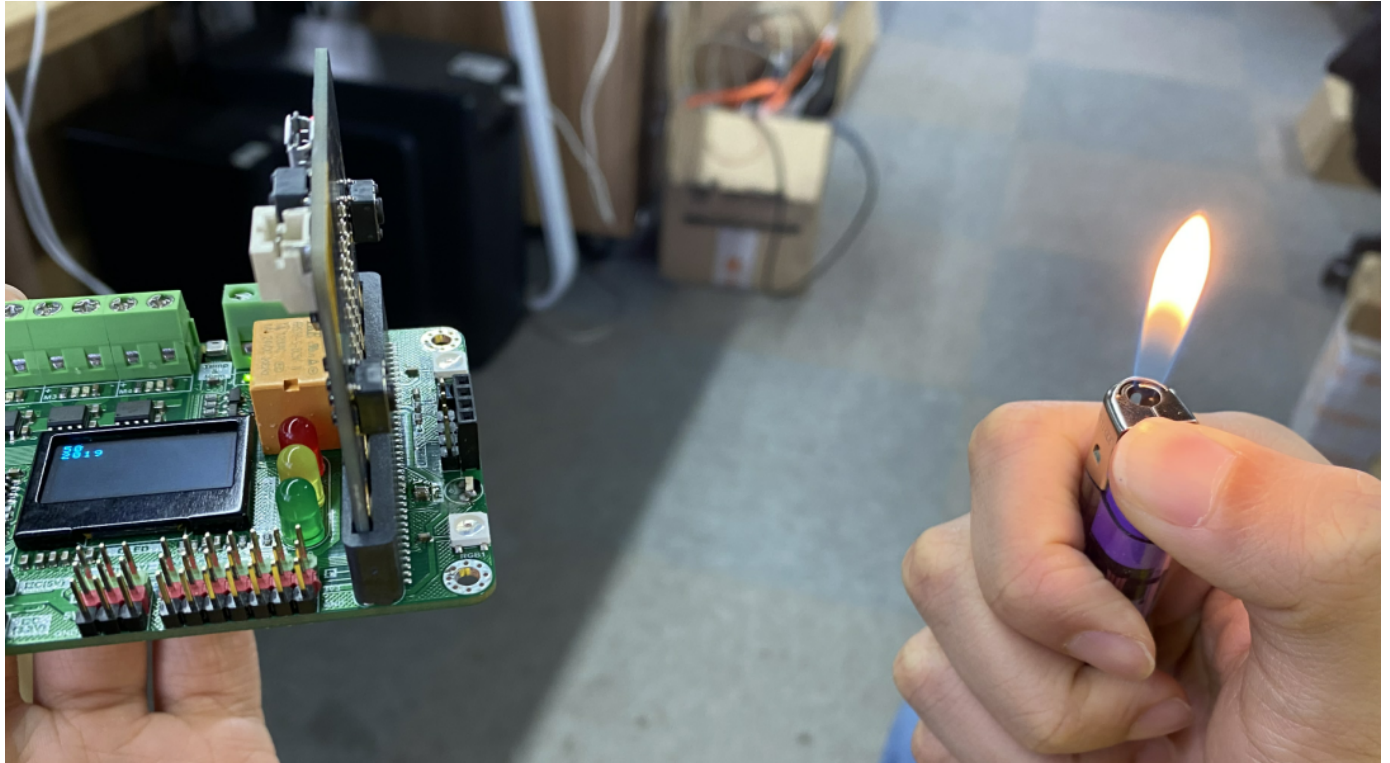

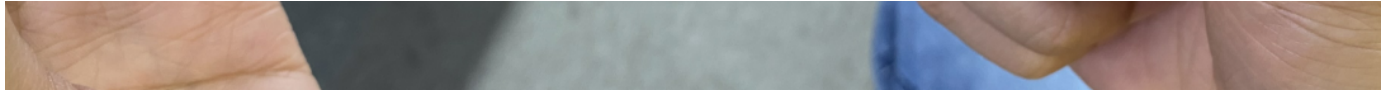

7. SR04 Ultrasonic Distance Sensor

This sample will use the SR04 ultrasonic module. This module is not included in the product and needs to be purchased independently. Insert the SR04 ultrasonic sensor into the interface (as shown in the figure below), and it will display the measured distance on the OLED screen.

MakeCode Program Link: https://makecode.microbit.org/_0K01rcdXf0y1
(https://makecode.microbit.org/_0K01rcdXf0y1)

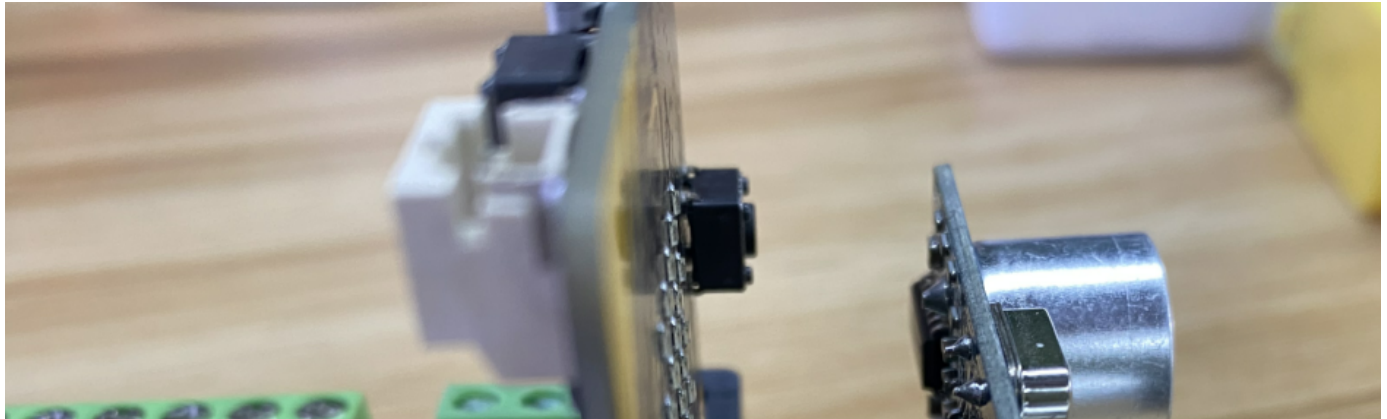

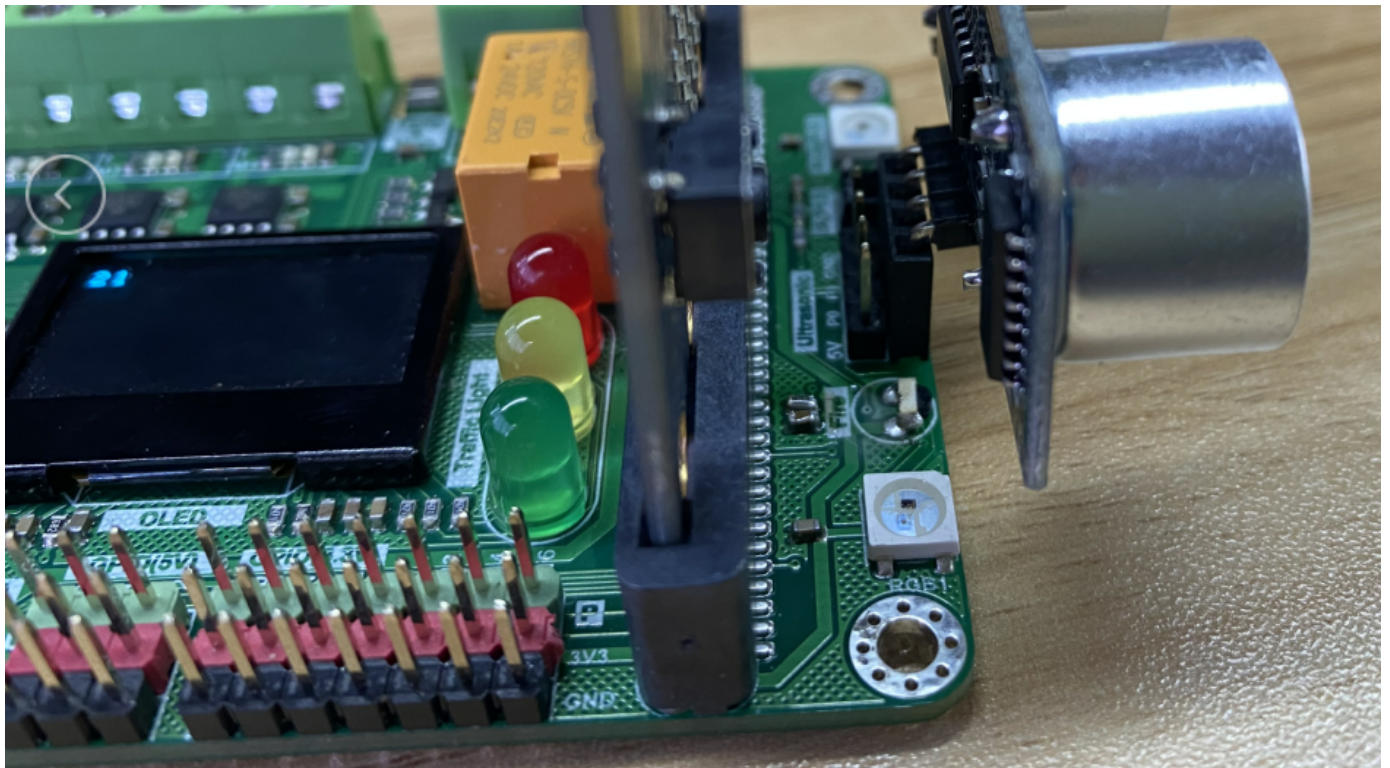

on start

init xia_mi Board

forever

OLED show number read ultrasonic sensor (cm) on line 0 column 0

clear OLED line 0 column 2 to 2

pause (ms) 100

8. 4-way Motor Drive

This product is equipped with 4 motor drives on board, which can be used as the control board of the Mecanum wheel robot platform. In this sample, 4 motors are driven to realize forward and reverse rotation. Demonstrate the use of motor drive.

MakeCode Program Link: https://makecode.microbit.org/_eR62rrYvCfyo
(https://makecode.microbit.org/_eR62rrYvCfyo)

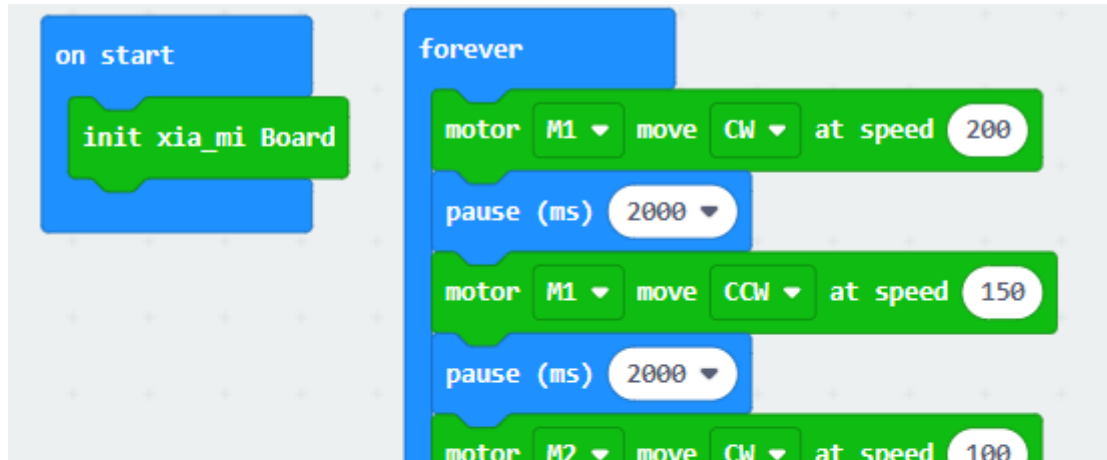

pause (ms) 2000

motor M2 move CCW at speed 150

pause (ms) 2000

motor M3 move CW at speed 255

pause (ms) 2000

motor M3 move CCW at speed 50

pause (ms) 2000

motor M4 move CW at speed 100

pause (ms) 2000

motor M4 move CCW at speed 200

pause (ms) 2000

motor ALL stop



FAQ

For any questions, advice or cool ideas to share, please visit the **DFRobot Forum** (<https://www.dfrobot.com/forum/>).

More Documents

 Get xia mi board for micro:bit (<https://www.dfrobot.com/product-2371.html>) from DFRobot Store or **DFRobot Distributor**. (<https://www.dfrobot.com/index.php?route=information/distributorslogo>)

Turn to the Top