

PTSM 0,5/ 4-2,5-V THR R44

Order No.: 1770979



PC terminal block, Nominal current: 6 A, Nom. voltage: 63 V, Pitch: 2.5 mm, Number of positions: 4, Type of connection: Spring-cage conn., Mounting: SMD/THT/THR, Conductor/PCB connection direction: 90 °, Color: black

Commercial data

EAN	4046356459556
Pack	310
Weight/Piece	2.58 g
Country of Origin	DE
Catalog page information	Page 463 (CC-2009)

Product notes

WEEE/RoHS-compliant since:
26/04/2010



Please note that the data given here has been taken from the online catalog. For comprehensive information and data, please refer to the user documentation at <http://www.download.phoenixcontact.com>. The General Terms and Conditions of Use apply to Internet downloads.

Technical data**Dimensions / positions**

Length	5 mm
Pitch	2.5 mm
Dimension a	7.5 mm
Number of positions	4

Pin dimensions	0,3 X 0,8 mm
Pin spacing	2.5 mm
Hole diameter	1.2 mm

Technical data

Range of articles	PTSM 0,5/..-V-THR
Insulating material group	IIIa
Rated surge voltage (III/3)	2.5 kV
Rated surge voltage (III/2)	2.5 kV
Rated surge voltage (II/2)	2.5 kV
Rated voltage (III/2)	200 V
Rated voltage (II/2)	200 V
Connection in acc. with standard	EN-VDE
Nominal current I_N	6 A
Nominal voltage U_N	63 V
Nominal cross section	0.5 mm ²
Maximum load current	6 A
Insulating material	LCP
Inflammability class acc. to UL 94	V0
Stripping length	6 mm
Nominal voltage, UL/CUL Use Group B	150 V
Nominal current, UL/CUL Use Group B	5 A

Connection data

Conductor cross section solid min.	0.14 mm ²
Conductor cross section solid max.	0.5 mm ²
Conductor cross section stranded min.	0.2 mm ²
Conductor cross section stranded max.	0.5 mm ²
Conductor cross section stranded, with ferrule without plastic sleeve min.	0.25 mm ²
Conductor cross section stranded, with ferrule without plastic sleeve max.	0.5 mm ²
Conductor cross section AWG/kcmil min.	24
Conductor cross section AWG/kcmil max	20
Minimum AWG according to UL/CUL	26
Maximum AWG according to UL/CUL	20

Certificates



Certification

CUL, UL

CUL

Nominal voltage U_N	150 V
Nominal current I_N	5 A
AWG/kcmil	26-20

UL

Nominal voltage U_N	150 V
Nominal current I_N	5 A
AWG/kcmil	26-20

Accessories

Item	Designation	Description
------	-------------	-------------

Tools

1205202	SZS 0,4X2,0	Micro screwdriver, bladed, size: 0.4 x 2.0 x 60 mm, 2-component grip, with non-slip grip and twist cap
---------	-------------	--

Drawings

Drilling plan/solder pad geometry

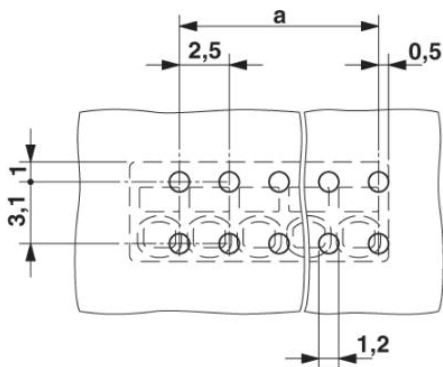

Diagram

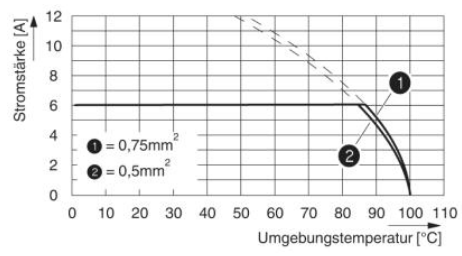

Dimensioned drawing

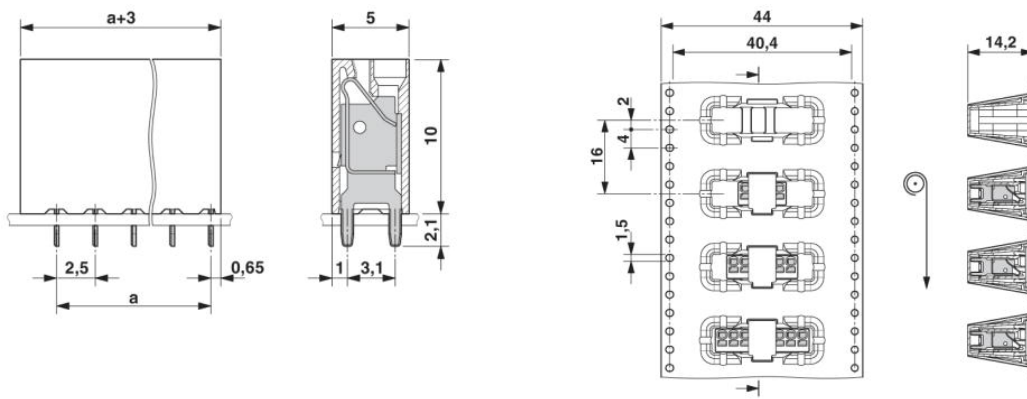

Address

PHOENIX CONTACT Ltd
Halesfield 13
Telford / Shropshire / TF7 4PG,England
Phone 01952 681 700
Fax 01952 681 799
<http://www.phoenixcontact.co.uk>



Phoenix Contact Ltd.
Technical modifications reserved;
