

●Application

- Motor drive
- Inverter, Converter
- Photovoltaics, wind power generation.
- Induction heating equipment.

●Features

- 1) Low surge, low switching loss.
- 2) High-speed switching possible.
- 3) Reduced temperature dependence.

●Circuit diagram

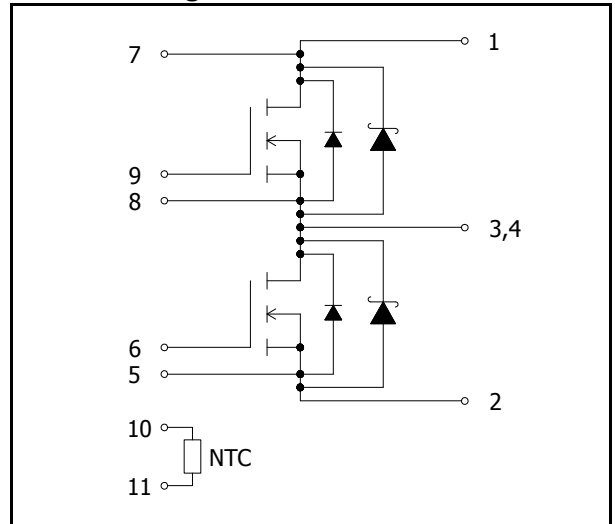

●Construction

This product is a half bridge module consisting of SiC-UMOSFET and SiC-SBD from ROHM.

●Dimensions & Pin layout (Unit : mm)

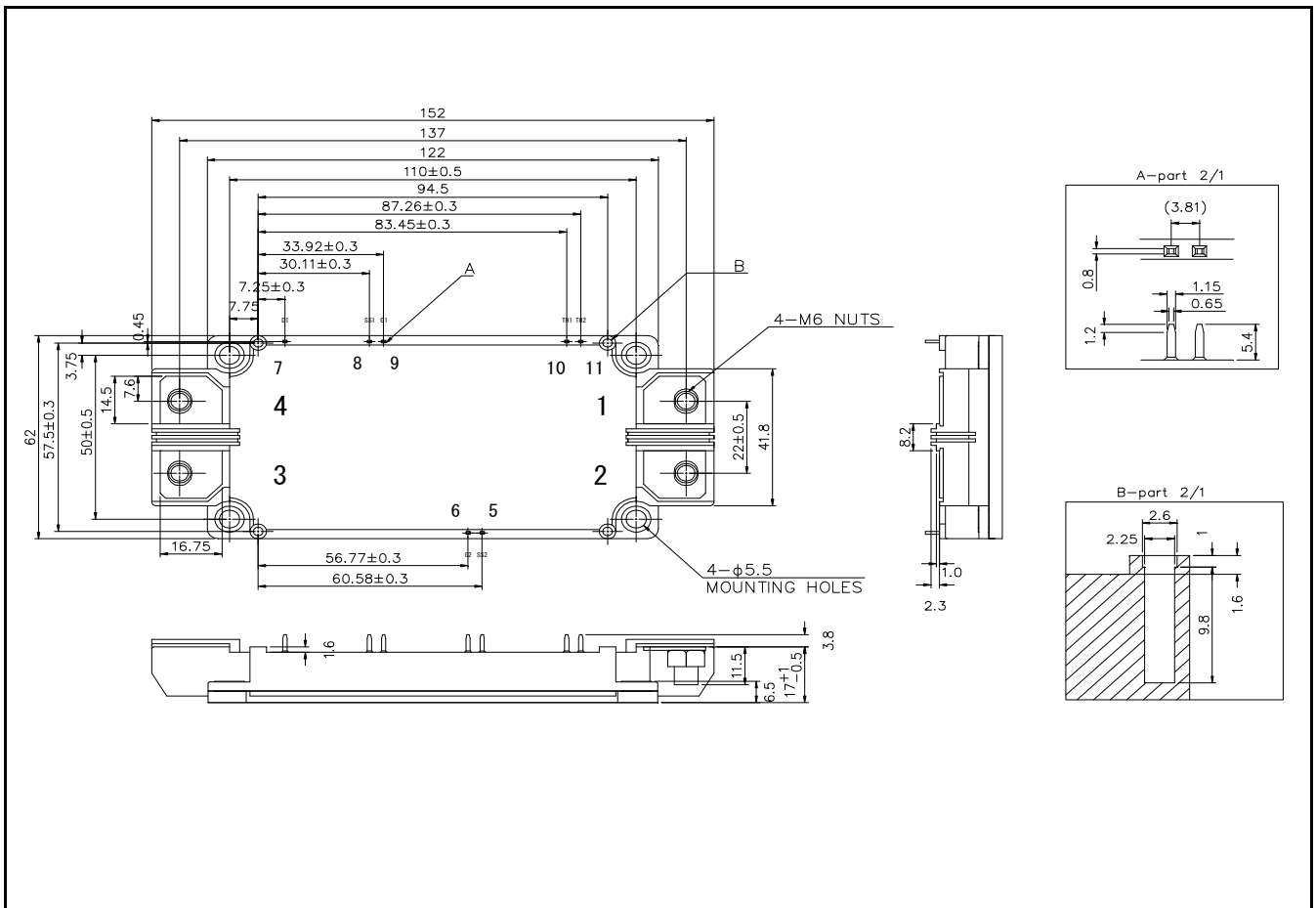

●Absolute maximum ratings (T_j = 25°C)

Parameter	Symbol	Conditions	Ratings	Unit
Drain - Source Voltage	V _{DSS}	G-S short	1200	V
Gate - Source Voltage (+)	V _{GSS}	D-S short	22	
Gate - Source Voltage (-)	V _{GSS}	D-S short	-4	
G - S Voltage (t _{surge} < 300nsec)	V _{GSSsurge}	D-S short	-4 to 26	
Drain Current <small>Note 1)</small>	I _D	DC(Tc=60°C) VGS=18V	576	A
	I _D	DC(Tc=50°C) VGS=18V	600	
	I _{DRM}	Pulse (Tc = 60°C) 1ms VGS=18V <small>Note 2)</small>	1200	
Source Current <small>Note 1)</small>	I _S	DC(Tc=60°C) VGS=18V	576	
	I _S	DC(Tc=50°C) VGS=18V	600	
	I _S	DC(Tc=60°C) VGS=0V	418	
	I _{SRM}	Pulse (Tc = 60°C) 1ms VGS=18V <small>Note 2)</small>	1200	
	I _{SRM}	Pulse (Tc = 60°C) 10us VGS=0V <small>Note 2)</small>	1200	
Total Power Dissipation <small>Note 3)</small>	P _{tot}	Tc = 25°C	2450	W
Max Junction Temperature	T _{jmax}		175	°C
Junction Temperature	T _{jop}		-40 to 150	
Storage Temperature	T _{stg}		-40 to 125	
Isolation Voltage	Visol	Terminals to baseplate f = 60Hz AC 1 min.	2500	Vrms
Mounting Torque	-	Main Terminals : M6 screw	4.5	N · m
		Mounting to heat sink M5 screw	3.5	

Note 1) Case temperature (Tc) is defined on the surface of base plate just under the chips.

Note 2) Repetition rate should be kept within the range where temperature rise if die should not exceed T_{jmax}.

Note 3) T_j is less than 175°C.

Example of acceptable V_{GS} waveform

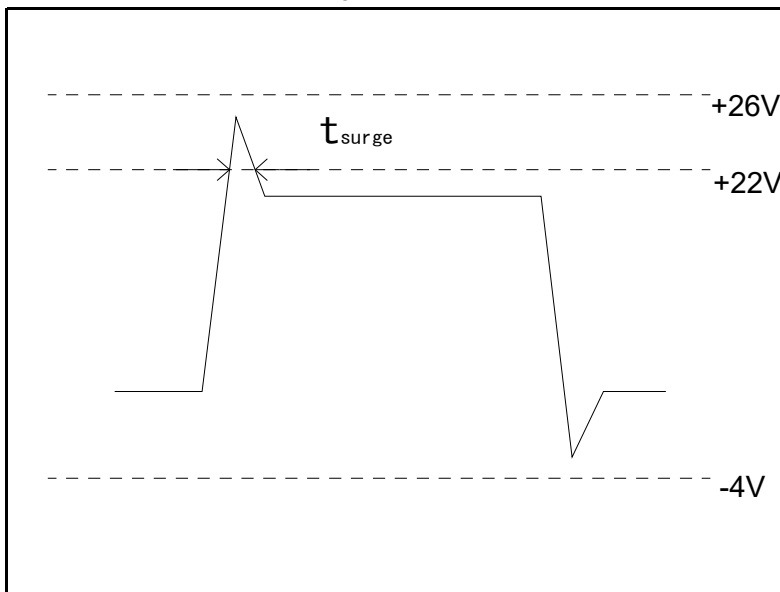

<Wavelength for Switching Test>

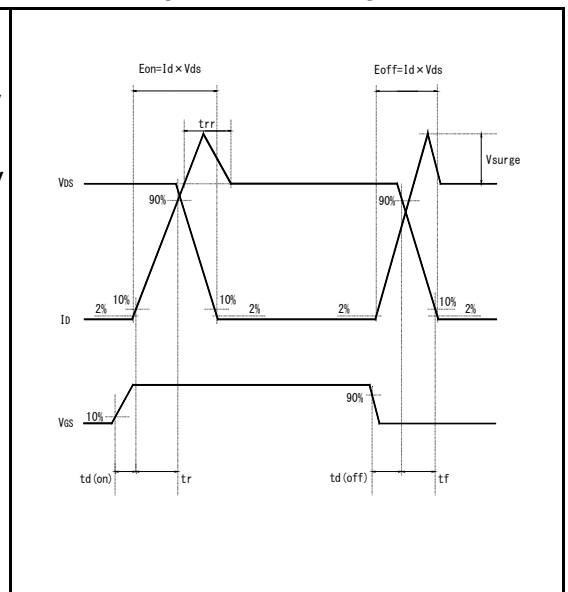

●Electrical characteristics (T_j=25°C)

Parameter	Symbol	Conditions	Ratings			Unit	
			Min.	Typ.	Max.		
On-state static Drain-Source Voltage	V _{DS(on)}	I _D =600A, V _{GS} =18V	T _j =25°C	—	1.8	2.4	V
			T _j =125°C	—	2.6	—	
			T _j =150°C	—	2.9	4.1	
Drain Cutoff Current	I _{DSS}	V _{DS} =1200V, V _{GS} =0V	—	—	4	mA	
Souce-Drain Voltage	V _{SD}	V _{GS} =0V, I _S =600A	T _j =25°C	—	2.0	2.9	V
			T _j =125°C	—	2.6	—	
			T _j =150°C	—	2.7	4.6	
		V _{GS} =18V, I _S =600A	T _j =25°C	—	1.4	—	
			T _j =125°C	—	1.7	—	
			T _j =150°C	—	1.9	—	
Gate-Source Threshold Voltage	V _{GS(th)}	V _{DS} =10V, I _D =182mA	2.7	—	5.6	V	
Gate-Source Leak Current	I _{GSS}	V _{GS} =22V, V _{DS} =0V	—	—	0.5	μA	
		V _{GS} =-6V, V _{DS} =0V	-0.5	—	—		
Switching Characteristics	td(on)	V _{GS(on)} =18V, V _{GS(off)} =-2V <small>Note 4)</small> V _{DS} =600V I _D =600A R _{G(on)} =1.8 ohm, R _{G(off)} =1.8 ohm Inductive load	—	60	—	ns	
	tr		—	70	—		
	trr		—	45	—		
	td(off)		—	320	—		
	tf		—	65	—		
Input Capacitance	C _{iss}	V _{DS} =10V, V _{GS} =0V, 200kHz	—	31	—	nF	
Gate Registance	R _{Gint}	T _j =25°C	—	1.4	—	Ω	
NTC Rated Resistance	R ₂₅		—	5.0	—	kΩ	
NTC B Value	B _{50/25}		—	3370	—	K	
Stray Inductance	L _s		—	10.0	—	nH	
Creepage Distance	-	Terminal to heat sink	—	16.7	—	mm	
		Terminal to terminal	—	16.7	—	mm	
Clearance Distance	-	Terminal to heat sink	—	12.0	—	mm	
		Terminal to terminal	—	11.0	—	mm	
Junction-to -Case Thermal Resistance	R _{th(j-c)}	UMOSFET (1/2 module) <small>Note 5)</small>	—	—	61	°C/kW	
		SBD (1/2 module) <small>Note 5)</small>	—	—	80		
Case-to -heat sink Thermal Resistance	R _{th(c-f)}	Case to heat sink, per 1 module. Thermal grease applied. <small>Note 6)</small>	—	15	—		

Note 4) In order to prevent self turn-on, it is recommended to apply negative gate bias.

Note 5) Measurement of T_c is to be done at the point just under the chip.

Note 6) Typical value is measured by using thermally conductive grease of λ=0.9W/(m·K).

Note 7) SiC devices have lower short cuicuit withstand capability due to high current density. Please be advised to pay careful attention to short cuicuit accident and try to adjust protection time to shutdown them as short as possible.

Note 8) If the Product is used beyond absolute maximum ratings defined in the Specifications, as its internal structure may be damaged, please replace such Product with a new one.

●Electrical characteristic curves (Typical)

Fig.1 Output characteristic 25°C (TYP)

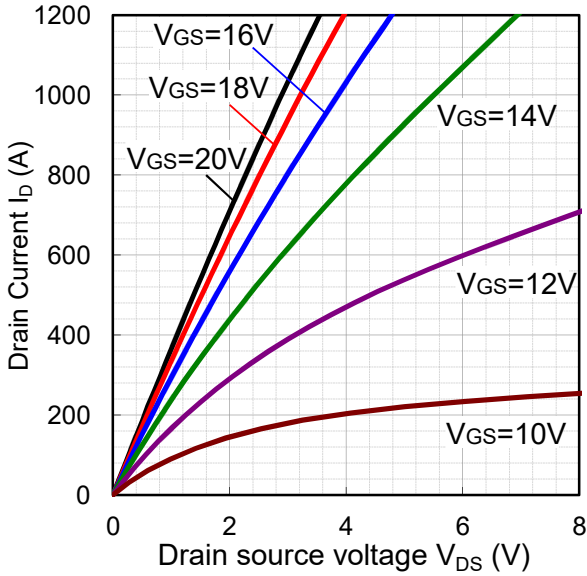

Fig.2 Drain source voltage characteristic (TYP)

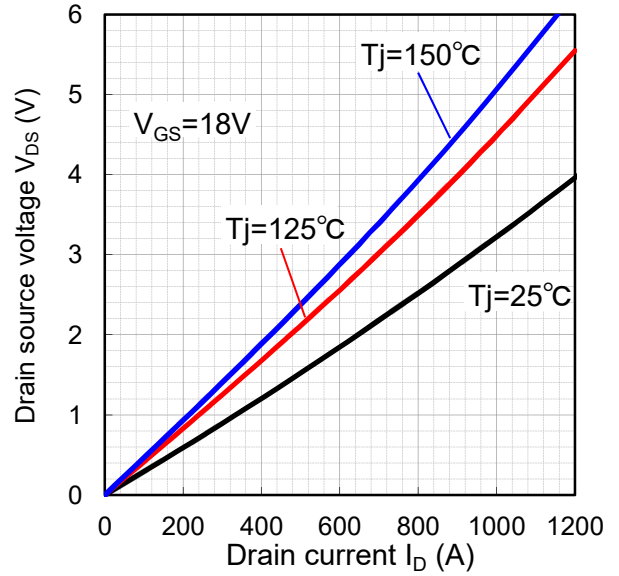

Fig.3 Drain source voltage characteristic 25°C (TYP)

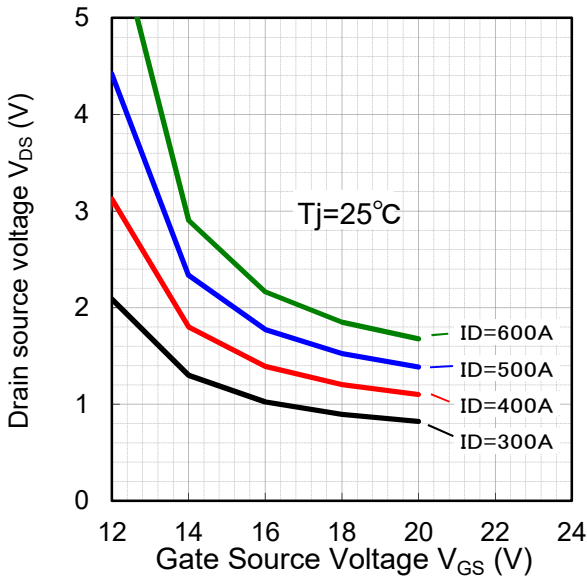
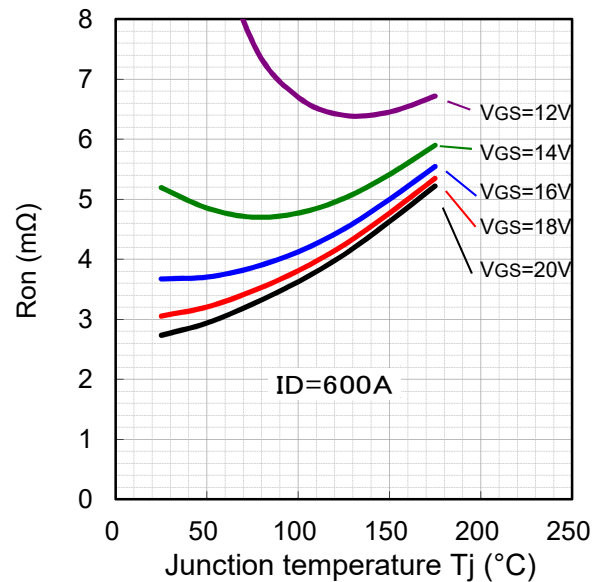

Fig.4 Ron vs Tj characteristic (TYP)



●Electrical characteristic curves (Typical)

Fig.5 Forward characteristic of Diode (TYP)

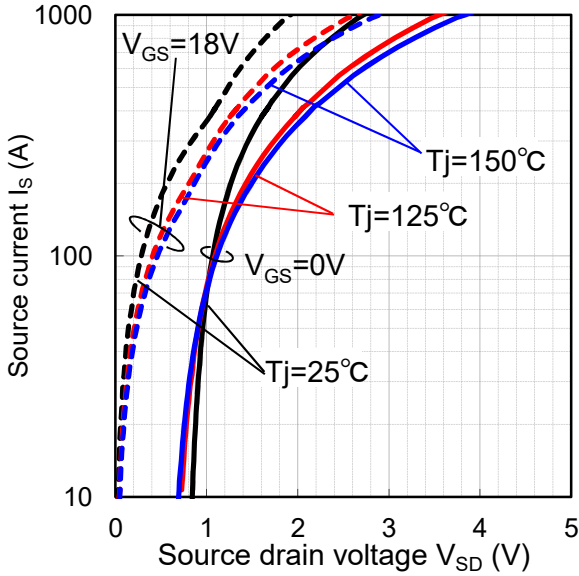

Fig.6 Forward characteristic of Diode (TYP)

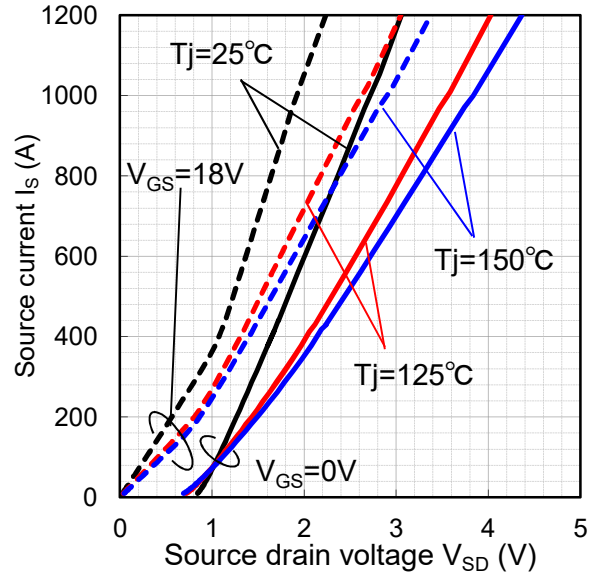

Fig.7 Drain Current vs Gate Voltage (TYP)

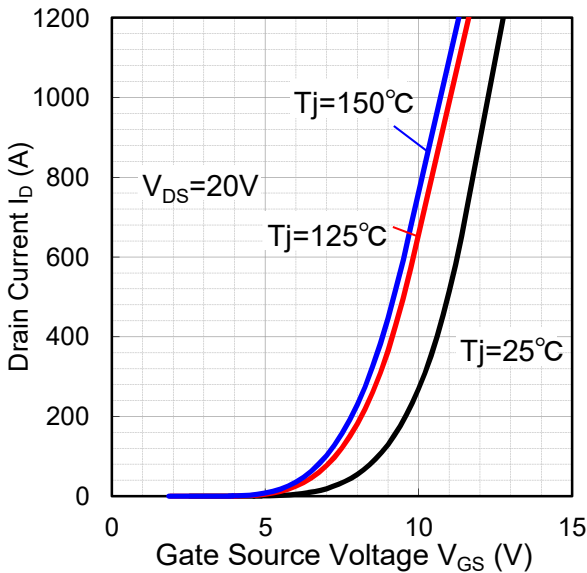
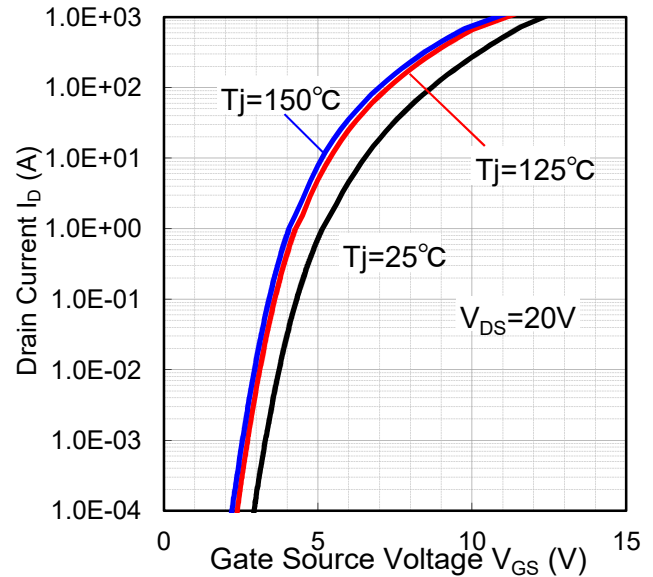

Fig.8 Drain Current vs Gate Voltage (TYP)



●Electrical characteristic curves (Typical)

Fig.9 Switching time vs drain current at 25°C (TYP)

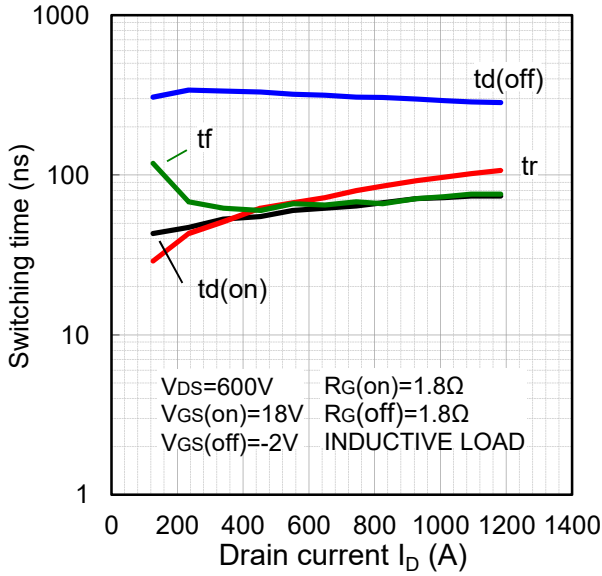

Fig.10 Switching time vs drain current at 125°C (TYP)

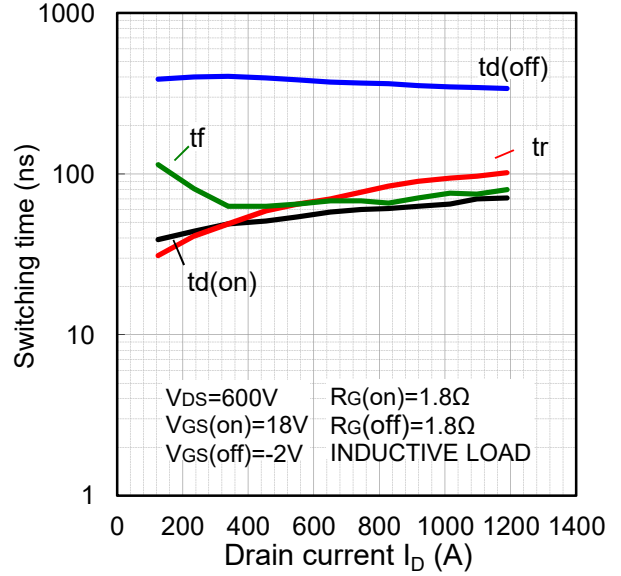

Fig.11 Switching time vs drain current at 150°C (TYP)

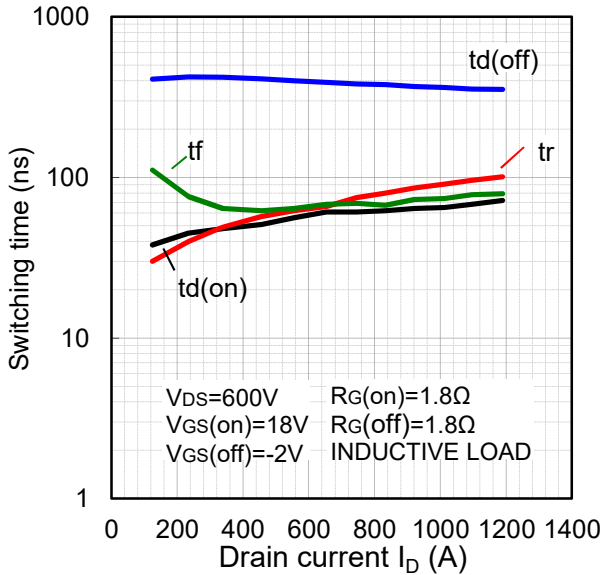
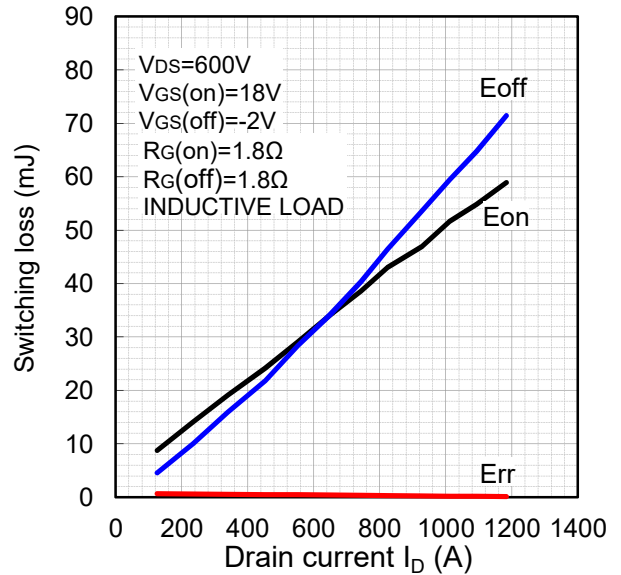

Fig.12 Switching loss vs drain current at 25°C (TYP)



●Electrical characteristic curves (Typical)

Fig.13 Switching loss vs drain current at 125°C (TYP)

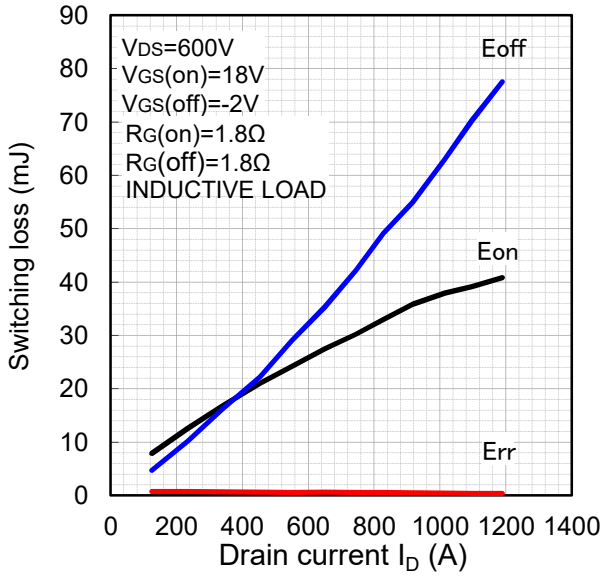

Fig.14 Switching loss vs drain current at 150°C (TYP)

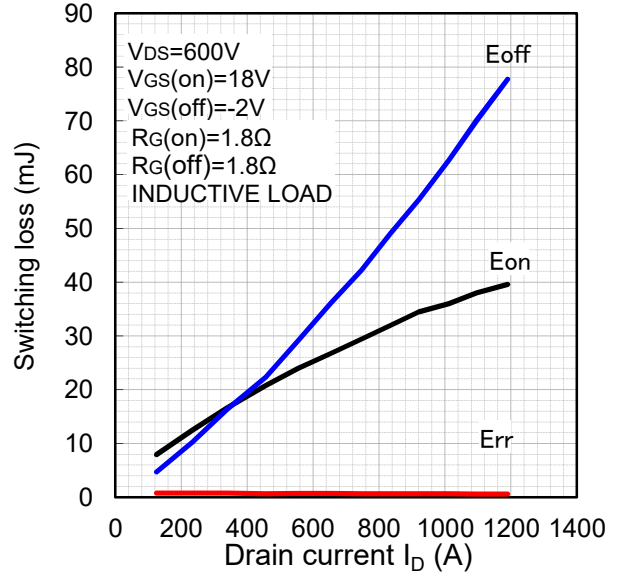

Fig.15 Recovery characteristic vs drain current at 25°C (TYP)

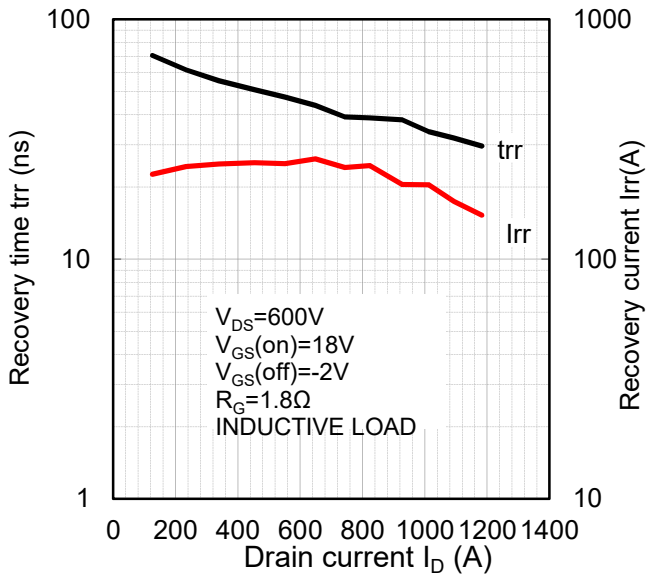
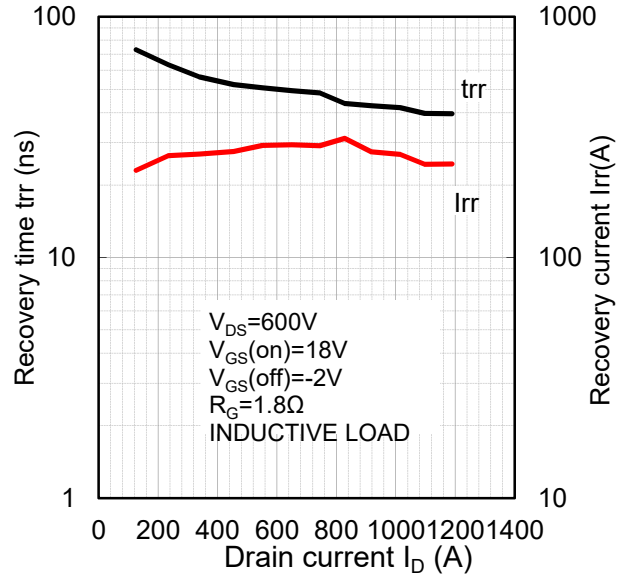

Fig.16 Recovery characteristic vs drain current at 125°C (TYP)



●Electrical characteristic curves (Typical)

Fig.17 Recovery characteristic vs drain current at 150°C (TYP)

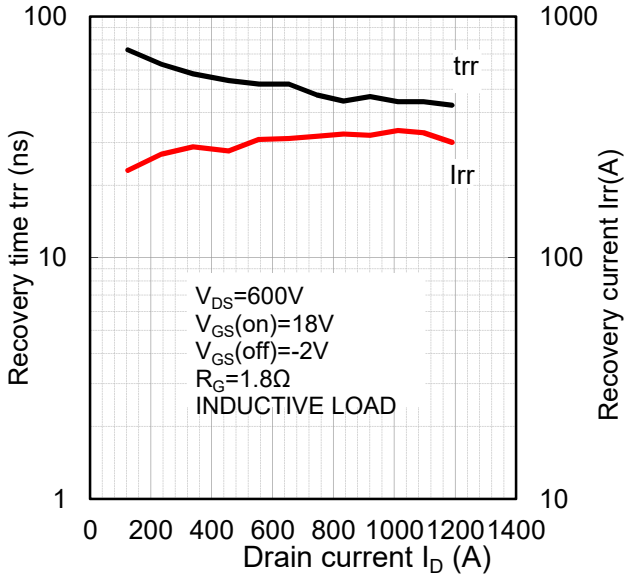

Fig.18 Switching time vs gate resistance at 25°C (TYP)

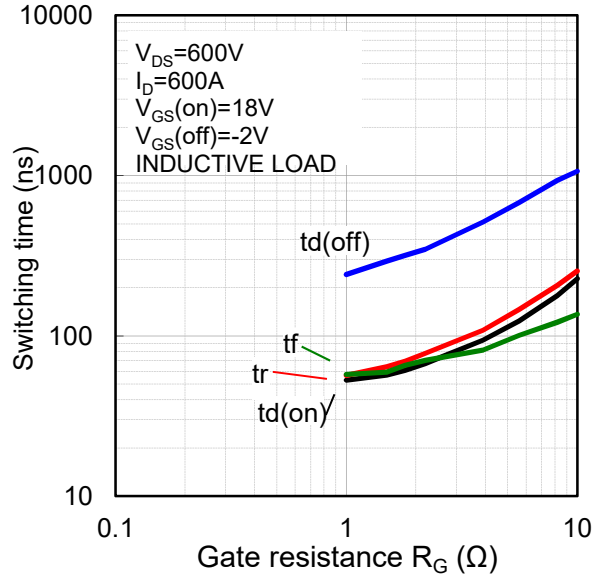

Fig.19 Switching time vs gate resistance at 125°C (TYP)

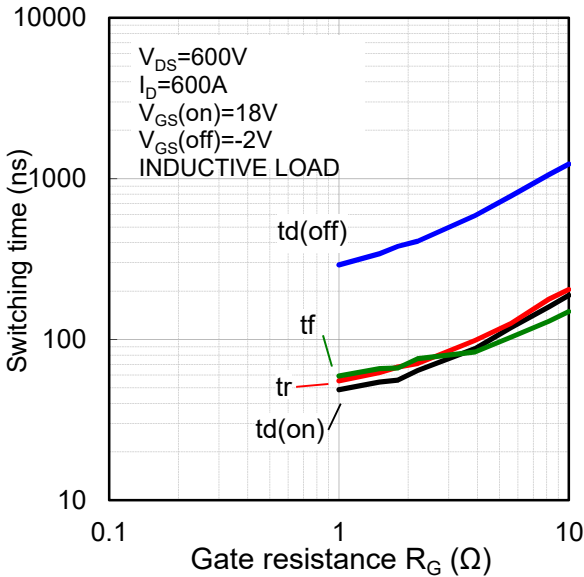
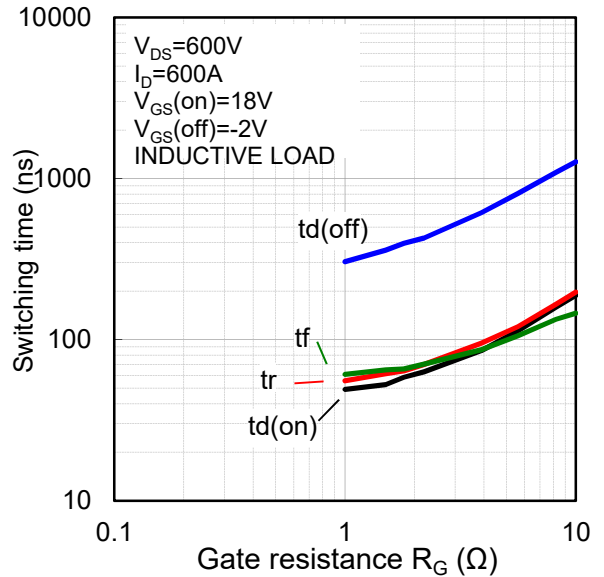

Fig.20 Switching time vs gate resistance at 150°C (TYP)



●Electrical characteristic curves (Typical)

Fig.21 Switching loss vs gate resistance at 25°C (TYP)

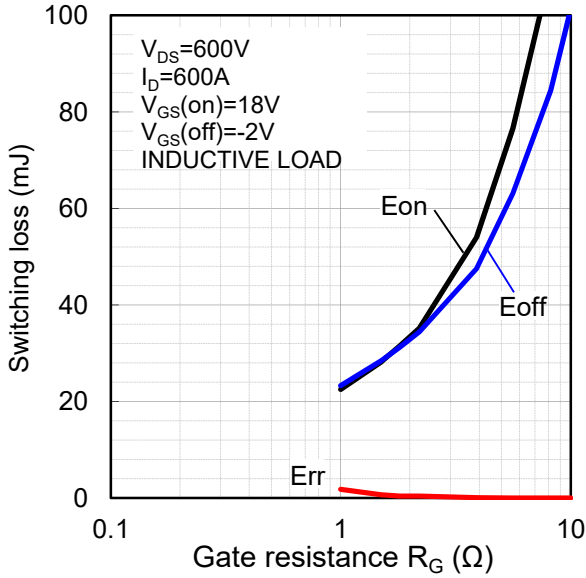

Fig.22 Switching loss vs gate resistance at 125°C (TYP)

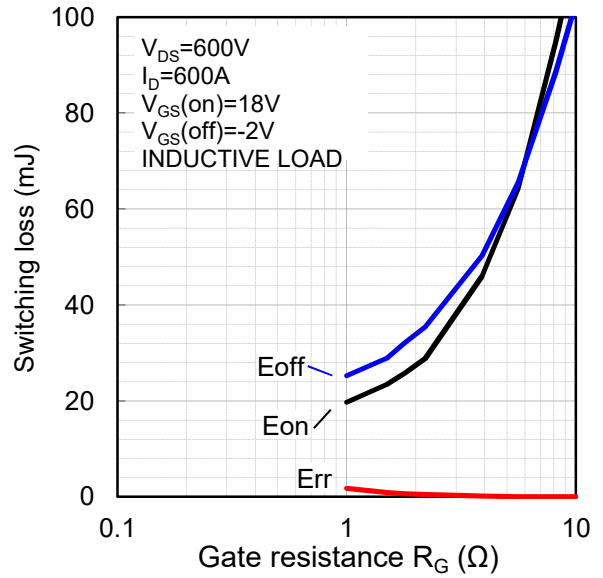
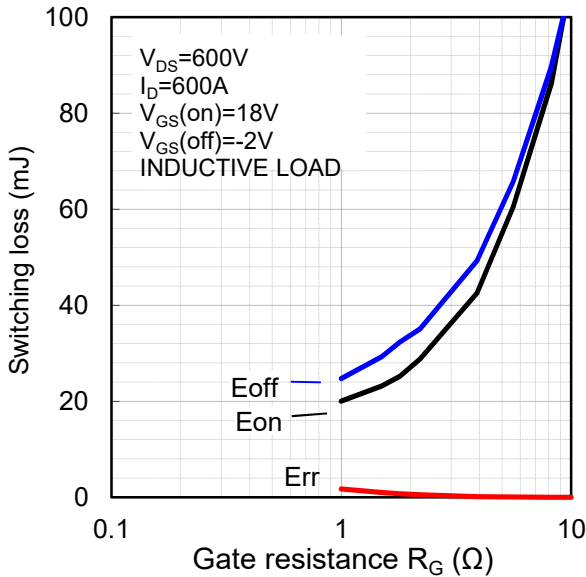

Fig.23 Switching loss vs gate resistance at 150°C (TYP)



●Electrical characteristic curves (Typical)

Fig.24 Capacitance vs Drain source voltage (TYP)

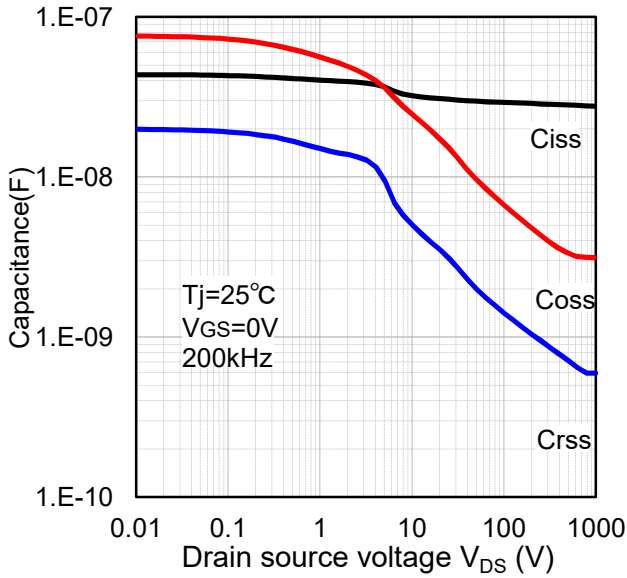

Fig.25 Gate charge characteristic (TYP)

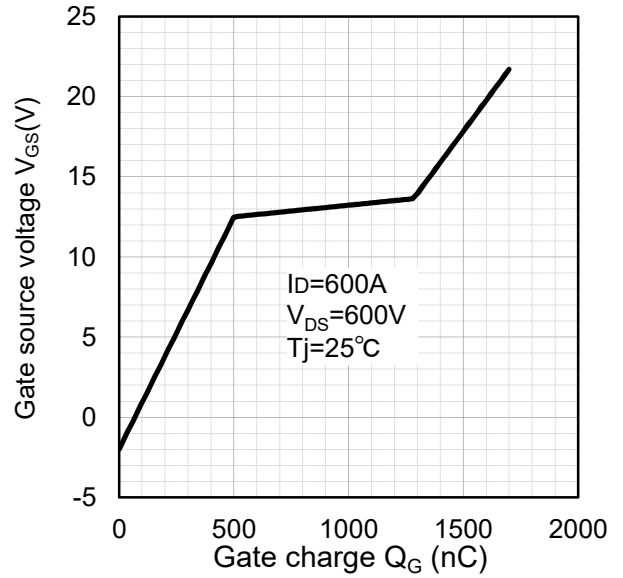
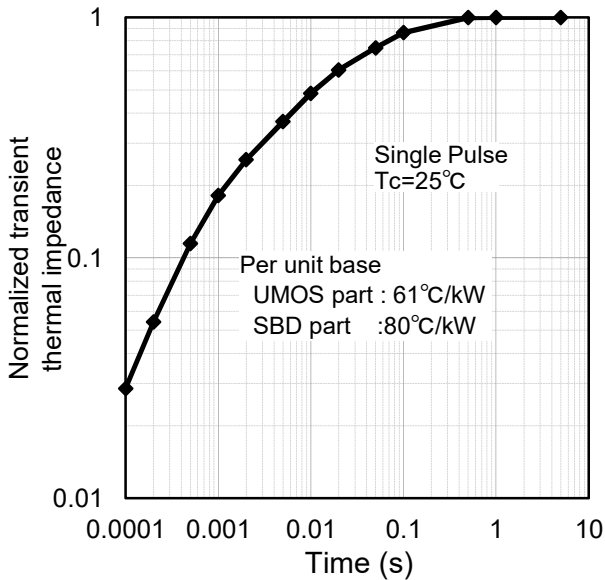

Fig.26 Transient thermal impedance (TYP)



Notes

- 1) The information contained herein is subject to change without notice.
- 2) Before you use our Products, please contact our sales representative and verify the latest specifications.
- 3) Although ROHM is continuously working to improve product reliability and quality, semiconductors can break down and malfunction due to various factors. Therefore, in order to prevent personal injury or fire arising from failure, please take safety measures such as complying with the derating characteristics, implementing redundant and fire prevention designs, and utilizing backups and fail-safe procedures. ROHM shall have no responsibility for any damages arising out of the use of our Products beyond the rating specified by ROHM.
- 4) Examples of application circuits, circuit constants and any other information contained herein are provided only to illustrate the standard usage and operations of the Products. The peripheral conditions must be taken into account when designing circuits for mass production.
- 5) The technical information specified herein is intended only to show the typical functions of and examples of application circuits for the Products. ROHM does not grant you, explicitly or implicitly, any license to use or exercise intellectual property or other rights held by ROHM or any other parties. ROHM shall have no responsibility whatsoever for any dispute arising out of the use of such technical information.
- 6) The Products specified in this document are not designed to be radiation tolerant.
- 7) For use of our Products in applications requiring a high degree of reliability (as exemplified below), please contact and consult with a ROHM representative : transportation equipment (i.e. cars, ships, trains), primary communication equipment, traffic lights, fire/crime prevention, safety equipment, medical systems, and power transmission systems.
- 8) Do not use our Products in applications requiring extremely high reliability, such as aerospace equipment, nuclear power control systems, and submarine repeaters.
- 9) ROHM shall have no responsibility for any damages or injury arising from non-compliance with the recommended usage conditions and specifications contained herein.
- 10) ROHM has used reasonable care to ensure the accuracy of the information contained in this document. However, ROHM does not warrants that such information is error-free, and ROHM shall have no responsibility for any damages arising from any inaccuracy or misprint of such information.
- 11) Please use the Products in accordance with any applicable environmental laws and regulations, such as the RoHS Directive. For more details, including RoHS compatibility, please contact a ROHM sales office. ROHM shall have no responsibility for any damages or losses resulting non-compliance with any applicable laws or regulations.
- 12) When providing our Products and technologies contained in this document to other countries, you must abide by the procedures and provisions stipulated in all applicable export laws and regulations, including without limitation the US Export Administration Regulations and the Foreign Exchange and Foreign Trade Act.
- 13) This document, in part or in whole, may not be reprinted or reproduced without prior consent of ROHM.



Thank you for your accessing to ROHM product informations.
More detail product informations and catalogs are available, please contact us.

ROHM Customer Support System

<http://www.rohm.com/contact/>