



Read this document carefully before using this device. The guarantee will be expired by damaging of the device if you don't attend to the directions in the user manual. Also we don't accept any compensations for personal injury, material damage or capital disadvantages.

ENDA ET1124 DIN RAIL MOUNTED FOUR INPUT PID TEMPERATURE CONTROLLER

Thank you for choosing ENDA ET1124 Rail mounted PID temperature controller.

- ▶ DIN Rail Mounting.
- ▶ Selectable Dual-set value.
- ▶ J, K, L, T, S, R Thermocuple or two-wire PT00 sensor types (Specify at Order).
- ▶ **Automatic calculation of PID parameters (SELF TUNE).**



Selftune for automatic PID calculation or manually enter PID parameters if known.

- ▶ Control outputs can be cancelled (Used for measuring purposes).
- ▶ Four SSR temperature control outputs.
- ▶ SSR outputs can be controlled manually.
- ▶ Soft-Start feature.
- ▶ Communication via RS485 ModBus protocol.
- ▶ Heating / Cooling control selection.
- ▶ Zero point input shift (Offset feature for input).
- ▶ In case of sensor failure, SSR positions can be selected or periodic operation can be performed.
- ▶ Can be programmed via ModBus.
- ▶ Can be updated via RS485.
- ▶ CE Marked according to European Norms.

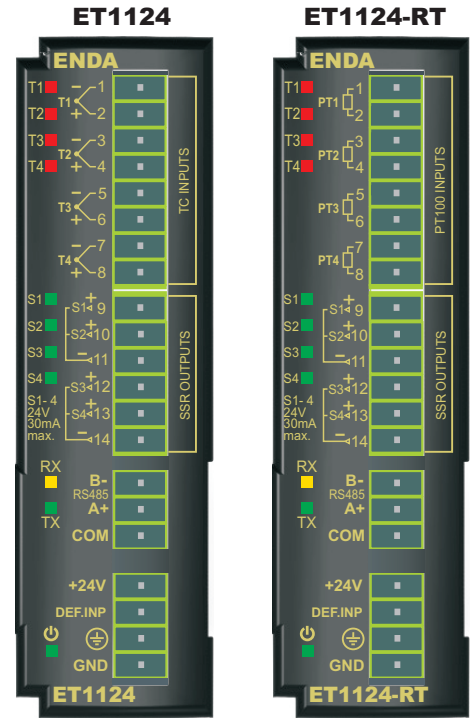

**RoHS
Compliant**



Order Code : ET1124A TC Input
ET1124A-RT PT100 Input

ENVIRONMENTAL CONDITIONS

Ambient/storage temperature	0 ... +50°C/-25 ... +70°C (with no icing).
Max. Relative humidity	80% Relative humidity for temperatures up to 31°C, decreasing linearly to 50% at 40°C.
Protection rating	According to EN 60529 IP20.
Height	Max. 2000m.



Do not use the device in locations subject to corrosive and flammable gases.

ELECTRICAL CHARACTERISTICS

Supply	24 VDC 20%.
Power consumption	Max. 5VA.
Wiring	1.5mm ² screw-terminal connections.
Line resistance	Max. 100Ω Ohm. for thermocouple. Max. 1 ohm. For PT100 (Correction may be required using with offset parameter).
Data retention	EEPROM (minimum 10 years).
EMC	EN 61326-1: 2013
Safety requirements	EN 61010-1: 2010 (Pollution degree 2, overvoltage category II)

INPUTS

T1...T4 Thermocouple inputs	Four input channels, J, K, L, T, S and R Thermocouple sensor inputs can be selected (for TC input devices - ET1124).
PT1...PT4 PT100 termo eleman girişi	Four channel PT100 Thermocouple sensor inputs (for PT100 input devices - ET1124-RT)

OUTPUTS

S1...S4 SSR Control outputs	Four outputs, Max. 24 VDC ±20% , 30mA short circuit protected SSR control.
-----------------------------	--

CONTROL

Control type	Single set-point control.
Control algorithm	On-Off / P, PI, PD, PID (selectable).
A/D converter	14 bits.
Sampling time	200ms (Minimum).
Proportional band	Adjustable between 0% and 100%. If Pb=0%, On-Off control is selected.
Integral time	Adjustable between 0.0 and 100.0 minutes.
Derivative time	Adjustable between 0.00 and 25.00 minutes.
Control period	Adjustable between 1 and 125 seconds.
Hysteresis	Adjustable between 1 and 50°C/F.
Output power	The ratio of power at a set point can be adjusted between 0% and 100% .

HOUSING

Housing type	Rail - mounted box according to DIN 43 700.
Dimensions	W29xH90xD64mm
Weight	Approx. 200g (after packing)
Enclosure material	Self extinguishing plastics used.



While cleaning the device, solvents (thinner, gasoline, acid etc.) or corrosive materials must not be used.



SİSEL MÜHENDİSLİK ELEKTRONİK SAN. VE TİC. A.Ş.
Şerifali Mah. Barbaros Cad. No:18 Y.Dudullu 34775
ÜMRANİYE/İSTANBUL
Tel : +90 216 499 46 64 Pbx. Fax : +90 216 365 74 01
www.enda.com.tr



ET1124A-EN-02-220103

TECHNICAL SPECIFICATIONS

		Input Type	Temperature Scale Range		Accuracy
ET1124-RT (PT100)	PT100 Resistance Thermometer	EN 60751	-199.9...600.0 °C	-199.9...999.9 °F	± 0,2% (for full scale) ± 1 Digit
	PT100 Resistance Thermometer	EN 60751	-200...600 °C	-328...1112 °F	± 0,2% (for full scale) ± 1 Digit
ET1124	J (Fe-CuNi) Thermocouple	EN 60584	-30.0...600.0°C	-22.0...999.9 °F	± 0,5% (for full scale) ± 1 Digit
	J (Fe-CuNi) Thermocouple	EN 60584	-30...600°C	-22...1112 °F	± 0,5% (for full scale) ± 1 Digit
	K (NiCr-Ni) Thermocouple	EN 60584	-30.0...999.9°C	-22.0...999.9 °F	± 0,5% (for full scale) ± 1 Digit
	K (NiCr-Ni) Thermocouple	EN 60584	-30...1300°C	-22...2372 °F	± 0,5% (for full scale) ± 1 Digit
	L (Fe-CuNi) Thermocouple	DIN 43710	-30.0...600.0°C	-22.0...999.9 °F	± 0,5% (for full scale) ± 1 Digit
	L (Fe-CuNi) Thermocouple	DIN 43710	-30...600°C	-22...1112 °F	± 0,5% (for full scale) ± 1 Digit
	T (Cu-CuNi) Thermocouple	EN 60584	-30.0...400.0°C	-22.0...752.0 °F	± 0,5% (for full scale) ± 1 Digit
	T (Cu-CuNi) Thermocouple	EN 60584	-30...400°C	-22...752 °F	± 0,5% (for full scale) ± 1 Digit
S (Pt10Rh-Pt) Thermocouple	EN 60584	-40...1700°C	-40...3092 °F	± 0,5% (for full scale) ± 1 Digit	
R (Pt13Rh-Pt) Thermocouple	EN 60584	-40...1700°C	-40...3092 °F	± 0,5% (for full scale) ± 1 Digit	

CONNECTION DIAGRAM

! WARNING ENDA ET1124 and ET1124-RT devices are intended for rail mounted installations. Make sure that the device is used only for intended purpose. The shielding must be grounded on the instrument side. During an installation, all of the cables that are connected to the device must be free of electrical power. The device must be protected against inadmissible humidity, vibrations, severe soiling. Make sure that the operation temperature is not exceeded. All input and output lines that are not connected to the supply network must be laid out as shielded and twisted cables. These cables should not be close to the power cables or components. The installation and electrical connections must be carried out by a qualified staff and must be according to the relevant locally applicable regulations.

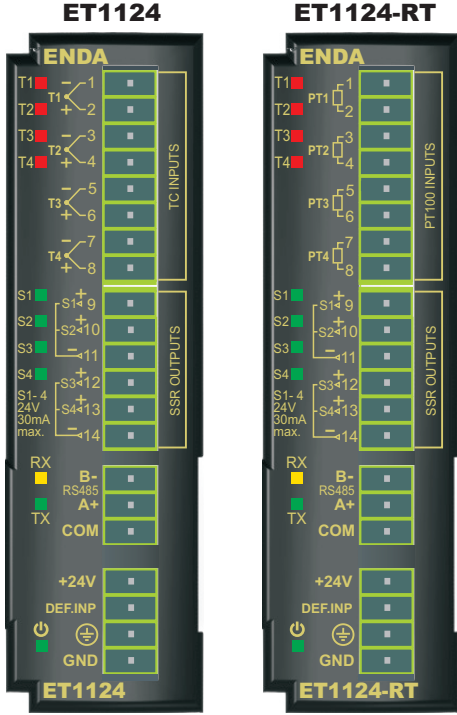

! WARNING Logic output of the instrument is not electrically insulated from the internal circuits. Therefore, when using a grounding thermocouple, do not connect the logic output terminals to the ground.

- 1) Mains supply cords shall meet the requirements of IEC 60227 or IEC 60245.
- 2) In accordance with the safety regulations, the power supply switch shall bring the identification of the relevant instrument and it should be easily accessible by the operator.

Holding screw 0.4-0.5Nm Equipment is protected throughout by DOUBLE INSULATION

ERROR MESSAGE DESCRIPTIONS for T1 (PT1) LED

! WARNING Graphics shown below are planned for the T1 LED. For T2 (PT2), T3 (PT3) and T4 (PT4) LEDs are same notation applies for according to the corresponding Input register parameter.

Parameter Number	Description
CH1 Input Register 13	Error codes for T1
0	No Error,
1	Short circuit or too low,
2	Lower scale,
3	Upper scale,
4	Thermocouple not connected,
5	Incorrect input selection

! WARNING Please see "Input Register Address Map" table on page 6/6 for details.

I3 = 1 ; Thermocouple sensor is short circuit or temperature is too low.



I3 = 2 ; Lower Scale

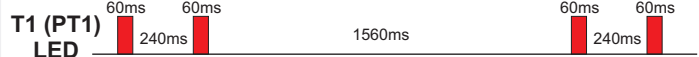

I3 = 3 ; Upper Scale



I3 = 4 ; Thermocouple not Connected

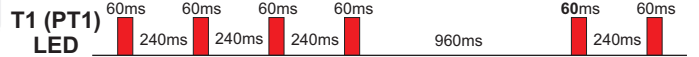

THERMOCOUPLE SENSOR INPUTS :

! WARNING For J-K-L-T-S-R type Thermocouples : Use the correct compensation cables for thermocouples. Do not use jointed cables. Make sure to connect to the right place and right polarities at the input terminals as shown in the figure.

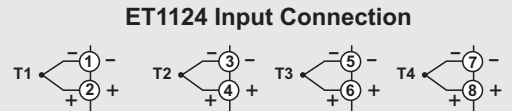

ET1124-RT Input Connection

For PT100 Input Devices : Use two-wire PT100 sensor without jointed cable. Long cable causes incorrect temperature measurement.

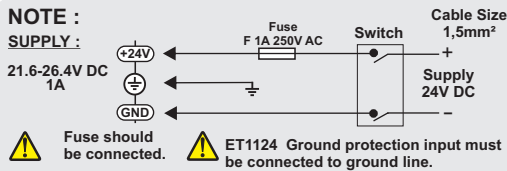

CONTROL OUTPUTS

CONTROL OUTPUTS :

Each of the four SSR control outputs can be applicable up to 30mA 24VDC load. SSR outputs are short circuit protected.

Holding screw 0.4-0.5Nm

Equipment is protected throughout by DOUBLE INSULATION

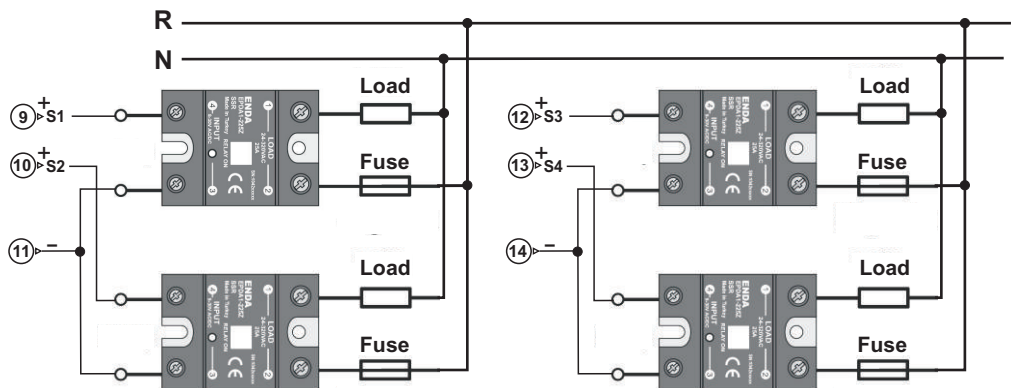

ORDER CODE : ET1124 TC Input
ET1124-RT PT100 Input

1.1 Memory Map for Thermostat Holding Registers

Parameter Number	Holding Register addresses Decimal (Hex)	Data Type	Data Content	Read / Write Permission	Factory defaults																																	
H0	0000d (0000h)	Word	Sensor parameter selection for PT1 Input (for ET1124-RT PT100 input devices) : 0 = PT100 Decimal 1 = PT100	R / W	1																																	
			Sensor parameter selection for T1 Input (for ET1124 TC input devices) : 2 = J (Decimal), 3 = J, 4 = K (Decimal), 5 = K, 6 = L (Decimal), 7 = L, 8 = T (Decimal), 9 = T, 10 = S, 11 = R,		3																																	
H1	0001d (0001h)	Word	Filter coefficient for T1 input (Can be set from 1 to 100. If set to 1, digital filter will be disabled)	R / W	20																																	
H2	0002d (0002h)	Word	Offset value for T1 input (Adjustable between -100 and 100)	R / W	0																																	
H3	0003d (0003h)	Word	Temperature setpoint value for S1 output (Adjustable between H5 and H6 parameters)	R / W	400																																	
H4	0004d (0004h)	Word	Secondary temperature setpoint value for S1 output (Adjustable between H5 and H6 parameters)	R / W	500																																	
H5	0005d (0005h)	Word	Minimum setpoint value for S1 output (Adjustable between Lower scale and H6 parameters)	R / W	0																																	
H6	0006d (0006h)	Word	Maximum setpoint value for S1 output (Adjustable between Upper scale and H5 parameters)	R / W	600																																	
H7	0007d (0007h)	Word	Proportional band set value for S1 output (Adjustable between 0.0 and 100.0%)	R / W	4.0																																	
H8	0008d (0008h)	Word	Hysteresis value for S1 output (Adjustable between 1 and 50 °C/°F)	R / W	2																																	
H9	0009d (0009h)	Word	Integral time value for S1 output (Adjustable between 0.0 and 100.0 minutes)	R / W	4.0																																	
H10	0010d (000Ah)	Word	Derivative time value for S1 output (Adjustable between 0.00 and 25.00 minutes)	R / W	1.00																																	
H11	0011d (000Bh)	Word	Period time set value for S1 output (Adjustable between 1 and 125 seconds)	R / W	25																																	
H12	0012d (000Ch)	Word	S1 output value at setpoint (Adjustable between 0.0% and 100.0%)	R / W	0.0																																	
H13	0013d (000Dh)	Word	S1 output value at sensor failure (Adjustable between 0.0% and 100.0%)	R / W	0.0																																	
H14	0014d (000Eh)	Word	Soft start time for S1 output at power-up (Adjustable between 0 and 250 minutes)	R / W	0																																	
H15	0015d (000Fh)	Word	Manual output percentage value for S1 output (Adjustable between 0.0% and 100.0%)	R / W	50.0																																	
H16	0016d (0010h)	Word	Function Control Parameter (Self tune stops if 23040d (5A00h) value is entered) (Self tune starts if 23041d (5A01h) value is entered) (If 23042d (5A02h) value is entered, CH1 parameters will return to factory values)	R / W	0																																	
H17	0017d (0011h)	Word	Configuration registers for CH1 (Holding registers for C0 - C15 configuration coils). <table border="1" style="margin: 5px auto; border-collapse: collapse;"> <tr> <td>B15</td><td>B14</td><td>B13</td><td>B12</td><td>B11</td><td>B10</td><td>B9</td><td>B8</td><td>B7</td><td>B6</td><td>B5</td><td>B4</td><td>B3</td><td>B2</td><td>B1</td><td>B0</td> </tr> <tr> <td>C7</td><td>C6</td><td>C5</td><td>C4</td><td>C3</td><td>C2</td><td>C1</td><td>C0</td><td>-</td><td>-</td><td>-</td><td>-</td><td>-</td><td>-</td><td>-</td><td>-</td> </tr> </table> See instructions on chapter 1.3 coil descriptions for the meaning of bits	B15	B14	B13	B12	B11	B10	B9	B8	B7	B6	B5	B4	B3	B2	B1	B0	C7	C6	C5	C4	C3	C2	C1	C0	-	-	-	-	-	-	-	-	R / W	1200H	
B15	B14	B13	B12	B11	B10	B9	B8	B7	B6	B5	B4	B3	B2	B1	B0																							
C7	C6	C5	C4	C3	C2	C1	C0	-	-	-	-	-	-	-	-																							
H18-49	0018d...0049d	Word	Reserved (32 word)	R / W	xx																																	
CH1 Output and Input Control Parameters	H50	0050d (0032h)	Word	Thermocouple sensor, parameter selections for T2 (Set such as H0)	R / W	3																																
	H51	0051d (0033h)	Word	Filter coefficient for T2 input (Can be set from 1 to 100. If set to 1, digital filter will be disabled)	R / W	20																																
	H52	0052d (0034h)	Word	Offset value for T2 input (Adjustable between -100 and 100)	R / W	0																																
	H53	0053d (0035h)	Word	Temperature setpoint value for S2 output (Adjustable between H55 and H56 parameters)	R / W	400																																
	H54	0054d (0036h)	Word	Secondary temperature setpoint value for S2 output (Adjustable between H55 and H56 parameters)	R / W	500																																
	H55	0055d (0037h)	Word	Minimum setpoint value for S2 output (Adjustable between Lower scale and H56 parameters)	R / W	0																																
	H56	0056d (0038h)	Word	Maximum setpoint value for S2 output (Adjustable between Upper scale and H55 parameters)	R / W	600																																
	H57	0057d (0039h)	Word	Proportional band set value for S2 output (Adjustable between 0.0 and 100.0%)	R / W	4.0																																
	H58	0058d (003Ah)	Word	Hysteresis value for S2 output (Adjustable between 1 - 50 °C/°F)	R / W	2																																
	H59	0059d (003Bh)	Word	Integral time value for S2 output (Adjustable between 0.0 and 100.0 minutes)	R / W	4.0																																
	H60	0060d (003Ch)	Word	Derivative time value for S2 output (Adjustable between 0.00 and 25.00 minutes)	R / W	1.00																																
	H61	0061d (003Dh)	Word	Period time set value for S2 output (Adjustable between 1 and 125 seconds)	R / W	25																																
	H62	0062d (003Eh)	Word	S2 output value at setpoint (Adjustable between 0.0% and 100.0%)	R / W	0.0																																
	H63	0063d (003Fh)	Word	S2 output value at sensor failure (Adjustable between 0.0% and 100.0%)	R / W	0.0																																
	H64	0064d (0040h)	Word	Soft start time for S2 output at power-up (Adjustable between 0 and 250 minutes)	R / W	0																																
	H65	0065d (0041h)	Word	Manual output percentage value for S2 output (Adjustable between 0.0% and 100.0%)	R / W	50.0																																
	H66	0066d (0042h)	Word	Function Control Parameter (Self tune stops if 23040d (5A00h) value is entered) (Self tune starts if 23041d (5A01h) value is entered) (If 23042d (5A02h) value is entered, CH2 parameters will return to factory values)	R / W	0																																
	H67	0067d (0043h)	Word	Configuration registers for CH2 (Holding registers for C50 - C65 configuration coils). <table border="1" style="margin: 5px auto; border-collapse: collapse;"> <tr> <td>B15</td><td>B14</td><td>B13</td><td>B12</td><td>B11</td><td>B10</td><td>B9</td><td>B8</td><td>B7</td><td>B6</td><td>B5</td><td>B4</td><td>B3</td><td>B2</td><td>B1</td><td>B0</td> </tr> <tr> <td>C57</td><td>C56</td><td>C55</td><td>C54</td><td>C53</td><td>C52</td><td>C51</td><td>C50</td><td>-</td><td>-</td><td>-</td><td>-</td><td>-</td><td>-</td><td>-</td><td>-</td> </tr> </table> See instructions on chapter 1.3 coil descriptions for the meaning of bits	B15	B14	B13	B12	B11	B10	B9	B8	B7	B6	B5	B4	B3	B2	B1	B0	C57	C56	C55	C54	C53	C52	C51	C50	-	-	-	-	-	-	-	-	R / W	1200H
	B15	B14	B13	B12	B11	B10	B9	B8	B7	B6	B5	B4	B3	B2	B1	B0																						
	C57	C56	C55	C54	C53	C52	C51	C50	-	-	-	-	-	-	-	-																						
H68-99	0068d...0099d	Word	Reserved (32 word)	R / W	xx																																	
CH2 Output and Input Control Parameters	H50	0050d (0032h)	Word	Thermocouple sensor, parameter selections for T2 (Set such as H0)	R / W	3																																
	H51	0051d (0033h)	Word	Filter coefficient for T2 input (Can be set from 1 to 100. If set to 1, digital filter will be disabled)	R / W	20																																
	H52	0052d (0034h)	Word	Offset value for T2 input (Adjustable between -100 and 100)	R / W	0																																
	H53	0053d (0035h)	Word	Temperature setpoint value for S2 output (Adjustable between H55 and H56 parameters)	R / W	400																																
	H54	0054d (0036h)	Word	Secondary temperature setpoint value for S2 output (Adjustable between H55 and H56 parameters)	R / W	500																																
	H55	0055d (0037h)	Word	Minimum setpoint value for S2 output (Adjustable between Lower scale and H56 parameters)	R / W	0																																
	H56	0056d (0038h)	Word	Maximum setpoint value for S2 output (Adjustable between Upper scale and H55 parameters)	R / W	600																																
	H57	0057d (0039h)	Word	Proportional band set value for S2 output (Adjustable between 0.0 and 100.0%)	R / W	4.0																																
	H58	0058d (003Ah)	Word	Hysteresis value for S2 output (Adjustable between 1 - 50 °C/°F)	R / W	2																																
	H59	0059d (003Bh)	Word	Integral time value for S2 output (Adjustable between 0.0 and 100.0 minutes)	R / W	4.0																																
	H60	0060d (003Ch)	Word	Derivative time value for S2 output (Adjustable between 0.00 and 25.00 minutes)	R / W	1.00																																
	H61	0061d (003Dh)	Word	Period time set value for S2 output (Adjustable between 1 and 125 seconds)	R / W	25																																
	H62	0062d (003Eh)	Word	S2 output value at setpoint (Adjustable between 0.0% and 100.0%)	R / W	0.0																																
	H63	0063d (003Fh)	Word	S2 output value at sensor failure (Adjustable between 0.0% and 100.0%)	R / W	0.0																																
	H64	0064d (0040h)	Word	Soft start time for S2 output at power-up (Adjustable between 0 and 250 minutes)	R / W	0																																
	H65	0065d (0041h)	Word	Manual output percentage value for S2 output (Adjustable between 0.0% and 100.0%)	R / W	50.0																																
	H66	0066d (0042h)	Word	Function Control Parameter (Self tune stops if 23040d (5A00h) value is entered) (Self tune starts if 23041d (5A01h) value is entered) (If 23042d (5A02h) value is entered, CH2 parameters will return to factory values)	R / W	0																																
	H67	0067d (0043h)	Word	Configuration registers for CH2 (Holding registers for C50 - C65 configuration coils). <table border="1" style="margin: 5px auto; border-collapse: collapse;"> <tr> <td>B15</td><td>B14</td><td>B13</td><td>B12</td><td>B11</td><td>B10</td><td>B9</td><td>B8</td><td>B7</td><td>B6</td><td>B5</td><td>B4</td><td>B3</td><td>B2</td><td>B1</td><td>B0</td> </tr> <tr> <td>C57</td><td>C56</td><td>C55</td><td>C54</td><td>C53</td><td>C52</td><td>C51</td><td>C50</td><td>-</td><td>-</td><td>-</td><td>-</td><td>-</td><td>-</td><td>-</td><td>-</td> </tr> </table> See instructions on chapter 1.3 coil descriptions for the meaning of bits	B15	B14	B13	B12	B11	B10	B9	B8	B7	B6	B5	B4	B3	B2	B1	B0	C57	C56	C55	C54	C53	C52	C51	C50	-	-	-	-	-	-	-	-	R / W	1200H
	B15	B14	B13	B12	B11	B10	B9	B8	B7	B6	B5	B4	B3	B2	B1	B0																						
	C57	C56	C55	C54	C53	C52	C51	C50	-	-	-	-	-	-	-	-																						
H68-99	0068d...0099d	Word	Reserved (32 word)	R / W	xx																																	

ENDA ET1124 MODBUS ADDRESS MAP

1.1 Memory Map for Thermostat Holding Registers (Continue)

Parameter Number	Holding Register addresses Decimal (Hex)	Data Type	Data Content	Read / Write Permission	Factory defaults	
CH3 Output and Input Control Parameters	H100	0100d (0064h)	Word	Thermocouple sensor, parameter selections for T3 (Set such as H0)	R / W	3
	H101	0101d (0065h)	Word	Filter coefficient for T3 input (Can be set from 1 to 100. If set to 1, digital filter will be disabled)	R / W	20
	H102	0102d (0066h)	Word	Offset value for T3 input (Adjustable between -100 and 100)	R / W	0
	H103	0103d (0067h)	Word	Temperature setpoint value for S3 output (Adjustable between H105 and H106 parameters)	R / W	400
	H104	0104d (0068h)	Word	Secondary temperature setpoint value for S3 output (Adjustable between H105 and H106 parameters)	R / W	500
	H105	0105d (0069h)	Word	Minimum setpoint value for S3 output (Adjustable between Lower scale and H106 parameters)	R / W	0
	H106	0106d (006Ah)	Word	Maximum setpoint value for S3 output (Adjustable between Upper scale and H105 parameters)	R / W	600
	H107	0107d (006Bh)	Word	Proportional band set value for S3 output (Adjustable between 0.0 and 100.0%)	R / W	4.0
	H108	0108d (006Ch)	Word	Hysteresis value for S3 output (Adjustable between 1 - 50 °C/°F)	R / W	2
	H109	0109d (006Dh)	Word	Integral time value for S3 output (Adjustable between 0.0 and 100.0 minutes)	R / W	4.0
	H110	0110d (006Eh)	Word	Derivative time value for S3 output (Adjustable between 0.00 and 25.00 minutes)	R / W	1.00
	H111	0111d (006Fh)	Word	Period time set value for S3 output (Adjustable between 1 and 125 seconds)	R / W	25
	H112	0112d (0070h)	Word	S3 output value at setpoint (Adjustable between 0.0% and 100.0%)	R / W	0.0
	H113	0113d (0071h)	Word	S3 output value at sensor failure (Adjustable between 0.0% and 100.0%)	R / W	0.0
H114	0114d (0072h)	Word	Soft start time for S3 output at power-up (Adjustable between 0 and 250 minutes)	R / W	0	
H115	0115d (0073h)	Word	Manual output percentage value for S3 output (Adjustable between 0.0% and 100.0%)	R / W	50.0	
H116	0116d (0074h)	Word	Function Control Parameter (Self tune stops if 23040d (5A00h) value is entered) (Self tune starts if 23041d (5A01h) value is entered) (If 23042d (5A02h) value is entered, CH3 parameters will return to factory values)	R / W	0	
H117	0117d (0075h)	Word	Configuration registers for CH3 (Holding registers for C100 - C115 configuration coils). <div style="border: 1px solid black; padding: 2px; display: inline-block;"> B15 B14 B13 B12 B11 B10 B9 B8 B7 B6 B5 B4 B3 B2 B1 B0 C107 C106 C105 C104 C103 C102 C101 C100 - - - - - - - - - - </div> See instructions on chapter 1.3 coil descriptions for the meaning of bits	R / W	1200H	
H118-149	00118d...00149d	Word	Reserved (32 word)	R / W	xx	
CH4 Output and Input Control Parameters	H150	0150d (0096h)	Word	Thermocouple sensor, parameter selections for T4 (Set such as H0)	R / W	3
	H151	0151d (0097h)	Word	Filter coefficient for T4 input (Can be set from 1 to 100. If set to 1, digital filter will be disabled)	R / W	20
	H152	0152d (0098h)	Word	Offset value for T4 input (Adjustable between -100 and 100)	R / W	0
	H153	0153d (0099h)	Word	Temperature setpoint value for S4 output (Adjustable between H155 and H156 parameters)	R / W	400
	H154	0154d (009Ah)	Word	Secondary temperature setpoint value for S4 output (Adjustable between H155 and H156 parameters)	R / W	500
	H155	0155d (009Bh)	Word	Minimum setpoint value for S4 output (Adjustable between Lower scale and H156 parameters)	R / W	0
	H156	0156d (009Ch)	Word	Maximum setpoint value for S4 output (Adjustable between Upper scale and H155 parameters)	R / W	600
	H157	0157d (009Dh)	Word	Proportional band set value for S4 output (Adjustable between 0.0 and 100.0%)	R / W	4.0
	H158	0158d (009Eh)	Word	Hysteresis value for S4 output (Adjustable between 1 - 50 °C/°F)	R / W	2
	H159	0159d (009Fh)	Word	Integral time value for S4 output (Adjustable between 0.0 and 100.0 minutes)	R / W	4.0
	H160	0160d (00A0h)	Word	Derivative time value for S4 output (Adjustable between 0.00 and 25.00 minutes)	R / W	1.00
	H161	0161d (00A1h)	Word	Period time set value for S4 output (Adjustable between 1 and 125 seconds)	R / W	25
	H162	0162d (00A2h)	Word	S4 output value at setpoint (Adjustable between 0.0% and 100.0%)	R / W	0.0
	H163	0163d (00A3h)	Word	S4 output value at sensor failure (Adjustable between 0.0% and 100.0%)	R / W	0.0
H164	0164d (00A4h)	Word	Soft start time for S4 output at power-up (Adjustable between 0 and 250 minutes)	R / W	0	
H165	0165d (00A5h)	Word	Manual output percentage value for S4 output (Adjustable between 0.0% and 100.0%)	R / W	50.0	
H166	0166d (00A6h)	Word	Function Control Parameter (Self tune stops if 23040d (5A00h) value is entered) (Self tune starts if 23041d (5A01h) value is entered) (If 23042d (5A02h) value is entered, CH4 parameters will return to factory values)	R / W	0	
H167	0167d (00A7h)	Word	Configuration registers for CH4 (Holding registers for C150 - C165 configuration coils). <div style="border: 1px solid black; padding: 2px; display: inline-block;"> B15 B14 B13 B12 B11 B10 B9 B8 B7 B6 B5 B4 B3 B2 B1 B0 C157 C156 C155 C154 C153 C152 C151 C150 - - - - - - - - - - </div> See instructions on chapter 1.3 coil descriptions for the meaning of bits	R / W	1200H	
H168-199	00168d...00199d	Word	Reserved (32 word)	R / W	xx	
General Control Parameters	H200	0200d (00C8h)	Word	Device address for Modbus (Adjustable between 1 and 247)	R / W	1
	H201	0201d (00C9h)	Word	Modbus baud rates: 0 = 1200 bps, 1 = 2400 bps, 2 = 4800 bps, 3 = 9600 bps, 4 = 14400 bps, 5 = 19200 bps, 6 = 38400 bps, 7 = 57600 bps ATTENTION !! : User must set Parity = None, Stop Bit = 1 and Data Length = 8 on the device that provides the Modbus connection. In ET1124 these settings are set as factory default and can not be changed by the user.	R / W	3



1.2 Memory Map for Control Coils

Parameter Number	Coil Addresses	Data Type	Data Content	Read / Write Permission	Factory defaults	
CH1 Coil Parameters	C0	0000d (0000h)	Bit	Configuration for S1 output (0 = Heating , 1 = Cooling)	R / W	0
	C1	0001d (0001h)	Bit	S1 Control output activation (0 = Display mode (Outputs Off), 1 = Output S1 active)	R / W	1
	C2	0002d (0002h)	Bit	Temperature set value selection for S1 (Temperature control performed according to H3 parameters if C2 parameter is set to 0) (Temperature control performed according to H4 parameters if C2 parameter is set to 1)	R / W	0
	C3	0003d (0003h)	Bit	Manual control bit for S1 output. (C3 = 0 Automatic control. If C3 = 1, S1 output according to output percentage in the parameter)	R / W	0
	C4	0004d (0004h)	Bit	Not used	R / W	1
	C5	0005d (0005h)	Bit	In case of sensor failure, S1 output format selection bit at T1 sensor output. (If C5 = 0, According to the percentage value in H13 parameter at T1) (If C5 = 1, According to the last proportional value in setpoint)	R / W	0
	C6	0006d (0006h)	Bit	Decimal point value for T1 sensor (0 = 0, 1 = 0.0)	R / W	0
C7	0007d (0007h)	Bit	Temperature unit for T1 sensor (0 = °C, 1 = °F)	R / W	0	
CH2 Coil Parameters	C50	0050d (0032h)	Bit	Output configuration for S2 (0 = Heating , 1 = Cooling)	R / W	0
	C51	0051d (0033h)	Bit	S2 Control output activation (0 = Display mode (Outputs Off), 1 = Output S1 active)	R / W	1
	C52	0052d (0034h)	Bit	Temperature set value selection for S2 (Temperature control performed according to H53 parameters if C52 parameter is set to 0) (Temperature control performed according to H54 parameters if C52 parameter is set to 1)	R / W	0
	C53	0053d (0035h)	Bit	Manual control bit for S2 output. (C53 = 0 Automatic control. If C53 = 1, S2 output according to H65 output percentage in the parameter)	R / W	0
	C54	0054d (0036h)	Bit	Not used	R / W	1
	C55	0055d (0037h)	Bit	In case of sensor failure, S2 output format selection bit at T2 sensor output. (If C55 = 0, According to the percentage value in H63 parameter at T2) (If C55 = 1, According to the last proportional value in setpoint)	R / W	0
	C56	0056d (0038h)	Bit	Decimal point for T2 sensor (0 = 0, 1 = 0.0)	R / W	0
C57	0057d (0039h)	Bit	Temperature unit for T2 sensor (0 = °C, 1 = °F)	R / W	0	
CH3 Coil Parameters	C100	0100d (0064h)	Bit	Output configuration for S3 (0 = Heating , 1 = Cooling)	R / W	0
	C101	0101d (0065h)	Bit	S3 Control output activation (0 = Display mode (Outputs Off), 1 = Output S1 active)	R / W	1
	C102	0102d (0066h)	Bit	Temperature set value selection for S3 (Temperature control performed according to H103 parameters if C102 parameter is set to 0) (Temperature control performed according to H104 parameters if C102 parameter is set to 1)	R / W	0
	C103	0103d (0067h)	Bit	Manual control bit for S3 output. (C103 = 0 Automatic control. If C103 = 1, S3 output according to H115 output percentage in the parameter)	R / W	0
	C104	0104d (0068h)	Bit	Not used	R / W	1
	C105	0105d (0069h)	Bit	In case of sensor failure, S3 output format selection bit at T3 sensor output. (If C105 = 0, According to the percentage value in H115 parameter at T3) (If C105 = 1, According to the last proportional value in setpoint)	R / W	0
	C106	0106d (006Ah)	Bit	Decimal point for T3 sensor (0 = 0, 1 = 0.0)	R / W	0
C107	0107d (006Bh)	Bit	Temperature unit for T3 sensor (0 = °C, 1 = °F)	R / W	0	
CH4 Coil Parameters	C150	0150d (0096h)	Bit	Output configuration for S4 (0 = Heating , 1 = Cooling)	R / W	0
	C151	0151d (0097h)	Bit	S4 Control output activation (0 = Display mode (Outputs Off), 1 = Output S1 active)	R / W	1
	C152	0152d (0098h)	Bit	Temperature set value selection for S4 (Temperature control performed according to H153 parameters if C152 parameter is set to 0) (Temperature control performed according to H154 parameters if C152 parameter is set to 1)	R / W	0
	C153	0153d (0099h)	Bit	Manual control bit for S4 output. (C153 = 0 Automatic control. If C153 = 1, S4 output according to H165 output percentage in the parameter)	R / W	0
	C154	0154d (009Ah)	Bit	Not used	R / W	1
	C155	0155d (009Bh)	Bit	In case of T4 sensor failure, S4 output format selection bit at T4 sensor output. (If C155 = 0, According to the percentage value in H165 parameter at T4) (If C155 = 1, According to the last proportional value in setpoint)	R / W	0
	C156	0156d (009Ch)	Bit	Decimal point for T4 sensor (0 = 0, 1 = 0.0)	R / W	0
C157	0157d (009Dh)	Bit	Temperature unit for T4 sensor (0 = °C, 1 = °F)	R / W	0	

1.3 Memory Map for Output Status Indicator Bits

Parameter Number	Discrete Input Addresses	Data Type	Data Content	Read / Write Permission
D0	(0000)h	Bit	S1 Control output status (0 = OFF , 1 = ON)	Read Only
D1	(0001)h	Bit	S2 Control output status (0 = OFF , 1 = ON)	Read Only
D2	(0002)h	Bit	S3 Control output status (0 = OFF , 1 = ON)	Read Only
D3	(0003)h	Bit	S4 Control output status (0 = OFF , 1 = ON)	Read Only

1.4 Memory Map for Software Revision Input Registers

Software Revision	0920d (0398h)	14 Word	Software name and update date is in ASCII format and 14 word. Example : ET1124-01 09 Feb 2016. Memory Format : Word Word Word Word Word Word Word Word Word Word Word Word Word Word Word Word 1 2 3 4 5 6 7 8 9 10 11 12 13 14 T E 1 1 4 2 0 - 1 9 0 F b e 2 1 0 . 6	Read Only
NOT: To view each word correctly by changing the byte sequences should be displayed as ASCII TEXT				

ENDA ET1124 MODBUS ADDRESS MAP

1.5 Memory Map for Input Registerlers

	Parameter Number	Holding Register addresses Decimal (Hex)	Data Type	Data Content	Read / Write Permission
CH1 input register	I0	0000d (0000h)	Word	T1 input temperature value (If C6 = 1 , decimal value)	Read Only
	I1	0001d (0001h)	Word	S1 active temperature set value	Read Only
	I2	0002d (0002h)	Word	S1 output power percentage	Read Only
	I3	0003d (0003h)	Word	T1 input error codes 0 = No error, 1 = Sensor short circuit, 2 = Lower scale error, 3 = Upper scale error, 4 = Sensor broken or not connected, 5 = Invalid input selection	Read Only
	I4	0004d (0004h)	Word	S1 Self tune codes 0 = No error, 1 = Initial temperature higher than 60% of the set value, 2 = PID Calculating, 3 = Power set parameter calculating	Read Only
CH2 input register	I50	0050d (0032h)	Word	T2 input temperature value (If C56 = 1 , decimal value)	Read Only
	I51	0051d (0033h)	Word	S2 active temperature set value	Read Only
	I52	0052d (0034h)	Word	S2 output power percentage	Read Only
	I53	0053d (0035h)	Word	T2 input error codes (See T1 error codes)	Read Only
	I54	0054d (0036h)	Word	S2 Self tune codes (See S1 Self tune codes)	Read Only
CH3 input register	I100	0100d (0064h)	Word	T3 input temperature value (If C106 = 1 , decimal value)	Read Only
	I101	0101d (0065h)	Word	S3 active temperature set value	Read Only
	I102	0102d (0066h)	Word	S3 output power percentage	Read Only
	I103	0103d (0067h)	Word	T3 input error codes (See T1 error codes)	Read Only
	I104	0104d (0068h)	Word	S3 Self tune codes (See S1 Self tune codes)	Read Only
CH4 input register	I150	0150d (0096h)	Word	T4 input temperature value (If C156 = 1 , decimal value)	Read Only
	I151	0151d (0097h)	Word	S4 active temperature set value	Read Only
	I152	0152d (0098h)	Word	S4 output power percentage	Read Only
	I153	0153d (0099h)	Word	T4 input error codes (See T1 error codes)	Read Only
	I154	0154d (009Ah)	Word	S4 Self tune codes (See S1 Self tune codes)	Read Only

MODBUS ERROR MESSAGES

Modbus protocol has two types error, communication error and operating error. Reason of the communication error is data corruption in transmission. Parity and CRC control should be done to prevent communication error. Receiver side checks parity and CRC of the data. If they are wrong, the message will be ignored. If format of the data is true but function doesn't perform for any reason, operating error occurs. Slave realizes error and sends error message. Most significant bit of function is changed '1' to indicate error in error message by slave. Error code is sent in data section. Master realizes error type via this message.

MODBUS ERROR CODES

Error Code	Name	Description
{01}	ILLEGAL FUNCTION	The function code received in the query is not an allowable action for the slave. If a Poll Program Complete command was issued, this code indicates
{02}	ILLEGAL DATA ADDRESS	The data address received in the query is not an allowable address for the slave.
{03}	ILLEGAL DATA VALUE	A value contained in the query data field is not an allowable value for the slave.

Message Sample ;

Structure of command message (Byte Format)

Device Address		(0A)h
Function Code		(01)h
Starting Address for Coils	MSB	(04)h
	LSB	(A1)h
Number of Coils to be read (N)	MSB	(00)h
	LSB	(01)h
CRC DATA	LSB	(AC)h
	MSB	(63)h

Structure of response message (Byte Format)

Device Address		(0A)h
Function Code		(81)h
Error Code		(02)h
CRC DATA	LSB	(B0)h
	MSB	(53)h

As you see in command message, coil information of (4A1)h = 1185 is required but there isn't any coil with 1185 address. Therefore error code with number (02) (Illegal Data Address) sends.

FACTORY SETTINGS



For restoring factory settings, follow the steps below :

- 1 - Power-off the device.
 - 2 - Short circuit the **DEF.INP** and **1St.** terminals of the connector.
 - 3 - Power-up the device and wait until all the LEDs flash.
 - 4 - Power-off the device when LEDs are start flashing.
 - 5 - Disconnect the short-circuited inputs and power-up the device.
- After step 5, device starts working with the factory settings.

ET1124

ET1124-RT

