

## 1 Msps/500 kSPS 16/14/12-Bit Single-Ended Input SAR ADC

### Features

- Sample Rate (Throughput):
  - MCP33131/21/11-10: 1 Msps
  - MCP33131/21/11-05: 500 kSPS
- 16/14/12-Bit Resolution with No Missing Codes
- No Latency Output
- Wide Operating Voltage Range:
  - Analog Supply Voltage ( $V_{DD}$ ): 1.8V
  - Digital Input/Output Interface Voltage ( $DV_{IO}$ ): 1.7V - 5.5V
  - External Reference ( $V_{REF}$ ): 2.5V - 5.1V
- Pseudo-Differential Input Operation with Single-Ended Configuration:
  - Input Full-Scale Range: 0V to  $+V_{REF}$
- Ultra Low Current Consumption (typical):
  - During Input Acquisition (Standby):  $\sim 0.8 \mu\text{A}$
  - During Conversion:
    - MCP331x1-10:  $\sim 1.6 \text{ mA}$
    - MCP331x1-05:  $\sim 1.4 \text{ mA}$
- SPI-Compatible Serial Communication:
  - SCLK Clock Rate: up to 100 MHz
- ADC Self-Calibration for Offset, Gain, and Linearity Errors:
  - During Power-Up (automatic)
  - On-Demand via user's command during normal operation
- AEC-Q100 Qualified:
  - Temperature Grade 1:  $-40^\circ\text{C}$  to  $+125^\circ\text{C}$
- Package Options: MSOP-10 and TDFN-10

### Typical Applications

- High-Precision Data Acquisition
- Medical Instruments
- Test Equipment
- Electric Vehicle Battery Management Systems
- Motor Control Applications
- Switch-Mode Power Supply Applications
- Battery-Powered Equipment

### System Design Supports

The MCP331x1-XX Evaluation Kit demonstrates the performance of the MCP331x1-XX SAR ADC family devices. The evaluation kit includes: (a) MCP331x1-XX Evaluation Board, (b) PIC32MZ EF Curiosity Board for data collection, and (c) SAR ADC Utility PC GUI.

Contact Microchip Technology Inc. for the evaluation tools and the PIC32 MCU firmware example codes.

### Package Types

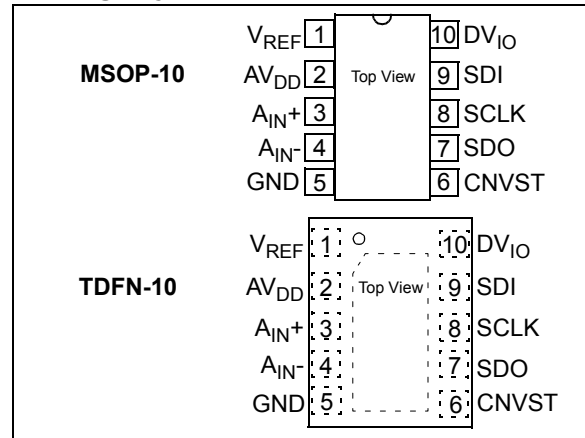

### MCP331x1-XX Device Offering (Note 1):

Part Number	Resolution	Sample Rate	Input Type	Input Range	Performance (Typical)				
					SNR (dBFS)	SFDR (dB)	THD (dB)	INL (LSB)	DNL (LSB)
MCP33131-10	16-bit	1 Msps	Single-Ended	0V to 5.1V	86.7	98.9	-97.4	$\pm 2.2$	$\pm 0.9$
MCP33121-10	14-bit	1 Msps	Single-Ended	0V to 5.1V	83.5	98.8	-97.2	$\pm 0.55$	$\pm 0.25$
MCP33111-10	12-bit	1 Msps	Single-Ended	0V to 5.1V	73.8	95.9	-93.7	$\pm 0.12$	$\pm 0.06$
MCP33131-05	16-bit	500 kSPS	Single-Ended	0V to 5.1V	86.7	98.9	-97.4	$\pm 2.2$	$\pm 0.9$
MCP33121-05	14-bit	500 kSPS	Single-Ended	0V to 5.1V	83.5	98.8	-97.2	$\pm 0.55$	$\pm 0.25$
MCP33111-05	12-bit	500 kSPS	Single-Ended	0V to 5.1V	73.8	95.9	-93.7	$\pm 0.12$	$\pm 0.06$

**Note 1:** SNR, SFDR, and THD are measured with  $f_{IN} = 10 \text{ kHz}$ ,  $V_{IN} = -1 \text{ dBFS}$ ,  $V_{REF} = 5.1\text{V}$ .

# MCP33131/21/11-XX

## Application Diagram

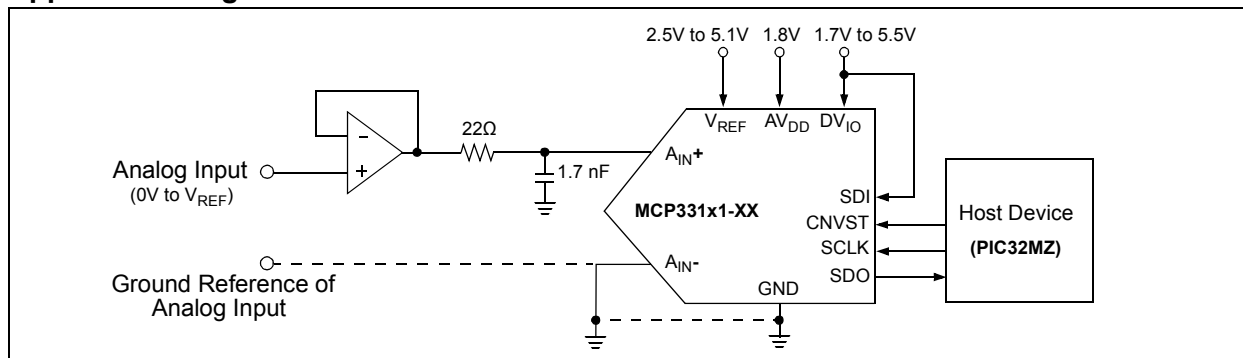

## Description

The MCP33131/MCP33121/MCP33111-10 and MCP33131/MCP33121/MCP33111-05 are single-ended 16, 14, and 12-bit, single-channel 1 Msps and 500 kSPS ADC family devices, respectively, featuring low power consumption and high performance, using a successive approximation register (SAR) architecture.

The device operates with a 2.5V to 5.1V external reference (V<sub>REF</sub>), which supports a wide range of input full-scale range from 0V to V<sub>REF</sub>. The reference voltage setting is independent of the analog supply voltage (AV<sub>DD</sub>) and is higher than AV<sub>DD</sub>. The conversion output is available through an easy-to-use simple SPI-compatible 3-wire interface.

The device requires a 1.8V analog supply voltage (AV<sub>DD</sub>) and a 1.7V to 5.5V digital I/O interface supply voltage (DV<sub>IO</sub>). The wide digital I/O interface supply (DV<sub>IO</sub>) range (1.7V - 5.5V) allows the device to interface with most host devices (Master) available in the current industry such as the PIC32 microcontrollers, without using external voltage level shifters.

When the device is first powered-up, it performs a self-calibration to minimize offset, gain and linearity errors. The device performance stays stable across the specified temperature range. However, when extreme changes in the operating environment, such as in the reference voltage, are made with respect to the initial conditions (e.g. the reference voltage was not fully settled during the initial power-up sequence), the user may send a recalibrate command anytime to initiate another self-calibration to restore optimum performance.

When the initial power-up sequence is completed, the device enters a low-current input acquisition mode, where sampling capacitors are connected to the input pins. This mode is called Standby.

During Standby, most of the internal analog circuitry is shutdown in order to reduce current consumption. Typically, the device consumes less than 1 μA during Standby. A new conversion is started on the rising edge of CNVST. When the conversion is complete and the host lowers CNVST, the output data is presented on SDO, and the device enters Standby to begin acquiring the next input sample. The user can clock out the ADC output data using the SPI-compatible serial clock during Standby.

The ADC system clock is generated by an internal on-chip clock, therefore the conversion is performed independent of the SPI serial clock (SCLK).

This device can be used for various high-speed and high-accuracy analog-to-digital data conversion applications, where design simplicity, low power, and no output latency are needed.

The device is AEC-Q100 qualified for automotive applications and operates over the extended temperature range of -40°C to +125°C. The available package options are Pb-free TDFN-10 and MSOP-10.

# MCP33131/MCP33121/MCP33111-XX

## 1.0 KEY ELECTRICAL CHARACTERISTICS

### 1.1 Absolute Maximum Ratings†

External Analog Supply Voltage (AV <sub>DD</sub> )	-0.3V to 2.0V
External Digital Supply Voltage (DV <sub>IO</sub> )	-0.3V to 5.8V
External Reference Voltage (V <sub>REF</sub> )	-0.3V to 5.8V
Analog Inputs w.r.t GND	-0.3V to V <sub>REF</sub> +0.3V
Current at Input Pins	±2 mA
Current at Output and Supply Pins	±250 mA
Storage Temperature	-65°C to +150°C
Maximum Junction Temperature (T <sub>J</sub> )	+150°C
ESD protection on all pins	≤ 2kV HBM, ≤ 2kV CDM, ≤ 200V MM

†**Notice:** Stresses above those listed under “Absolute Maximum Ratings” may cause permanent damage to the device. This is a stress rating only and functional operation of the device at those or any other conditions above those indicated in the operational listings of this specification is not implied. Exposure to maximum rating conditions for extended periods may affect device reliability.

### 1.2 Electrical Specifications

**TABLE 1-1: KEY ELECTRICAL CHARACTERISTICS**

Parameters	Sym.	Min.	Typ.	Max.	Units	Conditions
<b>Electrical Specifications:</b> Unless otherwise specified, all parameters apply for T <sub>A</sub> = -40°C to +125°C, AV <sub>DD</sub> = 1.8V, DV <sub>IO</sub> = 3.3V, V <sub>REF</sub> = 5V, GND = 0V, Analog Input (V <sub>IN</sub> ) = -1 dBFS sine wave, f <sub>IN</sub> = 10 kHz, C <sub>LOAD_SDO</sub> = 20 pF.						
• MCP331x1-10: Sample Rate (f <sub>S</sub> ) = 1 Msps, SPI Clock Input (SCLK) = 60 MHz.						
• MCP331x1-05: Sample Rate (f <sub>S</sub> ) = 500 kSPS, SPI Clock Input (SCLK) = 30 MHz.						
<b>Power Supply Requirements</b>						
Analog Supply Voltage Range	AV <sub>DD</sub>	1.7	1.8	1.9	V	(Note 3)
Digital Input/Output Interface Voltage Range	DV <sub>IO</sub>	1.7	—	5.5	V	(Note 3)
Analog Supply Current at AV <sub>DD</sub> pin: During Conversion	I <sub>DDAN</sub>	—	1.6	2.4	mA	f <sub>S</sub> = 1 Msps (MCP331x1-10)
During Standby	I <sub>DDAN_STBY</sub>	—	0.8	—	μA	f <sub>S</sub> = 500 kSPS (MCP331x1-05) During input acquisition (t <sub>ACQ</sub> )
Digital Supply Current At DV <sub>DD</sub> pin: During Output Data Reading	I <sub>IO_DATA</sub>	—	290	—	μA	f <sub>S</sub> = 1 Msps (MCP331x1-10)
During Standby	I <sub>IO_STBY</sub>	—	30	—	nA	f <sub>S</sub> = 500 kSPS (MCP331x1-05) During input acquisition (t <sub>ACQ</sub> )
<b>External Reference Voltage Input</b>						
Reference Voltage (Note 2), (Note 3)	V <sub>REF</sub>	2.5 2.7	—	5.1 5.1	V	-40°C ≤ T <sub>A</sub> ≤ 85°C 85°C < T <sub>A</sub> ≤ 125°C
Reference Load Current at V <sub>REF</sub> pin: During Conversion	I <sub>REF</sub>	—	450	600	μA	f <sub>S</sub> = 1 Msps (MCP331x1-10)
During Standby	I <sub>REF_STBY</sub>	—	220 240	360 —	μA nA	f <sub>S</sub> = 500 kSPS (MCP331x1-05) During input acquisition (t <sub>ACQ</sub> )
<b>Total Power Consumption (Including AV<sub>DD</sub>, DV<sub>IO</sub>, V<sub>REF</sub> pins)</b>						
<b>MCP331x1-10</b>						
at 1 Msps	P <sub>DISS_TOTAL</sub>	—	6.2	—	mW	Averaged power for t <sub>ACQ</sub> + t <sub>CNV</sub>
at 500 ksp/s		—	3.1	—	mW	
at 100 ksp/s		—	0.6	—	mW	
During Standby	P <sub>DISS_STBY</sub>	—	2.6	—	μW	During input acquisition (t <sub>ACQ</sub> )
<b>MCP331x1-05</b>						
at 500 ksp/s	P <sub>DISS_TOTAL</sub>	—	4.2	—	mW	Averaged power for t <sub>ACQ</sub> + t <sub>CNV</sub>
at 100 ksp/s		—	0.8	—	mW	
During Standby	P <sub>DISS_STBY</sub>	—	2.6	—	μW	During input acquisition (t <sub>ACQ</sub> )

- Note**
- 1: This parameter is ensured by design and not 100% tested.
  - 2: This parameter is ensured by characterization and not 100% tested.
  - 3: Decoupling capacitor is recommended on the following pins:  
(a) AV<sub>DD</sub> pin: 1 μF ceramic capacitor, (b) DV<sub>IO</sub> pin: 0.1 μF ceramic capacitor, (c) V<sub>REF</sub> pin: 10 μF tantalum capacitor.
  - 4: PSRR (dB) = -20 log (D<sub>VOU</sub>T/AV<sub>DD</sub>), where D<sub>VOU</sub>T = change in conversion result.
  - 5: ENOB = (SINAD - 1.76)/6.02

# MCP33131/MCP33121/MCP33111-XX

**TABLE 1-1: KEY ELECTRICAL CHARACTERISTICS (CONTINUED)**

**Electrical Specifications:** Unless otherwise specified, all parameters apply for  $T_A = -40^{\circ}\text{C}$  to  $+125^{\circ}\text{C}$ ,  $AV_{DD} = 1.8\text{V}$ ,  $DV_{IO} = 3.3\text{V}$ ,  $V_{REF} = 5\text{V}$ ,  $\text{GND} = 0\text{V}$ , Analog Input ( $V_{IN}$ ) = -1 dBFS sine wave,  $f_{IN} = 10\text{ kHz}$ ,  $C_{LOAD\_SDO} = 20\text{ pF}$ .

- MCP331x1-10: Sample Rate ( $f_s$ ) = 1 Msps, SPI Clock Input (SCLK) = 60 MHz.
- MCP331x1-05: Sample Rate ( $f_s$ ) = 500 kSPS, SPI Clock Input (SCLK) = 30 MHz.

Parameters	Sym.	Min.	Typ.	Max.	Units	Conditions
<b>Analog Inputs</b>						
Input Voltage Range	$V_{IN+}$	-0.1	—	$V_{REF}+0.1$	V	(Note 2)
Input Full-Scale Voltage Range	FSR	0	—	$+V_{REF}$	$V_{PP}$	(Note 2)
Input Sampling Capacitance	$C_S$	—	31	—	pF	(Note 1)
-3dB Input Bandwidth	$BW_{-3dB}$	—	25	—	MHz	(Note 1)
Aperture Delay (Note 1)		—	2.5	—	ns	Time delay between CNVST rising edge and when input is sampled
Leakage Current at Analog Input Pin	$I_{LEAK\_AN\_INPUT}$	—	$\pm 2$	$\pm 200$	nA	During input acquisition ( $t_{ACQ}$ )
<b>System Performance</b>						
Sample Rate (Throughput rate)	$f_s$	—	—	1	Msps	MCP331x1-10
		—	—	500	kSPS	MCP331x1-05
Resolution (No Missing Codes)		16	—	—	Bits	MCP33131-10 and MCP33131-05
		14	—	—	Bits	MCP33121-10 and MCP33121-05
		12	—	—	Bits	MCP33111-10 and MCP33111-05
Integral Nonlinearity	INL	-6	$\pm 2.2$	+6	LSB	MCP33131-10 and MCP33131-05
		-1.5	$\pm 0.55$	+1.5	LSB	MCP33121-10 and MCP33121-05
		—	$\pm 0.12$	—	LSB	MCP33111-10 and MCP33111-05
Differential Nonlinearity	DNL	-0.98	$\pm 0.9$	+1.8	LSB	MCP33131-10 and MCP33131-05
		-0.8	$\pm 0.25$	+0.8	LSB	MCP33121-10 and MCP33121-05
		-0.3	$\pm 0.06$	+0.3	LSB	MCP33111-10 and MCP33111-05
Offset Error		—	$\pm 0.1$	$\pm 2.3$	mV	MCP33131-10 and MCP33131-05
		—	$\pm 0.125$	$\pm 3$	mV	MCP33121-10 and MCP33121-05
		—	$\pm 0.8$	$\pm 3.66$	mV	MCP33111-10 and MCP33111-05
Offset Error Drift with Temperature		—	$\pm 0.8$	—	$\mu\text{V}/^{\circ}\text{C}$	
Gain Error	$G_{ER}$	—	$\pm 4$	—	LSB	MCP33131-10 and MCP33131-05
		—	$\pm 1$	—	LSB	MCP33121-10 and MCP33121-05
		—	$\pm 0.2$	—	LSB	MCP33111-10 and MCP33111-05
Gain Error Drift with temperature		—	$\pm 0.35$	—	$\mu\text{V}/^{\circ}\text{C}$	
Input Common-Mode Rejection Ratio	CMRR	—	84	—	dB	
Power Supply Rejection Ratio	PSRR	—	60	—	dB	(Note 4)

- Note**
- 1: This parameter is ensured by design and not 100% tested.
  - 2: This parameter is ensured by characterization and not 100% tested.
  - 3: Decoupling capacitor is recommended on the following pins:  
(a)  $AV_{DD}$  pin: 1  $\mu\text{F}$  ceramic capacitor, (b)  $DV_{IO}$  pin: 0.1  $\mu\text{F}$  ceramic capacitor, (c)  $V_{REF}$  pin: 10  $\mu\text{F}$  tantalum capacitor.
  - 4:  $\text{PSRR (dB)} = -20 \log (D_{VOUT}/AV_{DD})$ , where  $D_{VOUT}$  = change in conversion result.
  - 5:  $\text{ENOB} = (\text{SINAD} - 1.76)/6.02$

# MCP33131/MCP33121/MCP33111-XX

**TABLE 1-1: KEY ELECTRICAL CHARACTERISTICS (CONTINUED)**

<b>Electrical Specifications:</b> Unless otherwise specified, all parameters apply for $T_A = -40^\circ\text{C}$ to $+125^\circ\text{C}$ , $AV_{DD} = 1.8\text{V}$ , $DV_{IO} = 3.3\text{V}$ , $V_{REF} = 5\text{V}$ , $GND = 0\text{V}$ , Analog Input ( $V_{IN}$ ) = -1 dBFS sine wave, $f_{IN} = 10\text{ kHz}$ , $C_{LOAD\_SDO} = 20\text{ pF}$ .							
<ul style="list-style-type: none"> <li>MCP331x1-10: Sample Rate (<math>f_S</math>) = 1 Msps, SPI Clock Input (SCLK) = 60 MHz.</li> <li>MCP331x1-05: Sample Rate (<math>f_S</math>) = 500 kSPS, SPI Clock Input (SCLK) = 30 MHz.</li> </ul>							
Parameters	Sym.	Min.	Typ.	Max.	Units	Conditions	
<b>Dynamic Performance</b>							
Signal-to-Noise Ratio	SNR	<b>MCP33131-10 and MCP33131-05: 16-bit ADC</b>					
		—	86.8	—	—	dBFS	$V_{REF} = 5\text{V}$ , $f_{IN} = 1\text{ kHz}$
		—	80.9	—	—	—	$V_{REF} = 2.5\text{V}$ , $f_{IN} = 1\text{ kHz}$
		83.5	86.7	—	—	—	$V_{REF} = 5\text{V}$ , $f_{IN} = 10\text{ kHz}$
		—	80.9	—	—	—	$V_{REF} = 2.5\text{V}$ , $f_{IN} = 10\text{ kHz}$
		<b>MCP33121-10 and MCP33121-05: 14-bit ADC</b>					
		—	83.6	—	—	dBFS	$V_{REF} = 5\text{V}$ , $f_{IN} = 1\text{ kHz}$
		—	79.8	—	—	—	$V_{REF} = 2.5\text{V}$ , $f_{IN} = 1\text{ kHz}$
		81.5	83.5	—	—	—	$V_{REF} = 5\text{V}$ , $f_{IN} = 10\text{ kHz}$
		—	79.8	—	—	—	$V_{REF} = 2.5\text{V}$ , $f_{IN} = 10\text{ kHz}$
		<b>MCP33111-10 and MCP33111-05: 12-bit ADC</b>					
		—	73.8	—	—	dBFS	$V_{REF} = 5\text{V}$ , $f_{IN} = 1\text{ kHz}$
		—	73.2	—	—	—	$V_{REF} = 2.5\text{V}$ , $f_{IN} = 1\text{ kHz}$
		71.1	73.8	—	—	—	$V_{REF} = 5\text{V}$ , $f_{IN} = 10\text{ kHz}$
		—	73.2	—	—	—	$V_{REF} = 2.5\text{V}$ , $f_{IN} = 10\text{ kHz}$
		Signal-to-Noise and Distortion Ratio (Note 5)	SINAD	<b>MCP33131-10 and MCP33131-05: 16-bit ADC</b>			
—	86.9			—	—	dBFS	$V_{REF} = 5\text{V}$ , $f_{IN} = 1\text{ kHz}$
—	80.9			—	—	—	$V_{REF} = 2.5\text{V}$ , $f_{IN} = 1\text{ kHz}$
—	86.6			—	—	—	$V_{REF} = 5\text{V}$ , $f_{IN} = 10\text{ kHz}$
—	80			—	—	—	$V_{REF} = 2.5\text{V}$ , $f_{IN} = 10\text{ kHz}$
<b>MCP33121-10 and MCP33121-05: 14-bit ADC</b>							
—	83.6			—	—	dBFS	$V_{REF} = 5\text{V}$ , $f_{IN} = 1\text{ kHz}$
—	79.8			—	—	—	$V_{REF} = 2.5\text{V}$ , $f_{IN} = 1\text{ kHz}$
—	83.4			—	—	—	$V_{REF} = 5\text{V}$ , $f_{IN} = 10\text{ kHz}$
—	79.1			—	—	—	$V_{REF} = 2.5\text{V}$ , $f_{IN} = 10\text{ kHz}$
<b>MCP33111-10 and MCP33111-05: 12-bit ADC</b>							
—	73.8			—	—	dBFS	$V_{REF} = 5\text{V}$ , $f_{IN} = 1\text{ kHz}$
—	73.2			—	—	—	$V_{REF} = 2.5\text{V}$ , $f_{IN} = 1\text{ kHz}$
—	73.8			—	—	—	$V_{REF} = 5\text{V}$ , $f_{IN} = 10\text{ kHz}$
—	73			—	—	—	$V_{REF} = 2.5\text{V}$ , $f_{IN} = 10\text{ kHz}$

- Note**
- 1: This parameter is ensured by design and not 100% tested.
  - 2: This parameter is ensured by characterization and not 100% tested.
  - 3: Decoupling capacitor is recommended on the following pins:  
(a)  $AV_{DD}$  pin: 1  $\mu\text{F}$  ceramic capacitor, (b)  $DV_{IO}$  pin: 0.1  $\mu\text{F}$  ceramic capacitor, (c)  $V_{REF}$  pin: 10  $\mu\text{F}$  tantalum capacitor.
  - 4:  $\text{PSRR (dB)} = -20 \log (D_{VOUT}/AV_{DD})$ , where  $D_{VOUT}$  = change in conversion result.
  - 5:  $\text{ENOB} = (\text{SINAD} - 1.76)/6.02$

# MCP33131/MCP33121/MCP33111-XX

**TABLE 1-1: KEY ELECTRICAL CHARACTERISTICS (CONTINUED)**

**Electrical Specifications:** Unless otherwise specified, all parameters apply for  $T_A = -40^{\circ}\text{C}$  to  $+125^{\circ}\text{C}$ ,  $AV_{DD} = 1.8\text{V}$ ,  $DV_{IO} = 3.3\text{V}$ ,  $V_{REF} = 5\text{V}$ ,  $\text{GND} = 0\text{V}$ , Analog Input ( $V_{IN}$ ) = -1 dBFS sine wave,  $f_{IN} = 10\text{ kHz}$ ,  $C_{LOAD\_SDO} = 20\text{ pF}$ .

- MCP331x1-10: Sample Rate ( $f_S$ ) = 1 Msps, SPI Clock Input (SCLK) = 60 MHz.
- MCP331x1-05: Sample Rate ( $f_S$ ) = 500 kSPS, SPI Clock Input (SCLK) = 30 MHz.

Parameters	Sym.	Min.	Typ.	Max.	Units	Conditions
Spurious Free Dynamic Range	SFDR	<b>MCP33131-10 and MCP33131-05: 16-bit ADC</b>				
		—	99.4	—	dBc	$V_{REF} = 5\text{V}$ , $f_{IN} = 1\text{ kHz}$
		—	94.4	—		$V_{REF} = 2.5\text{V}$ , $f_{IN} = 1\text{ kHz}$
		—	98.9	—		$V_{REF} = 5\text{V}$ , $f_{IN} = 10\text{ kHz}$
		—	93.9	—		$V_{REF} = 2.5\text{V}$ , $f_{IN} = 10\text{ kHz}$
		<b>MCP33121-10 and MCP33121-05: 14-bit ADC</b>				
		—	99.3	—	dBc	$V_{REF} = 5\text{V}$ , $f_{IN} = 1\text{ kHz}$
		—	94.4	—		$V_{REF} = 2.5\text{V}$ , $f_{IN} = 1\text{ kHz}$
		—	98.8	—		$V_{REF} = 5\text{V}$ , $f_{IN} = 10\text{ kHz}$
		—	93.9	—		$V_{REF} = 2.5\text{V}$ , $f_{IN} = 10\text{ kHz}$
		<b>MCP33111-10 and MCP33111-05: 12-bit ADC</b>				
		—	97.4	—	dBc	$V_{REF} = 5\text{V}$ , $f_{IN} = 1\text{ kHz}$
		—	94.2	—		$V_{REF} = 2.5\text{V}$ , $f_{IN} = 1\text{ kHz}$
		—	95.9	—		$V_{REF} = 5\text{V}$ , $f_{IN} = 10\text{ kHz}$
		—	93.7	—		$V_{REF} = 2.5\text{V}$ , $f_{IN} = 10\text{ kHz}$
		Total Harmonic Distortion (first five harmonics)	THD	<b>MCP33131-10 and MCP33131-05: 16-bit ADC</b>		
—	-97.6			—	dBc	$V_{REF} = 5\text{V}$ , $f_{IN} = 1\text{ kHz}$
—	-92.5			—		$V_{REF} = 2.5\text{V}$ , $f_{IN} = 1\text{ kHz}$
—	-97.4			—		$V_{REF} = 5\text{V}$ , $f_{IN} = 10\text{ kHz}$
—	-92.4			—		$V_{REF} = 2.5\text{V}$ , $f_{IN} = 10\text{ kHz}$
<b>MCP33121-10 and MCP33121-05: 14-bit ADC</b>						
—	-97.4			—	dBc	$V_{REF} = 5\text{V}$ , $f_{IN} = 1\text{ kHz}$
—	-92.4			—		$V_{REF} = 2.5\text{V}$ , $f_{IN} = 1\text{ kHz}$
—	-97.2			—		$V_{REF} = 5\text{V}$ , $f_{IN} = 10\text{ kHz}$
—	-92.3			—		$V_{REF} = 2.5\text{V}$ , $f_{IN} = 10\text{ kHz}$
<b>MCP33111-10 and MCP33111-05: 12-bit ADC</b>						
—	-94.4			—	dBc	$V_{REF} = 5\text{V}$ , $f_{IN} = 1\text{ kHz}$
—	-91.7			—		$V_{REF} = 2.5\text{V}$ , $f_{IN} = 1\text{ kHz}$
—	-93.7			—		$V_{REF} = 5\text{V}$ , $f_{IN} = 10\text{ kHz}$
—	-91.5			—		$V_{REF} = 2.5\text{V}$ , $f_{IN} = 10\text{ kHz}$

- Note**
- This parameter is ensured by design and not 100% tested.
  - This parameter is ensured by characterization and not 100% tested.
  - Decoupling capacitor is recommended on the following pins:
    - $AV_{DD}$  pin: 1  $\mu\text{F}$  ceramic capacitor, (b)  $DV_{IO}$  pin: 0.1  $\mu\text{F}$  ceramic capacitor, (c)  $V_{REF}$  pin: 10  $\mu\text{F}$  tantalum capacitor.
  - $\text{PSRR (dB)} = -20 \log (D_{VOUT}/AV_{DD})$ , where  $D_{VOUT}$  = change in conversion result.
  - $\text{ENOB} = (\text{SINAD} - 1.76)/6.02$

# MCP33131/MCP33121/MCP33111-XX

**TABLE 1-1: KEY ELECTRICAL CHARACTERISTICS (CONTINUED)**

<b>Electrical Specifications:</b> Unless otherwise specified, all parameters apply for $T_A = -40^\circ\text{C}$ to $+125^\circ\text{C}$ , $AV_{DD} = 1.8\text{V}$ , $DV_{IO} = 3.3\text{V}$ , $V_{REF} = 5\text{V}$ , $GND = 0\text{V}$ , Analog Input ( $V_{IN}$ ) = -1 dBFS sine wave, $f_{IN} = 10\text{ kHz}$ , $C_{LOAD\_SDO} = 20\text{ pF}$ .						
<ul style="list-style-type: none"> <li>• MCP331x1-10: Sample Rate (<math>f_S</math>) = 1 Msps, SPI Clock Input (SCLK) = 60 MHz.</li> <li>• MCP331x1-05: Sample Rate (<math>f_S</math>) = 500 kSPS, SPI Clock Input (SCLK) = 30 MHz.</li> </ul>						
Parameters	Sym.	Min.	Typ.	Max.	Units	Conditions
<b>System Self-Calibration</b>						
Self-Calibration Time	$t_{CAL}$	—	500	650	ms	(Note 2)
Number of SCLK Clocks for Recalibrate Command	$ReCal_{NSCLK}$	—	1024	—	clocks	Includes clocks for data bits
<b>Serial Interface Timing Information:</b> See <a href="#">Table 1-2</a>						
<b>Digital Inputs/Outputs</b>						
High-level Input voltage	$V_{IH}$	$0.7 * DV_{IO}$	—	$DV_{IO} + 0.3$	V	$DV_{IO} \geq 2.3\text{V}$
		$0.9 * DV_{IO}$	—	$DV_{IO} + 0.3$	V	$DV_{IO} < 2.3\text{V}$
Low-level input voltage	$V_{IL}$	-0.3	—	$0.3 * DV_{IO}$	V	$DV_{IO} \geq 2.3\text{V}$
		-0.3	—	$0.2 * DV_{IO}$	V	$DV_{IO} < 2.3\text{V}$
Hysteresis of Schmitt Trigger Inputs	$V_{HYST}$	—	$0.2 * DV_{IO}$	—	V	All digital inputs
Low-level output voltage	$V_{OL}$	—	—	$0.2 * DV_{IO}$	V	$I_{OL} = 500\text{ }\mu\text{A}$ (sink)
High-level output voltage	$V_{OH}$	$0.8 * DV_{IO}$	—	—	V	$I_{OL} = -500\text{ }\mu\text{A}$ (source)
Input leakage current	$I_{LI}$	—	—	$\pm 1$	$\mu\text{A}$	$CNVST/SDI/SCLK = GND$ or $DV_{IO}$
Output leakage current	$I_{LO}$	—	—	$\pm 1$	$\mu\text{A}$	Output is high-Z, $SDO = GND$ or $DV_{IO}$
Internal capacitance (all digital inputs and outputs)	$C_{INT}$	—	7	—	pF	$T_A = 25^\circ\text{C}$ (Note 1)

- Note**
- 1: This parameter is ensured by design and not 100% tested.
  - 2: This parameter is ensured by characterization and not 100% tested.
  - 3: Decoupling capacitor is recommended on the following pins:  
(a)  $AV_{DD}$  pin: 1  $\mu\text{F}$  ceramic capacitor, (b)  $DV_{IO}$  pin: 0.1  $\mu\text{F}$  ceramic capacitor, (c)  $V_{REF}$  pin: 10  $\mu\text{F}$  tantalum capacitor.
  - 4:  $PSRR$  (dB) =  $-20 \log(D_{VOUT}/AV_{DD})$ , where  $D_{VOUT}$  = change in conversion result.
  - 5:  $ENOB = (\text{SINAD} - 1.76)/6.02$

# MCP33131/MCP33121/MCP33111-XX

**TABLE 1-2: SERIAL INTERFACE TIMING SPECIFICATIONS**

**Electrical Specifications:** Unless otherwise specified, all parameters apply for  $T_A = -40^\circ\text{C}$  to  $+125^\circ\text{C}$ ,  $V_{DD} = 1.8\text{V}$ ,  $DV_{IO} = 3.3\text{V}$ ,  $\text{GND} = 0\text{V}$ , Analog Input ( $A_{IN}$ ) = -1 dBFS sine wave, Resolution = 16-bit (MCP33131-10),  $f_{IN} = 10\text{ kHz}$ ,  $C_{LOAD\_SDO} = 20\text{ pF}$ ,  $+25^\circ\text{C}$  is applied for typical value. All timings are measured at 50%. See [Figure 1-1](#) for timing diagram.

- MCP331x1-10: Sample Rate ( $f_S$ ) = 1 Msps, SPI Clock Input (SCLK) = 60 MHz.
- MCP331x1-05: Sample Rate ( $f_S$ ) = 500 kSPS, SPI Clock Input (SCLK) = 30 MHz.

Parameters	Symbol	Min.	Typ.	Max.	Units	Conditions
Serial Clock frequency	$f_{SCLK}$	—	—	100	MHz	See $t_{SCLK}$ specification
SCLK Period	$t_{SCLK}$	10	—	—	ns	$DV_{IO} \geq 3.3\text{V}$ , $f_{SCLK} = 100\text{ MHz (Max)}$
		12	—	—	ns	$DV_{IO} \geq 2.3\text{V}$ , $f_{SCLK} = 83.3\text{ MHz (Max)}$
		16	—	—	ns	$DV_{IO} \geq 1.7\text{V}$ , $f_{SCLK} = 62.5\text{ MHz (Max)}$
SCLK Low Time	$t_{SCLK\_L}$	3	—	—	ns	$DV_{IO} \geq 2.3\text{V}$
		4.5	—	—	ns	$DV_{IO} \geq 1.7\text{V}$
SCLK High Time	$t_{SCLK\_H}$	3	—	—	ns	$DV_{IO} \geq 2.3\text{V}$
		4.5	—	—	ns	$DV_{IO} \geq 1.7\text{V}$
Output Valid from SCLK Low	$t_{DO}$	—	—	9.5	ns	$DV_{IO} \geq 3.3\text{V}$
		—	—	12	ns	$DV_{IO} \geq 2.3\text{V}$
		—	—	16	ns	$DV_{IO} \geq 1.7\text{V}$
Quiet time	$t_{QUIET}$	10	—	—	ns	<a href="#">(Note 2)</a>
<b>3-Wire Operation:</b>						
SDI Valid Setup time	$t_{SU\_SDIH\_CNV}$	5	—	—	ns	SDI High to CNVST Rising Edge
CNVST Pulse Width High Time	$t_{CNVH}$	10	—	—	ns	
Output Enable Time	$t_{EN}$	—	—	10	ns	$DV_{IO} \geq 2.3\text{V}$
		—	—	15	ns	$DV_{IO} \geq 1.7\text{V}$
Output Disable Time	$t_{DIS}$	—	—	15	ns	<a href="#">(Note 2)</a>
<b>MCP331x1-10</b>						
Sample Rate	$f_S$	—	—	1	Msps	Throughput rate
Input Acquisition Time <a href="#">(Note 2)</a>	$t_{ACQ}$	290 250	300	—	ns	$-40^\circ\text{C} \leq T_A \leq 85^\circ\text{C}$ $85^\circ\text{C} < T_A \leq 125^\circ\text{C}$
Data Conversion Time	$t_{CNV}$	—	700	710 750	ns	$-40^\circ\text{C} \leq T_A \leq 85^\circ\text{C}$ $85^\circ\text{C} < T_A \leq 125^\circ\text{C}$
Time between Conversions	$t_{CYC}$	1	—	—	$\mu\text{s}$	$t_{CYC} = t_{ACQ} + t_{CNV}$ , $f_S = 1\text{ Msps}$
<b>MCP331x1-05</b>						
Sample Rate	$f_S$	—	—	500	kSPS	Throughput rate
Input Acquisition Time <a href="#">(Note 2)</a>	$t_{ACQ}$	700	800	—	ns	$-40^\circ\text{C} \leq T_A \leq 125^\circ\text{C}$
Data Conversion Time	$t_{CNV}$	—	1200	1300	ns	$-40^\circ\text{C} \leq T_A \leq 125^\circ\text{C}$
Time between Conversions	$t_{CYC}$	2	—	—	$\mu\text{s}$	$t_{CYC} = t_{ACQ} + t_{CNV}$ , $f_S = 500\text{ kSPS}$

- Note 1:** This parameter is ensured by design and not 100% tested.  
**Note 2:** This parameter is ensured by characterization and not 100% tested.

**TABLE 1-3: TEMPERATURE CHARACTERISTICS**

Parameters	Symbol	Min.	Typ.	Max.	Units	Conditions
<b>Temperature Ranges</b>						
Operating Temperature Range	$T_A$	-40	—	+125	$^\circ\text{C}$	<a href="#">(Note 1)</a>
Storage Temperature Range	$T_A$	-65	—	+150	$^\circ\text{C}$	<a href="#">(Note 1)</a>
<b>Thermal Package Resistance</b>						
Thermal Resistance, MSOP-10	$\theta_{JA}$	—	202	—	$^\circ\text{C/W}$	
Thermal Resistance, TDFN-10	$\theta_{JA}$	—	68	—	$^\circ\text{C/W}$	

- Note 1:** The internal junction temperature ( $T_J$ ) must not exceed the absolute maximum specification of  $+150^\circ\text{C}$ .



# MCP33131/MCP33121/MCP33111-XX

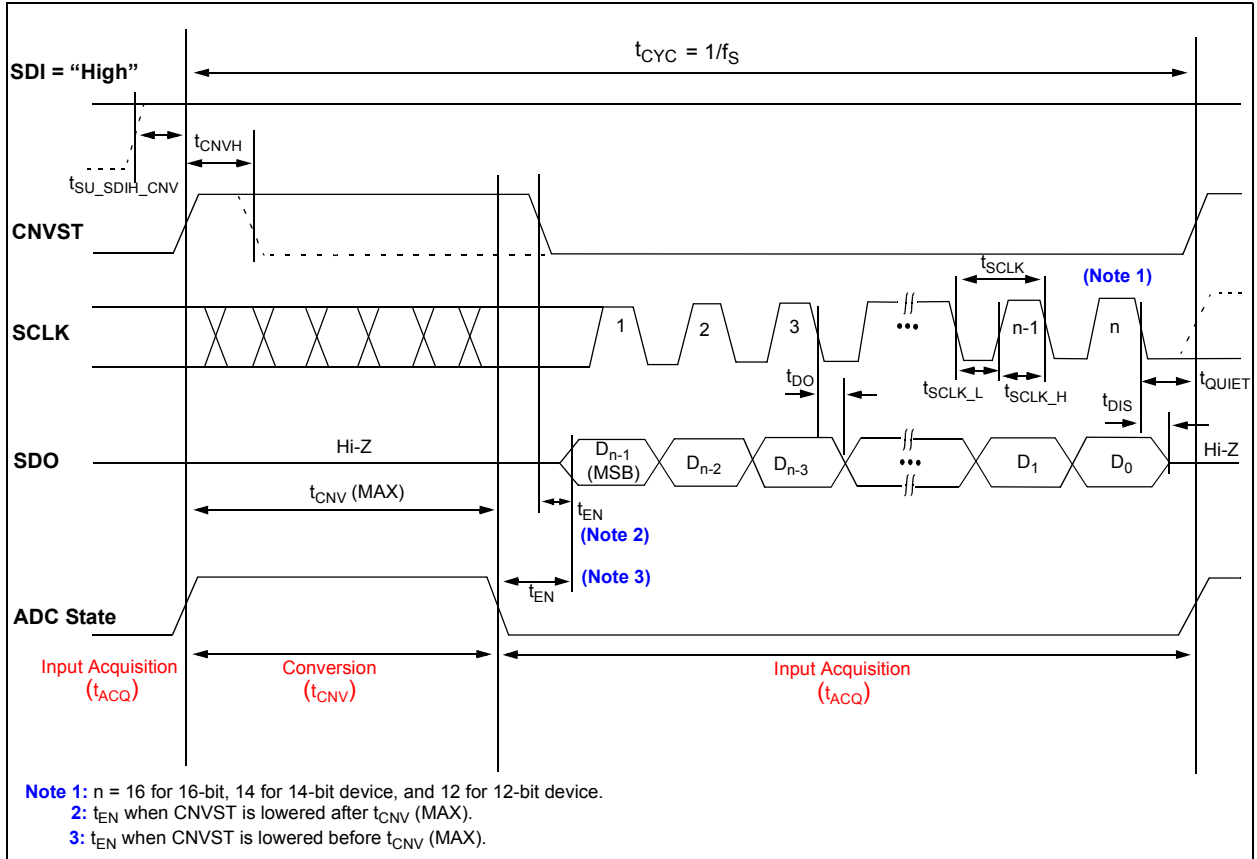

**FIGURE 1-1:** Interface Timing Diagram. CNVST is used as chip select. See Figure 7-2 for More Details.

# **MCP33131/MCP33121/MCP33111-XX**

---

---

**NOTES:**

# MCP33131/MCP33121/MCP33111-XX

## 2.0 TYPICAL PERFORMANCE CURVES FOR 16-BIT DEVICES (MCP33131-XX)

**Note:** The graphs and tables provided following this note are a statistical summary based on a limited number of samples and are provided for informational purposes only. The performance characteristics listed herein are not tested or guaranteed. In some graphs or tables, the data presented may be outside the specified operating range (e.g., outside specified power supply range) and therefore outside the warranted range.

**Note:** Unless otherwise specified, all parameters apply for  $T_A = +25^\circ\text{C}$ ,  $AV_{DD} = 1.8\text{V}$ ,  $DV_{IO} = 3.3\text{V}$ ,  $V_{REF} = 5\text{V}$ ,  $\text{GND} = 0\text{V}$ , Differential Analog Input ( $V_{IN}$ ) = -1 dBFS,  $f_{IN} = 10\text{ kHz}$ ,  $C_{LOAD\_SDO} = 20\text{ pF}$ .  
**MCP33131-10:** Sample Rate ( $f_S$ ) = 1 MspS, SPI Clock Input (SCLK) = 60 MHz.  
**MCP33131-05:** Sample Rate ( $f_S$ ) = 500 kSPS, SPI Clock Input (SCLK) = 30 MHz.

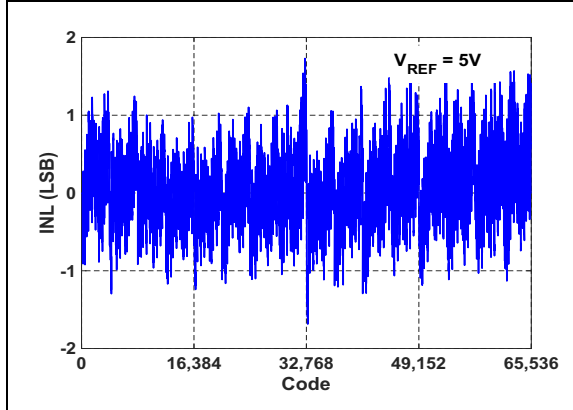

FIGURE 2-1: INL vs. Output Code.

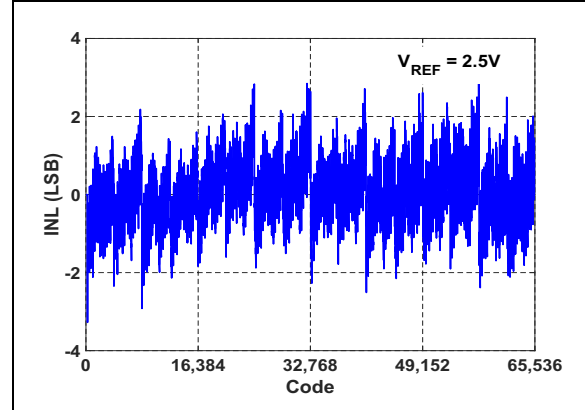

FIGURE 2-4: INL vs. Output Code.

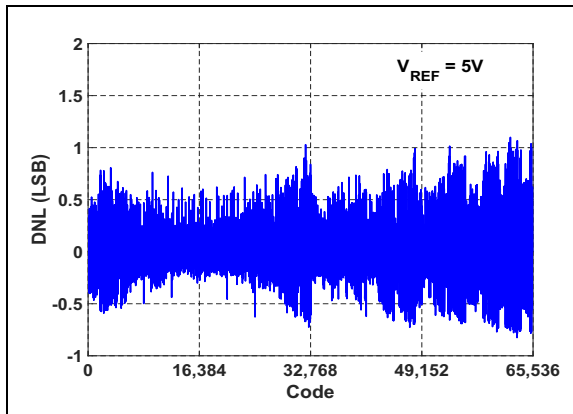

FIGURE 2-2: DNL vs. Output Code.

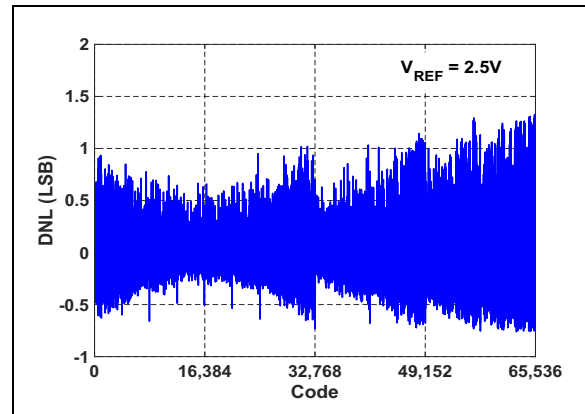

FIGURE 2-5: DNL vs. Output Code.

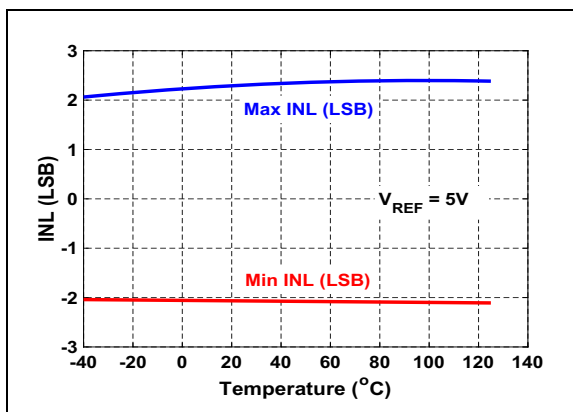

FIGURE 2-3: INL vs. Temperature.

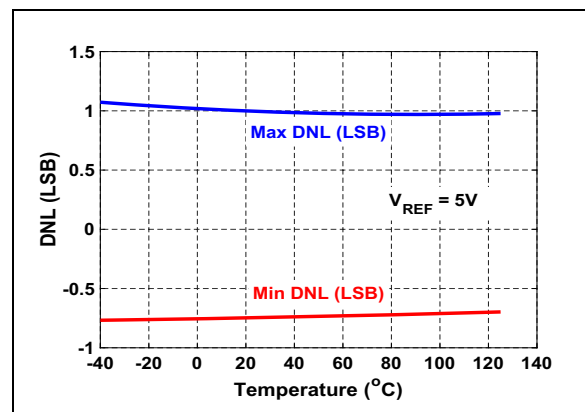
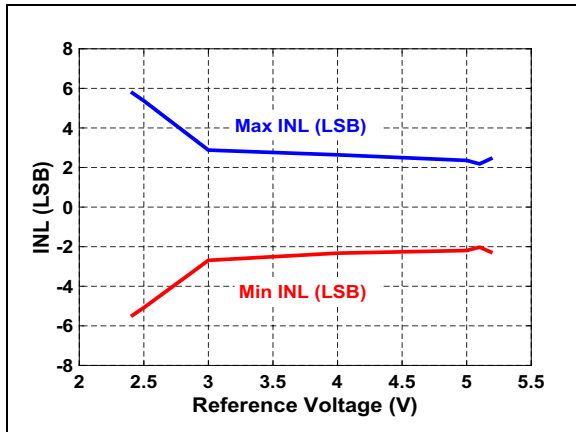

FIGURE 2-6: DNL vs. Temperature.

# MCP33131/MCP33121/MCP33111-XX

**Note:** Unless otherwise specified, all parameters apply for  $T_A = +25^\circ\text{C}$ ,  $AV_{DD} = 1.8\text{V}$ ,  $DV_{IO} = 3.3\text{V}$ ,  $V_{REF} = 5\text{V}$ ,  $\text{GND} = 0\text{V}$ , Differential Analog Input ( $V_{IN}$ ) = -1 dBFS,  $f_{IN} = 10\text{ kHz}$ ,  $C_{LOAD\_SDO} = 20\text{ pF}$ .  
**MCP33131-10:** Sample Rate ( $f_S$ ) = 1 MspS, SPI Clock Input (SCLK) = 60 MHz.  
**MCP33131-05:** Sample Rate ( $f_S$ ) = 500 kSPS, SPI Clock Input (SCLK) = 30 MHz.



**FIGURE 2-7:** INL vs. Reference Voltage.

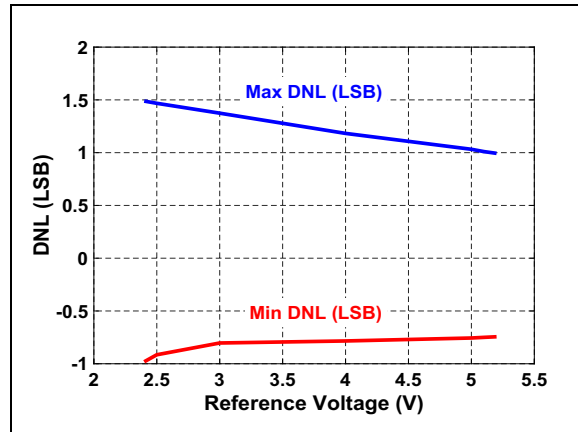

**FIGURE 2-10:** DNL vs. Reference Voltage.

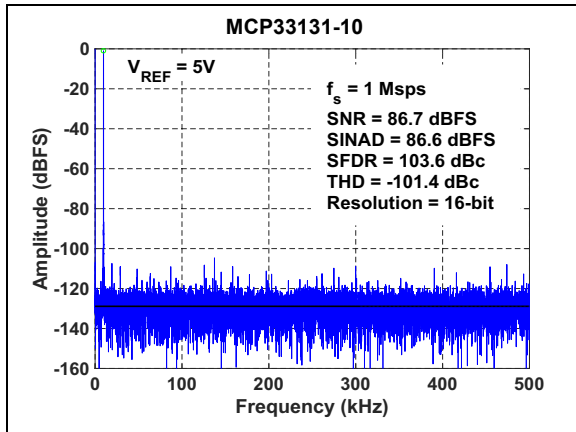

**FIGURE 2-8:** FFT for 10 kHz Input Signal:  $f_S = 1\text{ MspS}$ ,  $V_{IN} = -1\text{ dBFS}$ ,  $V_{REF} = 5\text{V}$ .

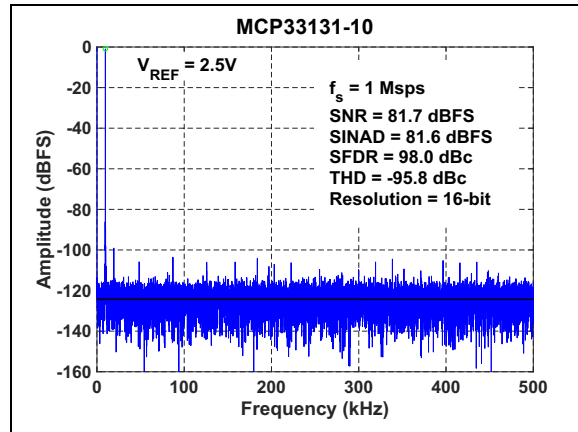

**FIGURE 2-11:** FFT for 10 kHz Input Signal:  $f_S = 1\text{ MspS}$ ,  $V_{IN} = -1\text{ dBFS}$ ,  $V_{REF} = 2.5\text{V}$ .

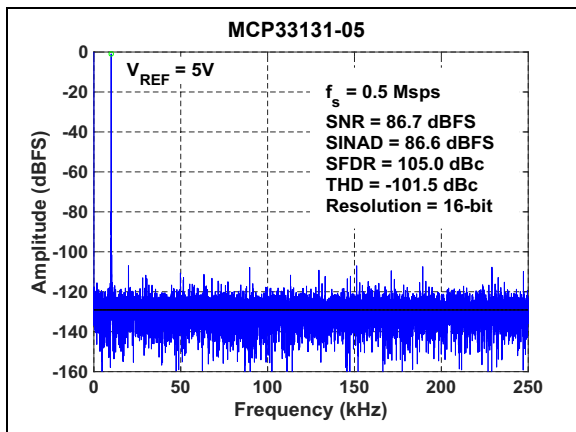

**FIGURE 2-9:** FFT for 10 kHz Input Signal:  $f_S = 500\text{ kSPS}$ ,  $V_{IN} = -1\text{ dBFS}$ ,  $V_{REF} = 5\text{V}$ .

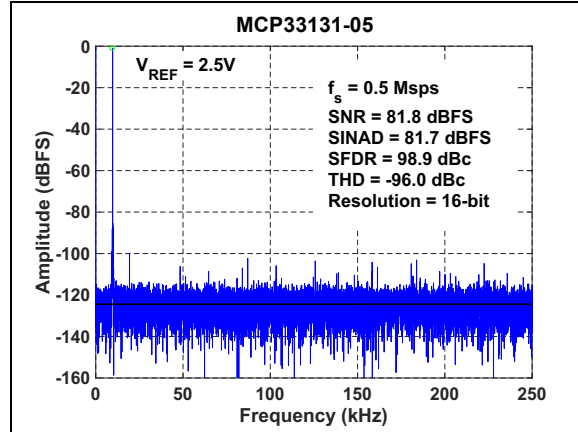

**FIGURE 2-12:** FFT for 10 kHz Input Signal:  $f_S = 500\text{ kSPS}$ ,  $V_{IN} = -1\text{ dBFS}$ ,  $V_{REF} = 2.5\text{V}$ .

# MCP33131/MCP33121/MCP33111-XX

**Note:** Unless otherwise specified, all parameters apply for  $T_A = +25^\circ\text{C}$ ,  $V_{DD} = 1.8\text{V}$ ,  $DV_{IO} = 3.3\text{V}$ ,  $V_{REF} = 5\text{V}$ ,  $\text{GND} = 0\text{V}$ , Differential Analog Input ( $V_{IN}$ ) = -1 dBFS,  $f_{IN} = 10\text{ kHz}$ ,  $C_{LOAD\_SDO} = 20\text{ pF}$ .  
**MCP33131-10:** Sample Rate ( $f_S$ ) = 1 Msp/s, SPI Clock Input (SCLK) = 60 MHz.  
**MCP33131-05:** Sample Rate ( $f_S$ ) = 500 kSPS, SPI Clock Input (SCLK) = 30 MHz.

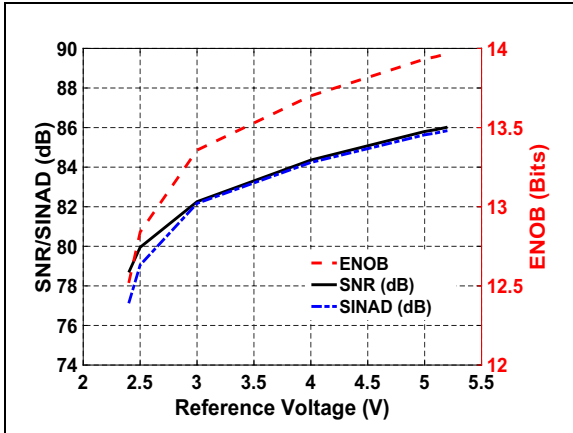

**FIGURE 2-13:** SNR/SINAD/ENOB vs.  $V_{REF}$

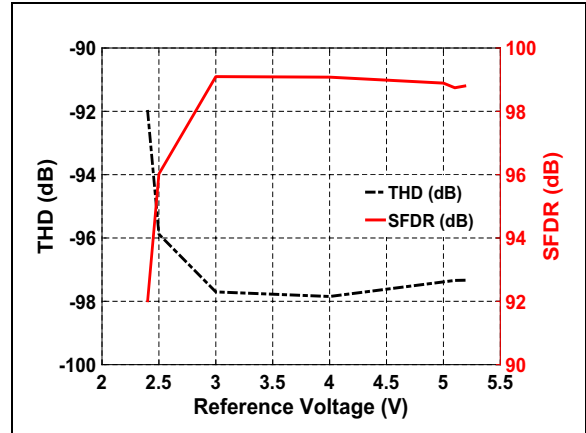

**FIGURE 2-16:** SFDR/THD vs.  $V_{REF}$

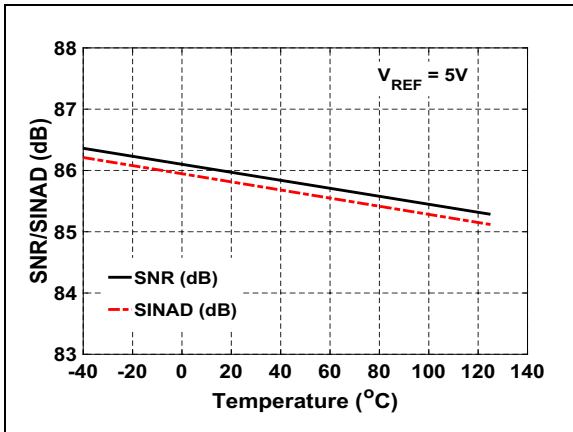

**FIGURE 2-14:** SNR/SINAD vs. Temperature:  $V_{REF} = 5\text{V}$ .

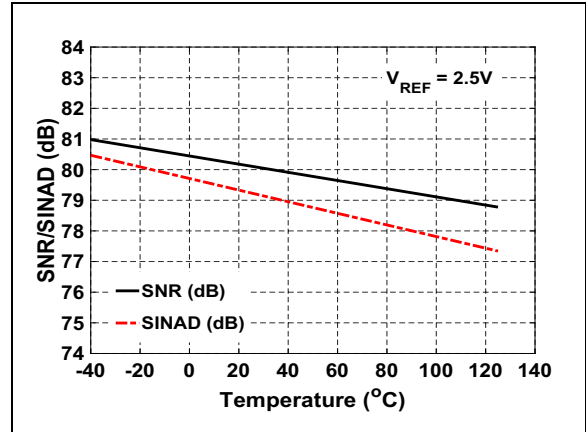

**FIGURE 2-17:** SNR/SINAD vs. Temperature:  $V_{REF} = 2.5\text{V}$ .

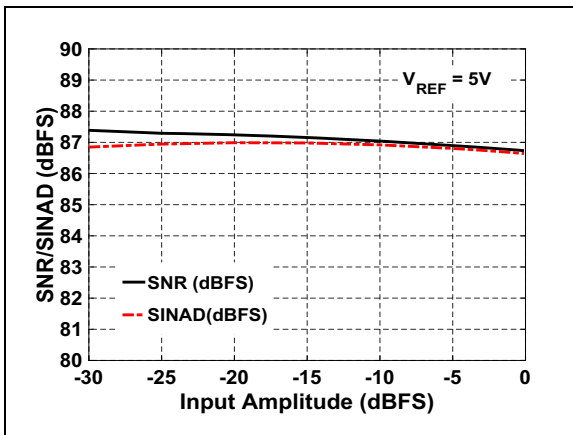

**FIGURE 2-15:** SNR/SINAD vs. Input Amplitude:  $F_{IN} = 10\text{ kHz}$ .

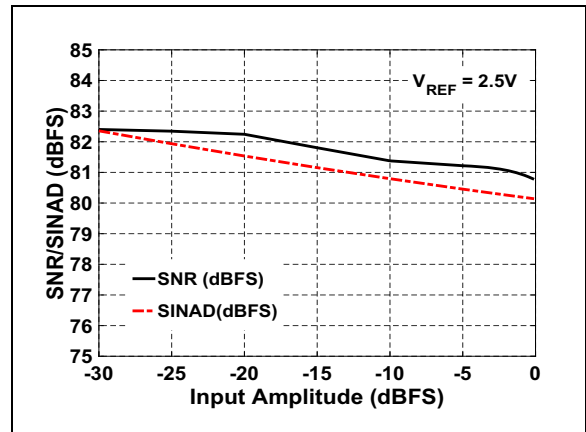

**FIGURE 2-18:** SNR/SINAD vs. Input Amplitude:  $F_{IN} = 10\text{ kHz}$ .

# MCP33131/MCP33121/MCP33111-XX

**Note:** Unless otherwise specified, all parameters apply for  $T_A = +25^\circ\text{C}$ ,  $AV_{DD} = 1.8\text{V}$ ,  $DV_{IO} = 3.3\text{V}$ ,  $V_{REF} = 5\text{V}$ ,  $\text{GND} = 0\text{V}$ , Differential Analog Input ( $V_{IN}$ ) = -1 dBFS,  $f_{IN} = 10\text{ kHz}$ ,  $C_{LOAD\_SDO} = 20\text{ pF}$ .  
**MCP33131-10:** Sample Rate ( $f_S$ ) = 1 Msps, SPI Clock Input (SCLK) = 60 MHz.  
**MCP33131-05:** Sample Rate ( $f_S$ ) = 500 kSPS, SPI Clock Input (SCLK) = 30 MHz.

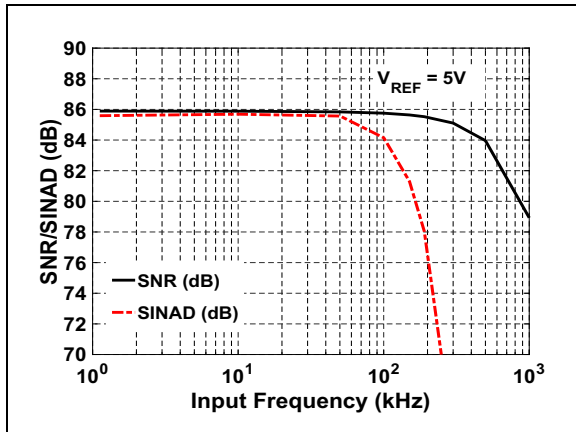

**FIGURE 2-19:** SNR/SINAD vs. Input Frequency:  $V_{IN} = -1\text{ dBFS}$ .

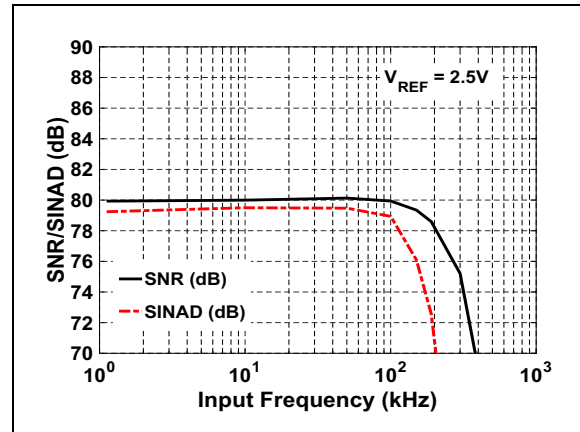

**FIGURE 2-22:** SNR/SINAD vs. Input Frequency:  $V_{IN} = -1\text{ dBFS}$ .

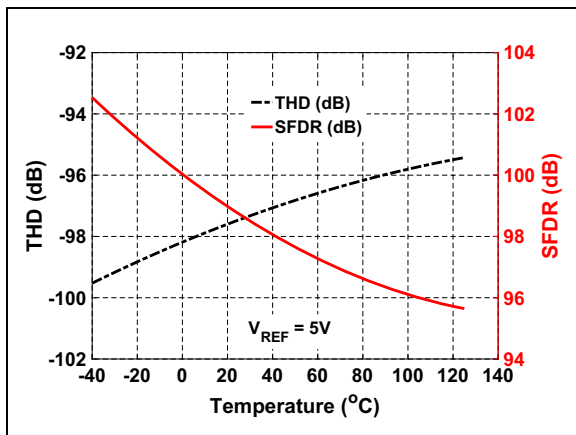

**FIGURE 2-20:** THD/SFDR vs. Temperature:  $V_{REF} = 5\text{V}$ .

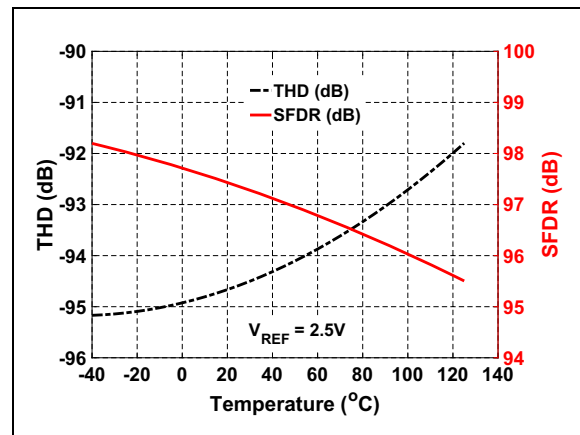

**FIGURE 2-23:** THD/SFDR vs. Temperature:  $V_{REF} = 2.5\text{V}$ .

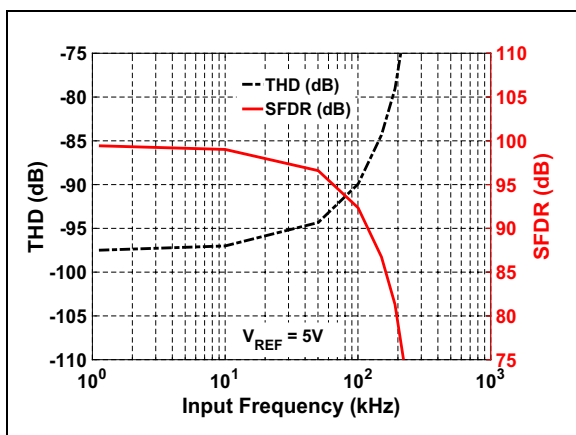

**FIGURE 2-21:** THD/SFDR vs. Input Frequency:  $V_{REF} = 5\text{V}$ .

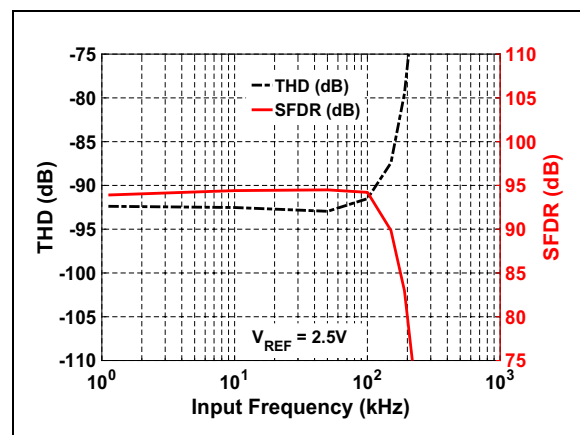

**FIGURE 2-24:** THD/SFDR vs. Input Frequency:  $V_{REF} = 2.5\text{V}$ .

# MCP33131/MCP33121/MCP33111-XX

**Note:** Unless otherwise specified, all parameters apply for  $T_A = +25^\circ\text{C}$ ,  $V_{DD} = 1.8\text{V}$ ,  $DV_{IO} = 3.3\text{V}$ ,  $V_{REF} = 5\text{V}$ ,  $\text{GND} = 0\text{V}$ , Differential Analog Input ( $V_{IN}$ ) = -1 dBFS,  $f_{IN} = 10\text{ kHz}$ ,  $C_{LOAD\_SDO} = 20\text{ pF}$ .  
**MCP33131-10:** Sample Rate ( $f_S$ ) = 1 Msps, SPI Clock Input (SCLK) = 60 MHz.  
**MCP33131-05:** Sample Rate ( $f_S$ ) = 500 kSPS, SPI Clock Input (SCLK) = 30 MHz.

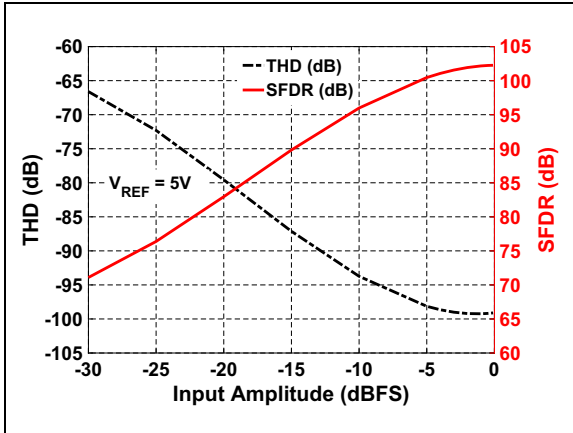

**FIGURE 2-25:** THD/SFDR vs. Input Amplitude:  $V_{REF} = 5\text{V}$ .

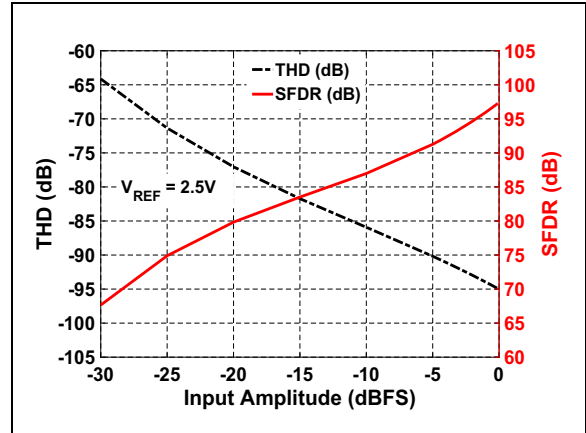

**FIGURE 2-28:** THD/SFDR vs. Input Amplitude:  $V_{REF} = 2.5\text{V}$ .

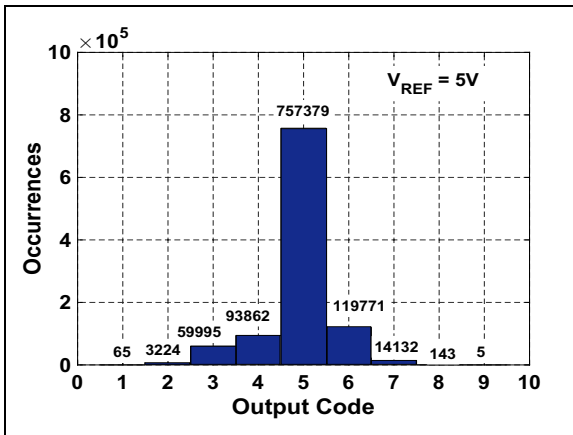

**FIGURE 2-26:** Shorted Input Histogram:  $V_{REF} = 5\text{V}$ .

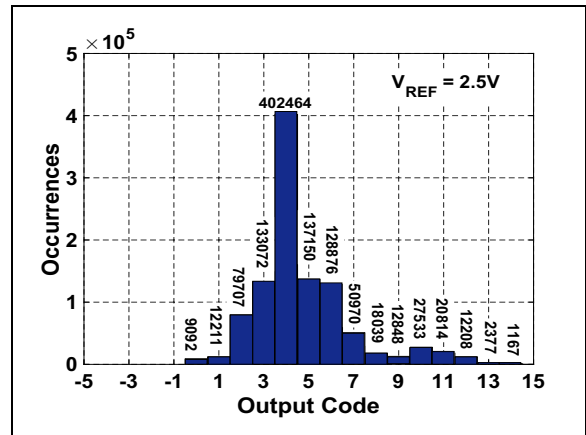

**FIGURE 2-29:** Shorted Input Histogram:  $V_{REF} = 2.5\text{V}$ .

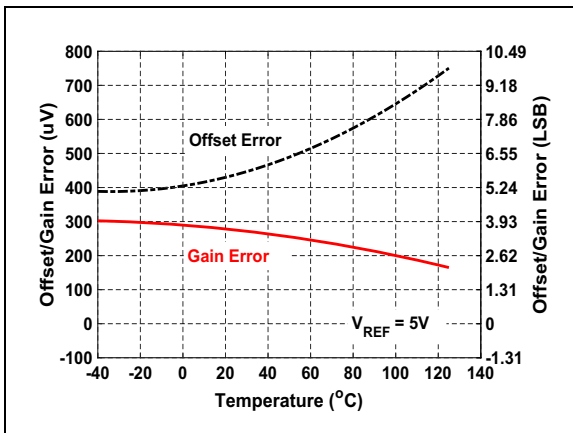

**FIGURE 2-27:** Offset and Gain Error vs. Temperature:  $V_{REF} = 5\text{V}$ .

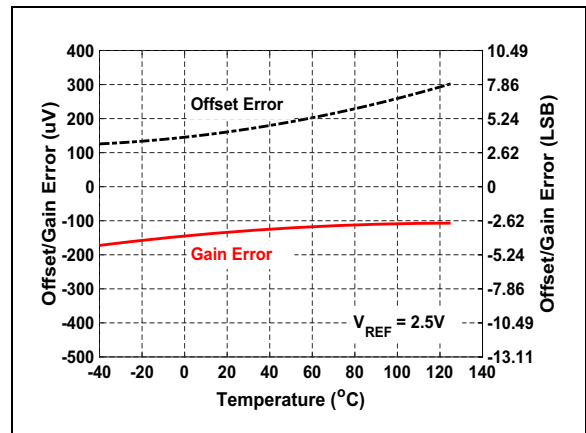

**FIGURE 2-30:** Offset and Gain Error vs. Temperature:  $V_{REF} = 2.5\text{V}$ .

# MCP33131/MCP33121/MCP33111-XX

**Note:** Unless otherwise specified, all parameters apply for  $T_A = +25^\circ\text{C}$ ,  $AV_{DD} = 1.8\text{V}$ ,  $DV_{IO} = 3.3\text{V}$ ,  $V_{REF} = 5\text{V}$ ,  $\text{GND} = 0\text{V}$ , Differential Analog Input ( $V_{IN}$ ) = -1 dBFS,  $f_{IN} = 10\text{ kHz}$ ,  $C_{LOAD\_SDO} = 20\text{ pF}$ .  
**MCP33131-10:** Sample Rate ( $f_S$ ) = 1 Msps, SPI Clock Input (SCLK) = 60 MHz.  
**MCP33131-05:** Sample Rate ( $f_S$ ) = 500 kSPS, SPI Clock Input (SCLK) = 30 MHz.

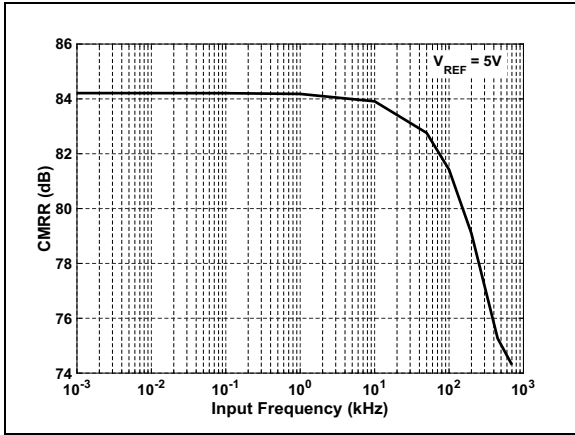

**FIGURE 2-31:** CMRR vs. Input Frequency:  $V_{REF} = 5\text{V}$ .

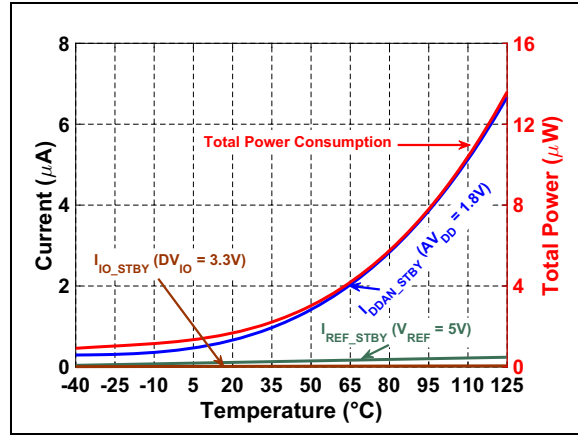

**FIGURE 2-34:** Power Consumption vs. Temperature During Shutdown.

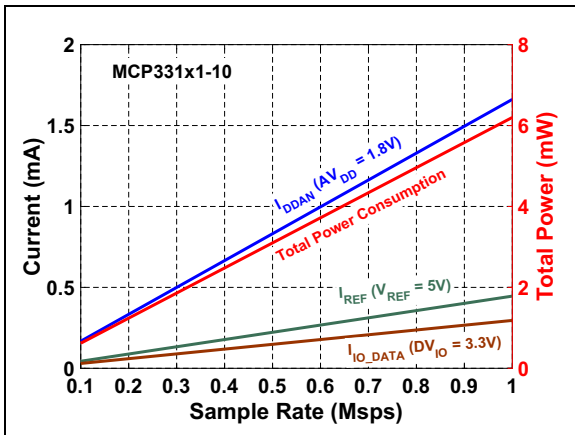

**FIGURE 2-32:** Power Consumption vs. Sample Rate:  $C_{LOAD\_SDO} = 20\text{ pF}$ .

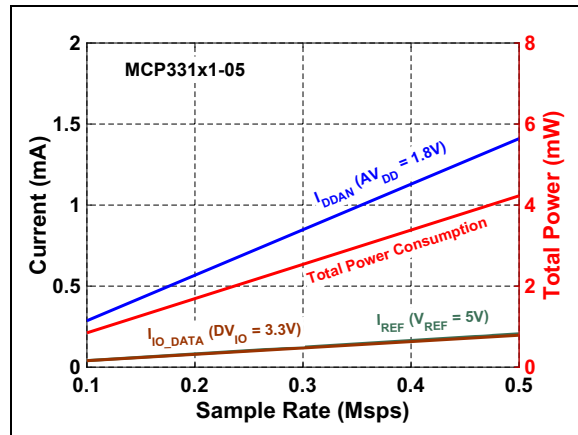

**FIGURE 2-35:** Power Consumption vs. Sample Rate:  $C_{LOAD\_SDO} = 20\text{ pF}$ .

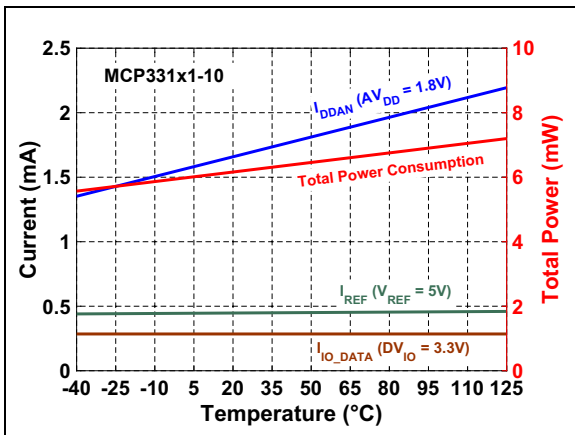

**FIGURE 2-33:** Power Consumption vs. Temperature:  $C_{LOAD\_SDO} = 20\text{ pF}$ .

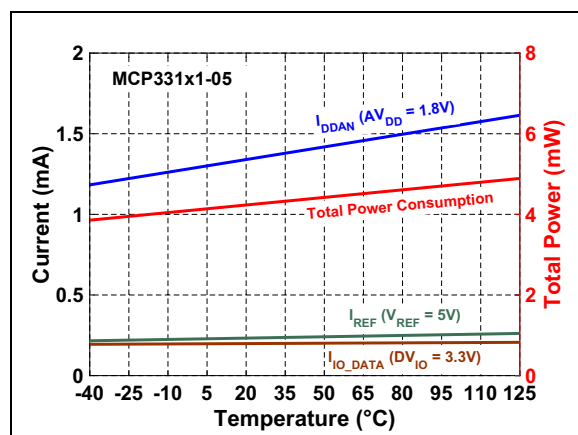

**FIGURE 2-36:** Power Consumption vs. Temperature:  $C_{LOAD\_SDO} = 20\text{ pF}$ .



# MCP33131/MCP33121/MCP33111-XX

## 3.0 TYPICAL PERFORMANCE CURVES FOR 14-BIT DEVICES (MCP33121-XX)

**Note:** The graphs and tables provided following this note are a statistical summary based on a limited number of samples and are provided for informational purposes only. The performance characteristics listed herein are not tested or guaranteed. In some graphs or tables, the data presented may be outside the specified operating range (e.g., outside specified power supply range) and therefore outside the warranted range.

**Note:** Unless otherwise specified, all parameters apply for  $T_A = +25^\circ\text{C}$ ,  $AV_{DD} = 1.8\text{V}$ ,  $DV_{IO} = 3.3\text{V}$ ,  $V_{REF} = 5\text{V}$ ,  $\text{GND} = 0\text{V}$ , Differential Analog Input ( $V_{IN}$ ) = -1 dBFS,  $f_{IN} = 10\text{ kHz}$ ,  $C_{LOAD\_SDO} = 20\text{ pF}$ .  
**MCP33121-10:** Sample Rate ( $f_S$ ) = 1 MspS, SPI Clock Input (SCLK) = 60 MHz.  
**MCP33121-05:** Sample Rate ( $f_S$ ) = 500 kSPS, SPI Clock Input (SCLK) = 30 MHz.

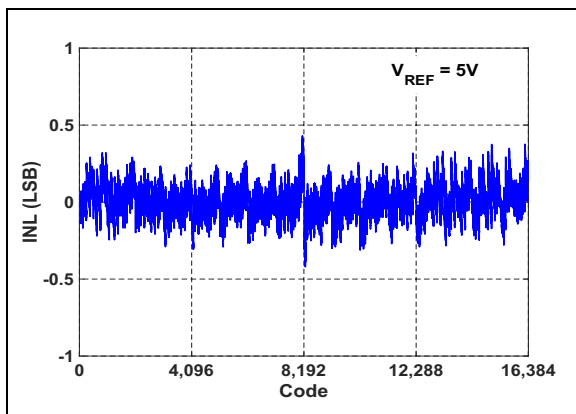

FIGURE 3-1: INL vs. Output Code.

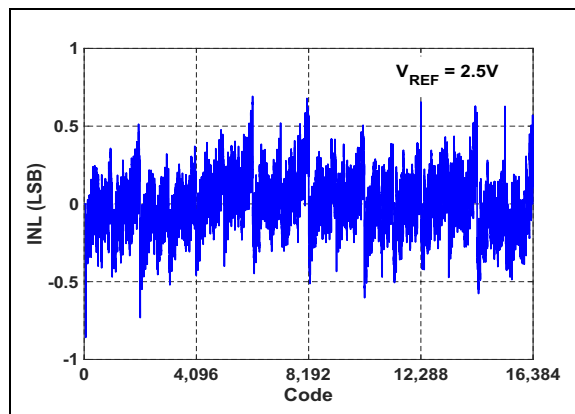

FIGURE 3-4: INL vs. Output Code.

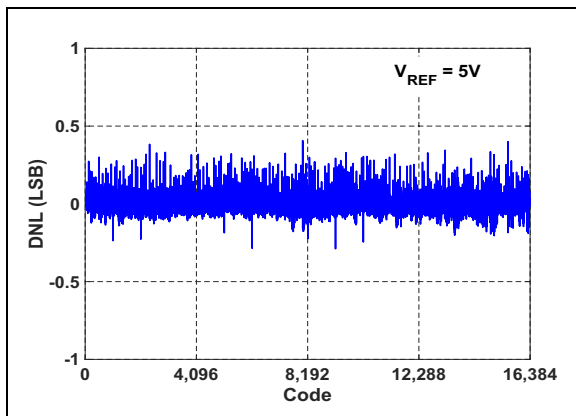

FIGURE 3-2: DNL vs. Output Code.

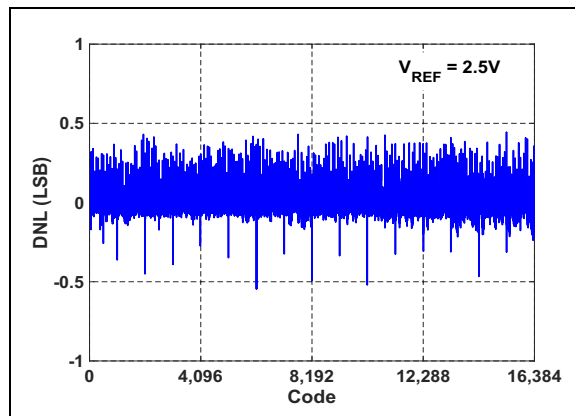

FIGURE 3-5: DNL vs. Output Code.

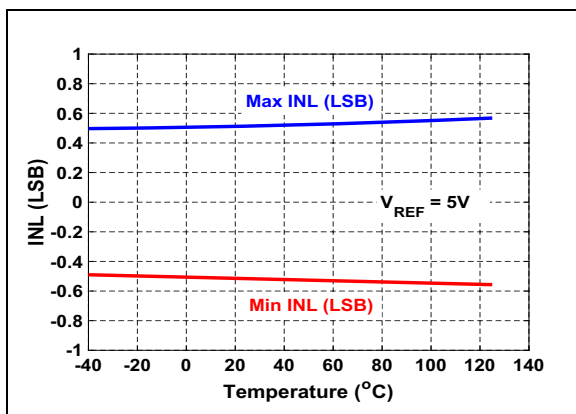

FIGURE 3-3: INL vs. Temperature.

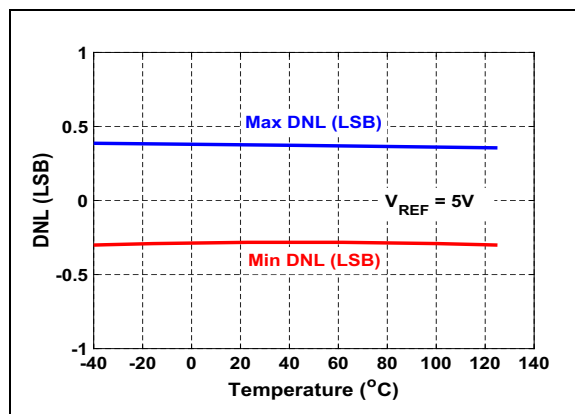
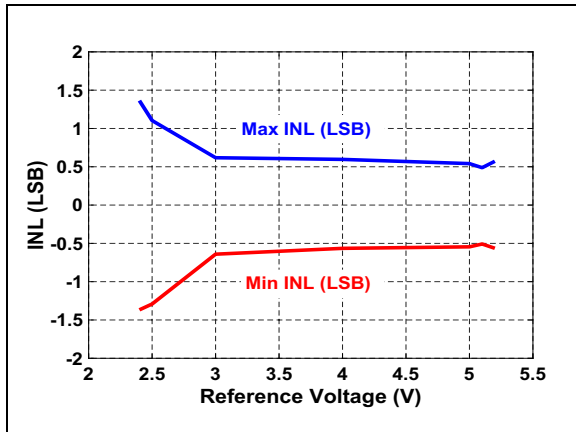

FIGURE 3-6: DNL vs. Temperature.

# MCP33131/MCP33121/MCP33111-XX

**Note:** Unless otherwise specified, all parameters apply for  $T_A = +25^\circ\text{C}$ ,  $AV_{DD} = 1.8\text{V}$ ,  $DV_{IO} = 3.3\text{V}$ ,  $V_{REF} = 5\text{V}$ ,  $\text{GND} = 0\text{V}$ , Differential Analog Input ( $V_{IN}$ ) = -1 dBFS,  $f_{IN} = 10\text{ kHz}$ ,  $C_{LOAD\_SDO} = 20\text{ pF}$ .  
**MCP33121-10:** Sample Rate ( $f_s$ ) = 1 Msps, SPI Clock Input (SCLK) = 60 MHz.  
**MCP33121-05:** Sample Rate ( $f_s$ ) = 500 kSPS, SPI Clock Input (SCLK) = 30 MHz.



**FIGURE 3-7:** INL vs. Reference Voltage.

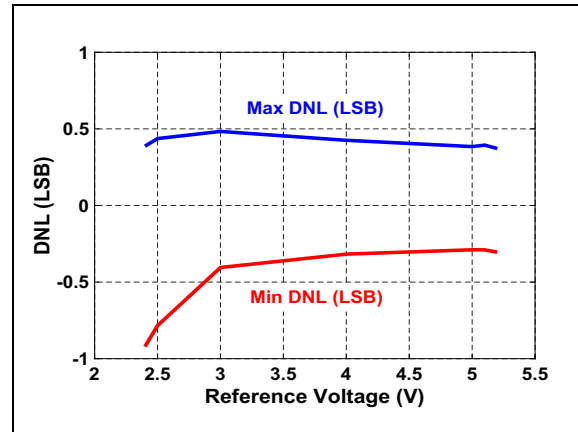

**FIGURE 3-10:** DNL vs. Reference Voltage.

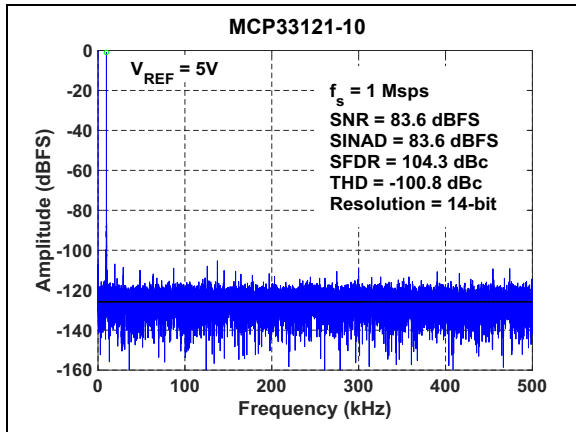

**FIGURE 3-8:** FFT for 10 kHz Input Signal:  $f_s = 1\text{ Msps}$ ,  $V_{IN} = -1\text{ dBFS}$ ,  $V_{REF} = 5\text{V}$ .

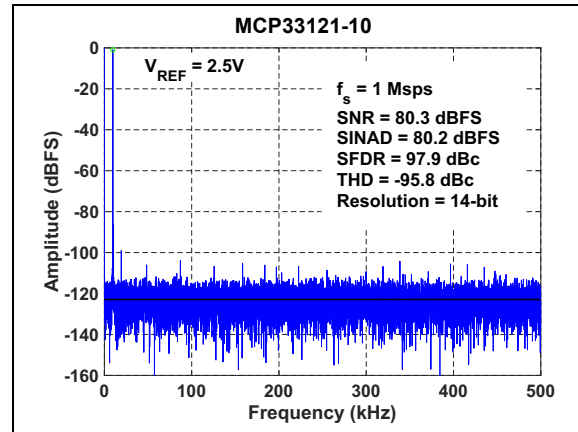

**FIGURE 3-11:** FFT for 10 kHz Input Signal:  $f_s = 1\text{ Msps}$ ,  $V_{IN} = -1\text{ dBFS}$ ,  $V_{REF} = 2.5\text{V}$ .

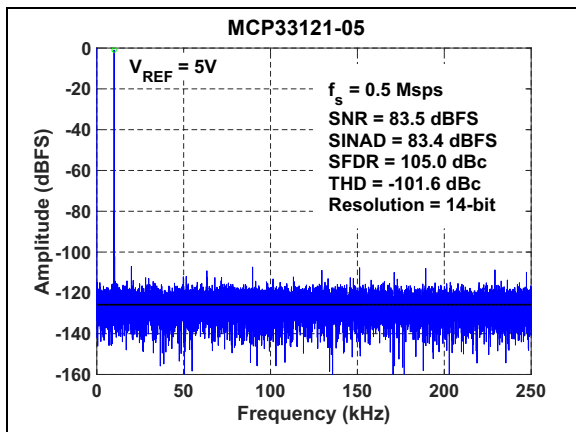

**FIGURE 3-9:** FFT for 10 kHz Input Signal:  $f_s = 500\text{ kSPS}$ ,  $V_{IN} = -1\text{ dBFS}$ ,  $V_{REF} = 5\text{V}$ .

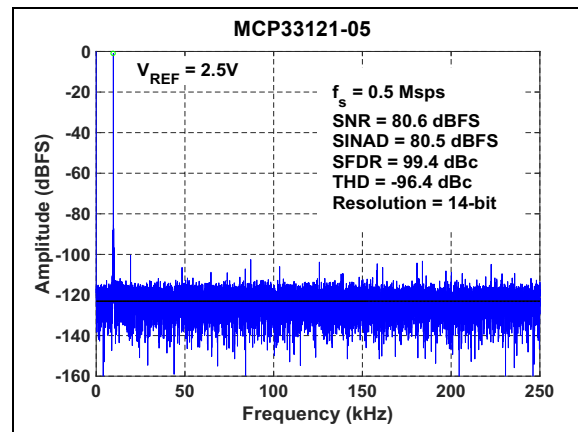

**FIGURE 3-12:** FFT for 10 kHz Input Signal:  $f_s = 500\text{ kSPS}$ ,  $V_{IN} = -1\text{ dBFS}$ ,  $V_{REF} = 2.5\text{V}$ .

# MCP33131/MCP33121/MCP33111-XX

**Note:** Unless otherwise specified, all parameters apply for  $T_A = +25^\circ\text{C}$ ,  $V_{DD} = 1.8\text{V}$ ,  $DV_{IO} = 3.3\text{V}$ ,  $V_{REF} = 5\text{V}$ ,  $\text{GND} = 0\text{V}$ , Differential Analog Input ( $V_{IN}$ ) = -1 dBFS,  $f_{IN} = 10\text{ kHz}$ ,  $C_{LOAD\_SDO} = 20\text{ pF}$ .  
**MCP33121-10:** Sample Rate ( $f_S$ ) = 1 Msps, SPI Clock Input (SCLK) = 60 MHz.  
**MCP33121-05:** Sample Rate ( $f_S$ ) = 500 kSPS, SPI Clock Input (SCLK) = 30 MHz.

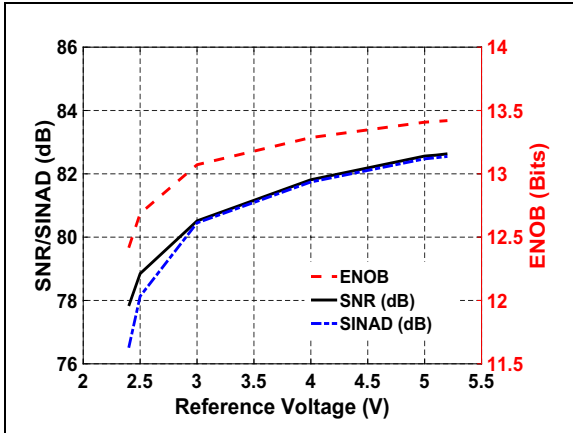

**FIGURE 3-13:** SNR/SINAD/ENOB vs.  $V_{REF}$ .

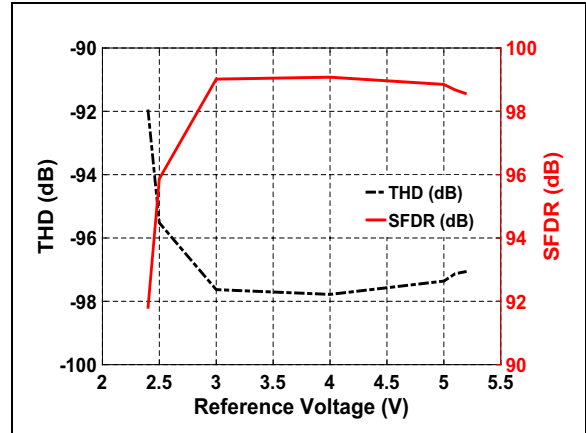

**FIGURE 3-16:** SFDR/THD vs.  $V_{REF}$ .

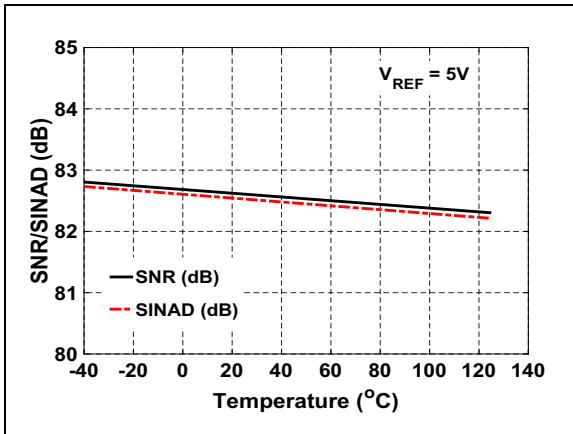

**FIGURE 3-14:** SNR/SINAD vs. Temperature:  $V_{REF} = 5\text{V}$ .

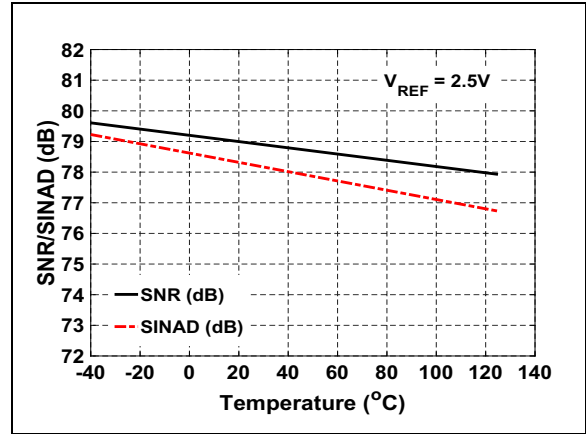

**FIGURE 3-17:** SNR/SINAD vs. Temperature:  $V_{REF} = 2.5\text{V}$ .

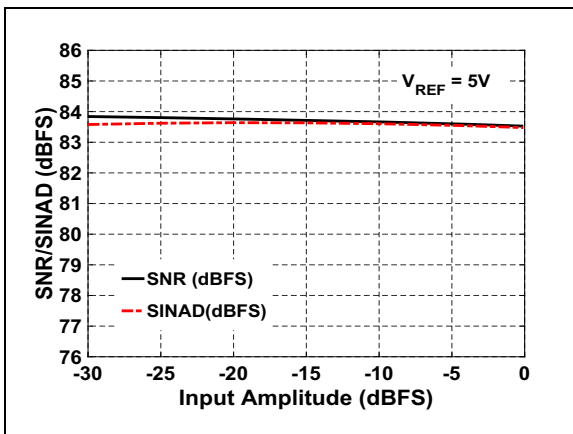

**FIGURE 3-15:** SNR/SINAD vs. Input Amplitude:  $f_{IN} = 10\text{ kHz}$ .

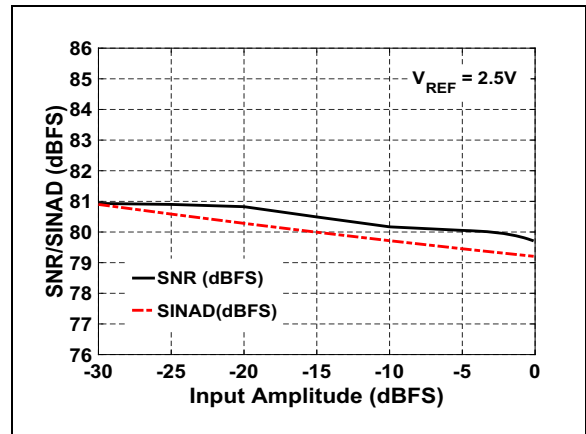

**FIGURE 3-18:** SNR/SINAD vs. Input Amplitude:  $f_{IN} = 10\text{ kHz}$ .

# MCP33131/MCP33121/MCP33111-XX

**Note:** Unless otherwise specified, all parameters apply for  $T_A = +25^\circ\text{C}$ ,  $AV_{DD} = 1.8\text{V}$ ,  $DV_{IO} = 3.3\text{V}$ ,  $V_{REF} = 5\text{V}$ ,  $\text{GND} = 0\text{V}$ , Differential Analog Input ( $V_{IN}$ ) = -1 dBFS,  $f_{IN} = 10\text{ kHz}$ ,  $C_{LOAD\_SDO} = 20\text{ pF}$ .  
**MCP33121-10:** Sample Rate ( $f_S$ ) = 1 Msp/s, SPI Clock Input (SCLK) = 60 MHz.  
**MCP33121-05:** Sample Rate ( $f_S$ ) = 500 kSPS, SPI Clock Input (SCLK) = 30 MHz.

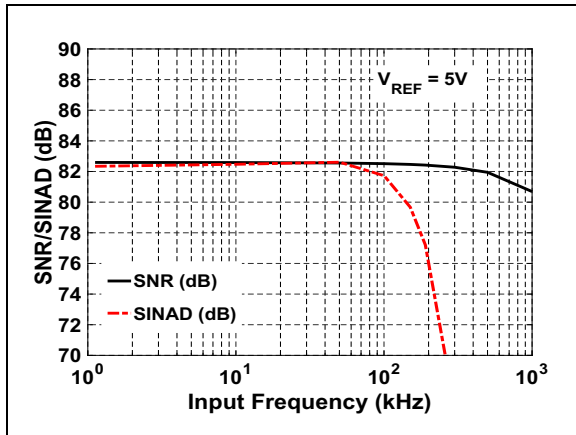

**FIGURE 3-19:** SNR/SINAD vs. Input Frequency:  $V_{IN} = -1\text{ dBFS}$ .

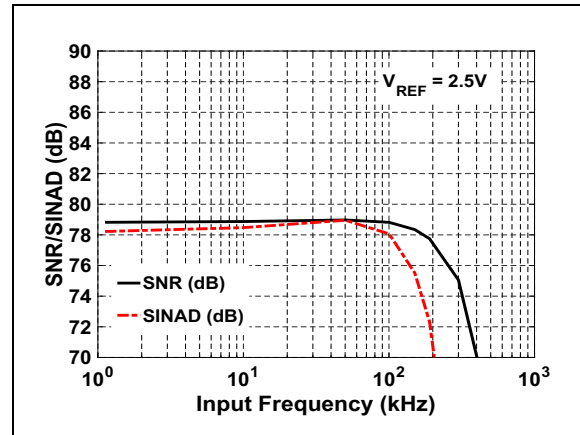

**FIGURE 3-22:** SNR/SINAD vs. Input Frequency:  $V_{IN} = -1\text{ dBFS}$ .

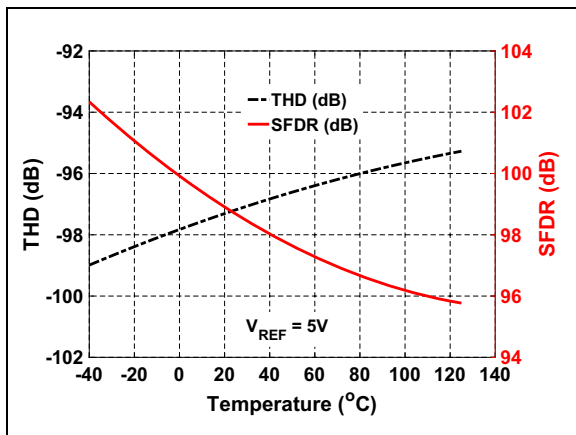

**FIGURE 3-20:** THD/SFDR vs. Temperature:  $V_{REF} = 5\text{V}$ .

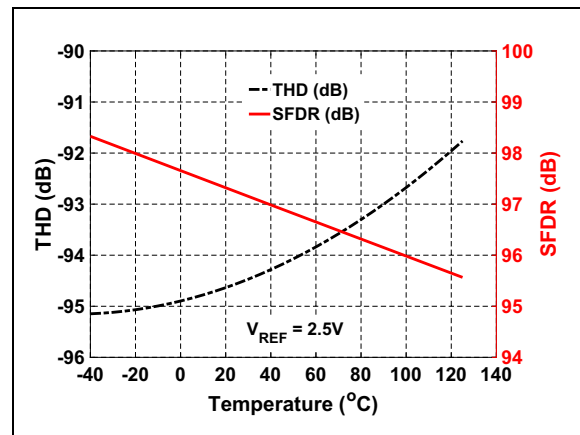

**FIGURE 3-23:** THD/SFDR vs. Temperature:  $V_{REF} = 2.5\text{V}$ .

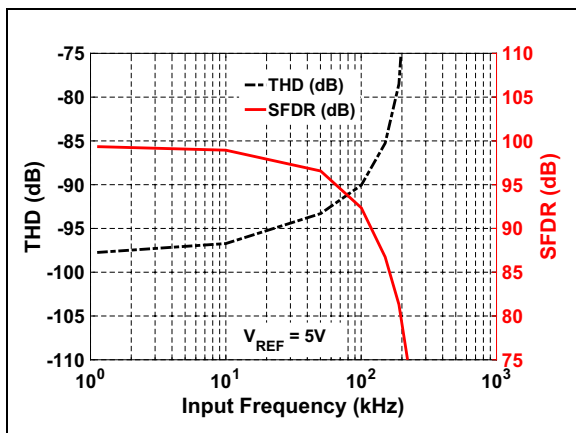

**FIGURE 3-21:** THD/SFDR vs. Input Frequency:  $V_{REF} = 5\text{V}$ .

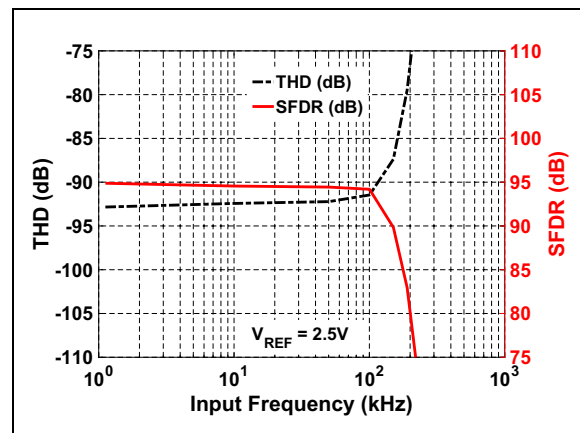

**FIGURE 3-24:** THD/SFDR vs. Input Frequency:  $V_{REF} = 2.5\text{V}$ .

# MCP33131/MCP33121/MCP33111-XX

**Note:** Unless otherwise specified, all parameters apply for  $T_A = +25^\circ\text{C}$ ,  $AV_{DD} = 1.8\text{V}$ ,  $DV_{IO} = 3.3\text{V}$ ,  $V_{REF} = 5\text{V}$ ,  $\text{GND} = 0\text{V}$ , Differential Analog Input ( $V_{IN}$ ) = -1 dBFS,  $f_{IN} = 10\text{ kHz}$ ,  $C_{LOAD\_SDO} = 20\text{ pF}$ .  
**MCP33121-10:** Sample Rate ( $f_S$ ) = 1 Msp/s, SPI Clock Input (SCLK) = 60 MHz.  
**MCP33121-05:** Sample Rate ( $f_S$ ) = 500 kSPS, SPI Clock Input (SCLK) = 30 MHz.

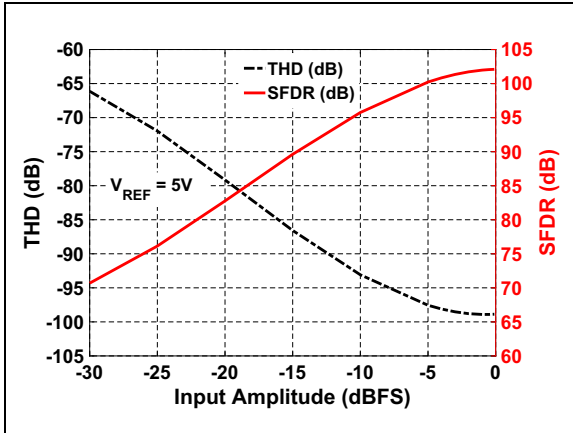

**FIGURE 3-25:** THD/SFDR vs. Input Amplitude:  $V_{REF} = 5\text{V}$ .

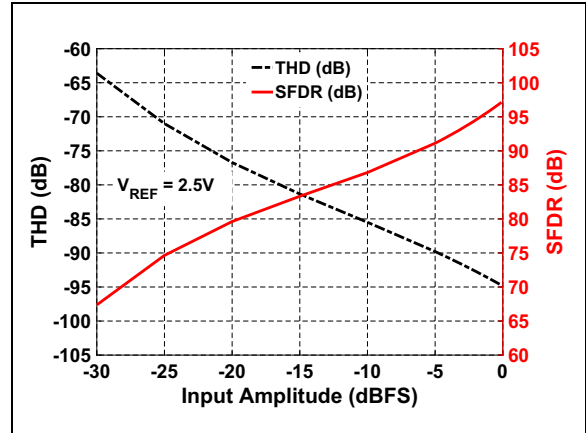

**FIGURE 3-28:** THD/SFDR vs. Input Amplitude:  $V_{REF} = 2.5\text{V}$ .

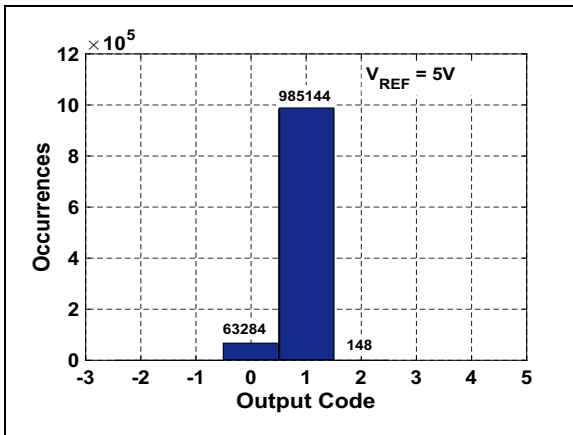

**FIGURE 3-26:** Shorted Input Histogram:  $V_{REF} = 5\text{V}$ .

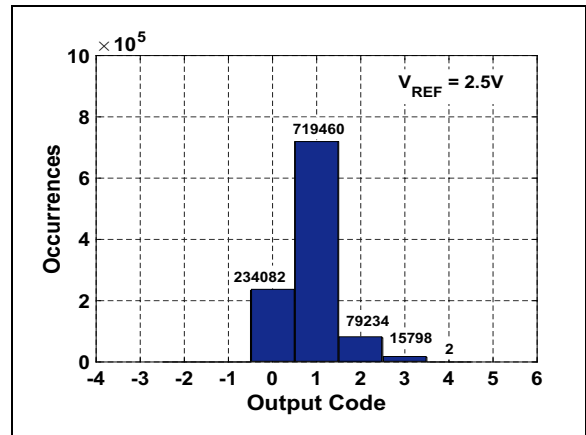

**FIGURE 3-29:** Shorted Input Histogram:  $V_{REF} = 2.5\text{V}$ .

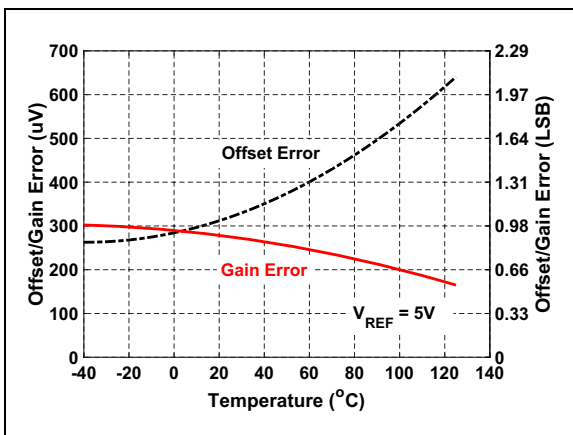

**FIGURE 3-27:** Offset and Gain Error vs. Temperature:  $V_{REF} = 5\text{V}$ .

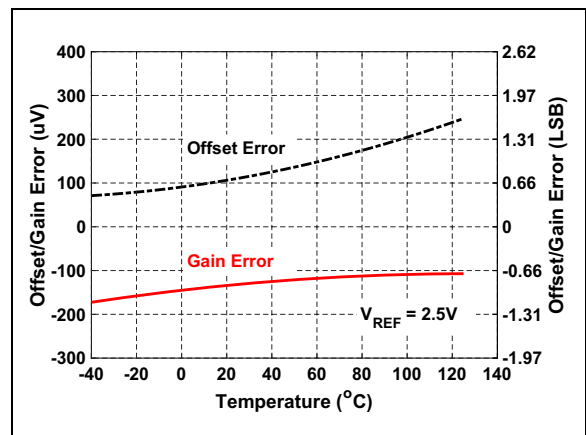

**FIGURE 3-30:** Offset and Gain Error vs. Temperature:  $V_{REF} = 2.5\text{V}$ .

# MCP33131/MCP33121/MCP33111-XX

**Note:** Unless otherwise specified, all parameters apply for  $T_A = +25^\circ\text{C}$ ,  $AV_{DD} = 1.8\text{V}$ ,  $DV_{IO} = 3.3\text{V}$ ,  $V_{REF} = 5\text{V}$ ,  $\text{GND} = 0\text{V}$ , Differential Analog Input ( $V_{IN}$ ) = -1 dBFS,  $f_{IN} = 10\text{ kHz}$ ,  $C_{LOAD\_SDO} = 20\text{ pF}$ .  
**MCP33121-10:** Sample Rate ( $f_S$ ) = 1 Msps, SPI Clock Input (SCLK) = 60 MHz.  
**MCP33121-05:** Sample Rate ( $f_S$ ) = 500 kSPS, SPI Clock Input (SCLK) = 30 MHz.

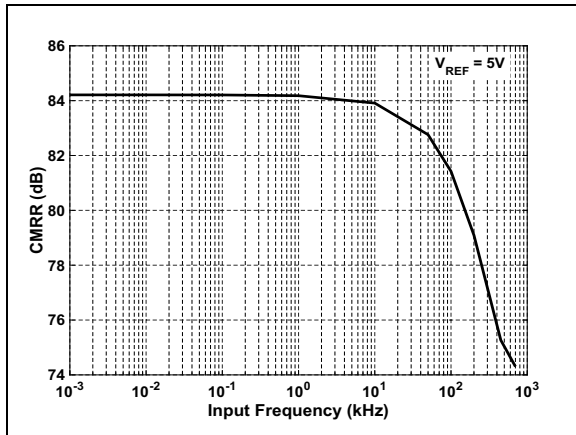

**FIGURE 3-31:** CMRR vs. Input Frequency:  $V_{REF} = 5\text{V}$ .

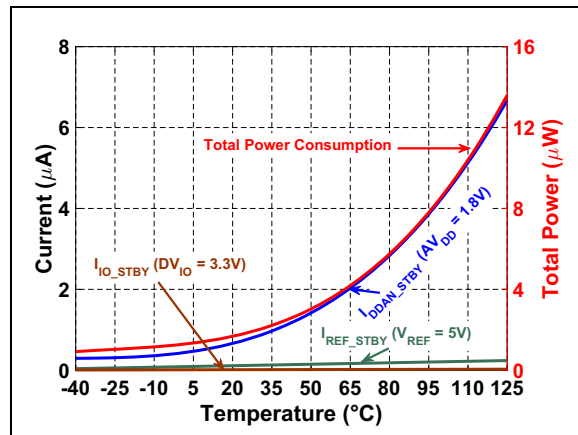

**FIGURE 3-34:** Power Consumption vs. Temperature During Shutdown.

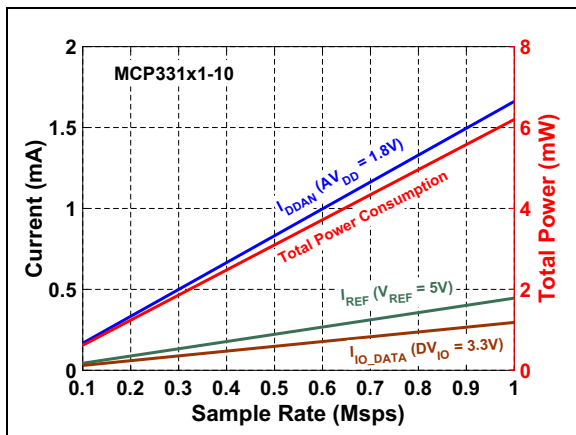

**FIGURE 3-32:** Power Consumption vs. Sample Rate:  $C_{LOAD\_SDO} = 20\text{ pF}$ .

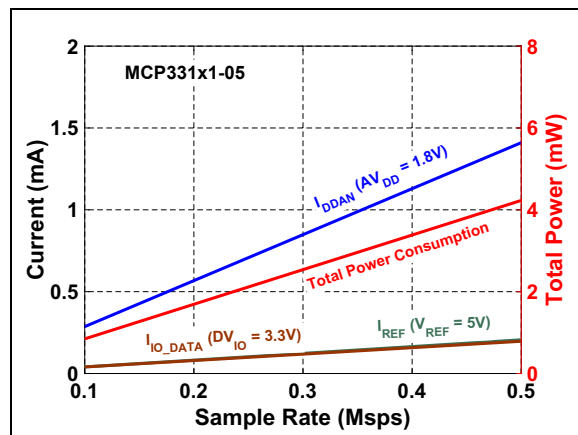

**FIGURE 3-35:** Power Consumption vs. Sample Rate:  $C_{LOAD\_SDO} = 20\text{ pF}$ .

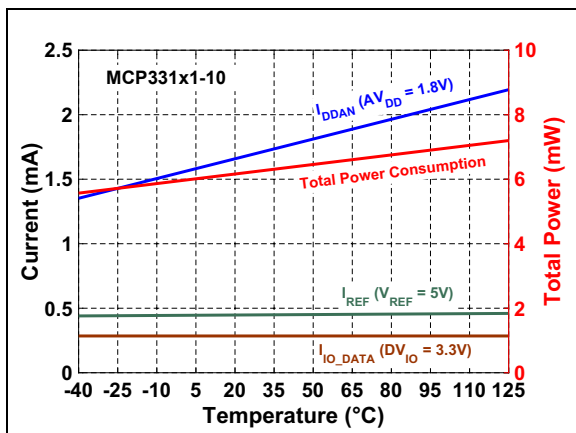

**FIGURE 3-33:** Power Consumption vs. Temperature:  $C_{LOAD\_SDO} = 20\text{ pF}$ .

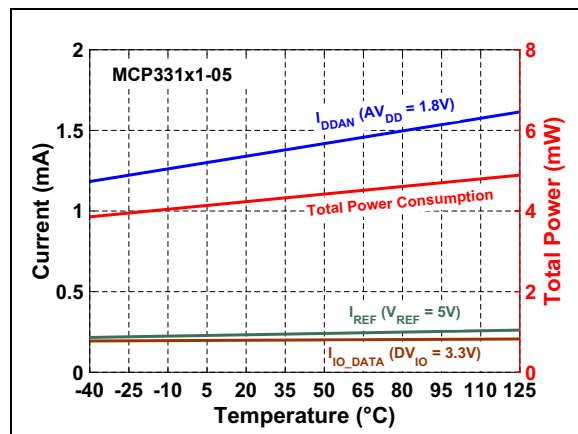

**FIGURE 3-36:** Power Consumption vs. Temperature.

# MCP33131/MCP33121/MCP33111-XX

## 4.0 TYPICAL PERFORMANCE CURVES FOR 12-BIT DEVICES (MCP33111-XX)

**Note:** The graphs and tables provided following this note are a statistical summary based on a limited number of samples and are provided for informational purposes only. The performance characteristics listed herein are not tested or guaranteed. In some graphs or tables, the data presented may be outside the specified operating range (e.g., outside specified power supply range) and therefore outside the warranted range.

**Note:** Unless otherwise specified, all parameters apply for  $T_A = +25^\circ\text{C}$ ,  $V_{DD} = 1.8\text{V}$ ,  $DV_{IO} = 3.3\text{V}$ ,  $V_{REF} = 5\text{V}$ ,  $\text{GND} = 0\text{V}$ , Differential Analog Input ( $V_{IN}$ ) = -1 dBFS,  $f_{IN} = 10\text{ kHz}$ ,  $C_{LOAD\_SDO} = 20\text{ pF}$ .  
**MCP33111-10:** Sample Rate ( $f_S$ ) = 1 MspS, SPI Clock Input (SCLK) = 60 MHz.  
**MCP33111-05:** Sample Rate ( $f_S$ ) = 500 kSPS, SPI Clock Input (SCLK) = 30 MHz.

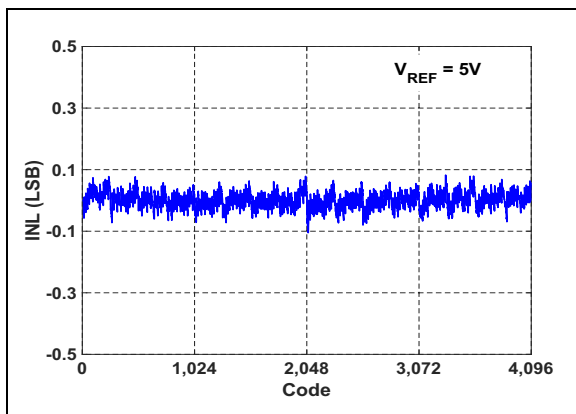

FIGURE 4-1: INL vs. Output Code.

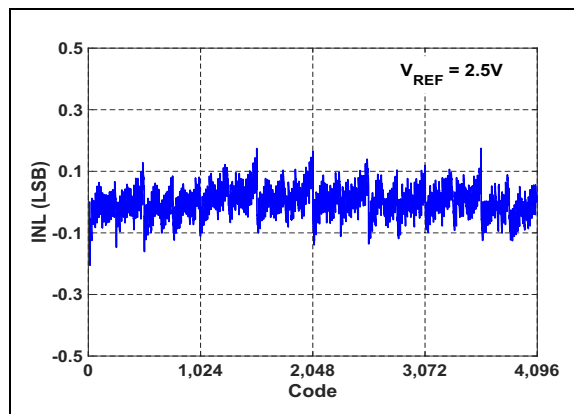

FIGURE 4-4: INL vs. Output Code.

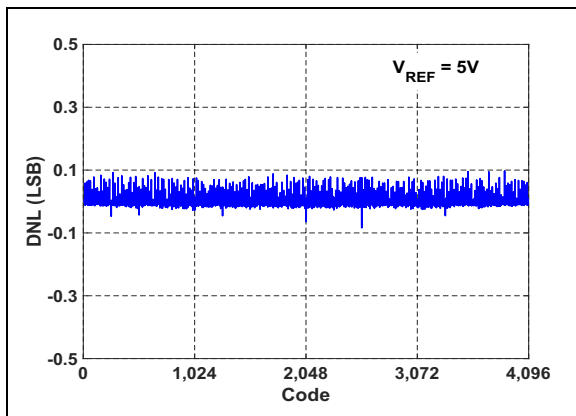

FIGURE 4-2: DNL vs. Output Code.

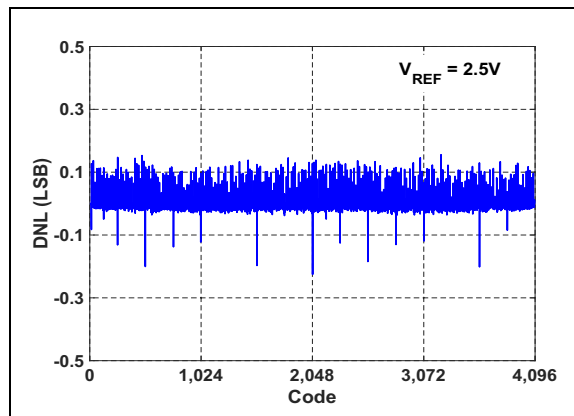

FIGURE 4-5: DNL vs. Output Code.

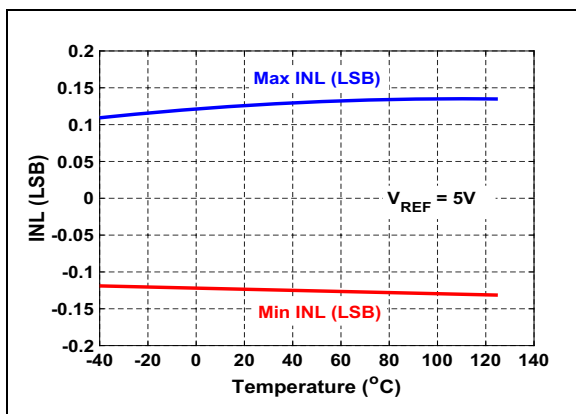

FIGURE 4-3: INL vs. Temperature.

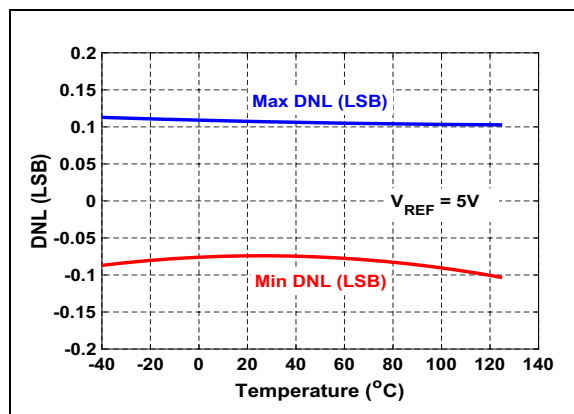
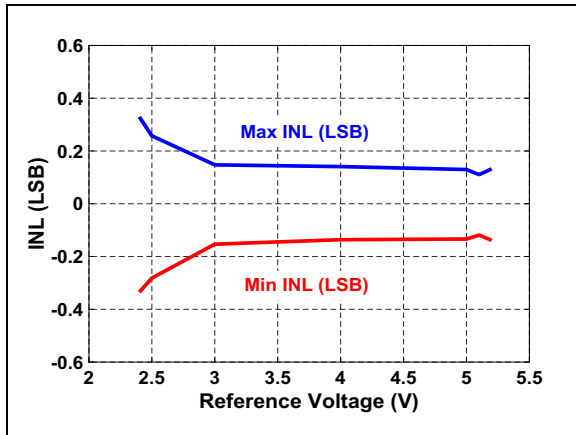

FIGURE 4-6: DNL vs. Temperature.

# MCP33131/MCP33121/MCP33111-XX

**Note:** Unless otherwise specified, all parameters apply for  $T_A = +25^\circ\text{C}$ ,  $AV_{DD} = 1.8\text{V}$ ,  $DV_{IO} = 3.3\text{V}$ ,  $V_{REF} = 5\text{V}$ ,  $\text{GND} = 0\text{V}$ , Differential Analog Input ( $V_{IN}$ ) = -1 dBFS,  $f_{IN} = 10\text{ kHz}$ ,  $C_{LOAD\_SDO} = 20\text{ pF}$ .  
**MCP33111-10:** Sample Rate ( $f_s$ ) = 1 Msps, SPI Clock Input (SCLK) = 60 MHz.  
**MCP33111-05:** Sample Rate ( $f_s$ ) = 500 kSPS, SPI Clock Input (SCLK) = 30 MHz.



**FIGURE 4-7:** INL vs. Reference Voltage.

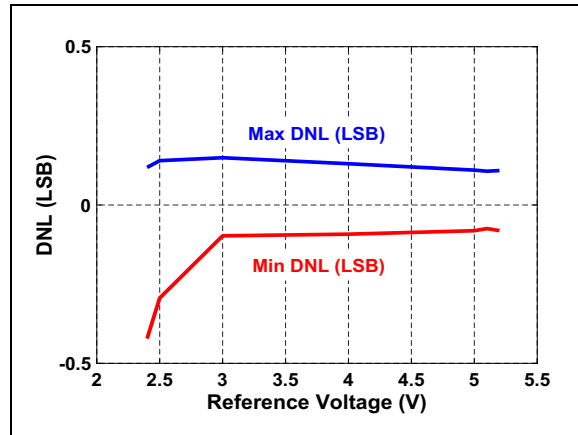

**FIGURE 4-10:** DNL vs. Reference Voltage.

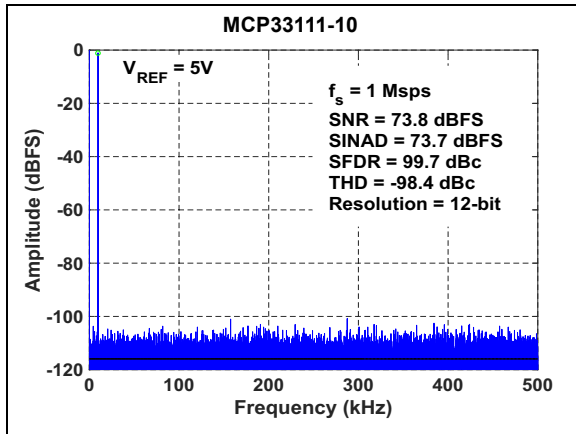

**FIGURE 4-8:** FFT for 10 kHz Input Signal:  $f_s = 1\text{ Msps}$ ,  $V_{IN} = -1\text{ dBFS}$ ,  $V_{REF} = 5\text{V}$ .

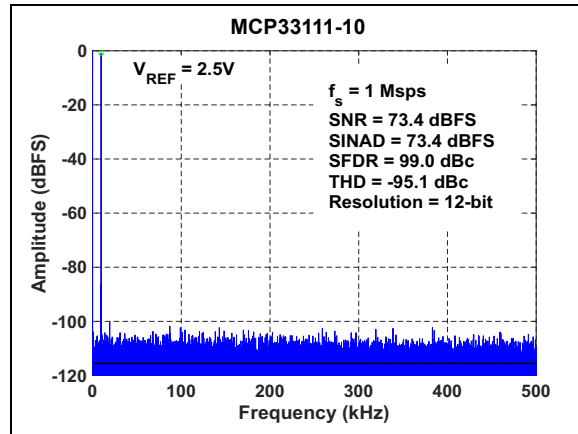

**FIGURE 4-11:** FFT for 10 kHz Input Signal:  $f_s = 1\text{ Msps}$ ,  $V_{IN} = -1\text{ dBFS}$ ,  $V_{REF} = 2.5\text{V}$ .

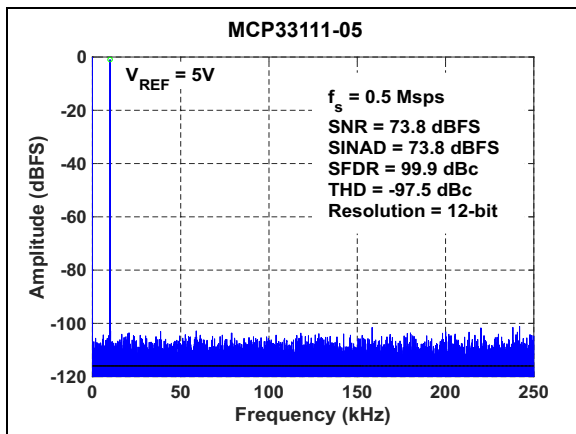

**FIGURE 4-9:** FFT for 10 kHz Input Signal:  $f_s = 500\text{ kSPS}$ ,  $V_{IN} = -1\text{ dBFS}$ ,  $V_{REF} = 5\text{V}$ .

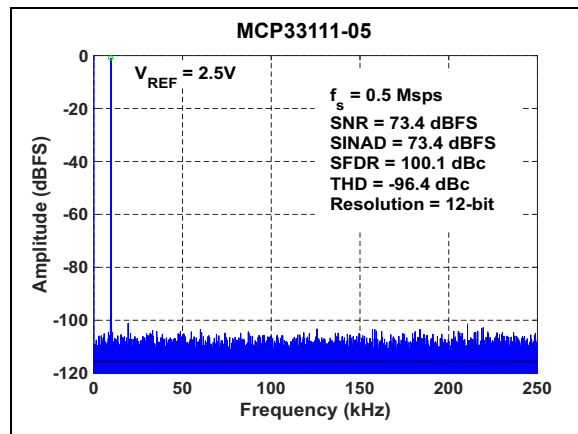
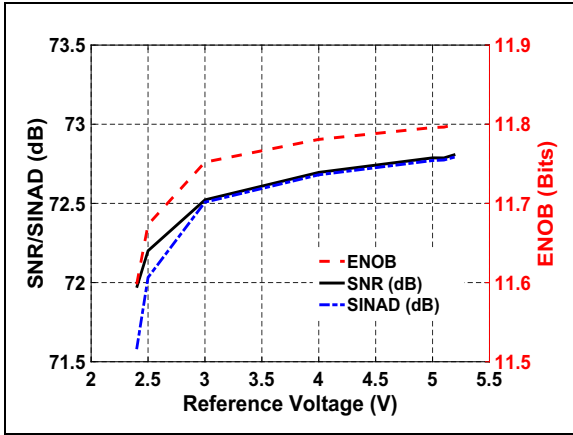

**FIGURE 4-12:** FFT for 10 kHz Input Signal:  $f_s = 500\text{ kSPS}$ ,  $V_{IN} = -1\text{ dBFS}$ ,  $V_{REF} = 2.5\text{V}$ .



# MCP33131/MCP33121/MCP33111-XX

**Note:** Unless otherwise specified, all parameters apply for  $T_A = +25^\circ\text{C}$ ,  $A_{V_{DD}} = 1.8\text{V}$ ,  $DV_{IO} = 3.3\text{V}$ ,  $V_{REF} = 5\text{V}$ ,  $GND = 0\text{V}$ , Differential Analog Input ( $V_{IN}$ ) = -1 dBFS,  $f_{IN} = 10\text{ kHz}$ ,  $C_{LOAD\_SDO} = 20\text{ pF}$ .  
**MCP33111-10:** Sample Rate ( $f_S$ ) = 1 Msps, SPI Clock Input (SCLK) = 60 MHz.  
**MCP33111-05:** Sample Rate ( $f_S$ ) = 500 kSPS, SPI Clock Input (SCLK) = 30 MHz.



**FIGURE 4-13:** SNR/SINAD/ENOB vs.  $V_{REF}$

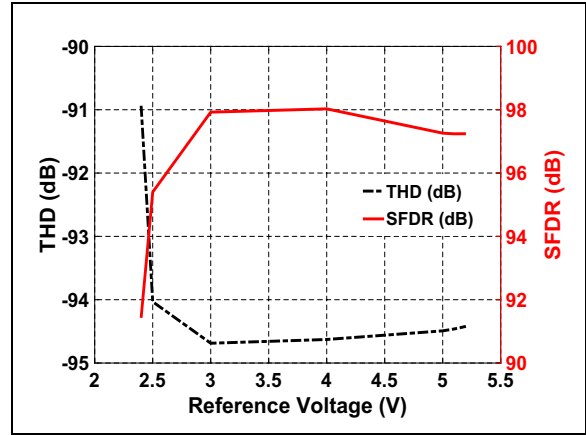

**FIGURE 4-16:** SFDR/THD vs.  $V_{REF}$

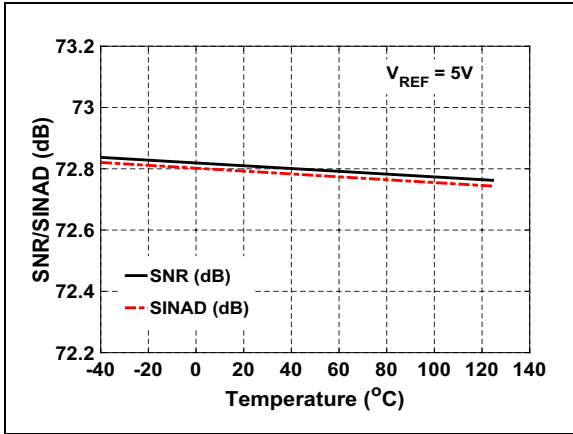

**FIGURE 4-14:** SNR/SINAD vs. Temperature:  $V_{REF} = 5\text{V}$ .

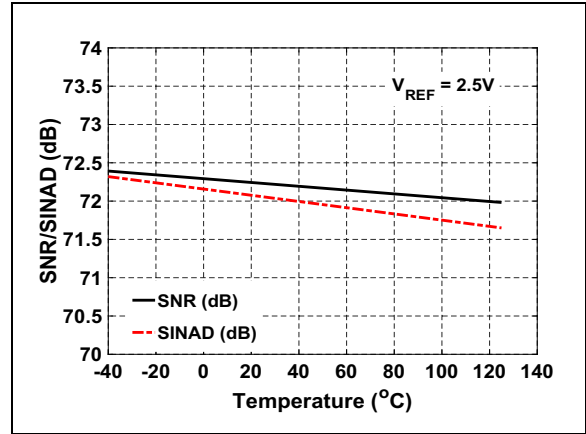

**FIGURE 4-17:** SNR/SINAD vs. Temperature:  $V_{REF} = 2.5\text{V}$ .

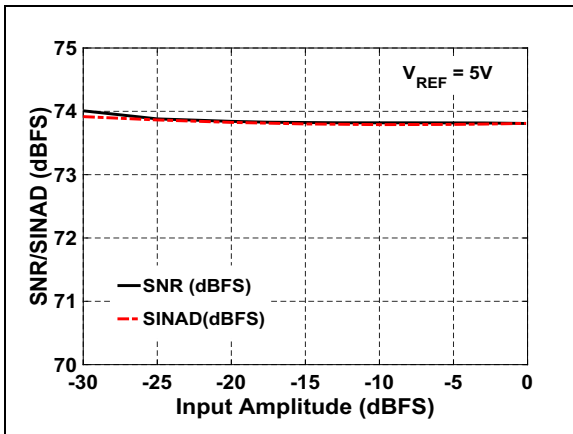

**FIGURE 4-15:** SNR/SINAD vs. Input Amplitude:  $F_{IN} = 10\text{ kHz}$ .

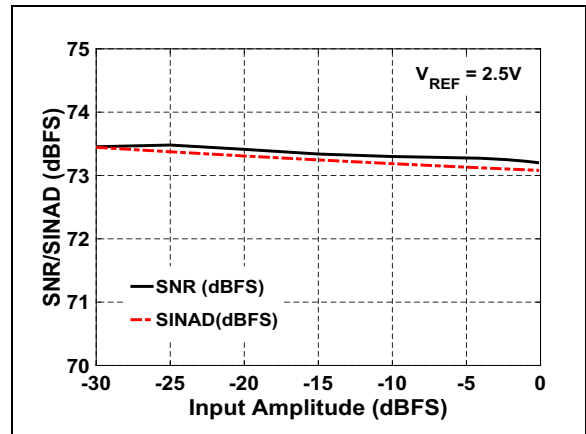

**FIGURE 4-18:** SNR/SINAD vs. Input Amplitude:  $F_{IN} = 10\text{ kHz}$ .

# MCP33131/MCP33121/MCP33111-XX

**Note:** Unless otherwise specified, all parameters apply for  $T_A = +25^\circ\text{C}$ ,  $AV_{DD} = 1.8\text{V}$ ,  $DV_{IO} = 3.3\text{V}$ ,  $V_{REF} = 5\text{V}$ ,  $\text{GND} = 0\text{V}$ , Differential Analog Input ( $V_{IN}$ ) = -1 dBFS,  $f_{IN} = 10\text{ kHz}$ ,  $C_{LOAD\_SDO} = 20\text{ pF}$ .  
**MCP33111-10:** Sample Rate ( $f_S$ ) = 1 Msps, SPI Clock Input (SCLK) = 60 MHz.  
**MCP33111-05:** Sample Rate ( $f_S$ ) = 500 kSPS, SPI Clock Input (SCLK) = 30 MHz.

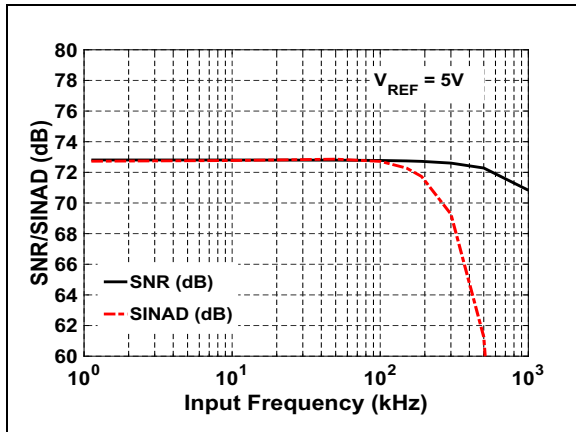

**FIGURE 4-19:** SNR/SINAD vs. Input Frequency:  $V_{IN} = -1\text{ dBFS}$ .

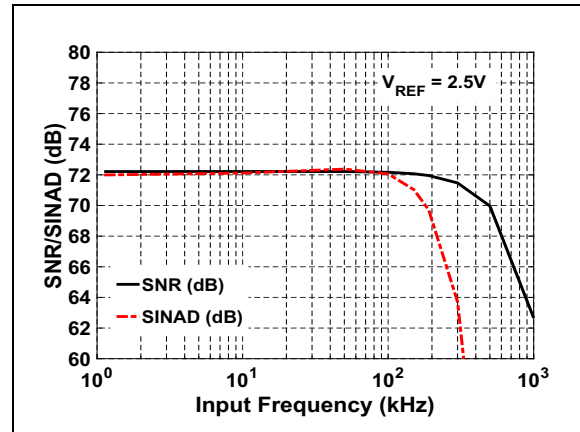

**FIGURE 4-22:** SNR/SINAD vs. Input Frequency:  $V_{IN} = -1\text{ dBFS}$ .

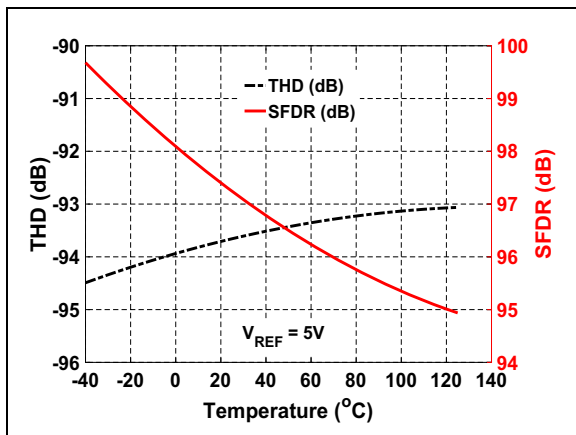

**FIGURE 4-20:** THD/SFDR vs. Temperature:  $V_{REF} = 5\text{V}$ .

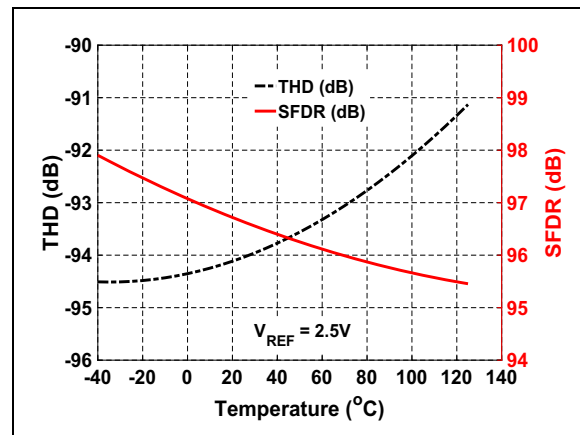

**FIGURE 4-23:** THD/SFDR vs. Temperature:  $V_{REF} = 2.5\text{V}$ .

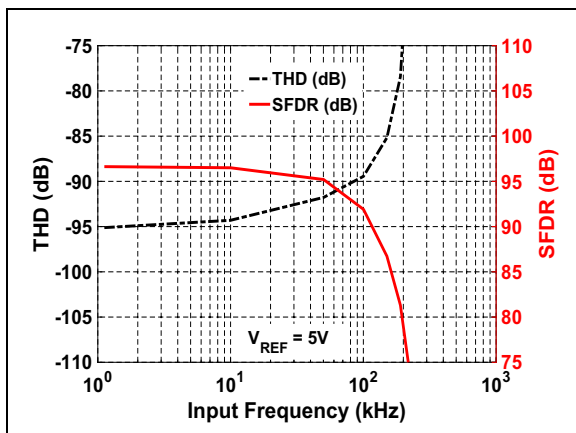

**FIGURE 4-21:** THD/SFDR vs. Input Frequency:  $V_{REF} = 5\text{V}$ .

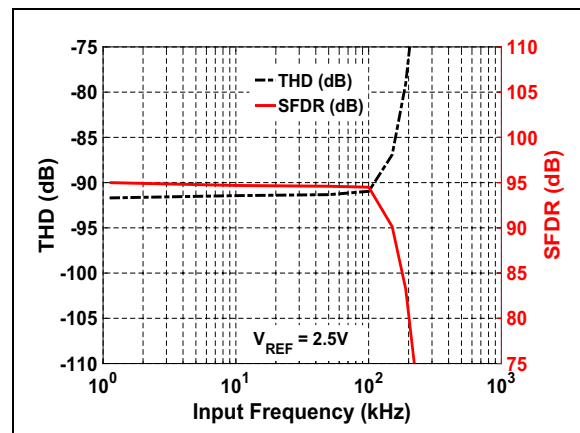

**FIGURE 4-24:** THD/SFDR vs. Input Frequency:  $V_{REF} = 2.5\text{V}$ .

# MCP33131/MCP33121/MCP33111-XX

**Note:** Unless otherwise specified, all parameters apply for  $T_A = +25^\circ\text{C}$ ,  $V_{DD} = 1.8\text{V}$ ,  $DV_{IO} = 3.3\text{V}$ ,  $V_{REF} = 5\text{V}$ ,  $\text{GND} = 0\text{V}$ , Differential Analog Input ( $V_{IN}$ ) = -1 dBFS,  $f_{IN} = 10\text{ kHz}$ ,  $C_{LOAD\_SDO} = 20\text{ pF}$ .  
**MCP33111-10:** Sample Rate ( $f_S$ ) = 1 Msps, SPI Clock Input (SCLK) = 60 MHz.  
**MCP33111-05:** Sample Rate ( $f_S$ ) = 500 kSPS, SPI Clock Input (SCLK) = 30 MHz.

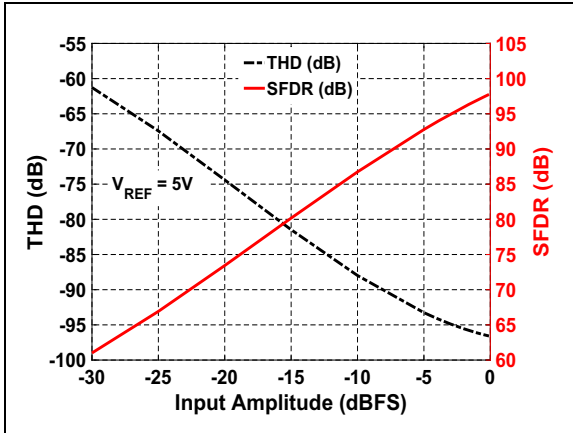

**FIGURE 4-25:** THD/SFDR vs. Input Amplitude:  $V_{REF} = 5\text{V}$ .

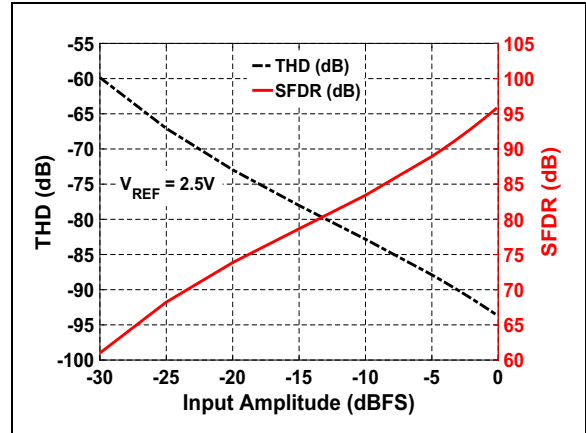

**FIGURE 4-28:** THD/SFDR vs. Input Amplitude:  $V_{REF} = 2.5\text{V}$ .

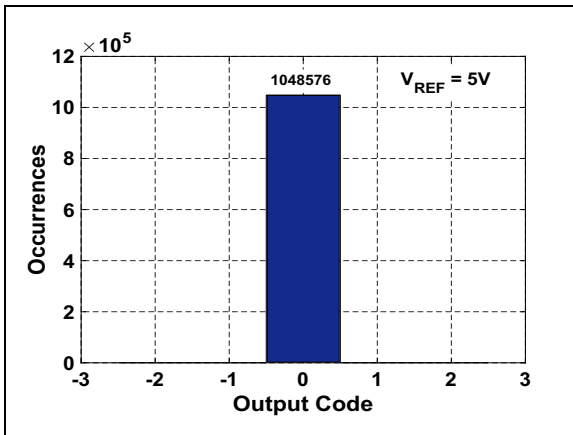

**FIGURE 4-26:** Shorted Input Histogram:  $V_{REF} = 5\text{V}$ .

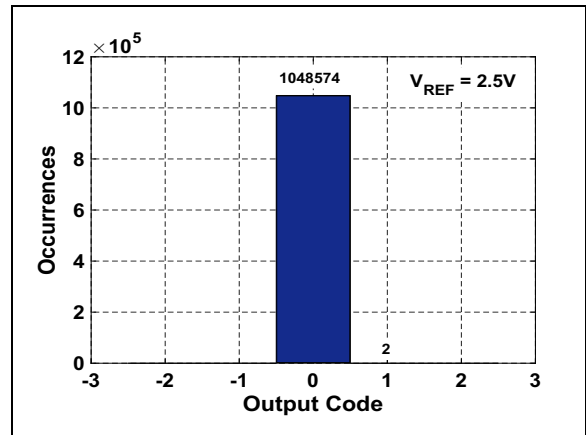

**FIGURE 4-29:** Shorted Input Histogram:  $V_{REF} = 2.5\text{V}$ .

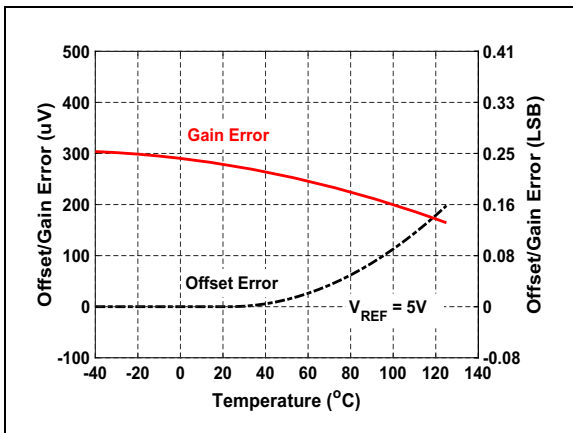

**FIGURE 4-27:** Offset and Gain Error vs. Temperature:  $V_{REF} = 5\text{V}$ .

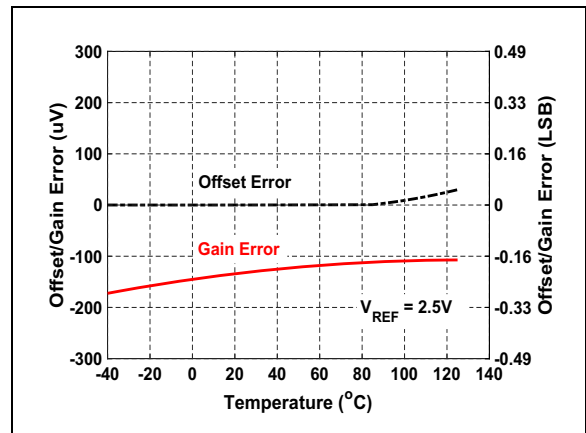

**FIGURE 4-30:** Offset and Gain Error vs. Temperature:  $V_{REF} = 2.5\text{V}$ .

# MCP33131/MCP33121/MCP33111-XX

**Note:** Unless otherwise specified, all parameters apply for  $T_A = +25^\circ\text{C}$ ,  $V_{DD} = 1.8\text{V}$ ,  $DV_{IO} = 3.3\text{V}$ ,  $V_{REF} = 5\text{V}$ ,  $\text{GND} = 0\text{V}$ , Differential Analog Input ( $V_{IN}$ ) = -1 dBFS,  $f_{IN} = 10\text{ kHz}$ ,  $C_{LOAD\_SDO} = 20\text{ pF}$ .  
**MCP33111-10:** Sample Rate ( $f_S$ ) = 1 Msps, SPI Clock Input (SCLK) = 60 MHz.  
**MCP33111-05:** Sample Rate ( $f_S$ ) = 500 kSPS, SPI Clock Input (SCLK) = 30 MHz.

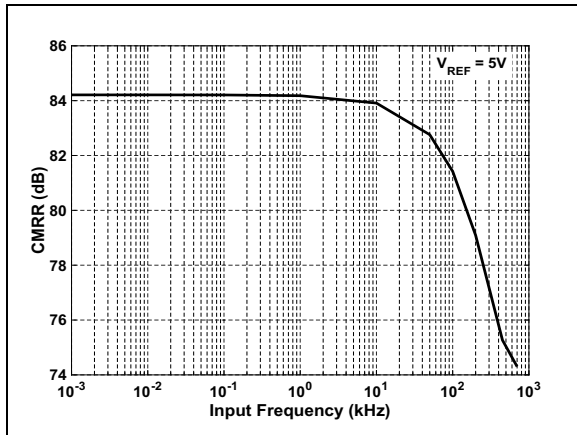

**FIGURE 4-31:** CMRR vs. Input Frequency:  $V_{REF} = 5\text{V}$ .

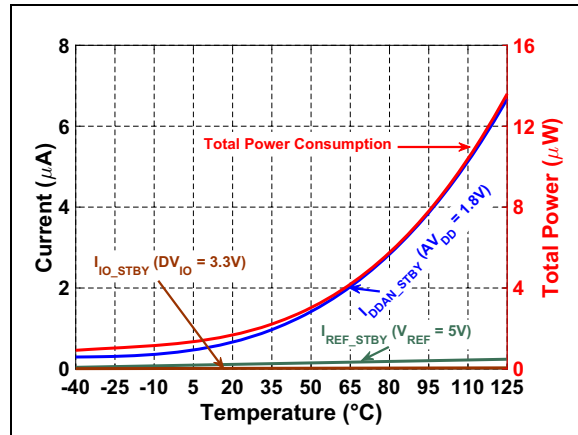

**FIGURE 4-34:** Power Consumption vs. Temperature During Shutdown.

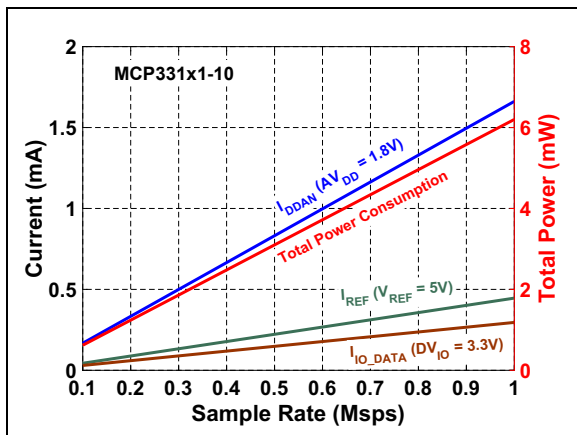

**FIGURE 4-32:** Power Consumption vs. Sample Rate:  $C_{LOAD\_SDO} = 20\text{ pF}$ .

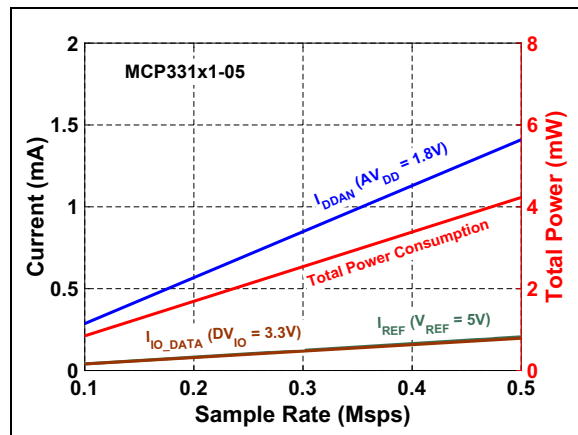

**FIGURE 4-35:** Power Consumption vs. Sample Rate:  $C_{LOAD\_SDO} = 20\text{ pF}$ .

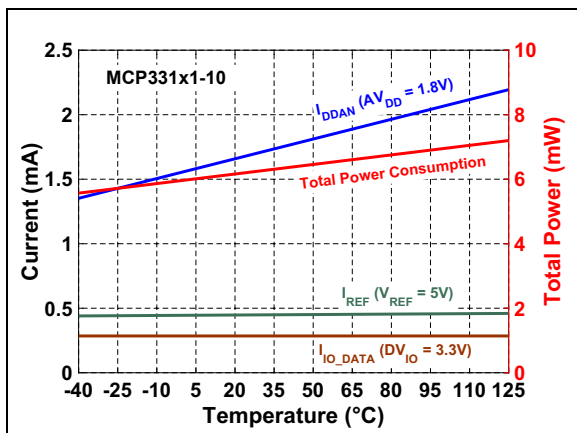

**FIGURE 4-33:** Power Consumption vs. Temperature:  $C_{LOAD\_SDO} = 20\text{ pF}$ .

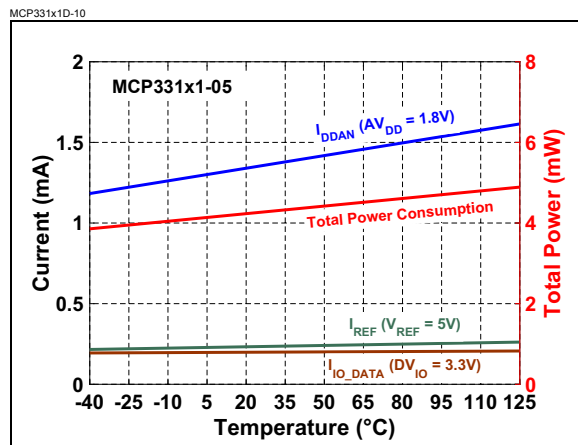

**FIGURE 4-36:** Power Consumption vs. Temperature:  $C_{LOAD\_SDO} = 20\text{ pF}$ .

# MCP33131/MCP33121/MCP33111-XX

## 5.0 PIN FUNCTION DESCRIPTIONS

TABLE 5-1: PIN FUNCTION TABLE

Pin Number	Pin Name	Function
1	V <sub>REF</sub>	Reference voltage input (2.5V - 5.1V). This pin should be decoupled with a 10 $\mu$ F tantalum capacitor.
2	AV <sub>DD</sub>	DC supply voltage input for analog section (1.8V). This pin should be decoupled with a 1 $\mu$ F ceramic capacitor.
3	A <sub>IN+</sub>	Analog input.
4	A <sub>IN-</sub>	Ground reference pin for analog input. Connect this pin to the ground reference of the analog input.
5	GND	Power supply ground reference. This pin is a common ground for both the analog power supply (AV <sub>DD</sub> ) and digital I/O supply (DV <sub>IO</sub> ).
6	CNVST	Conversion-start control and active-low SPI chip-select digital input. A new conversion is started on the rising edge of CNVST. When the conversion is complete, output data is available at SDO by lowering CNVST.
7	SDO	SPI-compatible serial digital data output: ADC conversion data is shifted out by SCLK clock, with MSB first.
8	SCLK	SPI-compatible serial data clock digital input. The ADC output is synchronously shifted out by this clock.
9	SDI	SPI-compatible serial data digital input. Tie to DV <sub>IO</sub> for normal operation.
10	DV <sub>IO</sub>	DC supply voltage for digital input/output interface (1.7V - 5.5V). This pin should be decoupled with a 0.1 $\mu$ F ceramic capacitor.

### 5.1 Supply Voltages (AV<sub>DD</sub>, DV<sub>IO</sub>)

The device has two power supply pins:

- (a) Analog power supply (AV<sub>DD</sub>): 1.8V
- (b) Digital input/output interface power supply (DV<sub>IO</sub>): 1.7V to 5.5V.

The large supply voltage range of DV<sub>IO</sub> allows the device to interface with various host devices that are operating with different supply voltages. See [Table 1-2](#) for timing specifications for I/O interface signal parameters depending on DV<sub>IO</sub> voltage.

**Note:** Proper decoupling capacitors (1  $\mu$ F to AV<sub>DD</sub>, 0.1  $\mu$ F to DV<sub>IO</sub>) should be mounted as close as possible to the respective pins. See [Figure 6-1](#) for example circuit.

### 5.2 Reference Voltage (V<sub>REF</sub>)

The device requires a single-ended external reference voltage (V<sub>REF</sub>). The external input reference range is from 2.5V to 5.1V. This reference voltage sets the input full-scale range from 0V to V<sub>REF</sub>. See [Figure 6-1](#) to [Figure 6-2](#) for example application circuit and reference voltage settings.

**Note:** The reference pin needs a tantalum decoupling capacitor (10  $\mu$ F, 10V rating). Additional multiple ceramic capacitors can be added in parallel to decouple high-frequency noises.

**Note:** During the initial power-up sequence, the reference voltage (V<sub>REF</sub>) must be provided prior to supplying AV<sub>DD</sub> or within about 64 ms after supplying AV<sub>DD</sub>. Otherwise, it is strongly recommended to send a recalibrate command. See [Section 7.1 "Recalibrate Command"](#) for more details.

### 5.2.1 VOLTAGE REFERENCE SELECTION

The performance of the voltage reference has a large impact on the accuracy of high-precision data acquisition systems. The voltage reference should have high-accuracy, low-noise, and low-temperature drift. A  $\pm 0.1\%$  output accuracy of the reference directly corresponds to  $\pm 0.1\%$  absolute accuracy of the ADC output. The RMS output noise voltage of the reference should be less than 1/2 LSB of the ADC.

# MCP33131/MCP33121/MCP33111-XX

## 6.0 DEVICE OVERVIEW

The device converts unipolar single-ended analog input into unipolar straight binary codes.

When the MCP33131/MCP33121/MCP33111-XX is first powered-up, it performs a self-calibration and enters a low current input acquisition mode (Standby) by itself.

The external reference voltage ( $V_{REF}$ ) ranging from 2.5V to 5.1V sets the input full-scale range (FSR) from 0V to  $+V_{REF}$ .

During input acquisition (Standby), the internal input sampling capacitors are connected to the input signal, while most of the internal analog circuits are shutdown to save power. During this input acquisition time ( $t_{ACQ}$ ), the device consumes less than 1  $\mu$ A.

The user can operate the device with an easy-to-use SPI-compatible 3-wire interface.

The device initiates data conversion on the rising edge of the conversion-start control (CNVST). The data conversion time ( $t_{CNV}$ ) is set by the internal clock. Once the conversion is complete, the device starts the next input acquisition. During this input acquisition time ( $t_{ACQ}$ ), the user can clock out the output data by providing the external SPI serial clock (SCLK).

The device provides conversion data with no missing codes. This ADC device family has a large input full-scale range, high precision, high throughput with no output latency, and is an ideal choice for various ADC applications.

## 6.1 Analog Input

Figure shows a simplified equivalent circuit of the input architecture with a switched capacitor input stage. The input sampling capacitor ( $C_S^+$ ) is about 31 pF. The back-to-back diodes ( $D_1 - D_2$ ) at each input pin are ESD protection diodes. Note that these ESD diodes are tied to  $V_{REF}$ , so that each input signal can swing from 0V to  $V_{REF}$ .

The input sampling and hold circuit in  $A_{IN}^+$  path is also repeated in  $A_{IN}^-$  path. This allows the device to perform a pseudo-differential conversion of the input signal. Therefore, the common mode signal presented at both input pins is rejected. In applications,  $A_{IN}^+$  pin is for the input signal and  $A_{IN}^-$  pin is for the ground reference of the input signal. The user must connect the  $A_{IN}^-$  pin to a clean ground plane of the input signal externally.

During input acquisition phase (Standby), the sampling switches are closed and each input sees the sampling capacitor ( $\approx 31$  pF) in series with the on-resistance of the sampling switch,  $R_{SON}$  ( $\approx 200\Omega$ ).

For high-precision data conversion applications, the input voltage needs to be fully settled within 1/2 LSB during the input acquisition period ( $t_{ACQ}$ ). The settling time is directly related to the source impedance: A lower impedance source results in faster input settling

time. Although the device can be driven directly with a low impedance source, using a low noise input driver is highly recommended.

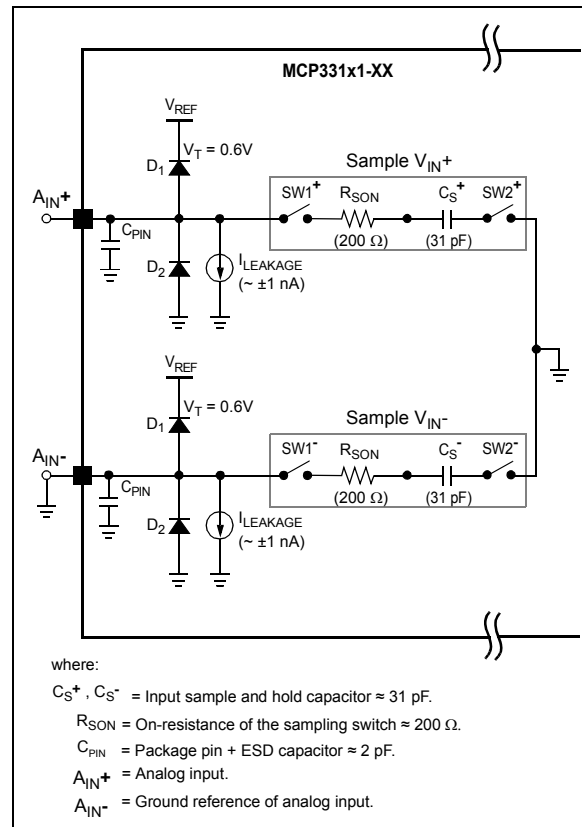

Simplified Equivalent Analog Input Circuit.

**Note:** The ESD diodes at the analog input pins are biased from  $V_{REF}$ . Any input voltage outside the absolute maximum range can turn on the input ESD protection diodes and results in input leakage current which may cause conversion errors and permanent damage to the device. Care must be taken in setting the input voltage ranges so that the input voltage does not exceed the absolute maximum input voltage range.

# MCP33131/MCP33121/MCP33111-XX

## 6.1.1 INPUT VOLTAGE RANGE

The device has two analog input pins:  $A_{IN+}$  and  $A_{IN-}$  pins. The analog input signal is applied to the  $A_{IN+}$  pin, and the ground reference of the input signal is tied to the  $A_{IN-}$  pin.

The voltage difference between  $A_{IN+}$  and  $A_{IN-}$  is the ADC input ( $V_{IN}$ ) and needs to be between 0V and  $+V_{REF}$  to produce unsaturated output codes. Equation 6-4 shows the input full-scale range (FSR) and input range.

The device will output unipolar straight binary codes for the analog input. If the input ( $V_{IN}$ ) is greater than the reference voltage ( $V_{REF}$ ), the output code will be saturated. If the input ( $V_{IN}$ ) is less than or equals to 0V, the output will be all 0's.

### EQUATION 6-1: FSR AND INPUT RANGE

$$\text{Input Full-Scale Range (FSR)} = V_{REF}$$

$$\text{Input Range: } 0V \leq V_{IN} \leq (V_{REF} - 1LSB)$$

where  $V_{IN} = A_{IN+} - A_{IN-}$

## 6.2 Analog Input Conditioning Circuit

The MCP33131/MCP33121/MCP33111-XX can be driven directly when the source impedance of the input driver is low.

Large source impedance of the input signal may affect the ADC's performance. In general, the source impedance is less sensitive to the ADC's DC performances such as INL and DNL. However, it affects significantly to the dynamic performances such as THD, SFDR and SNR.

Therefore, it is a good design practice to isolate the ADC input from the high impedance source using a low noise input driver amplifier. Figure 6-1 shows an input configuration example using a low-noise OP amplifier such as MCP6286 and Figure 6-2 shows the transfer function of the MCP33131/MCP33121/MCP33111-XX.

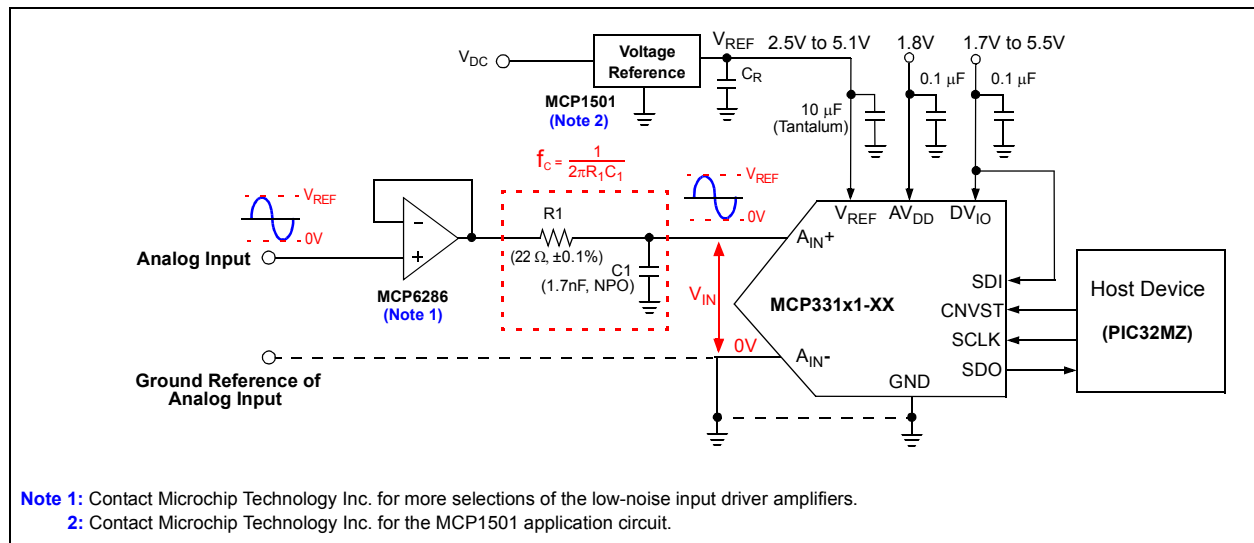

FIGURE 6-1: Unipolar-Input Application Example

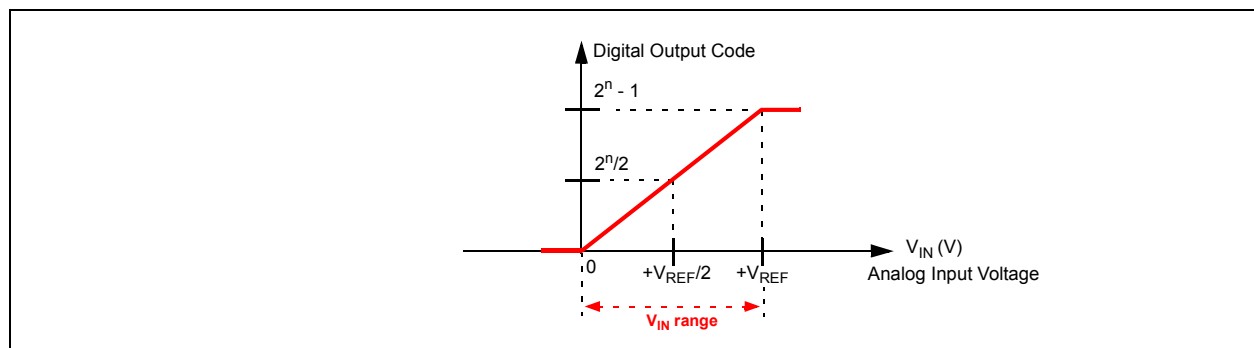

FIGURE 6-2: Transfer Function for Figure 6-1.



## 6.3 ADC Input Driver Selection

The noise and distortion of the ADC input driver can degrade the dynamic performance (SNR, SFDR, and THD) of the overall ADC application system. Therefore, the ADC input driver needs better performance specifications than the ADC itself. The data sheet of the driver typically shows the output noise voltage and harmonic distortion parameters.

Figure 6-3 shows a simplified system noise presentation block diagram for the front-end driver and ADC.

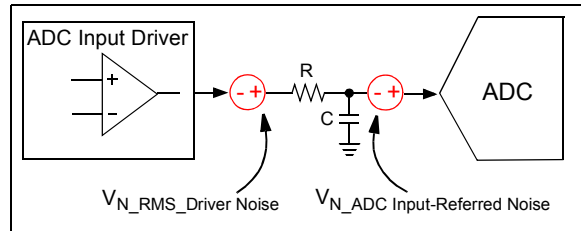

**FIGURE 6-3:** Simplified System Noise Representation.

### • Unity-Gain Bandwidth:

An input driver with higher bandwidth usually results in better overall linearity performance. Typically, the driver should have the unity-gain bandwidth greater than 5 times the -3 dB cutoff frequency of the anti-aliasing filter:

### EQUATION 6-2: BANDWIDTH REQUIREMENT FOR ADC INPUT DRIVER

$$\begin{aligned} BW_{\text{Input Driver}} &\geq 5 \times f_B \quad (\text{Hz}) \\ &\geq \frac{5}{2\pi RC} \quad \text{for a single-pole RC filter} \end{aligned}$$

where,  $f_B$  = -3 dB bandwidth of RC anti-aliasing filter as shown in Figure 6-3.

### • Distortion:

The nonlinearity characteristics of the input driver cause distortions in the ADC output. Therefore, the input driver should have less distortion than the ADC itself. The recommended total harmonic distortion (THD) of the driver is at least 10 dB less than that of the ADC:

### EQUATION 6-3: RECOMMENDED THD FOR ADC INPUT DRIVER

$$THD_{\text{Input Buffer}} \leq THD_{\text{ADC}} - 10 \quad (\text{dB})$$

### • ADC Input-Referred Noise:

When the ADC is operating with a full-scale input range, the ADC input-referred RMS noise for a single-ended input configuration is approximated as shown in Equation 6-4.

### EQUATION 6-4: ADC INPUT-REFERRED NOISE

$$V_{N\_ADC \text{ Input-Referred Noise}} = \frac{V_{REF}}{2\sqrt{2}} 10^{\frac{-SNR}{20}} \quad (\text{V})$$

### • Noise Contribution from the Front-End Driver:

The noise from the input driver can degrade the ADC's SNR performance. Therefore, the selected input driver should have the lowest possible broadband noise density and 1/f noise. When an anti-aliasing filter is used after the input driver, the output noise density of the input driver is integrated over the -3 dB bandwidth of the filter.

Equation 6-5 shows the RMS output noise voltage calculation using the RC filter's bandwidth and noise density ( $e_N$ ) of the input driver.  $G_N$  in Equation 6-5 is the noise gain of the driver amplifier and becomes 1 for a unity gain buffer driver.

### EQUATION 6-5: NOISE FROM FRONT-END DRIVER AMPLIFIER

$$V_{N\_RMS\_Driver \text{ Noise}} \approx G_N \frac{e_N}{\sqrt{2}} \sqrt{\pi f_B} \quad (\text{V})$$

where  $e_N$  is the broadband noise density ( $V/\sqrt{\text{Hz}}$ ) of the front-end driver amplifier and is typically given in its data sheet. In Equation 6-5, 1/f noise ( $e_{N\text{Flicker}}$ ) is ignored assuming it is very small compared to the broadband noise ( $e_N$ ).

For high precision ADC applications, the noise contribution from the front-end input driver amplifier is typically constrained to be less than about 20% (or 1/5 times) of the ADC input-referred noise as shown in Equation 6-6:

### EQUATION 6-6: RECOMMENDED ADC INPUT DRIVER NOISE

$$V_{N\_RMS\_Driver \text{ Noise}} \leq \frac{1}{5} V_{N\_ADC \text{ Input-Referred Noise}}$$

Using Equation 6-4 to Equation 6-6, the recommended noise voltage density ( $e_N$ ) limit of the ADC input driver is expressed in Equation 6-7:



# MCP33131/MCP33121/MCP33111-XX

**EQUATION 6-7: NOISE DENSITY FOR ADC INPUT DRIVER**

$$G_N \frac{e_N}{\sqrt{2}} \sqrt{\pi f_B} \leq \frac{1}{5} V_{N\_ADC \text{ Input-Referred Noise}}$$

$$e_N \leq \frac{1}{10} \frac{1}{G_N \sqrt{\pi f_B}} V_{REF} 10^{-\frac{SNR}{20}} \left( \frac{V}{\sqrt{Hz}} \right)$$

Using Equation 6-7, the recommended maximum noise voltage density limit for unity gain input driver for single-ended input ADC can be estimated. Table 6-1 to Table 6-3 show a few example results with  $G_N = 1$ . The user may use these tables as a reference when selecting the ADC input driver amplifier.

**TABLE 6-1: Noise Voltage Density ( $e_N$ ) of Input Driver for MCP33131-XX**

ADC (Note 1)			RC Filter	ADC Input Driver Amplifier ( $G_N = 1$ )
$V_{REF}$	SNR (dBFS)	ADC Input-Referred Noise	$f_B$ (Table 2)	Noise Voltage Density ( $e_N$ )
2.5V	81	78.8 $\mu$ V	3 MHz	7.3 nV/ $\sqrt{Hz}$
			4 MHz	6.3 nV/ $\sqrt{Hz}$
			5 MHz	5.6 nV/ $\sqrt{Hz}$
3.3V	83	82.6 $\mu$ V	3 MHz	7.6 nV/ $\sqrt{Hz}$
			4 MHz	6.6 nV/ $\sqrt{Hz}$
			5 MHz	5.9 nV/ $\sqrt{Hz}$
5V	87	79 $\mu$ V	3 MHz	7.3 nV/ $\sqrt{Hz}$
			4 MHz	6.3 nV/ $\sqrt{Hz}$
			5 MHz	5.6 nV/ $\sqrt{Hz}$

**Note** 1: See Equation 6-4 for the ADC input-referred noise calculation for single-ended input.  
2:  $f_B$  is -3dB bandwidth of the RC anti-aliasing filter.

**TABLE 6-2: Noise Voltage Density ( $e_N$ ) of Input Driver for MCP33121-XX**

ADC (Note 1)			RC Filter	ADC Input Driver Amplifier ( $G_N = 1$ )
$V_{REF}$	SNR (dBFS)	ADC Input-Referred Noise	$f_B$ (Note 2)	Noise Voltage Density ( $e_N$ )
2.5V	80	88.4 $\mu$ V	3 MHz	8.1 nV/ $\sqrt{Hz}$
			4 MHz	7.1 nV/ $\sqrt{Hz}$
			5 MHz	6.3 nV/ $\sqrt{Hz}$
3.3V	81.5	98.2 $\mu$ V	3 MHz	9.0 nV/ $\sqrt{Hz}$
			4 MHz	7.8 nV/ $\sqrt{Hz}$
			5 MHz	7.0 nV/ $\sqrt{Hz}$
5V	83.5	118.1 $\mu$ V	3 MHz	10.9 nV/ $\sqrt{Hz}$
			4 MHz	9.4 nV/ $\sqrt{Hz}$
			5 MHz	8.4 nV/ $\sqrt{Hz}$

**Note** 1: See Equation 6-4 for the ADC input-referred noise calculation for single-ended input.  
2:  $f_B$  is -3dB bandwidth of the RC anti-aliasing filter.

**TABLE 6-3: Noise Voltage Density ( $e_N$ ) of Input Driver for MCP33111-XX**

ADC (Note 1)			RC Filter	ADC Input Driver Amplifier ( $G_N = 1$ )
$V_{REF}$	SNR (dBFS)	ADC Input-Referred Noise	$f_B$ (Note 2)	Noise Voltage Density ( $e_N$ )
2.5V	73.2	193.3 $\mu$ V	3 MHz	17.8 nV/ $\sqrt{Hz}$
			4 MHz	15.4 nV/ $\sqrt{Hz}$
			5 MHz	13.8 nV/ $\sqrt{Hz}$
3.3V	73.5	246.6 $\mu$ V	3 MHz	22.7 nV/ $\sqrt{Hz}$
			4 MHz	19.7 nV/ $\sqrt{Hz}$
			5 MHz	17.6 nV/ $\sqrt{Hz}$
5V	73.8	360.9 $\mu$ V	3 MHz	33.3 nV/ $\sqrt{Hz}$
			4 MHz	28.8 nV/ $\sqrt{Hz}$
			5 MHz	25.8 nV/ $\sqrt{Hz}$

**Note** 1: See Equation 6-4 for the ADC input-referred noise calculation for single-ended input.  
2:  $f_B$  is -3dB bandwidth of the RC anti-aliasing filter.

# MCP33131/MCP33121/MCP33111-XX

## 6.4 Device Operation

When the MCP33131/MCP33121/MCP33111-XX is first powered-up, it self-calibrates internal systems and enters input acquisition mode by itself. The device operates in two phases: (a) Input Acquisition (Standby) and (b) Data Conversion. Figure 6-4 shows the ADC operating sequence.

### 6.4.1 INPUT ACQUISITION PHASE (STANDBY)

During the input acquisition phase ( $t_{ACQ}$ ), also called Standby, the two input sampling capacitors,  $C_S^+$  and  $C_S^-$ , are connected to the  $A_{IN}^+$  and  $A_{IN}^-$  pins, respectively. The input voltage is sampled until a rising edge on CNVST is detected. The input voltage should be fully settled within 1/2 LSB during  $t_{ACQ}$ .

During this input acquisition time ( $t_{ACQ}$ ), the ADC consumes less than 1  $\mu$ A. The acquisition time ( $t_{ACQ}$ ) is user-controllable. This acquisition time ( $t_{ACQ}$ ) can be increased as long as needed for additional power savings.

### 6.4.2 DATA CONVERSION PHASE

The start of the conversion is controlled by CNVST. On the rising edge of CNVST, the sampled charge is locked (sample switches are opened) and the ADC performs the conversion. Once a conversion is started, it will not stop until the current conversion is complete. The data conversion time ( $t_{CNV}$ ) is not user-controllable. After the conversion is complete and the host lowers CNVST, the output data is presented on SDO.

Any noise injection during the conversion phase may affect the accuracy of the conversion. To reduce environment noise, minimize I/O events and running clocks during the conversion time.

The output data is clocked out MSB first. While the output data is being transferred, the device enters the next input acquisition phase.

**Note:** Transferring output data during the acquisition phase can disturb the next input sample. It is highly recommended to allow at least  $t_{QUIET}$  (10 ns, typical) between the last edge on the SPI interface and the rising edge on CNVST. See Figure 1-1 for  $t_{QUIET}$ .

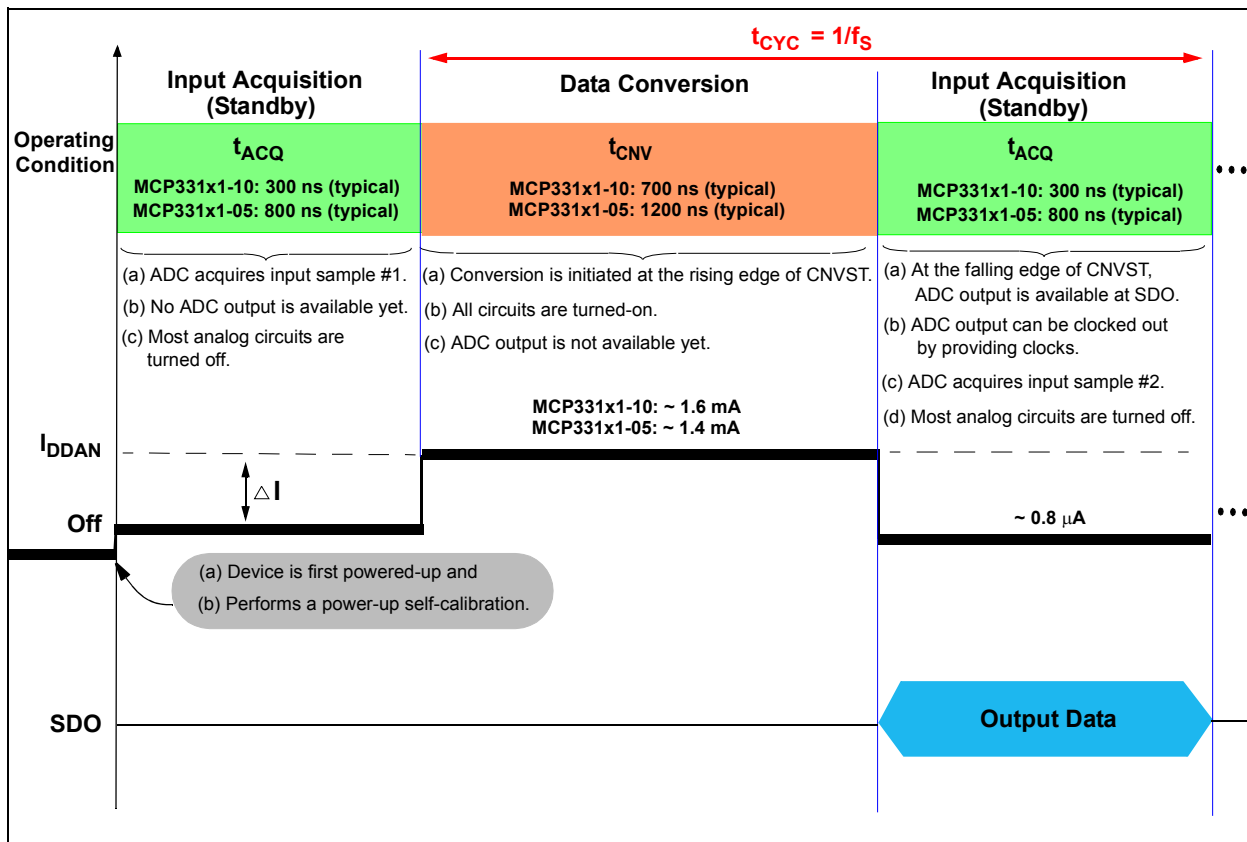

FIGURE 6-4: Device Operating Sequence.

# MCP33131/MCP33121/MCP33111-XX

## 6.4.3 SAMPLE (THROUGHPUT) RATE

The device completes data conversion within the maximum specification of the data conversion time ( $t_{CNV}$ ). The continuous input sample rate is the inverse of the sum of input acquisition time ( $t_{ACQ}$ ) and data conversion time ( $t_{CNV}$ ). Equation 6-8 shows the continuous sample rate calculation using the minimum and maximum specifications of the input acquisition time ( $t_{ACQ}$ ) and data conversion time ( $t_{CNV}$ ).

### EQUATION 6-8: SAMPLE RATE

$$\text{Sample Rate} = \frac{1}{(t_{ACQ} + t_{CNV})}$$

(a) MCP331x1-10:  

$$\text{Sample Rate} = \frac{1}{(290\text{ns} + 710\text{ns})} = 1 \text{ MspS}$$

(b) MCP331x1-05:  

$$\text{Sample Rate} = \frac{1}{(700\text{ns} + 1300\text{ns})} = 500 \text{ kSPS}$$

## 6.4.4 SERIAL SPI CLOCK FREQUENCY REQUIREMENT

The ADC output is collected during the input acquisition time ( $t_{ACQ}$ ). For continuous input sampling and data conversion sequence, the SPI clock frequency should be fast enough to clock out all output data bits during the input acquisition time ( $t_{ACQ}$ ). For the continuous sampling rate ( $f_S$ ), the minimum SPI clock frequency requirement is determined by the following equation:

### EQUATION 6-9: SPI CLOCK FREQUENCY REQUIREMENT

$$t_{ACQ} = N \times T_{SCLK} + t_{QUIET} + t_{EN}$$

$$f_{SCLK} = \frac{1}{T_{SCLK}} = \frac{N}{t_{ACQ} - (t_{QUIET} + t_{EN})}$$

where N is the number of output data bits, given by

- N = 16-bit for MCP33131-XX
- = 14-bit for MCP33121-XX
- = 12-bit for MCP33111-XX
- $T_{SCLK}$  = Period of SPI clock
- $N \times T_{SCLK}$  = Output data window
- $t_{QUIET}$  = Quiet time between the last output bit and beginning of the next conversion start.
- = 10 ns (min)
- $t_{EN}$  = Output enable time = 10 ns (max), with  $DV_{IO} \geq 2.3V$

**Note:** See Figure 1-1 for digital interface timing diagram.

where  $f_{SCLK}$  is the minimum SPI serial clock frequency required to transfer all N-bits of output data during input acquisition time ( $t_{ACQ}$ ).

Table 6-4 and Table 6-5 show the examples of calculated minimum SPI clock ( $f_{SCLK}$ ) requirements for various input acquisition times for 1 MspS and 500 kSPS family devices, respectively.

**TABLE 6-4: SPI CLOCK SPEED VS. INPUT ACQUISITION TIME ( $T_{ACQ}$ ) FOR MCP331X1-10**

Input Acquisition Time: $t_{ACQ}$ (nS) (Note 4)	Data Conversion Time: $t_{CNV}$ (nS) (Note 5)	SPI Clock ( $f_{SCLK}$ ) Speed Requirement (Note 1), (Note 2)			Sample Rate: $f_S$ (MspS)	Conditions
		MCP33131-10 (16-bit)	MCP33121-10 (14-bit)	MCP33111-10 (12-bit)		
250	750	69.57 MHz	60.87 MHz	52.17 MHz	1	$85^\circ\text{C} < T_A \leq 125^\circ\text{C}$ (Note 3)
270		64 MHz	56 MHz	48 MHz	0.98	
280		61.54 MHz	53.85 MHz	46.15 MHz	0.97	
290	710	59.26 MHz	51.85 MHz	44.44 MHz	1	$-40^\circ\text{C} \leq T_A \leq 85^\circ\text{C}$
300		57.15 MHz	50 MHz	42.86 MHz	0.99	
320		53.33 MHz	46.67 MHz	40 MHz	0.97	
400		42.11 MHz	36.84 MHz	30 MHz	0.9	
540		30.77 MHz	26.92 MHz	23.08 MHz	0.8	
720		22.86 MHz	20 MHz	17.14 MHz	0.7	
720		17.2 MHz	15.05 MHz	12.9 MHz	0.6	
1290		12.6 MHz	11.02 MHz	9.45 MHz	0.5	
1750		9.04 MHz	7.91 MHz	6.78 MHz	0.4	
2620		6.15 MHz	5.39 MHz	4.62 MHz	0.3	
4290		3.75 MHz	3.28 MHz	2.81 MHz	0.2	
9290	1.73 MHz	1.51 MHz	1.3 MHz	0.1		

- Note**
- 1: This is the minimum SPI clock speed requirement to collect all N-bits of the ADC output during the input acquisition time ( $t_{ACQ}$ ), when the ADC is operating in continuous input sampling mode.
  - 2: See Equation 6-9 for the calculation of the SPI clock speed requirement.
  - 3: In extended temperature range, the device takes longer data conversion time ( $t_{CNV}$ : 750 nS, max). Using a shorter input acquisition time is recommended ( $t_{ACQ}$ : 250 nS) for 1 MspS throughput rate.
  - 4: Input acquisition time ( $t_{ACQ}$ ) is user-controllable.
  - 5: Data conversion time ( $t_{CNV}$ ) is not user-controllable.

# MCP33131/MCP33121/MCP33111-XX

**TABLE 6-5: SPI CLOCK SPEED VS. INPUT ACQUISITION TIME (T<sub>ACQ</sub>) FOR MCP331X1-05**

Input Acquisition Time: t <sub>ACQ</sub> (nS) (Note 3)	Data Conversion Time: t <sub>CNV</sub> (nS) (Note 4)	SPI Clock (f <sub>SCLK</sub> ) Speed Requirement (Note 1), (Note 2)			Sample Rate: f <sub>S</sub> (kSPS)	Conditions
		MCP33131-05 (16-bit)	MCP33121-05 (14-bit)	MCP33111-05 (12-bit)		
700	1300	23.53MHz	20.59 MHz	17.65 MHz	500	-40°C ≤ T <sub>A</sub> ≤ 125°C
740		22.22 MHz	19.44 MHz	16.67 MHz	490	
790		20.78 MHz	18.18 MHz	15.58 MHz	480	
930		17.58 MHz	15.39 MHz	13.19 MHz	450	
1200		13.56 MHz	11.86 MHz	10.17 MHz	400	
1560		10.39 MHz	9.09 MHz	7.79 MHz	350	
2030		7.96 MHz	6.97 MHz	5.97 MHz	300	
2700		5.97 MHz	5.22MHz	4.48 MHz	250	
3700		4.35 MHz	3.8 MHz	3.26 MHz	200	
5370		2.99 MHz	2.62 MHz	2.25 MHz	150	
8700		1.84 MHz	1.61 MHz	1.38 MHz	100	

**Note 1:** This is the minimum SPI clock speed requirement to collect all N-bits of the ADC output during the input acquisition time (t<sub>ACQ</sub>), when the ADC is operating in continuous input sampling mode.  
**Note 2:** See Equation 6-9 for the calculation of the SPI clock speed requirement.  
**Note 3:** Input acquisition time (t<sub>ACQ</sub>) is user-controllable.  
**Note 4:** Data conversion time (t<sub>CNV</sub>) is not user-controllable.

## 6.5 Transfer Function

The pseudo-differential analog input is:

$$V_{IN} = (V_{IN+}) - (V_{IN-})$$

where V<sub>IN+</sub> is the analog input voltage at A<sub>IN+</sub> pin with respect to the ground reference (GND), and Vin- is the voltage at A<sub>IN-</sub> pin, which is 0V when tied to the analog input ground reference (GND).

The LSB size is given by Equation 6-10. and an example of LSB size vs. reference voltage is summarized in Table 6-6.

**EQUATION 6-10: LSB SIZE - EXAMPLE**

$$LSB = \frac{V_{REF}}{2^N}$$

where N is the resolution of the ADC in bits.

**TABLE 6-6: LSB SIZE VS. REFERENCE**

Reference Voltage (V <sub>REF</sub> )	LSB Size		
	MCP33131-XX (16-bit)	MCP33121-XX (14-bit)	MCP33111-XX (12-bit)
2.5V	38.2μV	152.6 μV	0.6104 mV
2.7V	41.2 μV	164.8 μV	0.6592 mV
3V	45.8 μV	183.1 μV	0.7324 mV
3.3V	50.4 μV	201.4 μV	0.8057 mV
3.5V	53.4 μV	213.6 μV	0.8545 mV
4V	61.0 μV	244.1 μV	0.9766 mV
4.5V	68.7 μV	274.7 μV	1.0986 mV
5V	76.3 μV	305.2 μV	1.2207 mV

5.1	77.8 μV	311.3 μV	1.2451 mV
-----	---------	----------	-----------

Figure 6-5 shows the ideal transfer function and Table 6-7 shows the digital output codes for the MCP33131/MCP33121/MCP33111-XX.

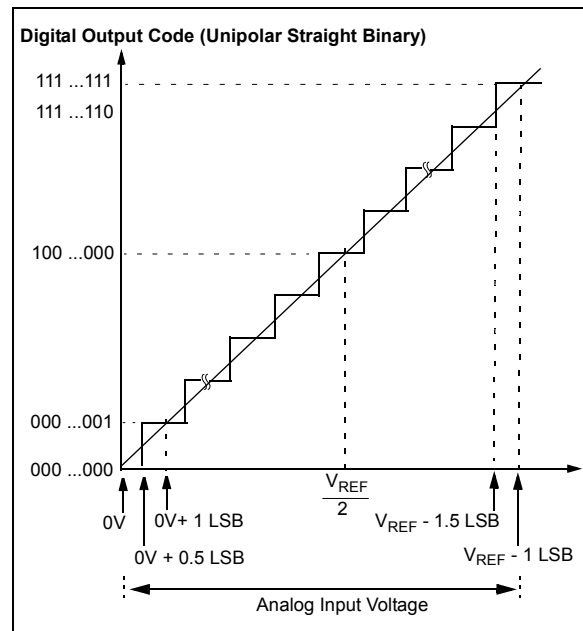

**FIGURE 6-5: Ideal Transfer Function.**

# MCP33131/MCP33121/MCP33111-XX

## 6.6 Digital Output Code

The digital output code is proportional to the input voltage. The output data is in unipolar straight binary format. The following is an example of the output code:

(a) for a zero or negative input:

**Analog Input:**  $V_{IN} \leq 0$  (V)

**Output Code:** 0000...0000

(b) for a mid-scale input:

**Analog Input:**  $V_{IN} = +V_{REF}/2$  (V)

**Output Code:** 1000...0000

(c) for a positive full-scale input:

**Analog Input:**  $V_{IN} = +V_{REF}$  (V)

**Output Code:** 1111...1111

The code will be locked at 1111...11 for all voltages greater than  $(V_{REF} - 1 \text{ LSB})$  and 0000...00 for voltages less than 0V. Table 6-7 shows an example of output codes of various input levels.

**TABLE 6-7: DIGITAL OUTPUT CODE**

Input Voltage (V)	Digital Output Codes		
	MCP33131-XX (16-bit)	MCP33121-XX (14-bit)	MCP33111-XX (12-bit)
$V_{REF}$	1111-1111-1111-1111	11-1111-1111-1111	1111-1111-1111
$V_{REF} - 1 \text{ LSB}$	1111-1111-1111-1111	11-1111-1111-1111	1111-1111-1111
.	.	.	.
$V_{REF}/2$	1000-0000-0000-0000	10-0000-0000-0000	1000-0000-0000
.	.	.	.
2 LSB	0000-0000-0000-0010	00-0000-0000-0010	0000-0000-0010
1 LSB	0000-0000-0000-0001	00-0000-0000-0001	0000-0000-0001
$\leq 0V$	0000-0000-0000-0000	00-0000-0000-0000	0000-0000-0000

# MCP33131/MCP33121/MCP33111-XX

## 7.0 DIGITAL SERIAL INTERFACE

The device has a SPI-compatible serial digital interface using four digital pins: CNVST, SDI, SDO and SCLK.

Figure 7-1 shows the connection diagram with the host device and Figure 7-2 shows the SPI-compatible serial interface timing diagram.

The SDI pin can be tied to the digital I/O interface supply voltage ( $DV_{IO}$ ) or just maintain logic “High” level by the host. The CNVST pin is used for both chip select ( $\overline{CS}$ ) and conversion-start control.

A rising edge on CNVST initiates the conversion process. Once the conversion is initiated, the device will complete the conversion regardless of the state of CNVST. This means the CNVST pin can be used for other purposes during  $t_{CNV}$ .

When the conversion is complete, the output is available at SDO by lowering CNVST. Data is sent MSB-first and changes on the falling edge of SCLK.

Output data can be sampled on either edge of SCLK. However, a digital host capturing data on the falling edge of SCLK can achieve a faster read out rate.

SDO returns to high-Z state after the last data bit is clocked out or when CNVST goes high, whichever occurs first.

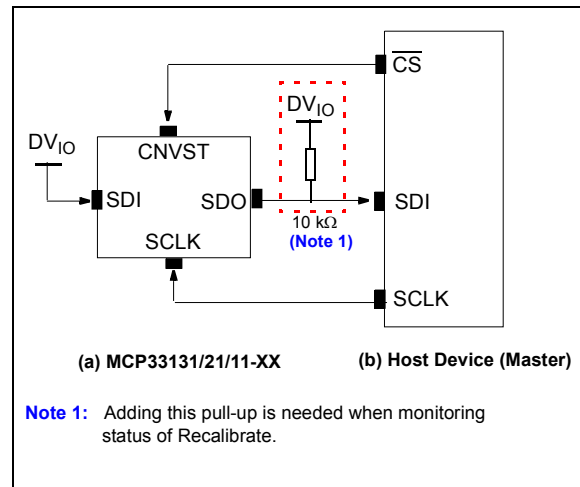

**FIGURE 7-1:** Digital Interface Connection Diagram.

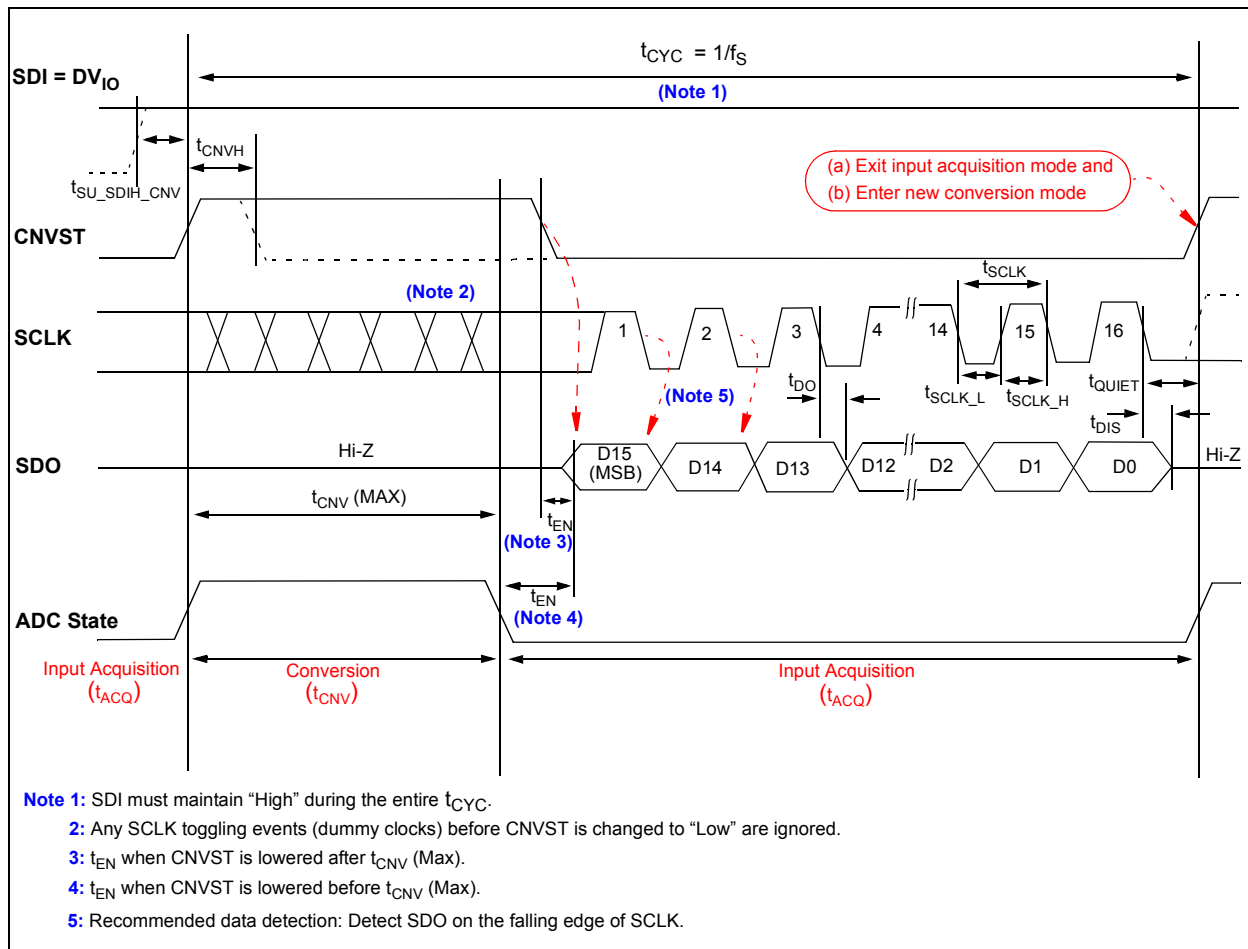

**FIGURE 7-2:** SPI Compatible Serial Interface Timing Diagram (16-bit device).

# MCP33131/MCP33121/MCP33111-XX

## 7.1 Recalibrate Command

The user may use the recalibrate command in the following cases:

- When the reference voltage was not fully settled during the first-power sequence.
- During operation, to ensure optimum performance across varying environment conditions, such as reference voltage and temperature.

A self-calibration is initiated by sending the recalibrate command. The host device sends a recalibrate command by transmitting 1024 SCLK pulses (including the clocks for data bits) while the device is in the acquisition phase (Standby).

The device drives SDO low during the recalibration procedure, and returns to high-Z once completed. The status of the recalibration procedure can be monitored by placing a pull-up on SDO, so that SDO goes high when the recalibration is complete.

Figure 7-3 shows the recalibrate command timing diagram. The calibration takes approximately 500 ms ( $t_{CAL}$ ).

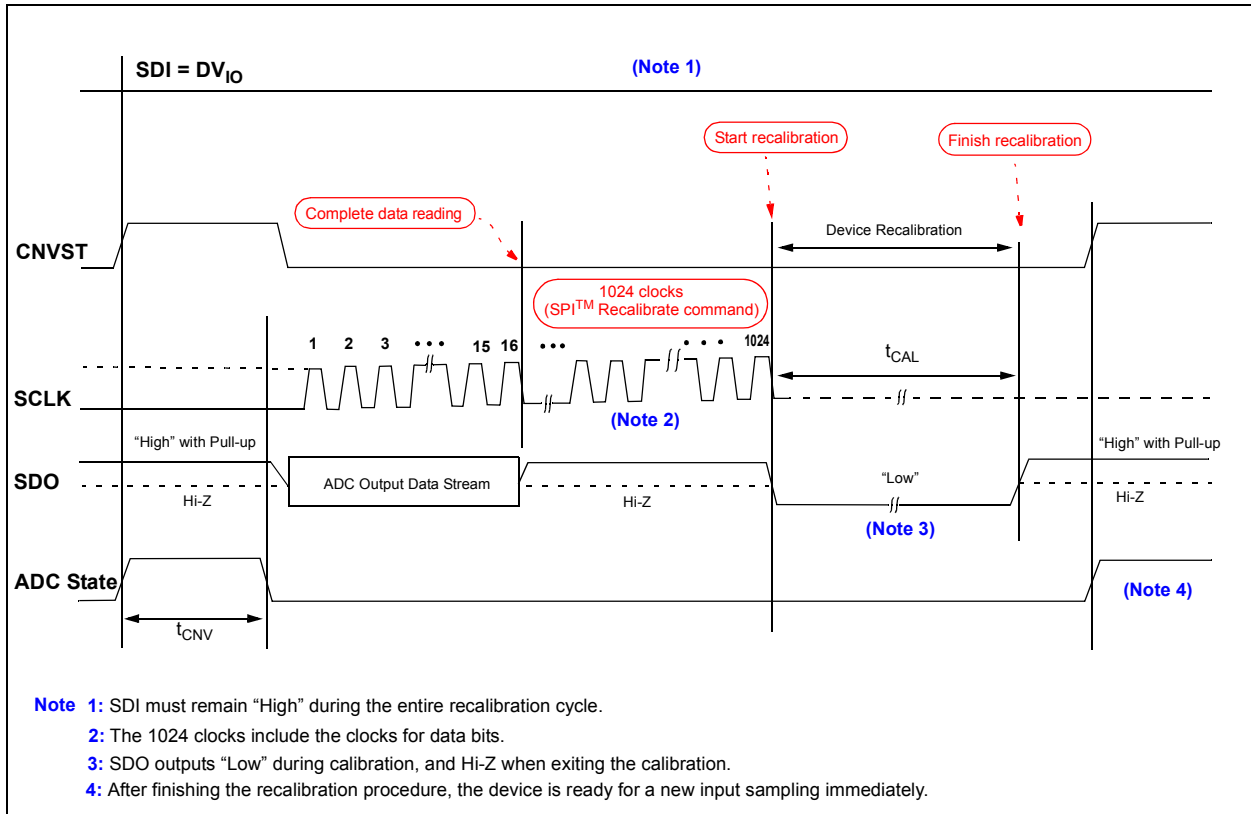

**FIGURE 7-3:** Recalibrate Command Timing Diagram.

**Note:** When the device performs a self-calibration, it is important to note that both  $AV_{DD}$  and the reference voltage ( $V_{REF}$ ) must be stabilized for a correct calibration. This is also true when the device is first powered-up, the reference voltage ( $V_{REF}$ ) must be stabilized before self-calibration begins. This means the  $V_{REF}$  must be provided prior to supplying  $AV_{DD}$  or within about 64 ms after supplying  $AV_{DD}$ .

# MCP33131/MCP33121/MCP33111-XX

---

---

NOTES:



# MCP33131/MCP33121/MCP33111-XX

## 8.0 TERMINOLOGY

### Analog Input Bandwidth (Full-Power Bandwidth)

The analog input frequency at which the spectral power of the fundamental frequency (as determined by FFT analysis) is reduced by 3 dB.

### Aperture Delay or Sampling Delay

This is the time delay between the rising edge of the CNVST input and when the input signal is held for a conversion.

### Differential Nonlinearity (DNL, No Missing Codes)

An ideal ADC exhibits code transitions that are exactly 1 LSB apart. DNL is the deviation from this ideal value. No missing codes to 16-bit resolution indicates that all 65,536 codes (16,384 codes for 14-bit, 4096 codes for 12-bit) must be present over all the operating conditions.

### Integral Nonlinearity (INL)

INL is the maximum deviation of each individual code from an ideal straight line drawn from negative full scale through positive full scale.

### Signal-to-Noise Ratio (SNR)

SNR is the ratio of the power of the fundamental ( $P_S$ ) to the noise floor power ( $P_N$ ), below the Nyquist frequency and excluding the power at DC and the first nine harmonics.

#### EQUATION 8-1:

$$SNR = 10 \log \left( \frac{P_S}{P_N} \right)$$

SNR is either given in units of dBc (dB to carrier), when the absolute power of the fundamental is used as the reference, or dBFS (dB to full-scale), when the power of the fundamental is extrapolated to the converter full-scale range.

### Signal-to-Noise and Distortion (SINAD)

SINAD is the ratio of the power of the fundamental ( $P_S$ ) to the power of all the other spectral components including noise ( $P_N$ ) and distortion ( $P_D$ ) below the Nyquist frequency, but excluding DC:

#### EQUATION 8-2:

$$\begin{aligned} SINAD &= 10 \log \left( \frac{P_S}{P_D + P_N} \right) \\ &= -10 \log \left[ 10^{\frac{SNR}{10}} - 10^{\frac{THD}{10}} \right] \end{aligned}$$

SINAD is either given in units of dBc (dB to carrier), when the absolute power of the fundamental is used as the reference, or dBFS (dB to full-scale), when the power of the fundamental is extrapolated to the converter full-scale range.

### Effective Number of Bits (ENOB)

The effective number of bits for a sine wave input at a given input frequency can be calculated directly from its measured SINAD using the following formula:

#### EQUATION 8-3:

$$ENOB = \frac{SINAD - 1.76}{6.02}$$

### Gain Error

Gain error is the deviation of the ADC's actual input full-scale range from its ideal value. The gain error is given as a percentage of the ideal input full-scale range. Gain error is usually expressed in LSB or as a percentage of full-scale range (%FSR).

### Offset Error

Offset error is the difference between the ideal voltage ( $0V + 0.5$  LSB) that produces the first code transition ("000... 000" to "000... 001") and the actual voltage producing that code.

### Temperature Drift

The temperature drift for offset error and gain error specifies the maximum change from the initial (+25°C) value to the value at across the  $T_{MIN}$  to  $T_{MAX}$  range. The value is normalized by the reference voltage and expressed in  $\mu V/^\circ C$  or ppm/ $^\circ C$ .

### Maximum Conversion Rate

The maximum clock rate at which parametric testing is performed.

### Spurious-Free Dynamic Range (SFDR)

SFDR is the ratio of the power of the fundamental to the highest other spectral component (either spur or harmonic). SFDR is typically given in units of dBc (dB to carrier) or dBFS.

# MCP33131/MCP33121/MCP33111-XX

---

## Total Harmonic Distortion (THD)

THD is the ratio of the power of the fundamental ( $P_S$ ) to the summed power of the first 13 harmonics ( $P_D$ ).

### EQUATION 8-4:

$$THD = 10\log\left(\frac{P_S}{P_D}\right)$$

THD is typically given in units of dBc (dB to carrier). THD is also shown by:

### EQUATION 8-5:

$$THD = -20\log\frac{\sqrt{V_2^2 + V_3^2 + V_4^2 + \dots + V_n^2}}{V_1^2}$$

Where:

$V_1$  = RMS amplitude of the fundamental frequency

$V_1$  through  $V_n$  = Amplitudes of the second through  $n^{\text{th}}$  harmonics

## Common-Mode Rejection Ratio (CMRR)

Common-mode rejection is the ability of a device to reject a signal that is common to both sides of a differential or pseudo-differential input pair. The common-mode signal can be an AC or DC signal or a combination of the two. CMRR is measured using the ratio of the differential signal gain to the common-mode signal gain and expressed in dB with the following equation:

### EQUATION 8-6:

$$CMRR = 20\log\left(\frac{A_{DIFF}}{A_{CM}}\right)$$

Where:

$A_{DIFF}$  =  $\Delta$ Output Code/ $\Delta$ Differential Voltage

$A_{DIFF}$  =  $\Delta$ Output Code/ $\Delta$ Common-Mode Voltage

# MCP33131/MCP33121/MCP33111-XX

## 9.0 PACKAGING INFORMATION

### 9.1 Package Marking Information

10-Lead MSOP (3x3 mm)

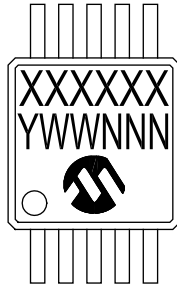

**Corresponding Part Number:**

31-10 = MCP33131-10  
 31-05 = MCP33131-05  
 21-10 = MCP33121-10  
 21-05 = MCP33121-05  
 11-10 = MCP33111-10  
 11-05 = MCP33111-05

Example

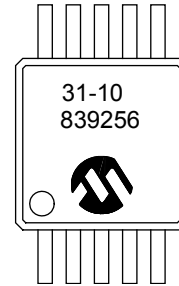

10-Lead TDFN (3x3x0.9 mm)

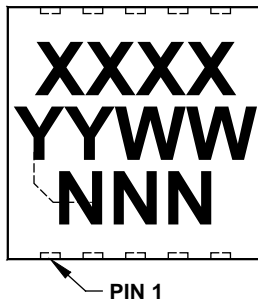

**Corresponding Part Number:**

311 = MCP33131-10  
 310 = MCP33131-05  
 211 = MCP33121-10  
 210 = MCP33121-05  
 111 = MCP33111-10  
 110 = MCP33111-05

Example

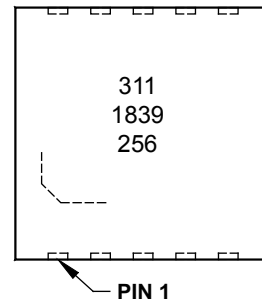

**Legend:** XX...X Customer-specific information  
 Y Year code (last digit of calendar year)  
 YY Year code (last 2 digits of calendar year)  
 WW Week code (week of January 1 is week '01')  
 NNN Alphanumeric traceability code  
 (e3) Pb-free JEDEC® designator for Matte Tin (Sn)  
 \* This package is Pb-free. The Pb-free JEDEC designator (e3) can be found on the outer packaging for this package.

**Note:** In the event the full Microchip part number cannot be marked on one line, it will be carried over to the next line, thus limiting the number of available characters for customer-specific information.

# MCP33131/MCP33121/MCP33111-XX

## 10-Lead Plastic Micro Small Outline Package (MS) [MSOP]

**Note:** For the most current package drawings, please see the Microchip Packaging Specification located at <http://www.microchip.com/packaging>

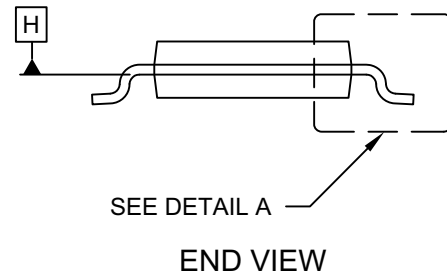
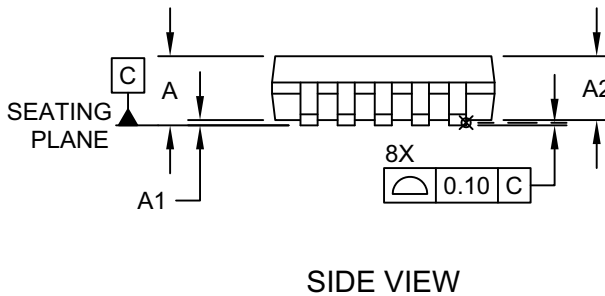
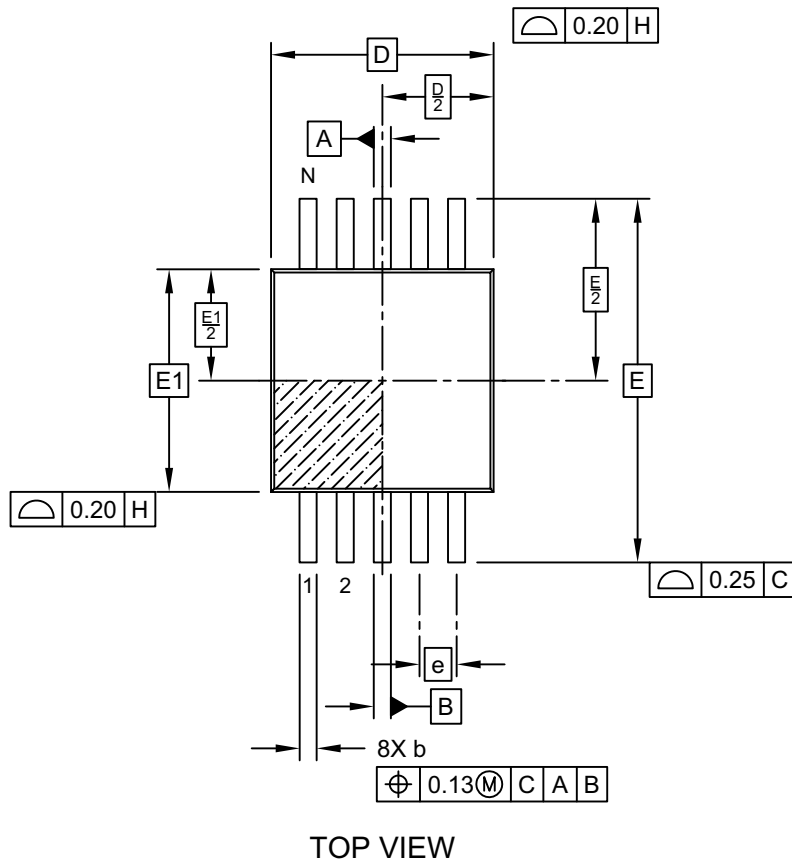

Microchip Technology Drawing C04-021D Sheet 1 of 2

# MCP33131/MCP33121/MCP33111-XX

## 10-Lead Plastic Micro Small Outline Package (MS) [MSOP]

**Note:** For the most current package drawings, please see the Microchip Packaging Specification located at <http://www.microchip.com/packaging>

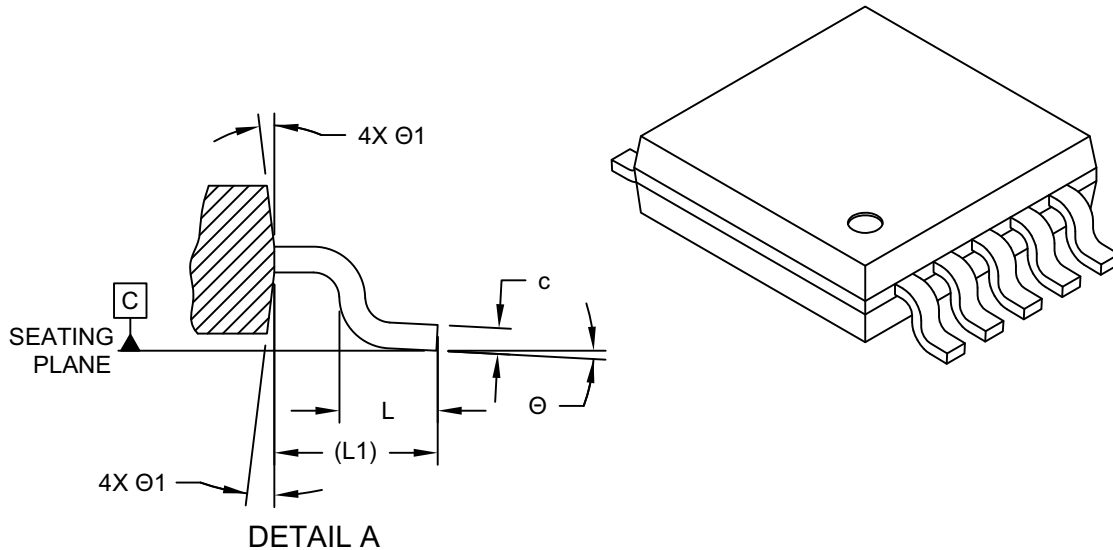

Dimension Limits	Units	MILLIMETERS		
		MIN	NOM	MAX
Number of Pins	N	10		
Pitch	e	0.50 BSC		
Overall Height	A	-	-	1.10
Molded Package Thickness	A2	0.75	0.85	0.95
Standoff	A1	0.00	-	0.15
Overall Width	E	4.90 BSC		
Molded Package Width	E1	3.00 BSC		
Overall Length	D	3.00 BSC		
Foot Length	L	0.40	0.60	0.80
Footprint	L1	0.95 REF		
Mold Draft Angle	Ø	0°	-	8°
Foot Angle	Ø1	5°	-	15°
Lead Thickness	c	0.08	-	0.23
Lead Width	b	0.15	-	0.33

**Notes:**

- Pin 1 visual index feature may vary, but must be located within the hatched area.
- Dimensions D and E1 do not include mold flash or protrusions. Mold flash or protrusions shall not exceed 0.15mm per side.
- Dimensioning and tolerancing per ASME Y14.5M.  
 BSC: Basic Dimension. Theoretically exact value shown without tolerances.  
 REF: Reference Dimension, usually without tolerance, for information purposes only.

Microchip Technology Drawing C04-021D Sheet 2 of 2

# MCP33131/MCP33121/MCP33111-XX

## 10-Lead Plastic Micro Small Outline Package (MS) [MSOP]

**Note:** For the most current package drawings, please see the Microchip Packaging Specification located at <http://www.microchip.com/packaging>

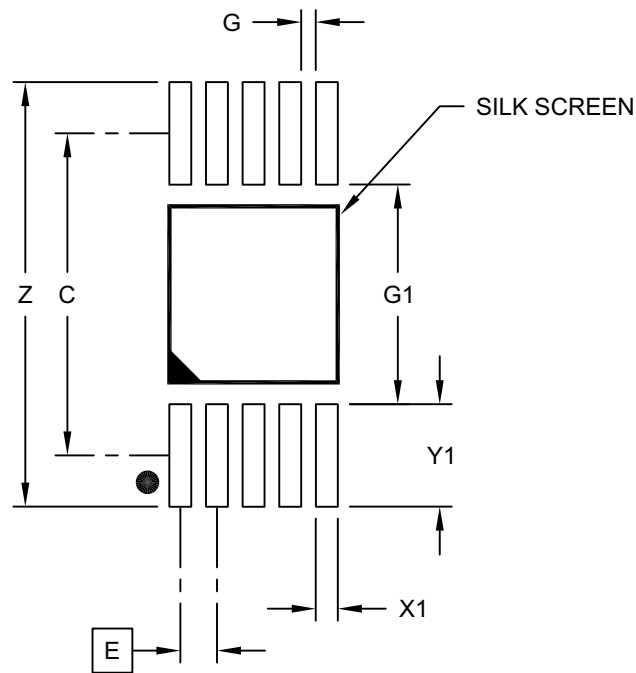

### RECOMMENDED LAND PATTERN

Dimension	Units	MILLIMETERS		
		MIN	NOM	MAX
Contact Pitch	E	0.50 BSC		
Contact Pad Spacing	C		4.40	
Overall Width	Z			5.80
Contact Pad Width (X10)	X1			0.30
Contact Pad Length (X10)	Y1			1.40
Distance Between Pads (X5)	G1	3.00		
Distance Between Pads (X8)	G	0.20		

**Notes:**

1. Dimensioning and tolerancing per ASME Y14.5M  
BSC: Basic Dimension. Theoretically exact value shown without tolerances.

Microchip Technology Drawing No. C04-2021B

# MCP33131/MCP33121/MCP33111-XX

## 10-Lead Thin Plastic Dual Flat, No Lead Package (MN) - 3x3x0.8mm Body [TDFN]

**Note:** For the most current package drawings, please see the Microchip Packaging Specification located at <http://www.microchip.com/packaging>

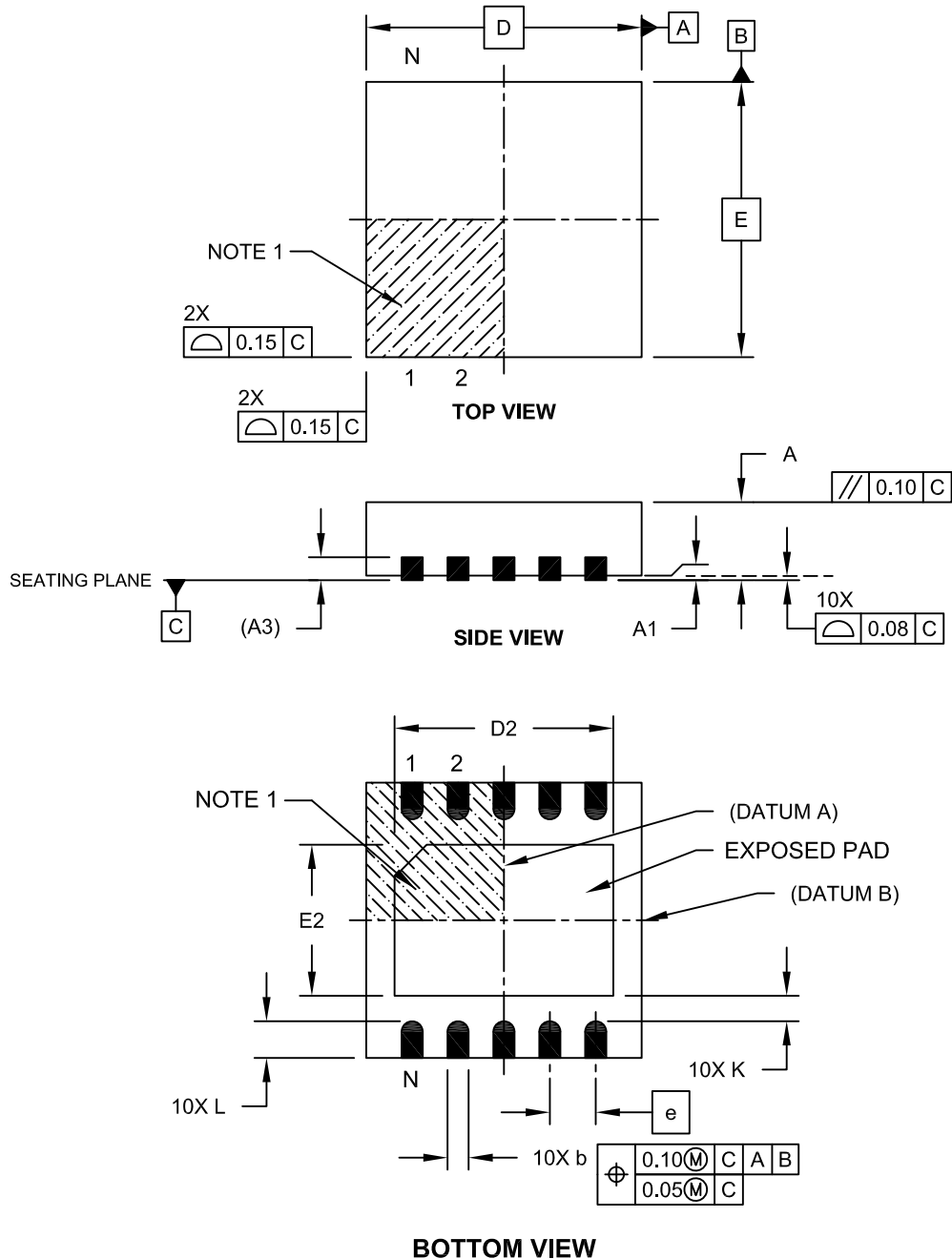

Microchip Technology Drawing C04-185A Sheet 1 of 2

# MCP33131/MCP33121/MCP33111-XX

## 10-Lead Thin Plastic Dual Flat, No Lead Package (MN) - 3x3x0.8mm Body [TDFN]

**Note:** For the most current package drawings, please see the Microchip Packaging Specification located at <http://www.microchip.com/packaging>

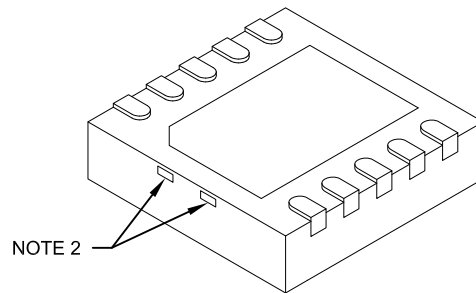

Dimension Limits	Units	MILLIMETERS		
		MIN	NOM	MAX
Number of Pins	N	10		
Pitch	e	0.50 BSC		
Overall Height	A	0.70	0.75	0.80
Standoff	A1	0.00	0.02	0.05
Contact Thickness	A3	0.20 REF		
Overall Length	D	3.00 BSC		
Exposed Pad Length	D2	2.20	2.30	2.35
Overall Width	E	3.00 BSC		
Exposed Pad Width	E2	1.55	1.65	1.70
Contact Width	b	0.18	0.25	0.30
Contact Length	L	0.30	0.40	0.50
Contact-to-Exposed Pad	K	0.20	-	-

**Notes:**

1. Pin 1 visual index feature may vary, but must be located within the hatched area.
2. Package may have one or more exposed tie bars at ends.
3. Package is saw singulated
4. Dimensioning and tolerancing per ASME Y14.5M  
BSC: Basic Dimension. Theoretically exact value shown without tolerances.  
REF: Reference Dimension, usually without tolerance, for information purposes only.

Microchip Technology Drawing No. C04-0185A Sheet 2 of 2



# MCP33131/MCP33121/MCP33111-XX

---

## APPENDIX A: REVISION HISTORY

### Revision A (November 2018)

- Original release of this document.

# MCP33131/MCP33121/MCP33111-XX

---

NOTES:

# MCP33131/MCP33121/MCP33111-XX

## PRODUCT IDENTIFICATION SYSTEM

To order or obtain information, e.g., on pricing or delivery, refer to the factory or the listed sales office.

<u>PART NO.</u>	<u>X</u>	<u>-XX</u>	<u>X</u>	<u>-X</u>	<u>/XX</u>	<b>Examples:</b>
Device	Input Type	Sample Rate	Tape and Reel	Temperature Range	Package	
<b>Device:</b>	MCP33131-10:	1 Msps	16-Bit Single-Ended Input SAR ADC			a) MCP33131-10-I/MS: 1 Msps, 10LD MSOP, 16-bit device
	MCP33121-10:	1 Msps	14-Bit Single-Ended Input SAR ADC			b) MCP33131-10T-I/MS: 1 Msps, 10LD MSOP, Tape and Reel, 16-bit device
	MCP33111-10:	1 Msps	12-Bit Single-Ended Input SAR ADC			c) MCP33131-10-I/MN: 1 Msps, 10LD TDFN, 16-bit device
						d) MCP33131-10T-I/MN: 1 Msps, 10LD TDFN, Tape and Reel, 16-bit device
	MCP33131-05:	500 kSPS	16-Bit Single-Ended Input SAR ADC			e) MCP33121-10-I/MS: 1 Msps, 10LD MSOP, 14-bit device
	MCP33121-05:	500 kSPS	14-Bit Single-Ended Input SAR ADC			f) MCP33121-10T-I/MS: 1 Msps, 10LD MSOP, Tape and Reel, 14-bit device
	MCP33111-05:	500 kSPS	12-Bit Single-Ended Input SAR ADC			g) MCP33121-10-I/MN: 1 Msps, 10LD TDFN, 14-bit device
<b>Input Type</b>	Blank	=	Single-Ended Input			h) MCP33121-10T-I/MN: 1 Msps, 10LD TDFN, Tape and Reel, 14-bit device
<b>Sample Rate:</b>	10	=	1 Msps			i) MCP33111-10-I/MS: 1 Msps, 10LD MSOP, 12-bit device
	05	=	500 kSPS			j) MCP33111-10T-I/MS: 1 Msps, 10LD MSOP, Tape and Reel, 12-bit device
<b>Tape and Reel Option:</b>	Blank	=	Standard packaging (tube or tray)			k) MCP33111-10-I/MN: 1 Msps, 10LD TDFN, 12-bit device
	T	=	Tape and Reel			l) MCP33111-10T-I/MN: 1 Msps, 10LD TDFN, Tape and Reel, 12-bit device
<b>Temperature Range:</b>	E	=	-40°C to +125°C (Extended)			m) MCP33131-05-I/MS: 500 kSPS, 10LD MSOP, 16-bit device
	I	=	-40°C to +85°C (Industrial)			n) MCP33131-05T-I/MS: 500 kSPS, 10LD MSOP, Tape and Reel, 16-bit device
<b>Package:</b>	MS	=	Plastic Micro Small Outline Package (MSOP), 10-Lead			o) MCP33131-05-I/MN: 500 kSPS, 10LD TDFN, 16-bit device
	MN	=	Thin Plastic Dual Flat No Lead Package (TDFN), 10-Lead			p) MCP33131-05T-I/MN: 500 kSPS, 10LD TDFN, Tape and Reel, 16-bit device
						q) MCP33121-05-I/MS: 500 kSPS, 10LD MSOP, 14-bit device
						r) MCP33121-05T-I/MS: 500 kSPS, 10LD MSOP, Tape and Reel, 14-bit device
						s) MCP33121-05-I/MN: 500 kSPS, 10LD TDFN, 14-bit device
						t) MCP33121-05T-I/MN: 500 kSPS, 10LD TDFN, Tape and Reel, 14-bit device
						u) MCP33111-05-I/MS: 500 kSPS, 10LD MSOP, 12-bit device
						v) MCP33111-05T-I/MS: 500 kSPS, 10LD MSOP, Tape and Reel, 12-bit device
						w) MCP33111-05-I/MN: 500 kSPS, 10LD TDFN, 12-bit device
						x) MCP33111-05T-I/MN: 500 kSPS, 10LD TDFN, Tape and Reel, 12-bit device

**Note 1:** Tape and Reel identifier appears only in the catalog part number description. This identifier is used for ordering purposes and is not printed on the device package. Check with your Microchip Sales Office for package availability with the Tape and Reel option.

# MCP33131/MCP33121/MCP33111-XX

---

NOTES:

---

**Note the following details of the code protection feature on Microchip devices:**

- Microchip products meet the specification contained in their particular Microchip Data Sheet.
- Microchip believes that its family of products is one of the most secure families of its kind on the market today, when used in the intended manner and under normal conditions.
- There are dishonest and possibly illegal methods used to breach the code protection feature. All of these methods, to our knowledge, require using the Microchip products in a manner outside the operating specifications contained in Microchip's Data Sheets. Most likely, the person doing so is engaged in theft of intellectual property.
- Microchip is willing to work with the customer who is concerned about the integrity of their code.
- Neither Microchip nor any other semiconductor manufacturer can guarantee the security of their code. Code protection does not mean that we are guaranteeing the product as “unbreakable.”

Code protection is constantly evolving. We at Microchip are committed to continuously improving the code protection features of our products. Attempts to break Microchip's code protection feature may be a violation of the Digital Millennium Copyright Act. If such acts allow unauthorized access to your software or other copyrighted work, you may have a right to sue for relief under that Act.

---

Information contained in this publication regarding device applications and the like is provided only for your convenience and may be superseded by updates. It is your responsibility to ensure that your application meets with your specifications. MICROCHIP MAKES NO REPRESENTATIONS OR WARRANTIES OF ANY KIND WHETHER EXPRESS OR IMPLIED, WRITTEN OR ORAL, STATUTORY OR OTHERWISE, RELATED TO THE INFORMATION, INCLUDING BUT NOT LIMITED TO ITS CONDITION, QUALITY, PERFORMANCE, MERCHANTABILITY OR FITNESS FOR PURPOSE. Microchip disclaims all liability arising from this information and its use. Use of Microchip devices in life support and/or safety applications is entirely at the buyer's risk, and the buyer agrees to defend, indemnify and hold harmless Microchip from any and all damages, claims, suits, or expenses resulting from such use. No licenses are conveyed, implicitly or otherwise, under any Microchip intellectual property rights unless otherwise stated.

*Microchip received ISO/TS-16949:2009 certification for its worldwide headquarters, design and wafer fabrication facilities in Chandler and Tempe, Arizona; Gresham, Oregon and design centers in California and India. The Company's quality system processes and procedures are for its PIC® MCUs and dsPIC® DSCs, KEELOQ® code hopping devices, Serial EEPROMs, microperipherals, nonvolatile memory and analog products. In addition, Microchip's quality system for the design and manufacture of development systems is ISO 9001:2000 certified.*

**QUALITY MANAGEMENT SYSTEM  
CERTIFIED BY DNV  
= ISO/TS 16949 =**

**Trademarks**

The Microchip name and logo, the Microchip logo, AnyRate, AVR, AVR logo, AVR Freaks, BeaconThings, BitCloud, chipKIT, chipKIT logo, CryptoMemory, CryptoRF, dsPIC, FlashFlex, flexPWR, Helder, JukeBlox, KEELOQ, KEELOQ logo, Kleer, LANCheck, LINK MD, maXStylus, maXTouch, MedialB, megaAVR, MOST, MOST logo, MPLAB, OptoLyzer, PIC, picoPower, PICSTART, PIC32 logo, Prochip Designer, QTouch, RightTouch, SAM-BA, SpyNIC, SST, SST Logo, SuperFlash, tinyAVR, UNI/O, and XMEGA are registered trademarks of Microchip Technology Incorporated in the U.S.A. and other countries.

ClockWorks, The Embedded Control Solutions Company, EtherSynch, Hyper Speed Control, HyperLight Load, IntelliMOS, mTouch, Precision Edge, and Quiet-Wire are registered trademarks of Microchip Technology Incorporated in the U.S.A.

Adjacent Key Suppression, AKS, Analog-for-the-Digital Age, Any Capacitor, AnyIn, AnyOut, BodyCom, CodeGuard, CryptoAuthentication, CryptoCompanion, CryptoController, dsPICDEM, dsPICDEM.net, Dynamic Average Matching, DAM, ECAN, EtherGREEN, In-Circuit Serial Programming, ICSP, Inter-Chip Connectivity, JitterBlocker, KleerNet, KleerNet logo, Mindi, MiWi, motorBench, MPASM, MPF, MPLAB Certified logo, MPLIB, MPLINK, MultiTRAK, NetDetach, Omniscient Code Generation, PICDEM, PICDEM.net, PICKit, PICTail, PureSilicon, QMatrix, RightTouch logo, REAL ICE, Ripple Blocker, SAM-ICE, Serial Quad I/O, SMART-I.S., SQI, SuperSwitcher, SuperSwitcher II, Total Endurance, TSHARC, USBCheck, VariSense, ViewSpan, WiperLock, Wireless DNA, and ZENA are trademarks of Microchip Technology Incorporated in the U.S.A. and other countries.

SQTP is a service mark of Microchip Technology Incorporated in the U.S.A.

Silicon Storage Technology is a registered trademark of Microchip Technology Inc. in other countries.

GestIC is a registered trademark of Microchip Technology Germany II GmbH & Co. KG, a subsidiary of Microchip Technology Inc., in other countries.

All other trademarks mentioned herein are property of their respective companies.

© 2018, Microchip Technology Incorporated, All Rights Reserved.

ISBN: 978-1-5224-3911-0



# MICROCHIP

## Worldwide Sales and Service

### AMERICAS

**Corporate Office**  
2355 West Chandler Blvd.  
Chandler, AZ 85224-6199  
Tel: 480-792-7200  
Fax: 480-792-7277  
Technical Support:  
<http://www.microchip.com/support>  
Web Address:  
[www.microchip.com](http://www.microchip.com)

#### Atlanta

Duluth, GA  
Tel: 678-957-9614  
Fax: 678-957-1455

#### Austin, TX

Tel: 512-257-3370

#### Boston

Westborough, MA  
Tel: 774-760-0087  
Fax: 774-760-0088

#### Chicago

Itasca, IL  
Tel: 630-285-0071  
Fax: 630-285-0075

#### Dallas

Addison, TX  
Tel: 972-818-7423  
Fax: 972-818-2924

#### Detroit

Novi, MI  
Tel: 248-848-4000

#### Houston, TX

Tel: 281-894-5983

#### Indianapolis

Noblesville, IN  
Tel: 317-773-8323  
Fax: 317-773-5453  
Tel: 317-536-2380

#### Los Angeles

Mission Viejo, CA  
Tel: 949-462-9523  
Fax: 949-462-9608  
Tel: 951-273-7800

#### Raleigh, NC

Tel: 919-844-7510

#### New York, NY

Tel: 631-435-6000

#### San Jose, CA

Tel: 408-735-9110  
Tel: 408-436-4270

#### Canada - Toronto

Tel: 905-695-1980  
Fax: 905-695-2078

### ASIA/PACIFIC

**Australia - Sydney**  
Tel: 61-2-9868-6733

**China - Beijing**  
Tel: 86-10-8569-7000

**China - Chengdu**  
Tel: 86-28-8665-5511

**China - Chongqing**  
Tel: 86-23-8980-9588

**China - Dongguan**  
Tel: 86-769-8702-9880

**China - Guangzhou**  
Tel: 86-20-8755-8029

**China - Hangzhou**  
Tel: 86-571-8792-8115

**China - Hong Kong SAR**  
Tel: 852-2943-5100

**China - Nanjing**  
Tel: 86-25-8473-2460

**China - Qingdao**  
Tel: 86-532-8502-7355

**China - Shanghai**  
Tel: 86-21-3326-8000

**China - Shenyang**  
Tel: 86-24-2334-2829

**China - Shenzhen**  
Tel: 86-755-8864-2200

**China - Suzhou**  
Tel: 86-186-6233-1526

**China - Wuhan**  
Tel: 86-27-5980-5300

**China - Xian**  
Tel: 86-29-8833-7252

**China - Xiamen**  
Tel: 86-592-2388138

**China - Zhuhai**  
Tel: 86-756-3210040

### ASIA/PACIFIC

**India - Bangalore**  
Tel: 91-80-3090-4444

**India - New Delhi**  
Tel: 91-11-4160-8631

**India - Pune**  
Tel: 91-20-4121-0141

**Japan - Osaka**  
Tel: 81-6-6152-7160

**Japan - Tokyo**  
Tel: 81-3-6880-3770

**Korea - Daegu**  
Tel: 82-53-744-4301

**Korea - Seoul**  
Tel: 82-2-554-7200

**Malaysia - Kuala Lumpur**  
Tel: 60-3-7651-7906

**Malaysia - Penang**  
Tel: 60-4-227-8870

**Philippines - Manila**  
Tel: 63-2-634-9065

**Singapore**  
Tel: 65-6334-8870

**Taiwan - Hsin Chu**  
Tel: 886-3-577-8366

**Taiwan - Kaohsiung**  
Tel: 886-7-213-7830

**Taiwan - Taipei**  
Tel: 886-2-2508-8600

**Thailand - Bangkok**  
Tel: 66-2-694-1351

**Vietnam - Ho Chi Minh**  
Tel: 84-28-5448-2100

### EUROPE

**Austria - Wels**  
Tel: 43-7242-2244-39  
Fax: 43-7242-2244-393

**Denmark - Copenhagen**  
Tel: 45-4450-2828  
Fax: 45-4485-2829

**Finland - Espoo**  
Tel: 358-9-4520-820

**France - Paris**  
Tel: 33-1-69-53-63-20  
Fax: 33-1-69-30-90-79

**Germany - Garching**  
Tel: 49-8931-9700

**Germany - Haan**  
Tel: 49-2129-3766400

**Germany - Heilbronn**  
Tel: 49-7131-67-3636

**Germany - Karlsruhe**  
Tel: 49-721-625370

**Germany - Munich**  
Tel: 49-89-627-144-0  
Fax: 49-89-627-144-44

**Germany - Rosenheim**  
Tel: 49-8031-354-560

**Israel - Ra'anana**  
Tel: 972-9-744-7705

**Italy - Milan**  
Tel: 39-0331-742611  
Fax: 39-0331-466781

**Italy - Padova**  
Tel: 39-049-7625286

**Netherlands - Drunen**  
Tel: 31-416-690399  
Fax: 31-416-690340

**Norway - Trondheim**  
Tel: 47-7289-7561

**Poland - Warsaw**  
Tel: 48-22-3325737

**Romania - Bucharest**  
Tel: 40-21-407-87-50

**Spain - Madrid**  
Tel: 34-91-708-08-90  
Fax: 34-91-708-08-91

**Sweden - Gothenberg**  
Tel: 46-31-704-60-40

**Sweden - Stockholm**  
Tel: 46-8-5090-4654

**UK - Wokingham**  
Tel: 44-118-921-5800  
Fax: 44-118-921-5820

# Mouser Electronics

Authorized Distributor

Click to View Pricing, Inventory, Delivery & Lifecycle Information:

## Microchip:

[MCP33111-05-E/MN](#) [MCP33121-10-E/MN](#) [MCP33121-05-E/MN](#) [MCP33131-05-E/MS](#) [MCP33131-10-E/MN](#)  
[MCP33131-05-E/MN](#) [MCP33121-05-E/MS](#) [MCP33111-05-E/MS](#) [MCP33111-10-E/MN](#) [MCP33111-10-E/MS](#)  
[MCP33121-10-E/MS](#) [MCP33111-10T-E/MS](#) [MCP33131-10-E/MS](#)