

SUPER LOW ON RESISTANCE / LOW VOLTAGE 1A LDO

NO.EA-122-130924

OUTLINE

The R1172x Series are CMOS-based positive voltage regulator ICs. The R1172x Series have features of super low dropout, 1A output current capability. Even the output voltage is set at 1.5V, on resistance of internal FET is typically 0.32Ω. Therefore, applications that require a large current at small dropout are suitable for the R1172x series. Low input voltage is acceptable and low output voltage can be set. The minimum input voltage is 1.4V, and the lowest set output voltage is 0.8V. Each of these ICs consists of a voltage reference unit, an error amplifier, resistor net for setting output voltage, a current limit circuit at over-current, a chip enable circuit, a thermal-shutdown circuit, and so on. A stand-by mode with ultra low consumption current can be realized with the chip enable pin. The output voltage of R1172 is fixed in the IC.

Since the packages for these ICs are SOT-23-5, SOT-89-5, HSON-6, and HSOP-6J with high power dissipation, high density mounting of the ICs on boards is possible.

FEATURES

- Output Current 1A
- Supply Current Typ. 60μA
- Standby Current Typ. 0.1μA
- Input Voltage Range 1.4V to 6.0V
- Output Voltage..... 0.8V to 5.0V (0.1V steps)
(For other voltages, please refer to MARK INFORMATION.)
- Dropout Voltage..... Typ. 0.32V (V_{OUT}=1.5V, I_{OUT}=1A)
Typ. 0.18V (V_{OUT}=2.8V, I_{OUT}=1A)
- Ripple Rejection Typ. 70dB (V_{OUT}=2.8V)
- Output Voltage Accuracy ±2.0%
- Temperature-Drift Coefficient of Output Voltage Typ. ±100ppm/°C
- Line Regulation Typ. 0.05%/V
- Load Regulation Typ. 15mV at I_{OUT}=300mA, Typ. 50mV at I_{OUT}=1A
- Packages SOT-23-5, SOT-89-5, HSON-6, HSOP-6J
- Built-in Inrush current limit circuit Typ. 500 mA
- Built-in Fold-Back Protection Circuit Typ. 250mA (Current at short mode)
- Built-in Thermal Shutdown Circuit Thermal Shutdown Temperature ; Typ. 150°C
Released Temperature ; Typ. 120°C
- Built-in Auto Discharge Function D Version
- Output capacitors C_{IN}=C_{OUT}=Tantalum 4.7μF (V_{OUT} < 1.0V)
C_{IN}=C_{OUT}=Ceramic 4.7μF (V_{OUT} ≥ 1.0V)

APPLICATIONS

- Local Power source for Notebook PC.
- Local Power source for portable communication equipments, cameras, and VCRs.
- Local Power source for home appliances.

BLOCK DIAGRAMS

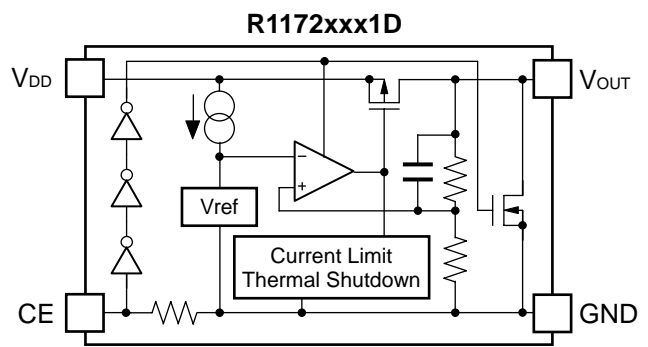
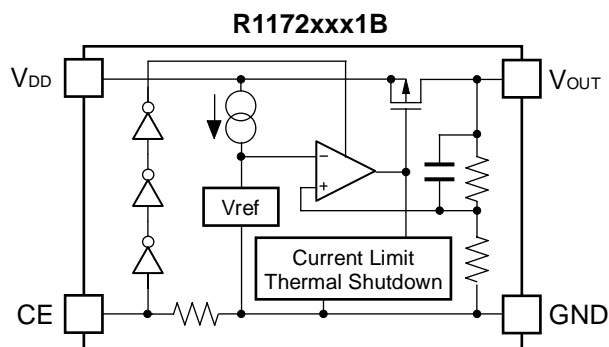
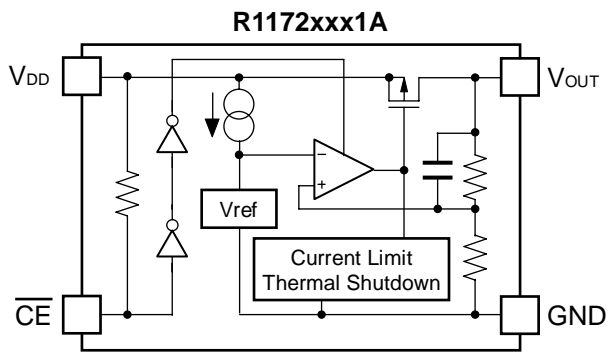

SELECTION GUIDE

The output voltage, chip-enable polarity, auto discharge function, and package for the ICs can be selected at the user's request.

| Product Name | Package | Quantity per Reel | Pb Free | Halogen Free |
|------------------|----------|-------------------|---------|--------------|
| R1172Nxx1*-TR-FE | SOT-23-5 | 3,000 pcs | Yes | Yes |
| R1172Hxx1*-T1-FE | SOT-89-5 | 1,000 pcs | Yes | Yes |
| R1172Dxx1*-TR-FE | HSOP-6 | 3,000 pcs | Yes | Yes |
| R1172Sxx1*-E2-FE | HSOP-6J | 1,000 pcs | Yes | Yes |

xx: The output voltage can be designated in the range from 0.8V(08) to 5.0V(50) in 0.1V steps.
 (HSOP-6J : 0.8V to 3.5V)
 (For other voltages, please refer to MARK INFORMATIONS.)

* : CE pin polarity and auto discharge function at off state are options as follows.
 (A) "L" active, without auto discharge function at off state
 (B) "H" active, without auto discharge function at off state
 (D) "H" active, with auto discharge function at off state

PIN CONFIGURATIONS

● SOT-23-5

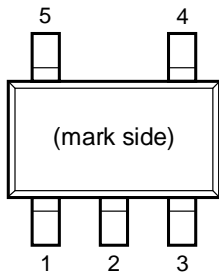

● SOT-89-5

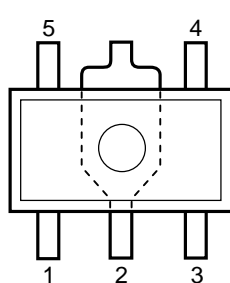

● HSON-6

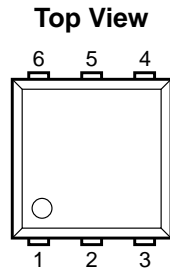

Bottom View

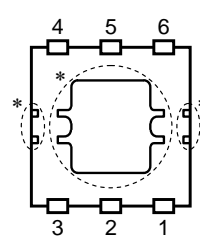

● HSOP-6J

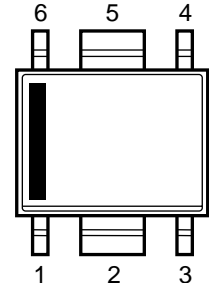

PIN DESCRIPTIONS

● SOT-23-5

| Pin No. | Symbol | Description |
|---------|-----------------------|------------------------------|
| 1 | V_{OUT} | Voltage Regulator Output Pin |
| 2 | GND | Ground Pin |
| 3 | V_{DD} | Input Pin |
| 4 | NC | No Connection |
| 5 | \overline{CE} or CE | Chip Enable Pin |

● SOT-89-5

| Pin No. | Symbol | Description |
|---------|-----------------------|------------------------------|
| 1 | \overline{CE} or CE | Chip Enable Pin |
| 2 | GND | Ground Pin |
| 3 | NC | No Connection |
| 4 | V_{DD} | Input Pin |
| 5 | V_{OUT} | Voltage Regulator Output Pin |

● HSON-6

| Pin No. | Symbol | Description |
|---------|-----------------------|------------------------------|
| 1 | V_{OUT}^{*1} | Voltage Regulator Output Pin |
| 2 | V_{OUT}^{*1} | Voltage Regulator Output Pin |
| 3 | \overline{CE} or CE | Chip Enable Pin |
| 4 | GND | Ground Pin |
| 5 | V_{DD}^{*1} | Input Pin |
| 6 | V_{DD}^{*1} | Input Pin |

*) Tab and tab suspension leads in the  parts are GND level.
(They are connected to the reverse side of the IC.)

The tab is better to be connected to the GND, but leaving it open is also acceptable.

The tab suspension leads should be open and do not connect to other wires or land patterns.

*1) The V_{OUT} pin and V_{DD} pin must be wired each other when it is mounted on board.

• HSOP-6J

| Pin No. | Symbol | Description |
|---------|-----------------------|------------------------------|
| 1 | V _{OUT} | Voltage Regulator Output Pin |
| 2 | GND*1 | Ground Pin |
| 3 | \overline{CE} or CE | Chip Enable Pin |
| 4 | NC | No Connection |
| 5 | GND*1 | Ground Pin |
| 6 | V _{DD} | Input Pin |

*1) The GND pin must be wired together when it is mounted on board.

ABSOLUTE MAXIMUM RATINGS

| Symbol | Item | Rating | Unit |
|------------------|--|------------------------------|------|
| V _{IN} | Input Voltage | 6.5 | V |
| V _{CE} | Input Voltage (\overline{CE} or CE Input Pin) | -0.3 to 6.5 | V |
| V _{OUT} | Output Voltage | -0.3 to V _{IN} +0.3 | V |
| P _D | Power Dissipation (SOT-23-5) * | 420 | mW |
| | Power Dissipation (SOT-89-5) * | 900 | |
| | Power Dissipation (HSOP-6) * | 900 | |
| | Power Dissipation (HSOP-6J) * | 1700 | |
| T _{opt} | Operating Temperature Range | -40 to 85 | °C |
| T _{stg} | Storage Temperature Range | -55 to 125 | °C |

*) For Power Dissipation, please refer to PACKAGE INFORMATION.

ABSOLUTE MAXIMUM RATINGS

Electronic and mechanical stress momentarily exceeded absolute maximum ratings may cause the permanent damages and may degrade the life time and safety for both device and system using the device in the field.

The functional operation at or over these absolute maximum ratings is not assured.

RECOMMENDED OPERATING CONDITIONS (ELECTRICAL CHARACTERISTICS)

All of electronic equipment should be designed that the mounted semiconductor devices operate within the recommended operating conditions. The semiconductor devices cannot operate normally over the recommended operating conditions, even if when they are used over such conditions by momentary electronic noise or surge. And the semiconductor devices may receive serious damage when they continue to operate over the recommended operating conditions.

ELECTRICAL CHARACTERISTICS

• R1172xxx1A

T_{opt}=25°C

| Symbol | Item | Conditions | Min. | Typ. | Max. | Unit |
|--|--|--|----------------------------------|----------|-------|--------|
| V _{IN} | Input Voltage | | 1.4 | | 6.0 | V |
| I _{SS} | Supply Current | V _{IN} -V _{OUT} =1.0V, V _{CE} =0V, I _{OUT} =0A | | 60 | 100 | μA |
| I _{standby} | Standby Current | V _{IN} = 6.0V, V _{CE} =V _{IN} | | 0.1 | 1.0 | μA |
| V _{OUT} | Output Voltage | V _{IN} -V _{OUT} =1.0V I _{OUT} =100mA | V _{OUT} > 1.5V ×0.98 | | ×1.02 | V |
| | | | V _{OUT} ≤ 1.5V -30 | | +30 | mV |
| ΔV _{OUT} / ΔI _{OUT} | Load Regulation | V _{IN} -V _{OUT} =0.3V 1mA ≤ I _{OUT} ≤ 300mA If V _{OUT} ≤ 1.1V, then V _{IN} =1.4V | -15 | 15 | 30 | mV |
| | | V _{IN} -V _{OUT} =0.3V 1mA ≤ I _{OUT} ≤ 1A If V _{OUT} ≤ 1.1V, then V _{IN} =1.7V | | 50 | | |
| V _{DIF} | Dropout Voltage | Refer to Dropout Voltage Table | | | | |
| ΔV _{OUT} / ΔV _{IN} | Line Regulation | I _{OUT} =100mA V _{OUT} +0.5V ≤ V _{IN} ≤ 6.0V If V _{OUT} ≤ 0.9V, 1.4V ≤ V _{IN} ≤ 6.0V | | 0.05 | 0.20 | %/V |
| RR | Ripple Rejection | f=1kHz (V _{OUT} ≤ 4.0V) f=1kHz (V _{OUT} > 4.0V) Ripple 0.5Vp-p, V _{IN} -V _{OUT} =1.0V, I _{OUT} =100mA If V _{OUT} ≤ 1.2V, V _{IN} -V _{OUT} =1.5V, I _{OUT} =100mA | | 70 60 | | dB |
| ΔV _{OUT} / ΔT _{opt} | Output Voltage Temperature Coefficient | I _{OUT} =100mA -40°C ≤ T _{opt} ≤ 85°C | | ±100 | | ppm/°C |
| I _{LIM} | Output Current | V _{IN} -V _{OUT} =1.0V | 1 | | | A |
| I _{SC} | Short Current Limit | V _{OUT} =0V | | 250 | | mA |
| R _{PU} | Pull-up Resistance for \overline{CE} pin | | 1.9 | 5.0 | 15.0 | MΩ |
| V _{CEH} | \overline{CE} Input Voltage "H" | | 1.0 | | 6.0 | V |
| V _{CEL} | \overline{CE} Input Voltage "L" | | 0 | | 0.4 | V |
| T _{TSD} | Thermal Shutdown Temperature | Junction Temperature | | 150 | | °C |
| T _{TSR} | Thermal Shutdown Released Temperature | Junction Temperature | | 120 | | °C |
| en | Output Noise | BW=10Hz to 100kHz | | 30 | | μVrms |

R1172x

• R1172xxx1B/D

T_{opt}=25°C

| Symbol | Item | Conditions | Min. | Typ. | Max. | Unit |
|--|---|---|----------------------------------|----------|-------|--------|
| V _{IN} | Input Voltage | | 1.4 | | 6.0 | V |
| I _{SS} | Supply Current | V _{IN} -V _{OUT} =1.0V, V _{IN} =V _{CE} , I _{OUT} =0A | | 60 | 100 | μA |
| I _{standby} | Standby Current | V _{IN} = 6.0V, V _{CE} =0V | | 0.1 | 1.0 | μA |
| V _{OUT} | Output Voltage | V _{IN} -V _{OUT} =1.0V I _{OUT} =100mA | V _{OUT} > 1.5V ×0.98 | | ×1.02 | V |
| | | | V _{OUT} ≤ 1.5V -30 | | +30 | mV |
| ΔV _{OUT} / ΔI _{OUT} | Load Regulation | V _{IN} -V _{OUT} =0.3V 1mA ≤ I _{OUT} ≤ 300mA If V _{OUT} ≤ 1.1V, then V _{IN} =1.4V | -15 | 15 | 30 | mV |
| | | V _{IN} -V _{OUT} =0.3V 1mA ≤ I _{OUT} ≤ 1A If V _{OUT} ≤ 1.1V, then V _{IN} =1.7V | | 50 | | |
| V _{DIF} | Dropout Voltage | Refer to Dropout Voltage Table | | | | |
| ΔV _{OUT} / ΔV _{IN} | Line Regulation | I _{OUT} =100mA V _{OUT} +0.5V ≤ V _{IN} ≤ 6.0V If V _{OUT} ≤ 0.9V, 1.4V ≤ V _{IN} ≤ 6.0V | | 0.05 | 0.20 | %/V |
| RR | Ripple Rejection | f=1kHz (V _{OUT} ≤ 4.0V) f=1kHz (V _{OUT} > 4.0V) Ripple 0.5Vp-p, V _{IN} -V _{OUT} =1.0V I _{OUT} =100mA If V _{OUT} ≤ 1.2V, V _{IN} -V _{OUT} =1.5V, I _{OUT} =100mA | | 70 60 | | dB |
| ΔV _{OUT} / ΔT _{opt} | Output Voltage Temperature Coefficient | I _{OUT} =100mA -40°C ≤ T _{opt} ≤ 85°C | | ±100 | | ppm/°C |
| I _{LIM} | Output Current | V _{IN} -V _{OUT} =1.0V | 1 | | | A |
| I _{SC} | Short Current Limit | V _{OUT} =0V | | 250 | | mA |
| R _{PD} | Pull-down Resistance for CE pin | | 1.9 | 5.0 | 15.0 | MΩ |
| V _{CEH} | CE Input Voltage "H" | | 1.0 | | 6.0 | V |
| V _{CEL} | CE Input Voltage "L" | | 0 | | 0.4 | V |
| T _{TSD} | Thermal Shutdown Temperature | Junction Temperature | | 150 | | °C |
| T _{TSR} | Thermal Shutdown Released Temperature | Junction Temperature | | 120 | | °C |
| en | Output Noise | BW=10Hz to 100kHz | | 30 | | μVrms |

• Dropout Voltage by Output Voltage

T_{opt}=25°C

| Output Voltage V _{OUT} (V) | Dropout Voltage V _{DIF} (V) | | |
|--|--------------------------------------|------|----------------------|
| | I _{OUT} =300mA | | I _{OUT} =1A |
| | Typ. | Max. | Typ. |
| 0.8 ≤ V _{OUT} < 0.9 | 0.33 | 0.57 | 0.72 |
| 0.9 ≤ V _{OUT} < 1.0 | 0.22 | 0.47 | 0.64 |
| 1.0 ≤ V _{OUT} < 1.5 | 0.18 | 0.32 | 0.56 |
| 1.5 ≤ V _{OUT} < 2.6 | 0.10 | 0.15 | 0.32 |
| 2.6 ≤ V _{OUT} | 0.05 | 0.10 | 0.18 |

TYPICAL APPLICATION (R1172xxx1B/D)

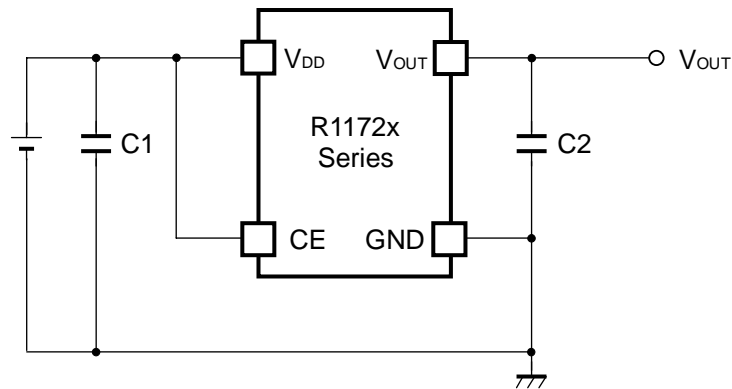

TECHNICAL NOTES

When using these ICs, consider the following points:

Phase Compensation

In these ICs, phase compensation is made for securing stable operation even if the load current is varied. For this purpose, use a capacitor C2 with good frequency characteristics and ESR (Equivalent Series Resistance).

The recommendation value is as follows.

| Output Voltage | C2 recommendation value | Components Recommendation | |
|------------------------------|------------------------------|---|--|
| $V_{OUT} < 1.0V$ | Tantalum 4.7 μ F or more | | |
| $1.0 \leq V_{OUT} \leq 3.3V$ | Ceramic 4.7 μ F or more | Kyocera 4.7 μ F (1608) Murata 4.7 μ F (1608) Murata 10 μ F (1608) | Part Number : CM105X5R475M06AB Part Number : GRM188R60J475KE19B Part Number : GRM188B30G106ME46B |
| $3.3V < V_{OUT}$ | Ceramic 4.7 μ F or more | Kyocera 4.7 μ F (thin 2012) Murata 10 μ F (2012) | Part Number : CT21X5R475M06AB Part Number : GRM21BB30J106K |

* If you use a tantalum type capacitor and ESR value of the capacitor is large, output might be unstable. Evaluate your circuit with considering frequency characteristics.

* Depending on the capacitor size, manufacturer, and part number, the bias characteristics and temperature characteristics are different. Evaluate the circuit with actual using capacitors.

PCB Layout

Make V_{DD} and GND lines sufficient. If their impedance is high, noise pickup or unstable operation may result. Connect a capacitor C1 with a capacitance value as much as 4.7 μ F or more between V_{DD} and GND pin, and as close as possible to the pins.

Set external components, especially the output capacitor C2, as close as possible to the ICs, and make wiring as short as possible.

TYPICAL CHARACTERISTICS

1) Output Voltage vs. Output Current (T_{opt}=25°C)

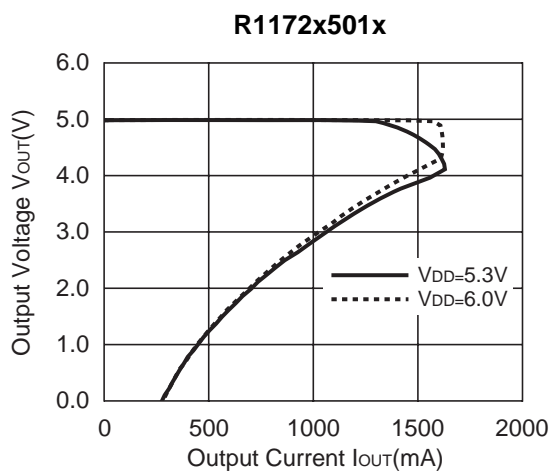
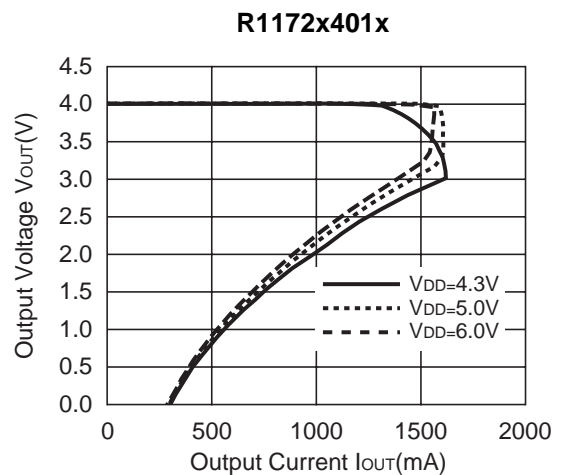
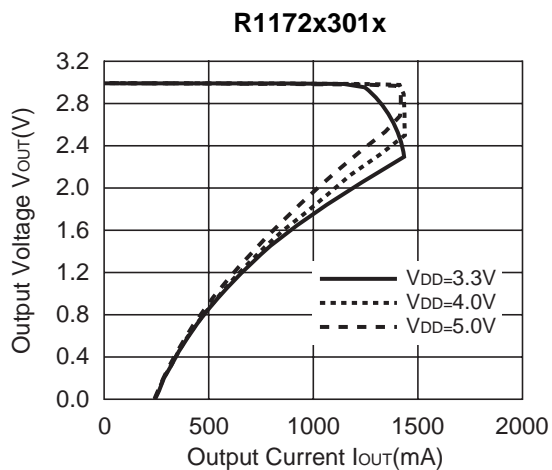
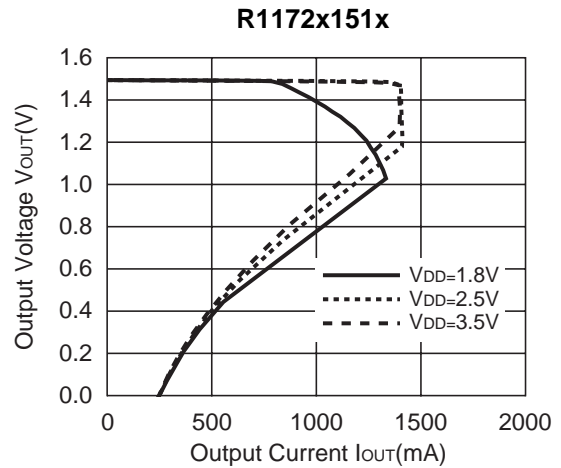
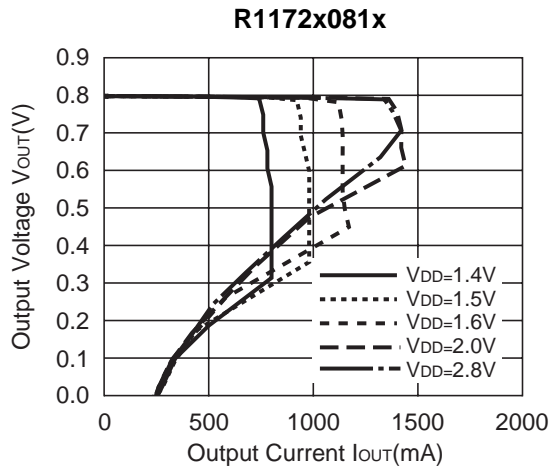

2) Output Voltage vs. Input Voltage (T_{opt}=25°C)

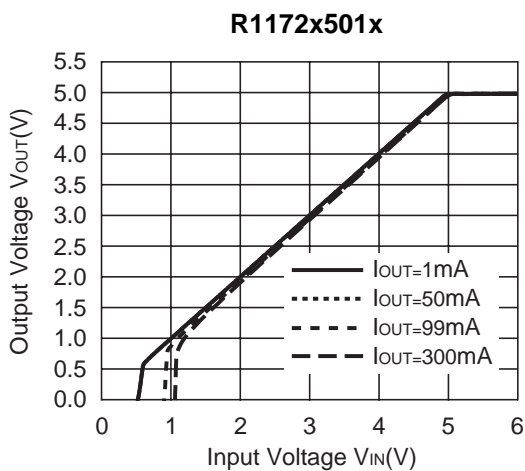
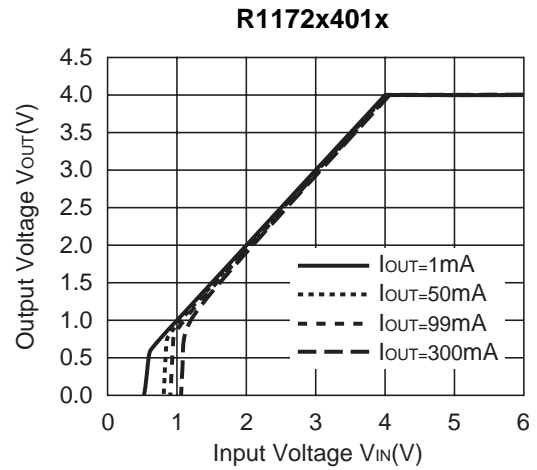
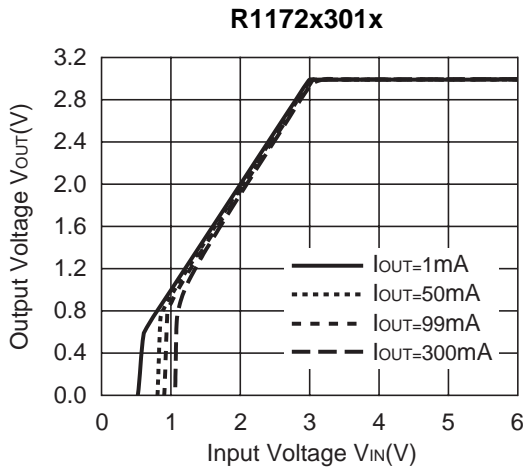
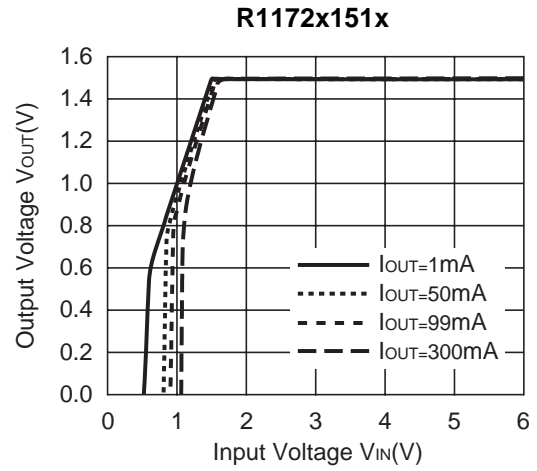
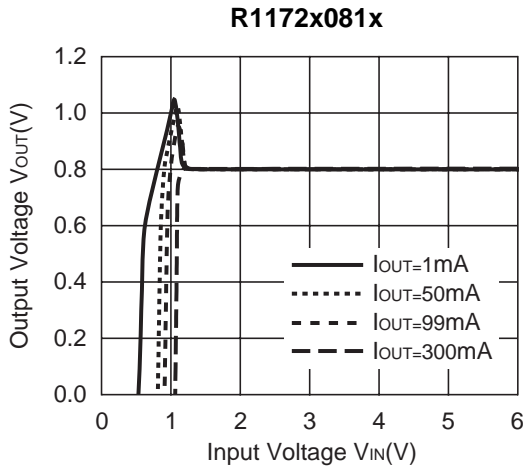

3) Supply Current vs. Input Current ($T_{opt}=25^{\circ}\text{C}$)

R1172x081x

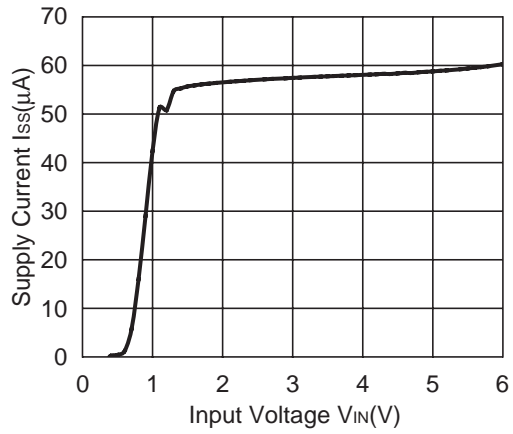

R1172x151x

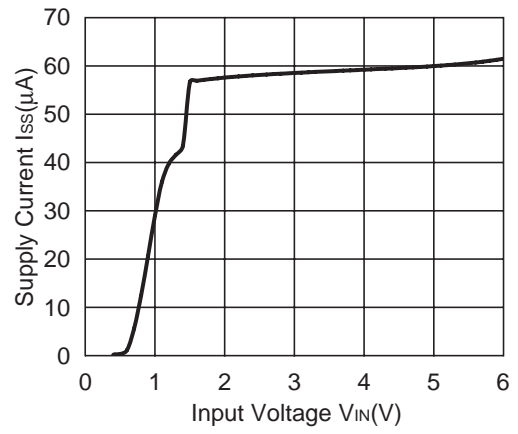

R1172x301x

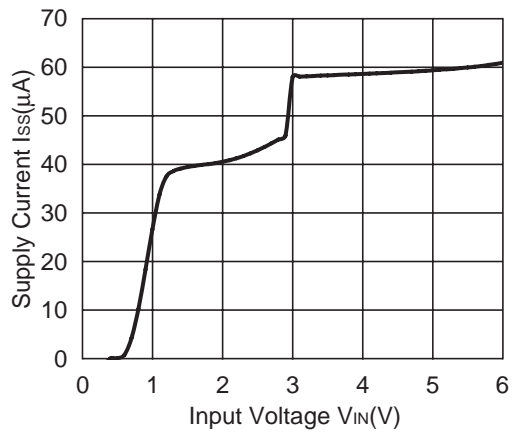

R1172x401x

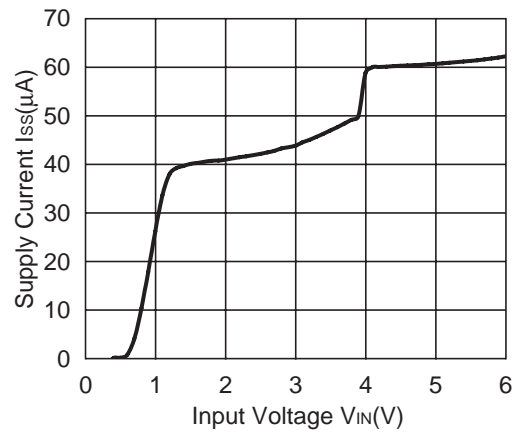

R1172x501x

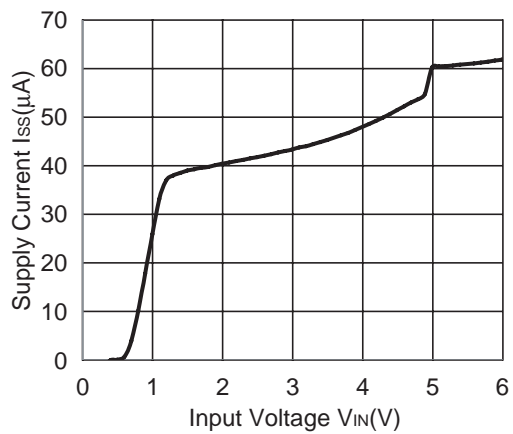

4) Output Voltage vs. Temperature ($I_{OUT}=100mA$)

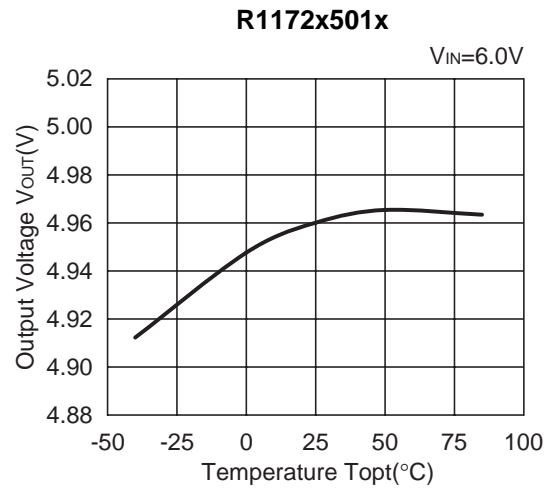
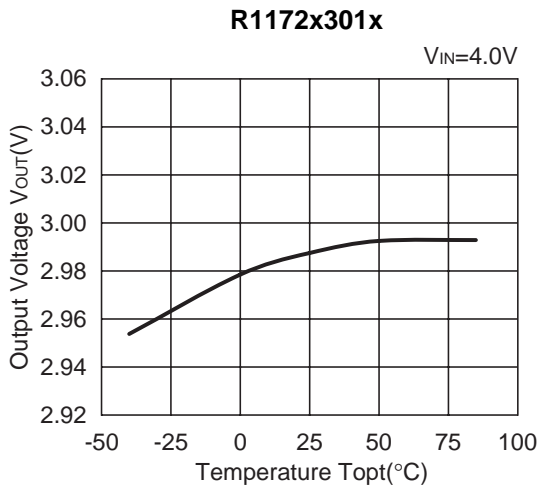
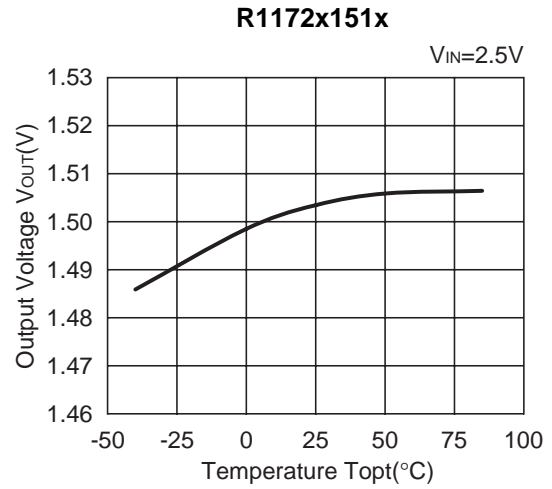
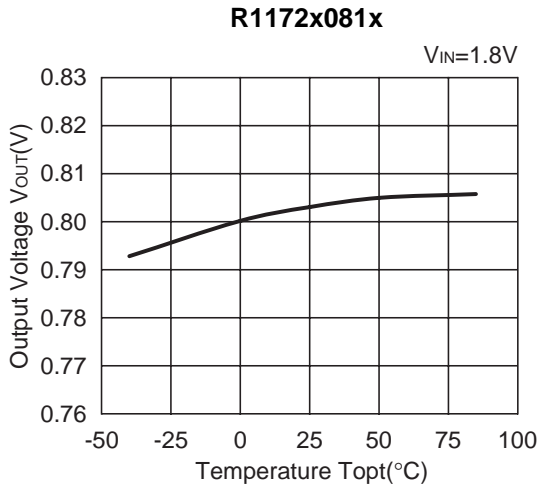

5) Supply Current vs. Temperature

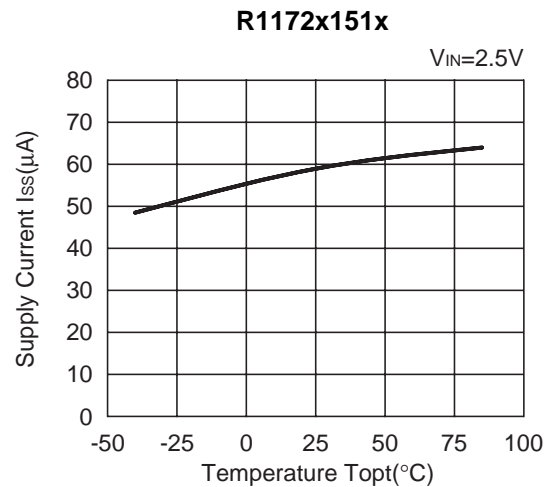
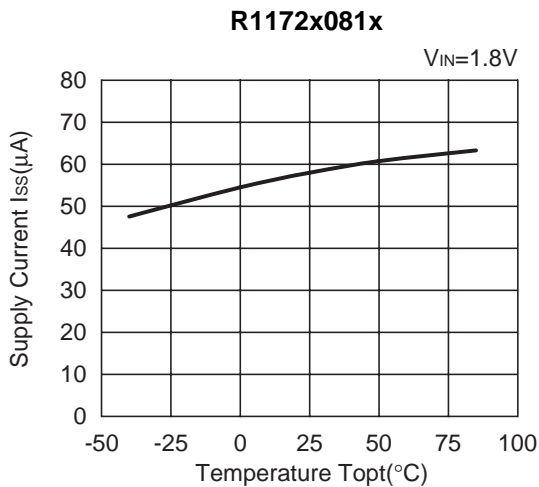

R1172x301x

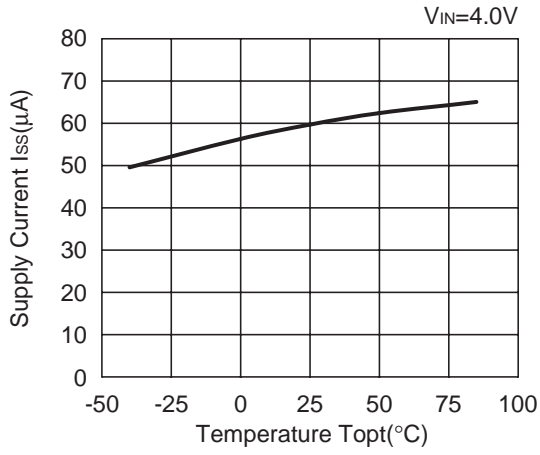

R1172x501x

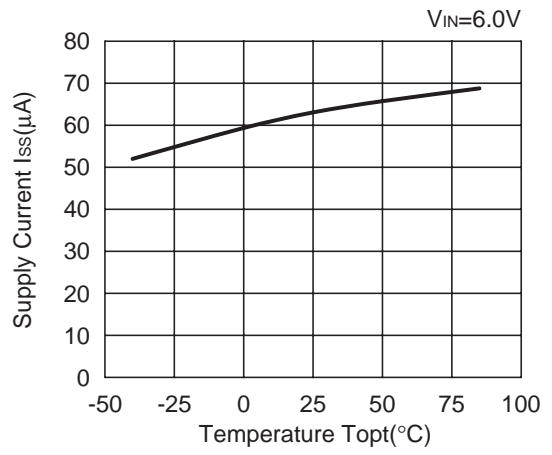

6) Dropout Voltage vs. Output Current

R1172x081x

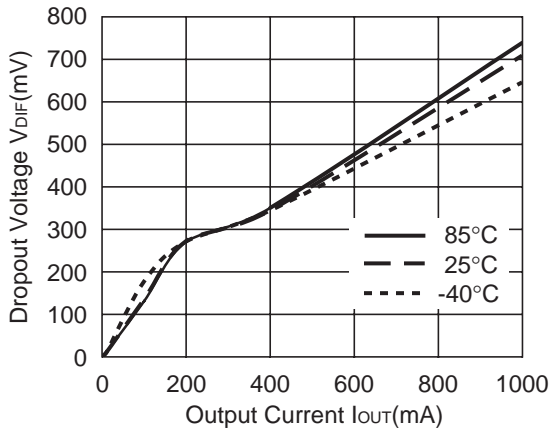

R1172x091x

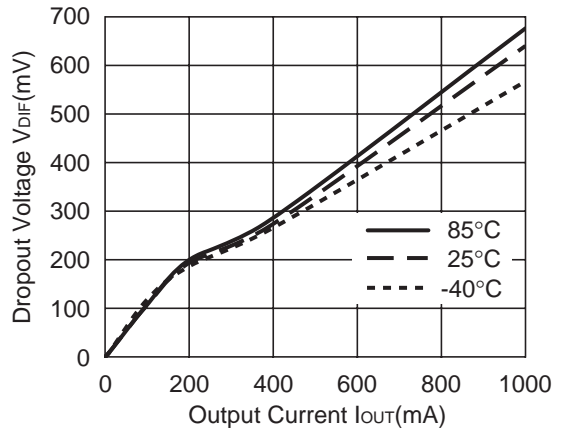

R1172x101x

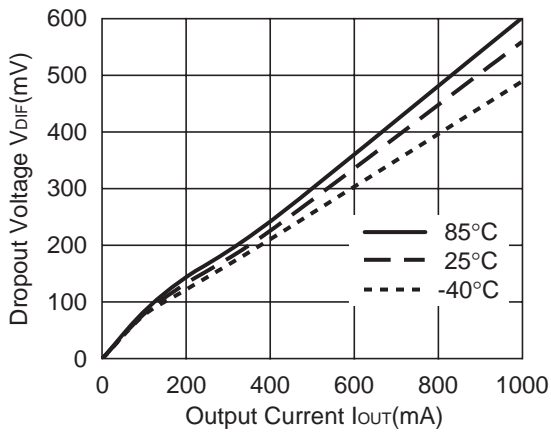

R1172x151x

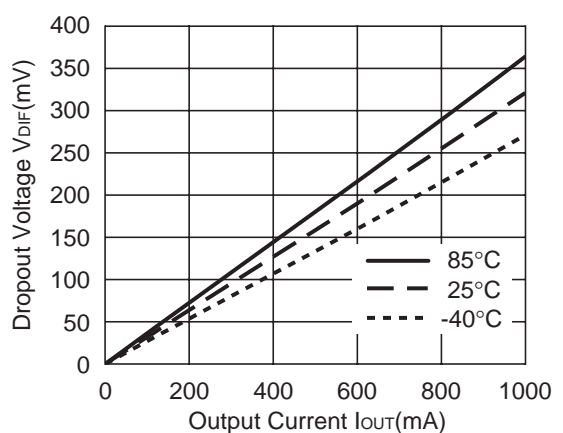

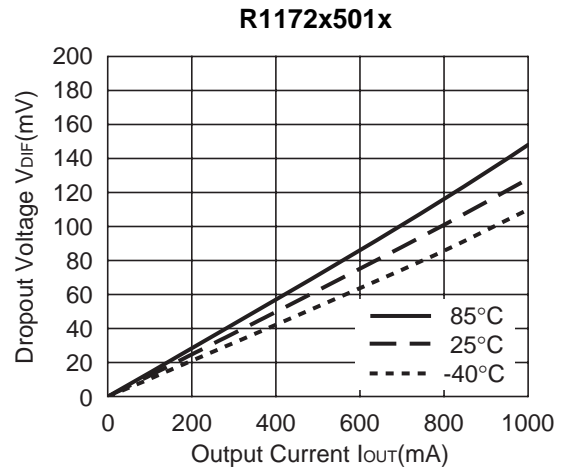
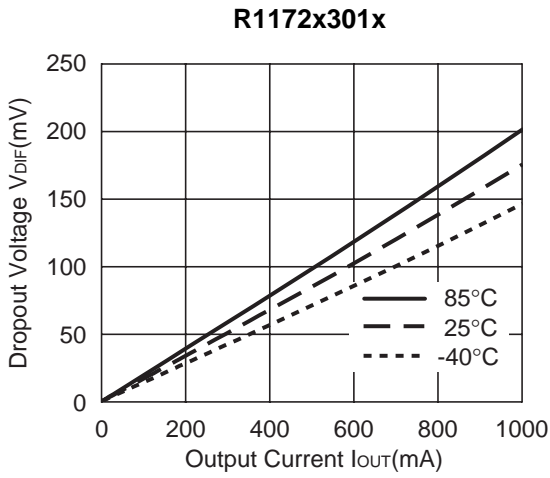

7) Dropout Voltage vs. Set Output Voltage

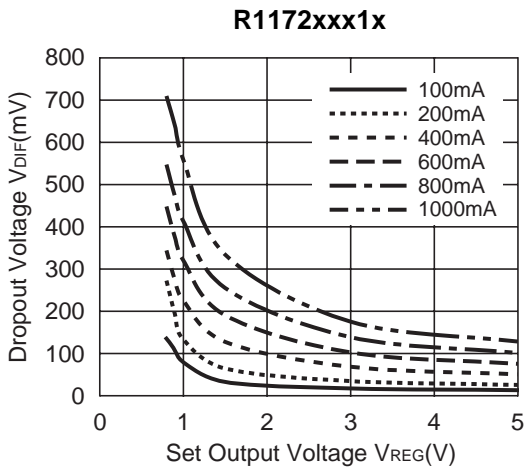

8) 0.8V Output type, Operating Input Voltage Range

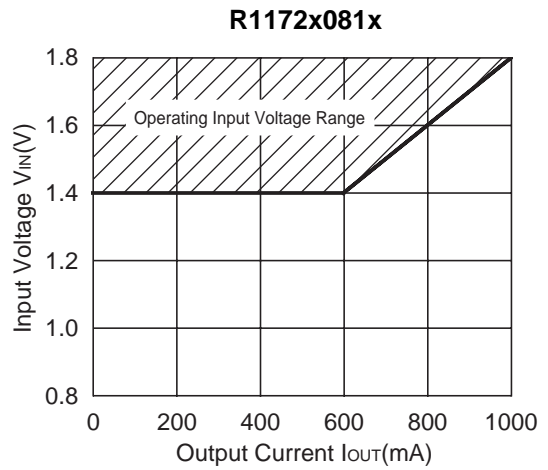

9) Ripple Rejection vs. Input Bias

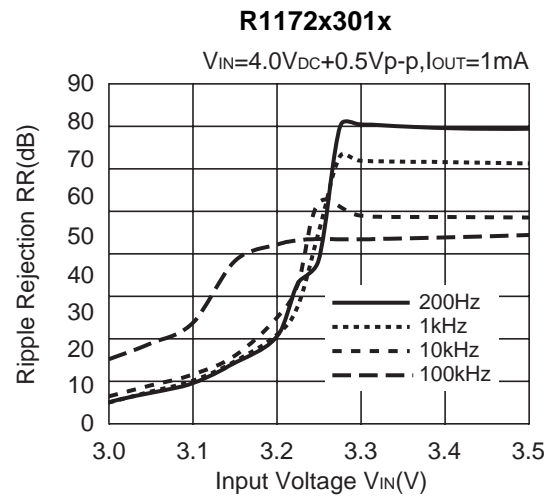
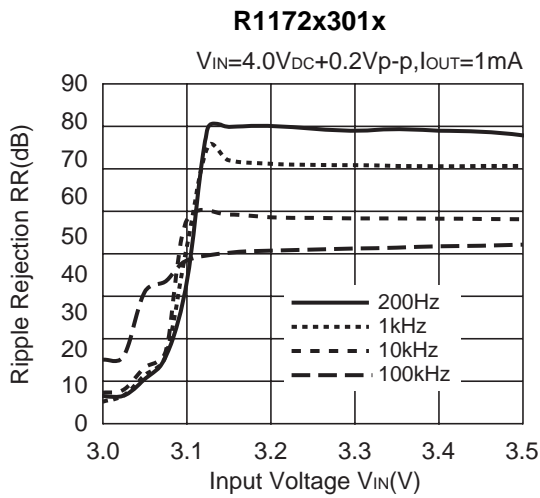

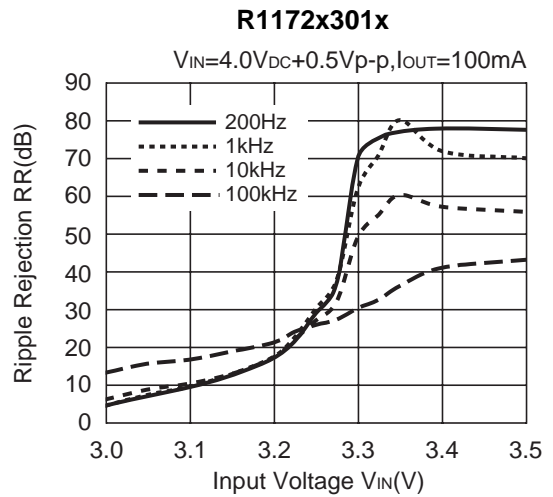
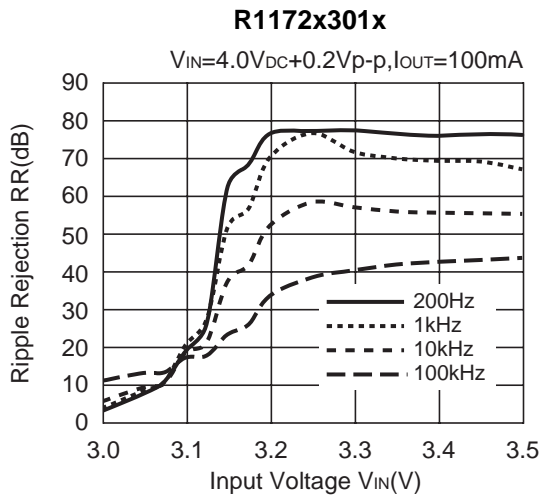
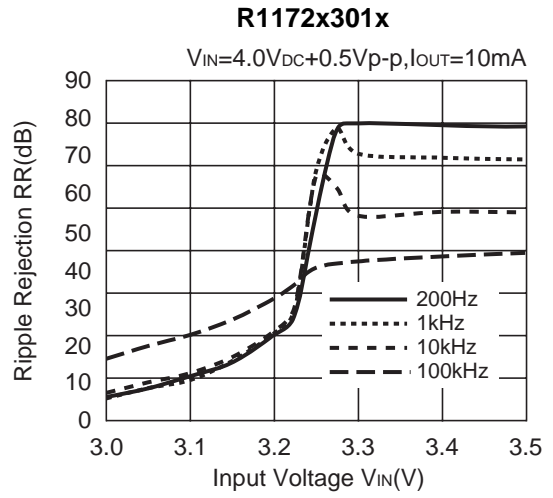
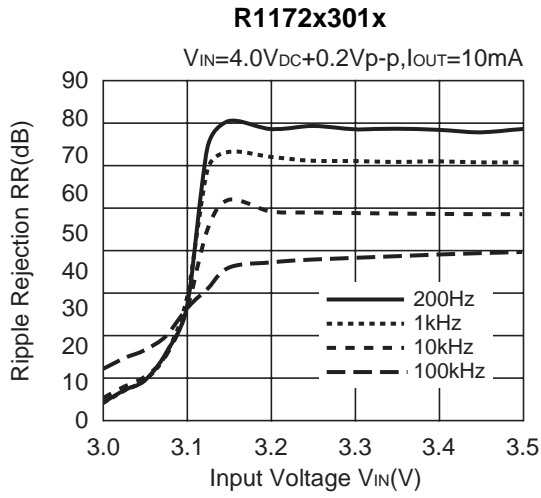

10) Ripple Rejection vs. Frequency

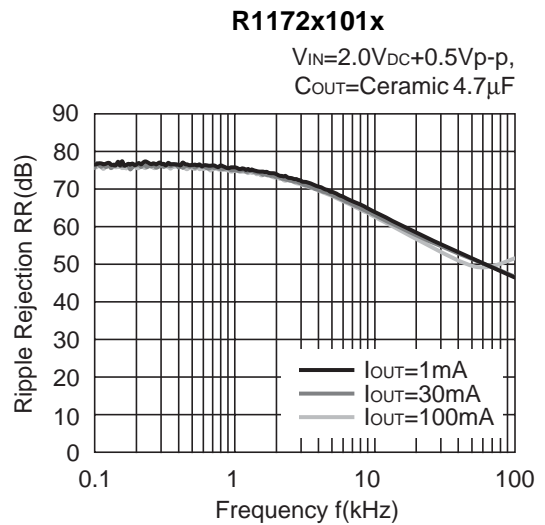
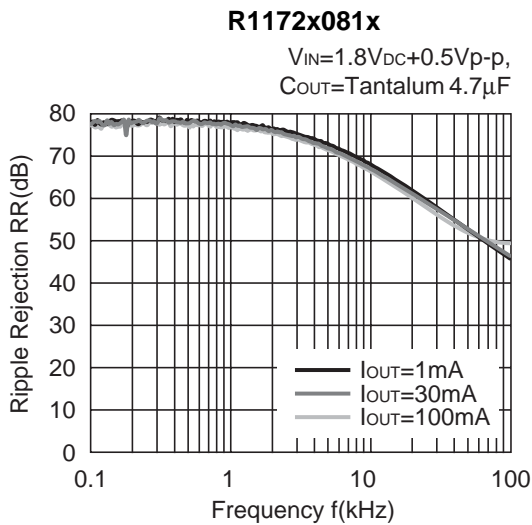

R1172x301x

$V_{IN}=4.0V_{DC}+0.5V_{p-p}$,
 $C_{OUT}=\text{Ceramic } 4.7\mu F$

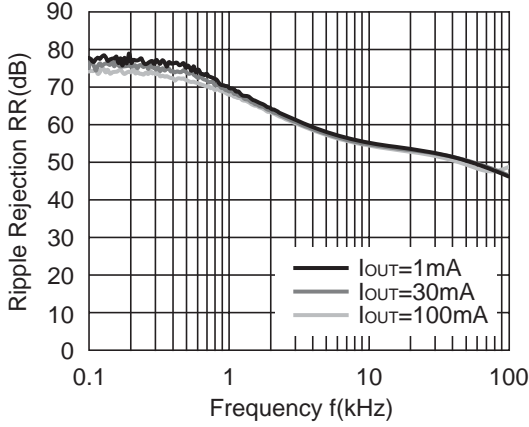

R1172x401x

$V_{IN}=5.0V_{DC}+0.5V_{p-p}$,
 $C_{OUT}=\text{Ceramic } 4.7\mu F$

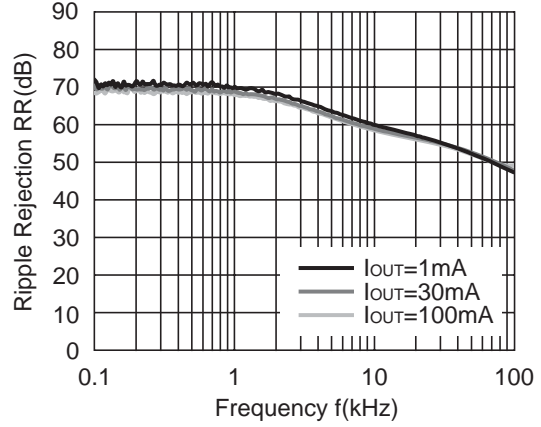

R1172x451x

$V_{IN}=5.5V_{DC}+0.5V_{p-p}$,
 $C_{OUT}=\text{Ceramic } 4.7\mu F$

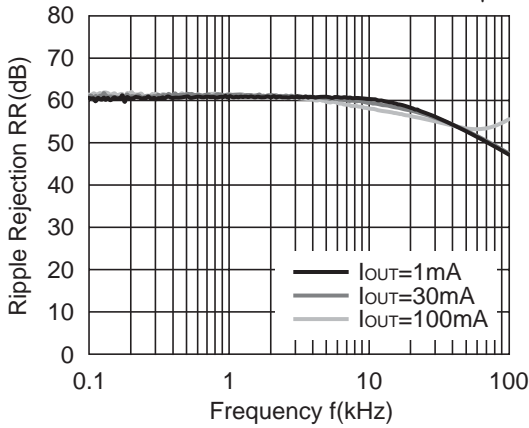

R1172x501x

$V_{IN}=6.0V_{DC}+0.5V_{p-p}$,
 $C_{OUT}=\text{Ceramic } 4.7\mu F$

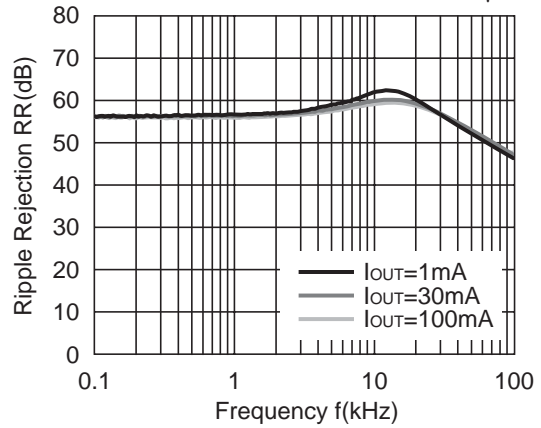

11) Line Transient Response ($t_r=t_f=5\mu s$, $I_{OUT}=100mA$)

R1172x081x

$C_{OUT}=\text{Tantalum } 4.7\mu F$

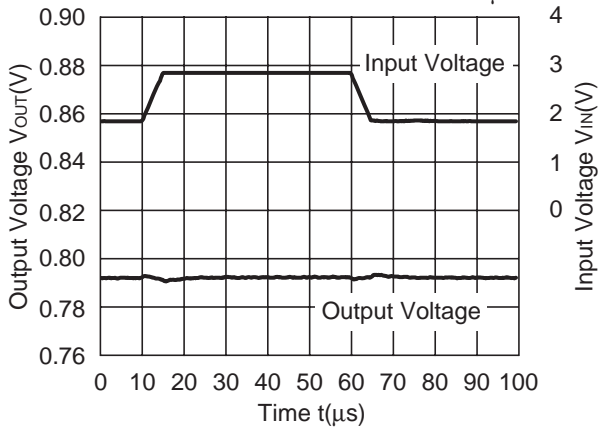

R1172x101x

$C_{OUT}=\text{Ceramic } 4.7\mu F$

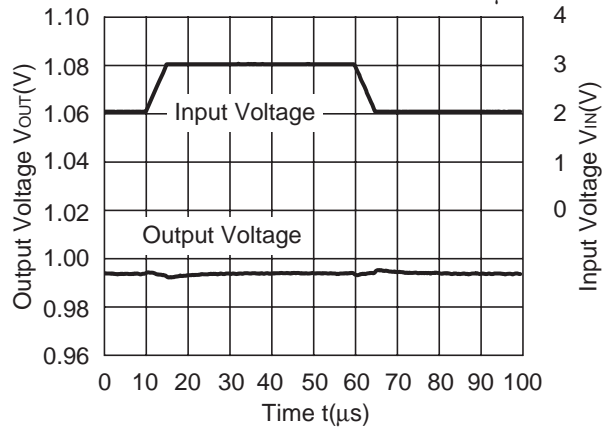

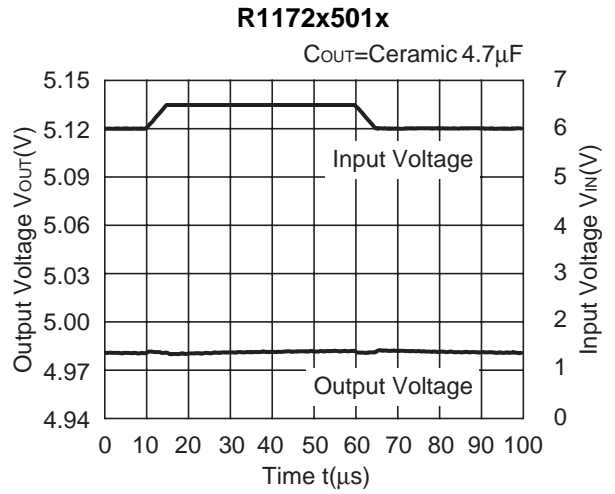
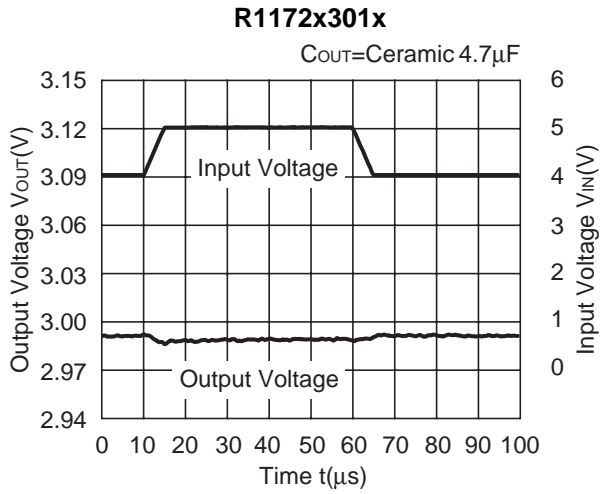

12) Load Transient Response ($t_r=t_f=500$ ns)

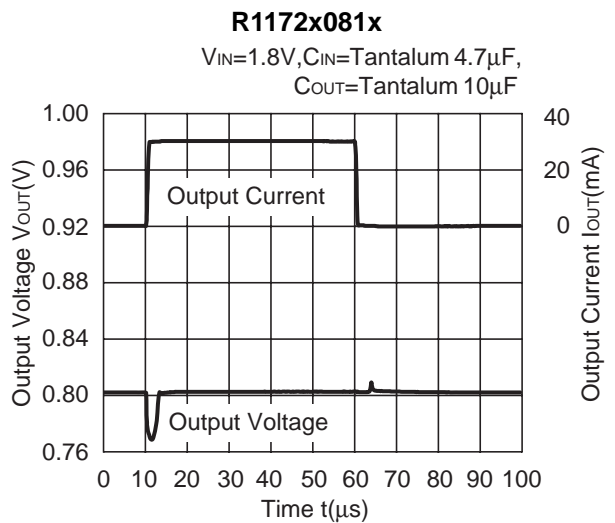
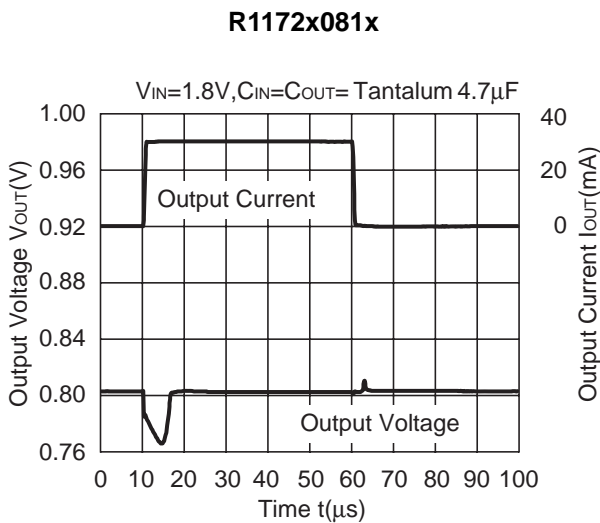
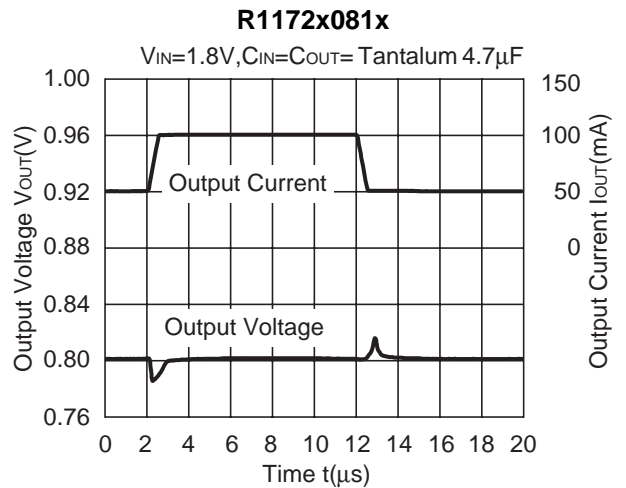
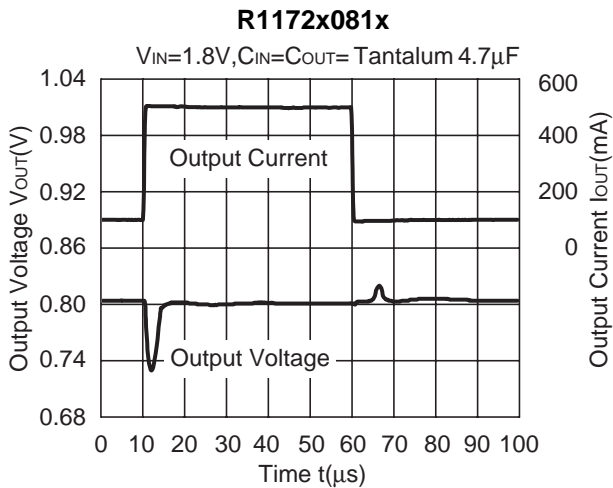

R1172x101x

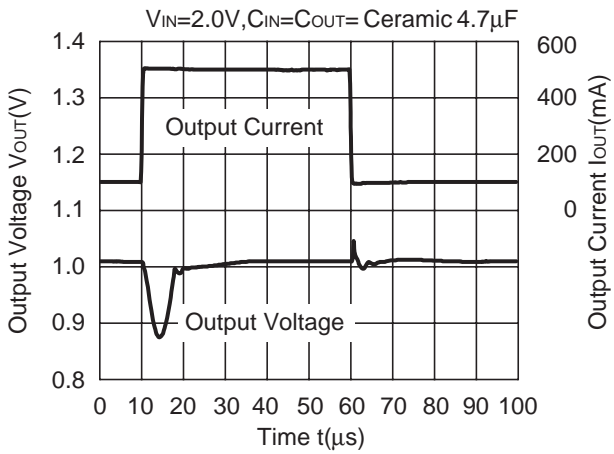

R1172x101x

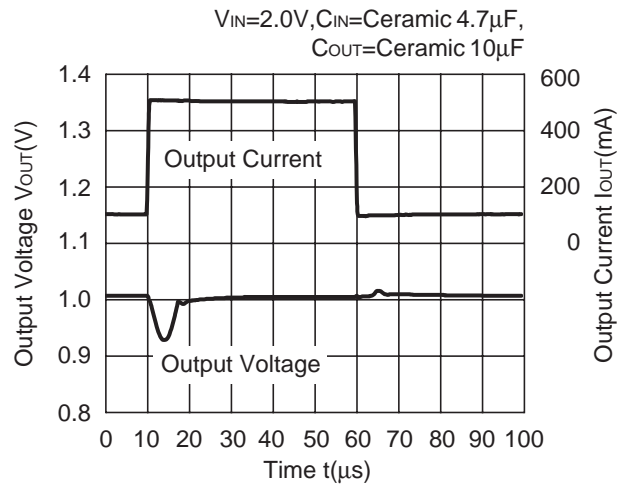

R1172x101x

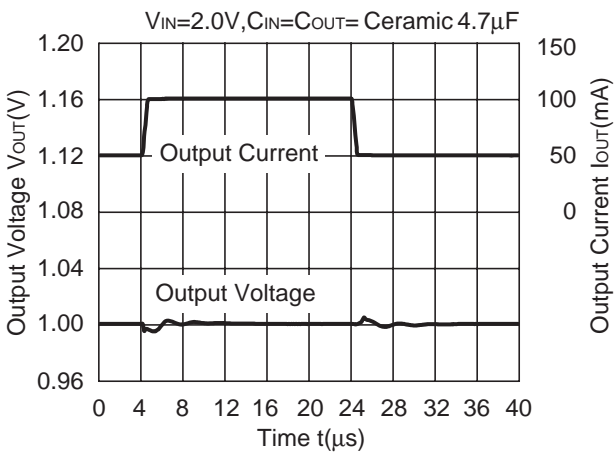

R1172x101x

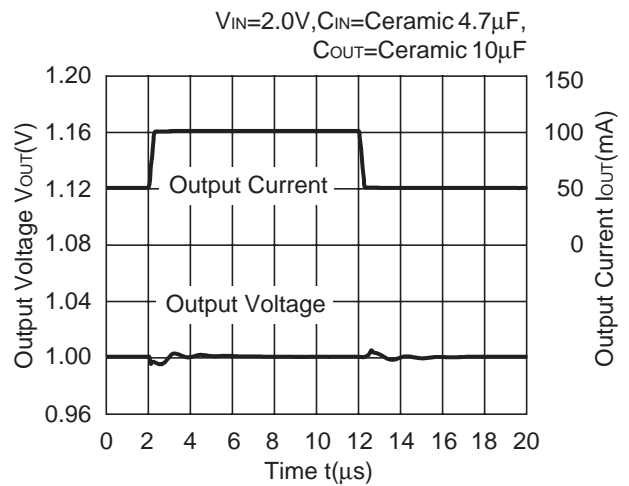

R1172x101x

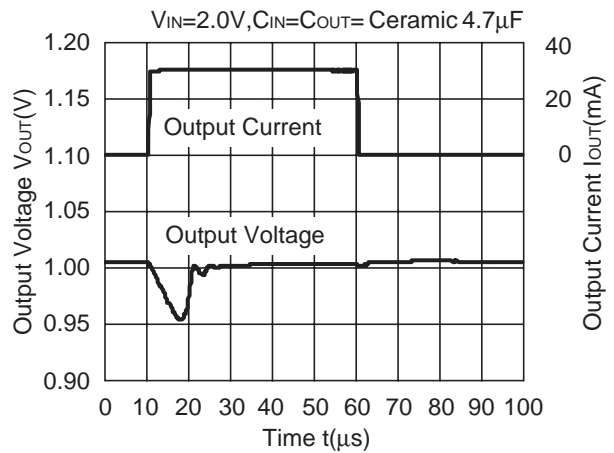

R1172x101x

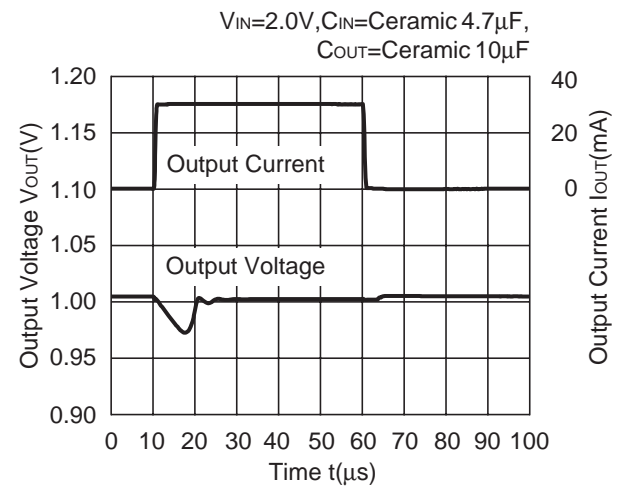

R1172x301x

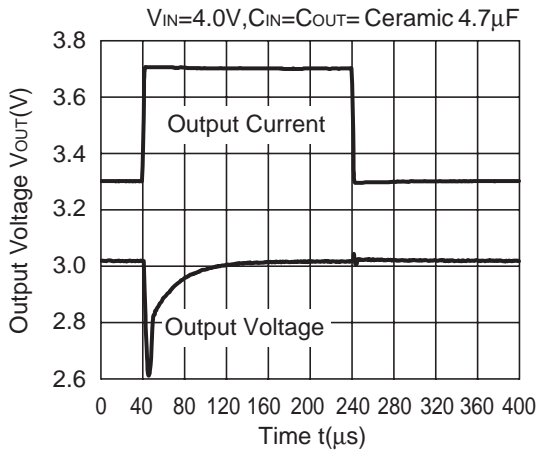

R1172x301x

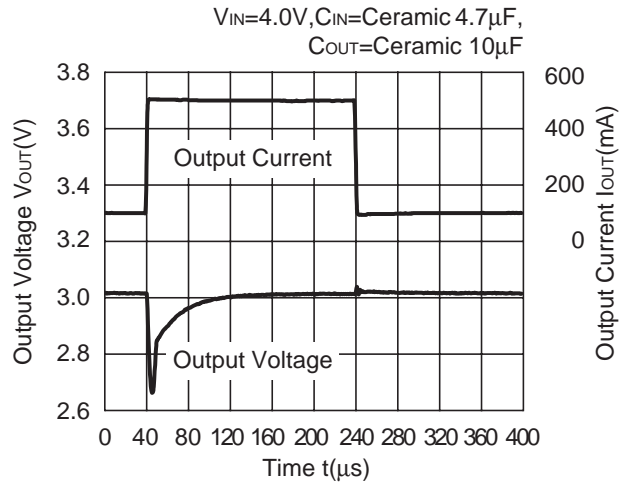

R1172x301x

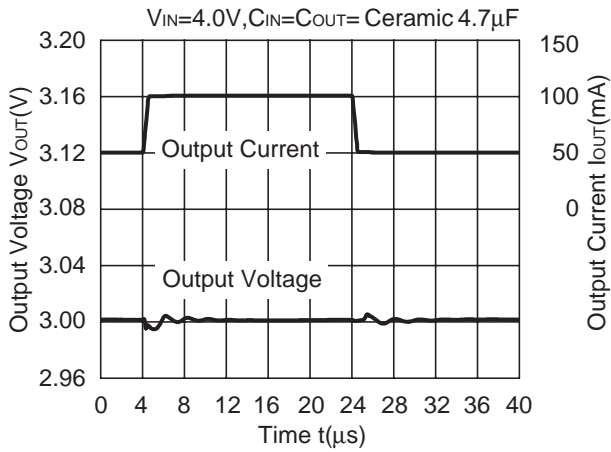

R1172x301x

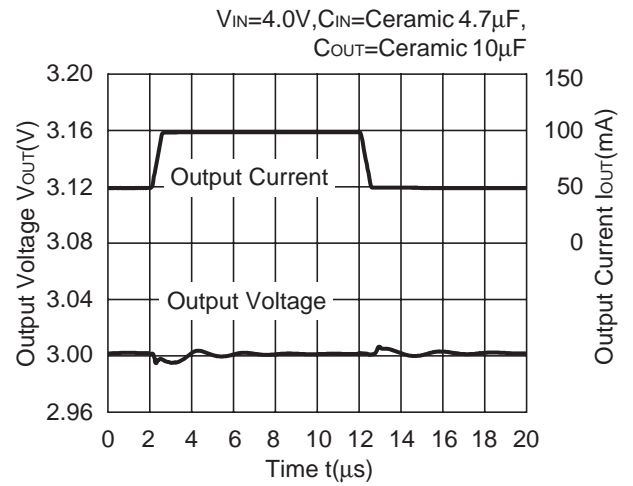

R1172x301x

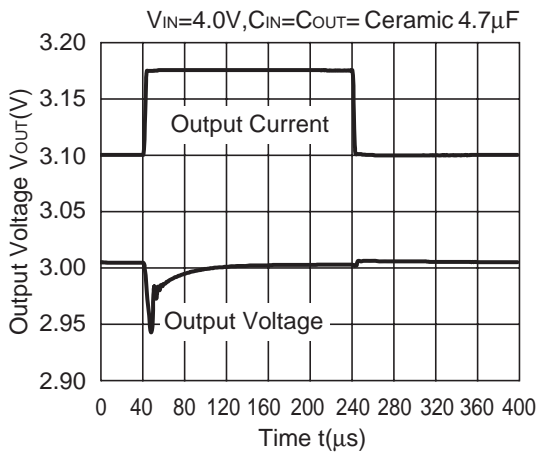

R1172x301x

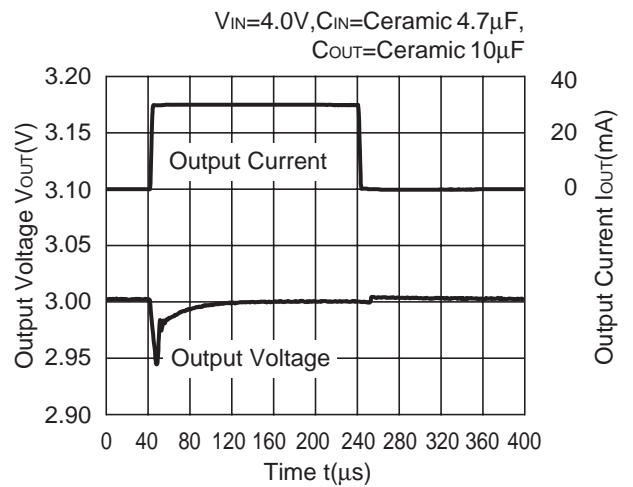

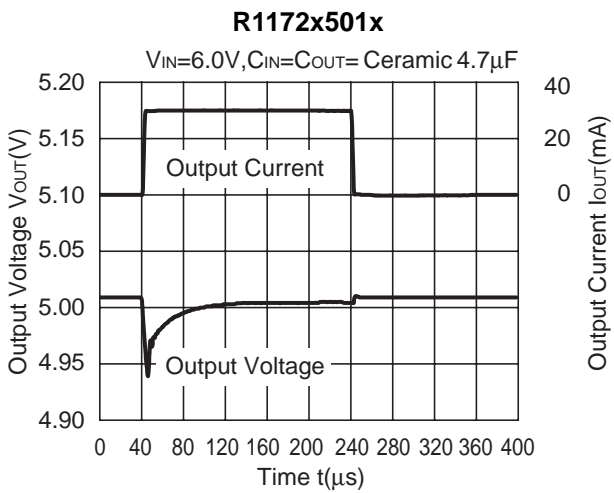
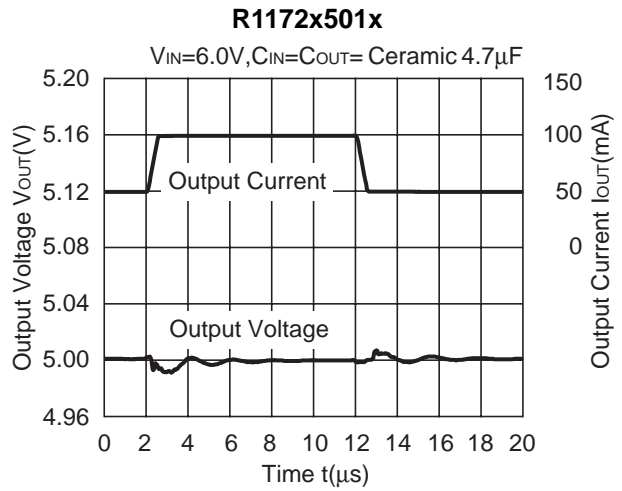
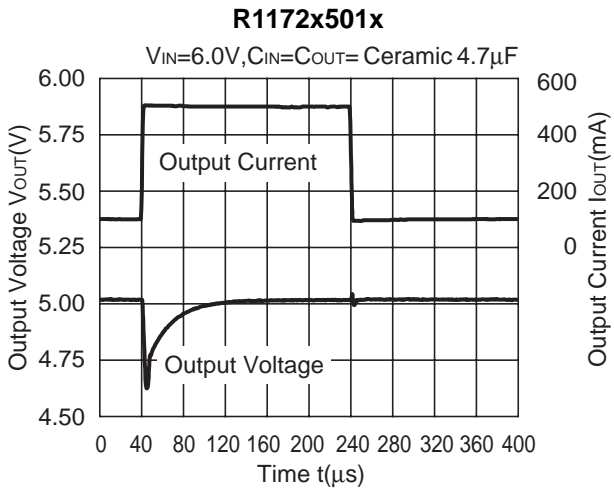

13) Turn-on speed with CE pin control

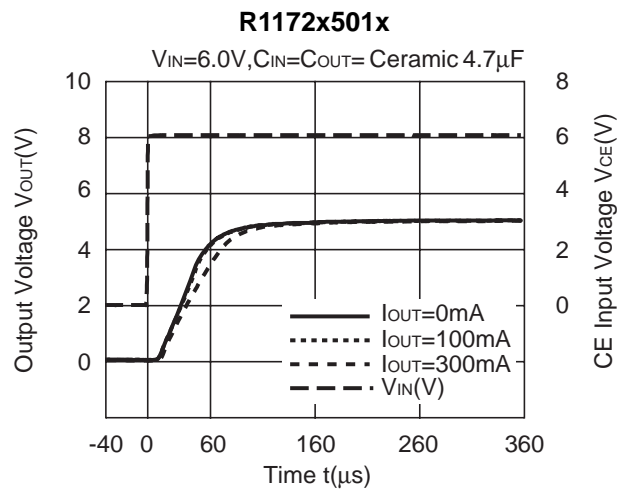
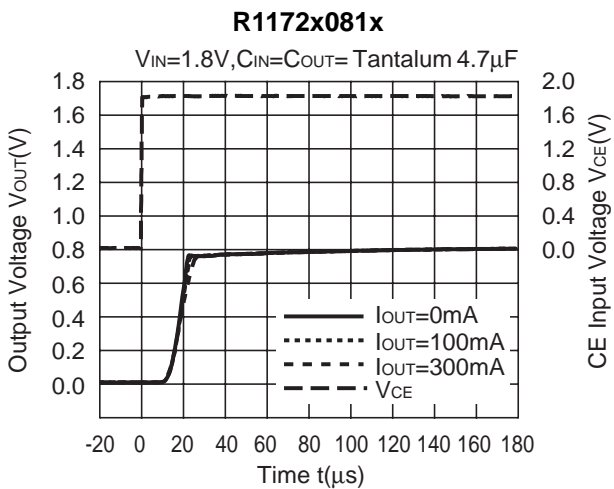

14) Turn-off speed with CE pin control

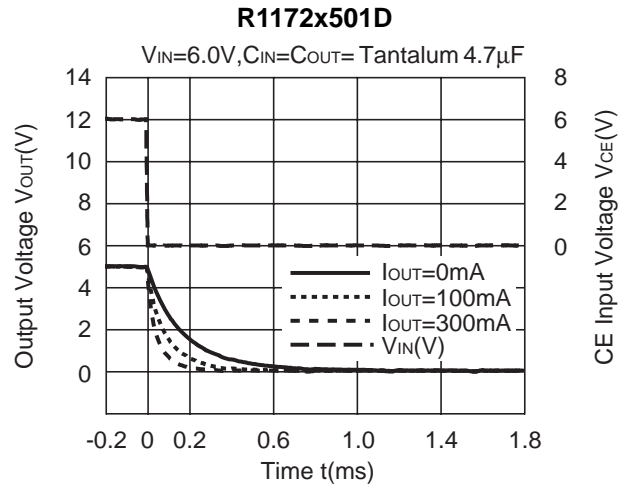
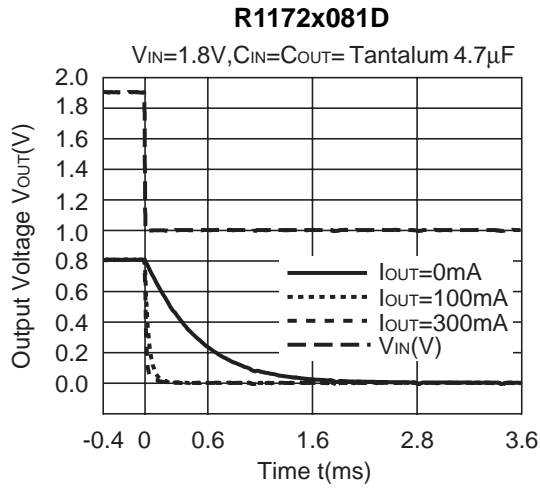

15) Inrush Current ($I_{out}=100mA, C_{in}=\text{none}$)

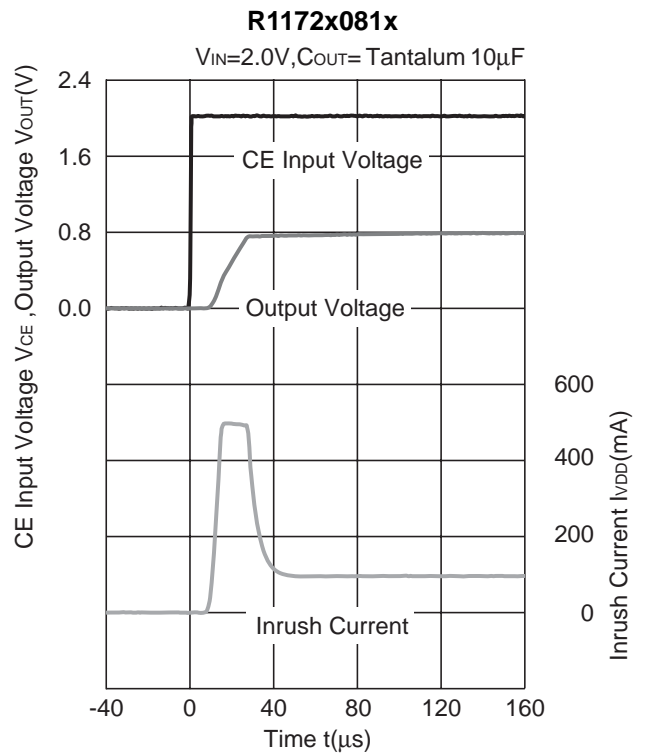
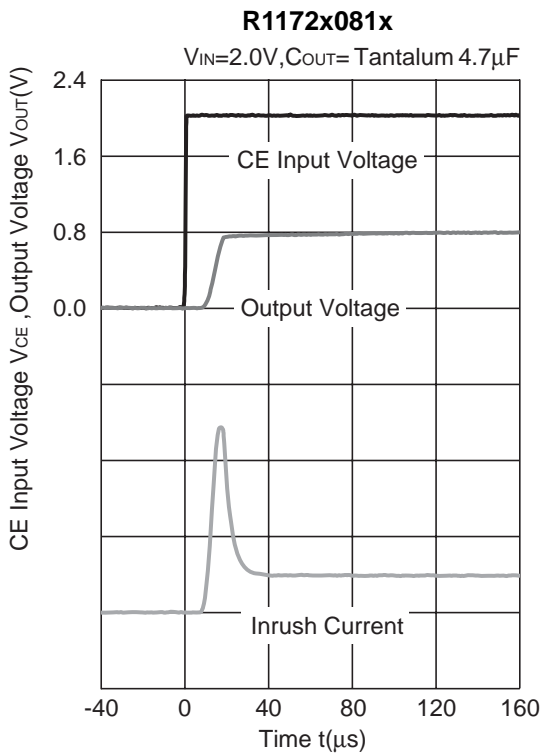

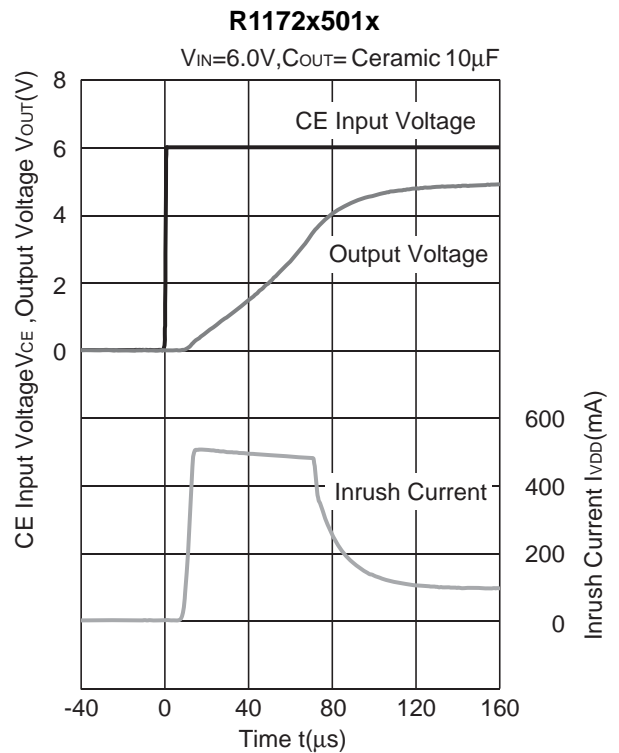
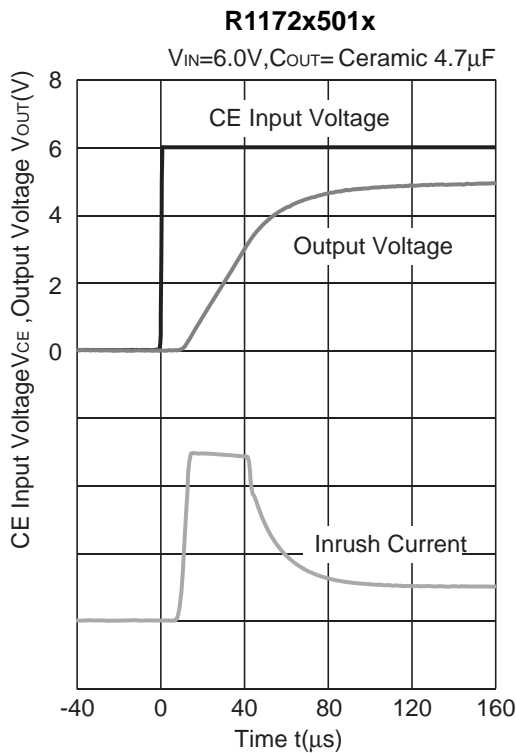
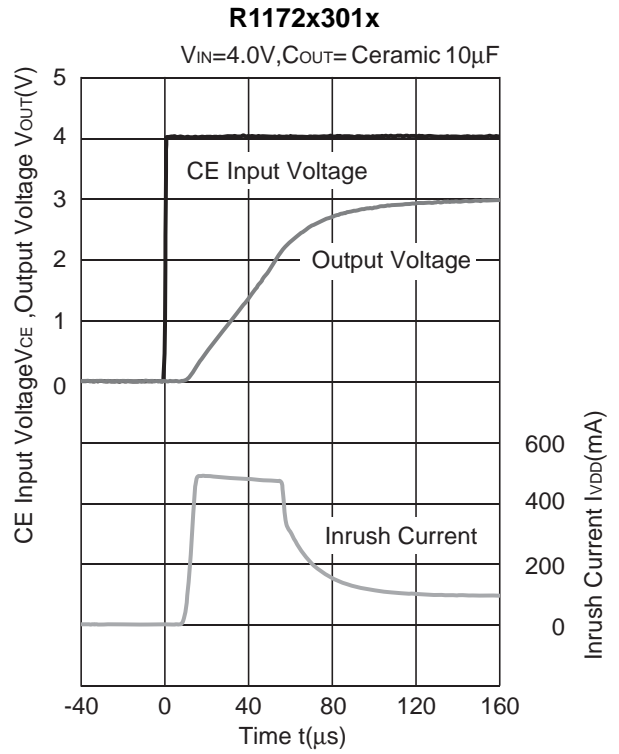
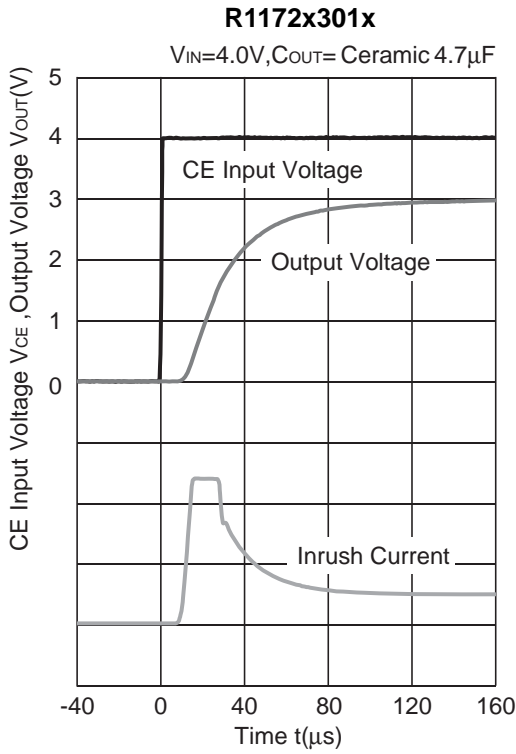

ESR vs. Output Current

When using these ICs, consider the following points:

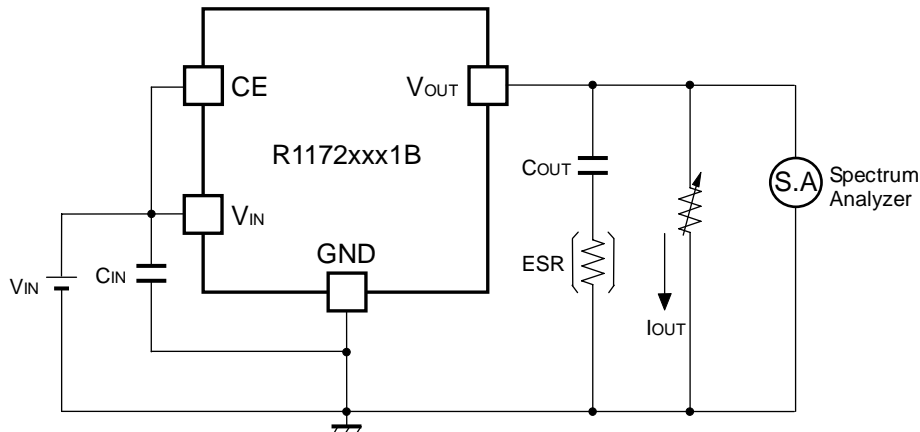

0.8V to 3.3V Output type: $C_{OUT}=4.7\mu\text{F}$ (Kyocera CM105X5R475M06AB)
 5.0V Output type : $C_{OUT}=4.7\mu\text{F}$ (Kyocera CT21X5R475K06AB)

As an output capacitor for this IC, Ceramic capacitor is recommendable. However, other low ESR type capacitor can be used with this IC.

For your reference, noise level is tested, and if the noise level is $40\mu\text{V}$ or less than $40\mu\text{V}$, the ESR values are plotted as stable area. Upper limit is described in the next five graphs, or ESR vs. Output Current. (Hatched area is the stable area.)

Measurement conditions

- $V_{IN}=V_{OUT}+1\text{V}$
- Frequency Band: 10Hz to 1MHz
- Temperature : 25°C

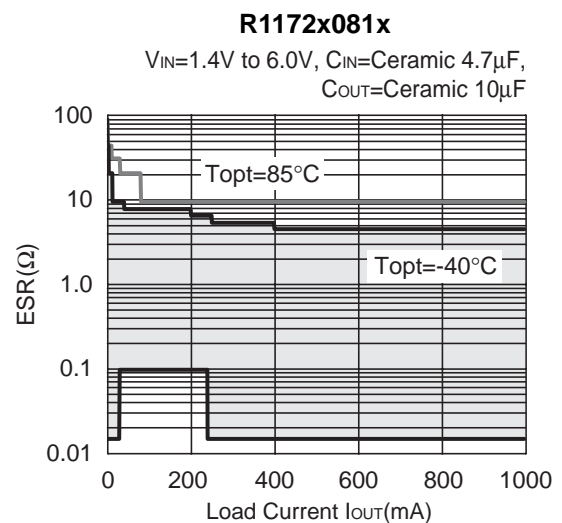
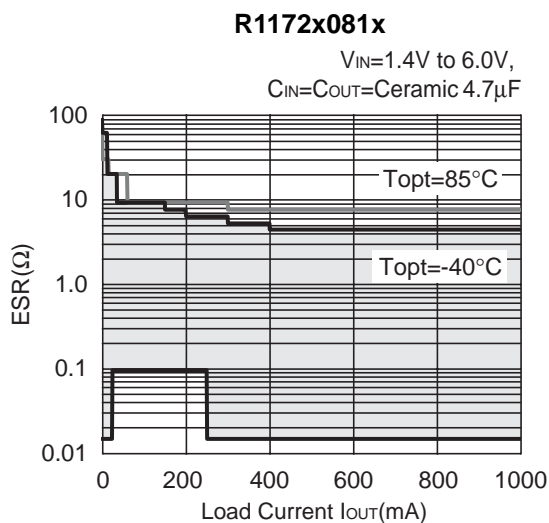

R1172x101x

$V_{IN}=1.4V$ to $6.0V$,
 $C_{IN}=C_{OUT}=\text{Ceramic } 4.7\mu F$

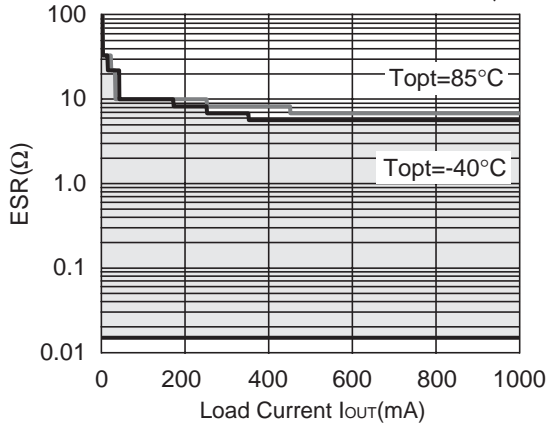

R1172x301x

$V_{IN}=3.1V$ to $6.0V$,
 $C_{IN}=C_{OUT}=\text{Ceramic } 4.7\mu F$

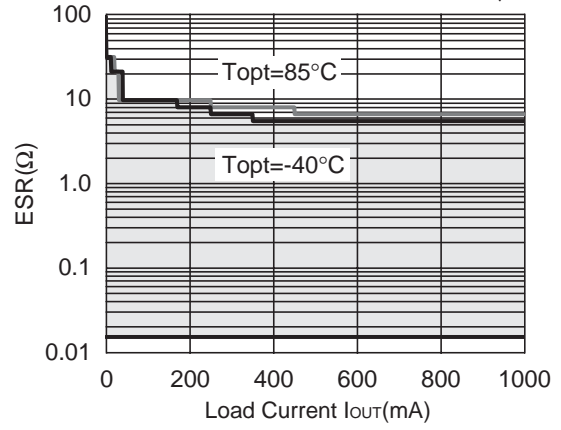

R1172x501x

$V_{IN}=5.3V$ to $6.0V$,
 $C_{IN}=C_{OUT}=\text{Ceramic } 4.7\mu F$

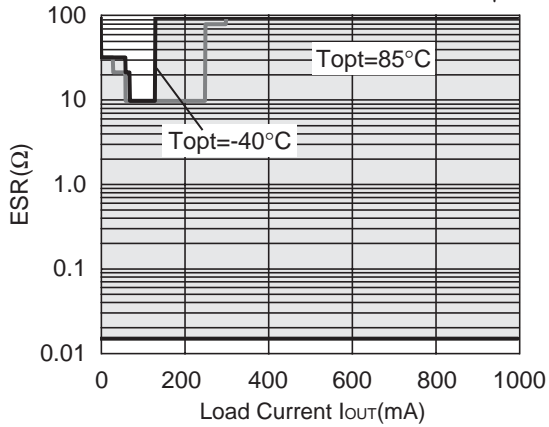



1. The products and the product specifications described in this document are subject to change or discontinuation of production without notice for reasons such as improvement. Therefore, before deciding to use the products, please refer to Ricoh sales representatives for the latest information thereon.
2. The materials in this document may not be copied or otherwise reproduced in whole or in part without prior written consent of Ricoh.
3. Please be sure to take any necessary formalities under relevant laws or regulations before exporting or otherwise taking out of your country the products or the technical information described herein.
4. The technical information described in this document shows typical characteristics of and example application circuits for the products. The release of such information is not to be construed as a warranty of or a grant of license under Ricoh's or any third party's intellectual property rights or any other rights.
5. The products listed in this document are intended and designed for use as general electronic components in standard applications (office equipment, telecommunication equipment, measuring instruments, consumer electronic products, amusement equipment etc.). Those customers intending to use a product in an application requiring extreme quality and reliability, for example, in a highly specific application where the failure or misoperation of the product could result in human injury or death (aircraft, spacevehicle, nuclear reactor control system, traffic control system, automotive and transportation equipment, combustion equipment, safety devices, life support system etc.) should first contact us.
6. We are making our continuous effort to improve the quality and reliability of our products, but semiconductor products are likely to fail with certain probability. In order to prevent any injury to persons or damages to property resulting from such failure, customers should be careful enough to incorporate safety measures in their design, such as redundancy feature, fire containment feature and fail-safe feature. We do not assume any liability or responsibility for any loss or damage arising from misuse or inappropriate use of the products.
7. Anti-radiation design is not implemented in the products described in this document.
8. The X-ray exposure can influence functions and characteristics of the products. Confirm the product functions and characteristics in the evaluation stage.
9. WLCSP products should be used in light shielded environments. The light exposure can influence functions and characteristics of the products under operation or storage.
10. There can be variation in the marking when different AOI (Automated Optical Inspection) equipment is used. In the case of recognizing the marking characteristic with AOI, please contact Ricoh sales or our distributor before attempting to use AOI.
11. Please contact Ricoh sales representatives should you have any questions or comments concerning the products or the technical information.



Ricoh is committed to reducing the environmental loading materials in electrical devices with a view to contributing to the protection of human health and the environment.

Ricoh has been providing RoHS compliant products since April 1, 2006 and Halogen-free products since April 1, 2012.

RICOH RICOH ELECTRONIC DEVICES CO., LTD.

<https://www.e-devices.ricoh.co.jp/en/>

Sales & Support Offices

Ricoh Electronic Devices Co., Ltd.

Shin-Yokohama Office (International Sales)

2-3, Shin-Yokohama 3-chome, Kohoku-ku, Yokohama-shi, Kanagawa, 222-8530, Japan
Phone: +81-50-3814-7687 Fax: +81-45-474-0074

Ricoh Americas Holdings, Inc.

675 Campbell Technology Parkway, Suite 200 Campbell, CA 95008, U.S.A.
Phone: +1-408-610-3105

Ricoh Europe (Netherlands) B.V.

Semiconductor Support Centre

Prof. W.H. Keesomlaan 1, 1183 DJ Amstelveen, The Netherlands
Phone: +31-20-5474-309

Ricoh International B.V. - German Branch

Semiconductor Sales and Support Centre

Oberrather Strasse 6, 40472 Düsseldorf, Germany
Phone: +49-211-6546-0

Ricoh Electronic Devices Korea Co., Ltd.

3F, Haesung Bldg, 504, Teheran-ro, Gangnam-gu, Seoul, 135-725, Korea
Phone: +82-2-2135-5700 Fax: +82-2-2051-5713

Ricoh Electronic Devices Shanghai Co., Ltd.

Room 403, No.2 Building, No.690 Bibo Road, Pu Dong New District, Shanghai 201203,
People's Republic of China
Phone: +86-21-5027-3200 Fax: +86-21-5027-3299

Ricoh Electronic Devices Shanghai Co., Ltd.

Shenzhen Branch

1205, Block D (Jinlong Building), Kingkey 100, Hongbao Road, Luohu District,
Shenzhen, China
Phone: +86-755-8348-7600 Ext 225

Ricoh Electronic Devices Co., Ltd.

Taipei office

Room 109, 10F-1, No.51, Hengyang Rd., Taipei City, Taiwan (R.O.C.)
Phone: +886-2-2313-1621/1622 Fax: +886-2-2313-1623

Mouser Electronics

Authorized Distributor

Click to View Pricing, Inventory, Delivery & Lifecycle Information:

Ricoh Electronics:

[R1172S181B-E2-FE](#) [R1172H151B-T1-FE](#) [R1172H501D-T1-FE](#) [R1172S121B-E2-FE](#) [R1172N331B-TR-FE](#)
[R1172N501D-TR-FE](#) [R1172S251D-E2-FE](#) [R1172N281D-TR-FE](#) [R1172H181D-T1-FE](#) [R1172S331D-E2-FE](#)
[R1172S121D-E2-FE](#) [R1172H501B-T1-FE](#) [R1172S301D-E2-FE](#) [R1172N251D-TR-FE](#) [R1172N181D-TR-FE](#)
[R1172H121B-T1-FE](#) [R1172H181B-T1-FE](#) [R1172N301D-TR-FE](#) [R1172N121D-TR-FE](#) [R1172H151D-T1-FE](#)
[R1172H361D-T1-FE](#) [R1172S141B-E2-FE](#) [R1172D301B-TR-FE](#) [R1172H101B-T1-FE](#) [R1172S151D-E2-FE](#)
[R1172H331D-T1-FE](#) [R1172D321D-TR-FE](#) [R1172N161D-TR-FE](#) [R1172S121D5-E2-FE](#) [R1172S251B-E2-FE](#)
[R1172H121A-T1-FE](#) [R1172N421D-TR-FE](#) [R1172D121D-TR-FE](#) [R1172N101D-TR-FE](#) [R1172S101B-E2-FE](#)
[R1172H201B-T1-FE](#) [R1172S181D-E2-FE](#) [R1172H301D-T1-FE](#) [R1172H251B-T1-FE](#) [R1172S131D-E2-FE](#)
[R1172D311D-TR-FE](#) [R1172H331B-T1-FE](#) [R1172N361D-TR-FE](#) [R1172S331B-E2-FE](#) [R1172S321D-E2-FE](#)
[R1172D331D-TR-FE](#) [R1172N311D-TR-FE](#) [R1172H251D-T1-FE](#) [R1172H121D-T1-FE](#) [R1172N151D-TR-FE](#)
[R1172N331D-TR-FE](#) [R1172D081D-TR-FE](#) [R1172D121A-TR-FE](#) [R1172D121B-TR-FE](#) [R1172D131D-TR-FE](#)
[R1172D151D-TR-FE](#) [R1172D181A-TR-FE](#) [R1172S371B-E2-FE](#) [R1172S501B-E2-FE](#) [R1172S131B-E2-FE](#)
[R1172S151B-E2-FE](#) [R1172S161D-E2-FE](#) [R1172S261B-E2-FE](#) [R1172S281D-E2-FE](#) [R1172S331A-E2-FE](#)
[R1172N411D-TR-FE](#) [R1172N451D-TR-FE](#) [R1172N471D-TR-FE](#) [R1172N501A-TR-FE](#) [R1172N501B-TR-FE](#)
[R1172S121A-E2-FE](#) [R1172N311B-TR-FE](#) [R1172N321B-TR-FE](#) [R1172N321D-TR-FE](#) [R1172N331A-TR-FE](#)
[R1172N401B-TR-FE](#) [R1172N401D-TR-FE](#) [R1172N191D-TR-FE](#) [R1172N221D-TR-FE](#) [R1172N271D-TR-FE](#)
[R1172N291D-TR-FE](#) [R1172N301B-TR-FE](#) [R1172N311A-TR-FE](#) [R1172N101B-TR-FE](#) [R1172N111D-TR-FE](#)
[R1172N121B-TR-FE](#) [R1172N131D-TR-FE](#) [R1172N141B-TR-FE](#) [R1172N171B-TR-FE](#) [R1172H201D-T1-FE](#)
[R1172H361B-T1-FE](#) [R1172H371D-T1-FE](#) [R1172H381D-T1-FE](#) [R1172H451D-T1-FE](#) [R1172N081D-TR-FE](#)
[R1172D501B-TR-FE](#) [R1172D501D-TR-FE](#) [R1172H101D-T1-FE](#) [R1172H121D5-T1-FE](#) [R1172H131D-T1-FE](#)