



GaAs MMIC SP4T NON-REFLECTIVE POSITIVE CONTROL SWITCH, DC* - 8 GHz

Typical Applications

This switch is suitable for usage in DC - 8.0 GHz 50-Ohm or 75-Ohm systems:

- Broadband
- Fiber Optics
- Switched Filter Banks
- Wireless below 8 GHz

Features

- Broadband Performance: DC - 8 GHz
- High Isolation: 35 dB@ 6 GHz
- Low Insertion Loss: 2.0 dB@ 6 GHz
- Integrated Positive Supply 2:4 TTL Decoder
- 16 Lead 3x3mm QFN Package: 9 mm²

Functional Diagram

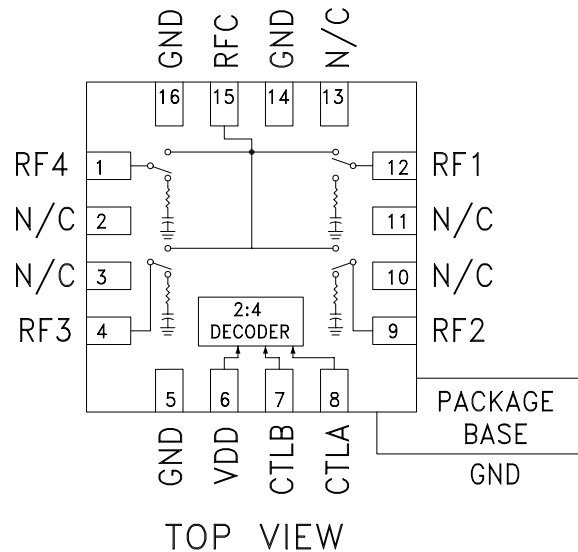

General Description

The HMC345ALP3E is a broadband non-reflective GaAs MESFET SP4T switch in a low cost leadless surface mount packages. Covering DC to 8 GHz, this switch offers high isolation and low insertion loss. This switch also includes an on board binary decoder circuit which reduces the required logic control lines to two. The switch operates using a positive control voltage of 0/+5V, and requires a fixed bias of +5V.

* Blocking capacitors are required at ports RFC and RF1, 2, 3, & 4. Their value will determine the lowest transmission frequency.

Electrical Specifications, $T_A = +25^\circ \text{C}$, With 0/+5V Control, 50 Ohm System

Parameter	Frequency	Min.	Typ.	Max.	Units
Insertion Loss	DC - 2.0 GHz		1.7	2.4	dB
	DC - 6.0 GHz		2.0	2.6	dB
	DC - 8.0 GHz		2.4	2.9	dB
Isolation	DC - 2.0 GHz	37	42		dB
	DC - 4.0 GHz	32	37		dB
	DC - 6.0 GHz	31	35		dB
	DC - 8.0 GHz	27	33		dB
Return Loss	"On State"	DC - 2.0 GHz		16	dB
		DC - 4.0 GHz		16	dB
		DC - 6.0 GHz		16	dB
		DC - 8.0 GHz		13	dB
Return Loss (RF1 - RF4)	"Off State"	2.0 - 8.0 GHz		14	dB
Input Power for 1 dB Compression	2.0 - 8.0 GHz	23	28		dBm
Input Third Order Intercept (Two-Tone Input Power = +10 dBm Each Tone, 1MHz Tone Separation)	2.0 - 8.0 GHz	37	43		dBm
Switching Characteristics tRISE, tFALL (10/90% RF) tON, tOFF (50% CTL to 10/90% RF)	DC - 8.0 GHz		40		ns
			100		ns

Information furnished by Analog Devices is believed to be accurate and reliable. However, no responsibility is assumed by Analog Devices for its use, nor for any infringements of patents or other rights of third parties that may result from its use. Specifications subject to change without notice. No license is granted by implication or otherwise under any patent or patent rights of Analog Devices. Trademarks and registered trademarks are the property of their respective owners.

For price, delivery, and to place orders: Analog Devices, Inc., One Technology Way, P.O. Box 9106, Norwood, MA 02062-9106
Phone: 781-329-4700 • Order online at www.analog.com
Application Support: Phone: 1-800-ANALOG-D



GaAs MMIC SP4T NON-REFLECTIVE POSITIVE CONTROL SWITCH, DC* - 8 GHz

Insertion Loss vs. Temperature

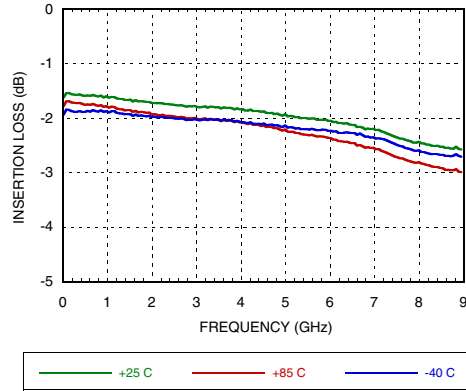

Isolation

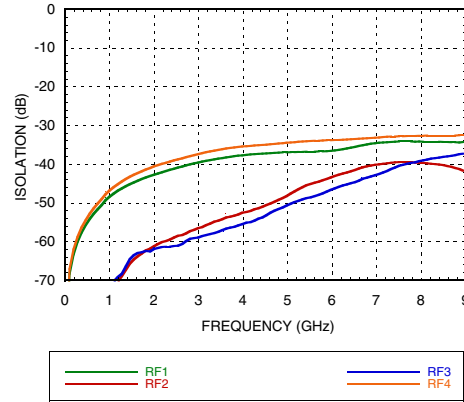

Return Loss

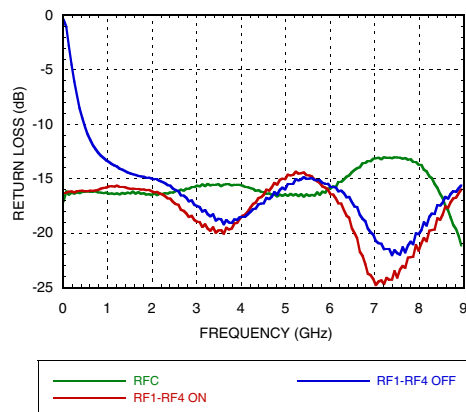

0.1 and 1 dB Input Compression Point

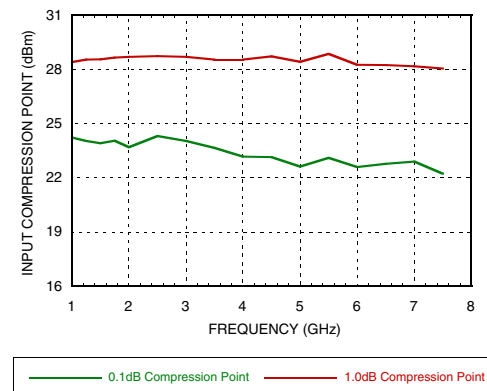

Input Third Order Intercept Point

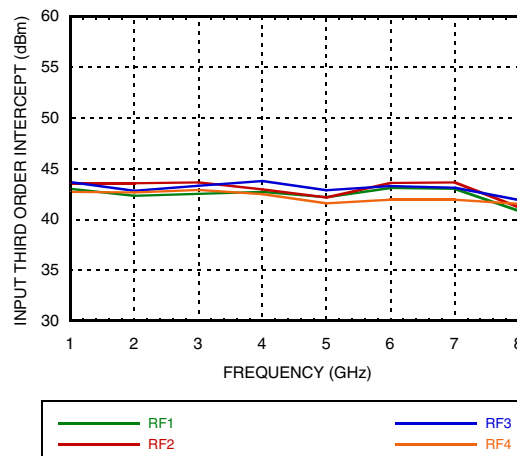



GaAs MMIC SP4T NON-REFLECTIVE POSITIVE CONTROL SWITCH, DC* - 8 GHz

Absolute Maximum Ratings

Bias Voltage Range (Vdd)	+7.0 Vdc
Control Voltage Range (A & B)	-0.5V to Vdd +1.0 Vdc
Channel Temperature	150 °C
Thermal Resistance (Insertion Loss Path)	154 °C/W
Thermal Resistance (Terminated Path)	228 °C/W
Storage Temperature	-65 to +150 °C
Operating Temperature	-40 to +85 °C
Maximum Input Power	+24 dBm
ESD Sensitivity (HBM)	Class 1A

Bias Voltage & Current

Vdd Range = +5 Vdc ± 10%		
Vdd (Vdc)	Idd (Typ.) (mA)	Idd (Max.) (mA)
+5	2.5	6.0

Control Voltages

State	Bias Condition
Low	0 to +0.8 Vdc @ 1 µA Typical
High	+2.0 to +5 Vdc @ 50 µA Typical

Truth Table

Control Input		Signal Path State
A	B	RFCOM to:
Low	Low	RF1
High	Low	RF2
Low	High	RF3
High	High	RF4

Note: DC blocking capacitors are required at ports RFC and RF1, 2, 3, & 4. Their value will determine the lowest transmission frequency.



**ELECTROSTATIC SENSITIVE DEVICE
OBSERVE HANDLING PRECAUTIONS**



GaAs MMIC SP4T NON-REFLECTIVE POSITIVE CONTROL SWITCH, DC* - 8 GHz

Outline Drawing

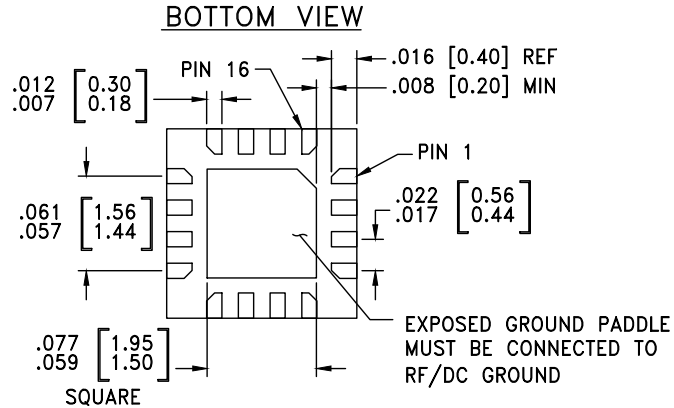
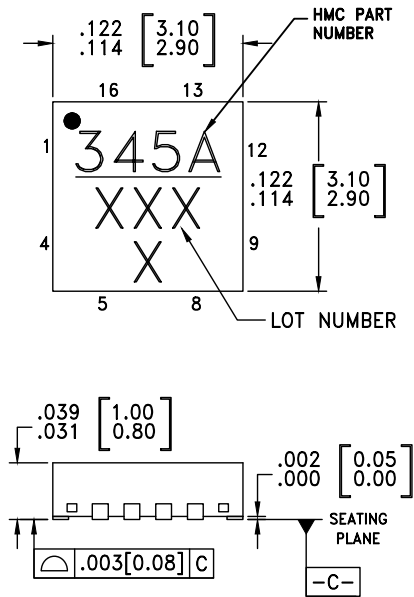

NOTES:

1. LEADFRAME MATERIAL: COPPER ALLOY
2. DIMENSIONS ARE IN INCHES [MILLIMETERS]
3. LEAD SPACING TOLERANCE IS NON-CUMULATIVE.
4. PAD BURR LENGTH SHALL BE 0.15mm MAXIMUM. PAD BURR HEIGHT SHALL BE 0.05mm MAXIMUM.
5. PACKAGE WARP SHALL NOT EXCEED 0.05mm.
6. ALL GROUND LEADS AND GROUND PADDLE MUST BE SOLDERED TO PCB RF GROUND.
7. REFER TO HITTITE APPLICATION NOTE FOR SUGGESTED LAND PATTERN.

Package Information

Part Number	Package Body Material	Lead Finish	MSL Rating	Package Marking ^[2]
HMC345ALP3E	RoHS-compliant Low Stress Injection Molded Plastic	100% matte Sn	MSL3 ^[1]	345A XXXX

[1] Max peak reflow temperature of 260 °C

[2] 4-Digit lot number XXXX



GaAs MMIC SP4T NON-REFLECTIVE POSITIVE CONTROL SWITCH, DC* - 8 GHz

Pin Descriptions

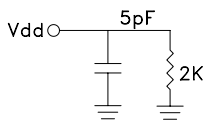
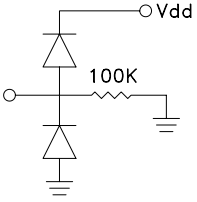
Pin Number	Function	Description	Interface Schematic
1, 4, 9, 12, 15	RF4, RF3, RF2, RF1, RFC	This pin is DC coupled and matched to 50 Ohm. Blocking capacitors are required.	
2, 3, 10, 11, 13	N/C	This pin should be connected to PCB RF ground to maximize isolation.	
5, 14, 16	GND	Package bottom has exposed metal paddle that must also be connected to PCB RF ground.	
6	VDD	Supply Voltage +5V ± 10%	
7	CTLB	See truth table and control voltage table.	
8	CTLA	See truth table and control voltage table.	



GaAs MMIC SP4T NON-REFLECTIVE POSITIVE CONTROL SWITCH, DC* - 8 GHz

Evaluation PCB

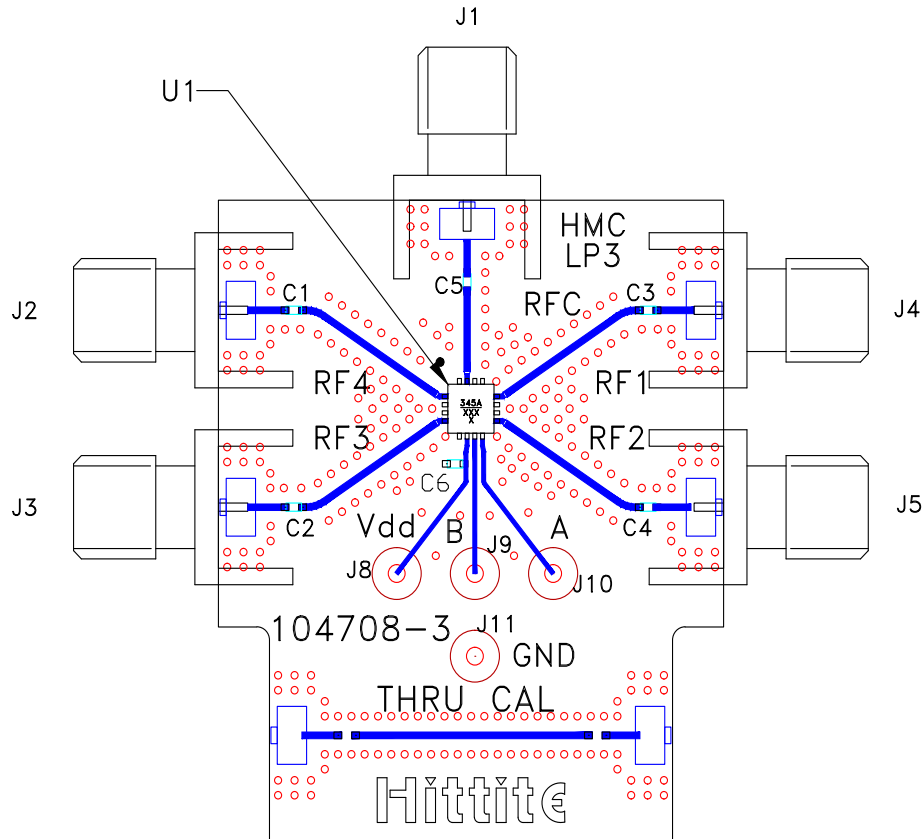

List of Materials for Evaluation PCB EV1HMC345ALP3^[1]

Item	Description
J1 - J5	PCB Mount SMA RF Connector
J8 - J11	DC Pin
C1 - C5	100 pF Capacitor, 0402 Pkg.
C6	1k pF Capacitor, 0402 Pkg.
U1	HMC345ALP3E SP4T Switch
PCB [2]	104708 Evaluation PCB 1.29"x1.55"

[1] Reference this number when ordering complete evaluation PCB

[2] Circuit Board Material: Rogers 4350

The circuit board used in the final application should be generated with proper RF circuit design techniques. Signal lines at the RF port should have 50 ohm impedance and the package ground leads and backside ground slug should be connected directly to the ground plane similar to that shown above. The evaluation circuit board shown above is available from Analog Devices, upon request.

Mouser Electronics

Authorized Distributor

Click to View Pricing, Inventory, Delivery & Lifecycle Information:

[Analog Devices Inc.:](#)

[HMC345ALP3E](#) [HMC345ALP3ETR](#) [EV1HMC345ALP3](#)