

CLMVC-FKA: PLCC4 3 in 1 SMD LED



PRODUCT DESCRIPTION

The CLMVC-FKA full-color RGB LED offers a high-intensity light output and a wide viewing angle. The compact 2mm x 2mm package allows for a very high resolution screen and is designed to work in a wide array of environmental conditions. Cree LED PLCC full-color RGB LEDs are suited for indoor video screen, decorative lighting and amusement applications.

FEATURES

- Size (mm): 2.0 x 2.0
- Dominant Wavelength
Red (619 - 624nm)
Green (520 - 535nm)
Blue (460 - 475nm)
- Luminous Intensity (mcd)
Red (56 - 112)@ 5mA
Green (140 - 355)@ 5mA
Blue (28 - 71)@ 5mA
- Lead-Free
- RoHS Compliant
- Matte Surface

APPLICATIONS

- Full-Color Video Screen
- Decorative Lighting
- Amusement

ABSOLUTE MAXIMUM RATINGS ($T_A = 25^\circ\text{C}$)

Items	Symbol	Absolute Maximum Rating			Unit
		R	G	B	
Forward Current ^{Note 1}	I_F	25	13	13	mA
Peak Forward Current ^{Note 2}	I_{FP}	70	50	50	mA
Reverse Voltage	V_R	5	5	5	V
Power Dissipation	P_D	60	49	49	mW
Operation Temperature	T_{opr}	-40 ~ +100			$^\circ\text{C}$
Storage Temperature	T_{stg}	-40 ~ +100			$^\circ\text{C}$
Junction Temperature	T_J	110	110	110	$^\circ\text{C}$
Junction/ambient 1 chip on	R_{THJA}	350	490	430	$^\circ\text{C/W}$
Junction/solder point 1 chip on	R_{THJS}	240	480	380	$^\circ\text{C/W}$

Note:

1. Single-color light
2. Pulse width ≤ 0.1 msec, duty $\leq 1/10$.

TYPICAL ELECTRICAL & OPTICAL CHARACTERISTICS ($T_A = 25^\circ\text{C}$)

Characteristics	Condition	Symbol	Values			Unit
			R	G	B	
Dominant Wavelength	$I_F = 5\text{mA}$	λ_{DOM}	619~624	520~535	460~475	nm
Spectral bandwidth at 50% I_{REL} max	$I_F = 5\text{mA}$	$\Delta \lambda$	24	38	28	nm
Forward Voltage	$I_F = 5\text{mA}$	$V_{F(avg)}$	1.9	2.9	3.0	V
		$V_{F(max)}$	2.4	3.7	3.7	V
Luminous Intensity	$I_F = 5\text{mA}$	$I_{V(min)}$	56	140	28	mcd
		$I_{V(avg)}$	80	225	43	mcd
Luminous Intensity(Reference)	$I_F = 20/10/10\text{mA}$	$\Phi_{V(avg)}$	310	340	69	mcd
Reverse Current (max)	$V_R = 5\text{V}$	I_R	10	10	10	μA

- * Continuous reverse voltage can cause LED damage.

INTENSITY BIN LIMIT

Red (5 mA)			Green (5 mA)			Blue (5 mA)		
Bin Code	Min.(mcd)	Max.(mcd)	Bin Code	Min.(mcd)	Max.(mcd)	Bin Code	Min.(mcd)	Max.(mcd)
L	56	71	D	140	180	L7	28	36
3c3b	64	81	9a	160	202	3j3h	32	41
A	71	90	E	180	224	L8	36	45
3a4	81	101	bc	202	252	3g3f	41	51
B	90	112	F	224	280	L9	45	56
			de	252	318	3e3d	51	64
			G	280	355	L	56	71

* Tolerance of measurement of luminous intensity is $\pm 10\%$.

COLOR BIN LIMIT

Red (5 mA)			Green (5 mA)			Blue (5 mA)		
Bin Code	Min.(nm)	Max.(nm)	Bin Code	Min.(nm)	Max.(nm)	Bin Code	Min.(nm)	Max.(nm)
RB	619	624	G7	520	525	B3	460	465
			G23	522.5	527.5	B23	462.5	467.5
			G8	525	530	B4	465	470
			G45	527.5	532.5	B45	467.5	472.5
			G9	530	535	B5	470	475

* Tolerance of measurement of dominant wavelength is ± 1 nm.

ORDER CODE TABLE

Kit Number	Color	Luminous Intensity (mcd)		Dominant Wavelength (nm)				Package
		Min.	Max.	Color Bin	Min.(nm)	Color Bin	Max. (nm)	
CLMVC-FKA-CLBDGL7LBB79353	Red	56	112	RB	619	RB	624	Reel
	Green	140	355	G7	520	G9	535	Reel
	Blue	28	71	B3	460	B5	475	Reel
CLMVC-FKA-CL1D1L71BB7C3C3	Red	Any 1 Intensity bin from L(56) - B(112)		RB	619	RB	624	Reel
	Green	Any 1 Intensity bin from D(140) - G(355)		Any 1 hue bin from G7(520)-G9(535)				Reel
	Blue	Any 1 Intensity bin from L7(28) - L(71)		Any 1 hue bin from B3(460)-B5(475)				Reel
CLMVC-FKA-CA1E1L81BB7C3C3	Red	Any 1 Intensity bin from A(71) - B(112)		RB	619	RB	624	Reel
	Green	Any 1 Intensity bin from E(180) - G(355)		Any 1 hue bin from G7(520)-G9(535)				Reel
	Blue	Any 1 Intensity bin from L8(36) - L(71)		Any 1 hue bin from B3(460)-B5(475)				Reel

Notes:

- The above kit numbers represent order codes that include multiple intensity-bin and color-bin codes. Only one intensity-bin code and one color-bin code will be shipped on each bulk. Single intensity-bin code and single color-bin codes will not be orderable.
- Please refer to the [HB LED Lamp Reliability Test Standards](#) document for reliability test conditions.
- Please refer to the [HB LED Lamp Soldering & Handling](#) document for information about how to use this LED product safely.

GRAPHS

The data below are collected from statistical figures that do not necessarily correspond to the actual parameters of each single LED. Hence, these data will be changed without further notice.

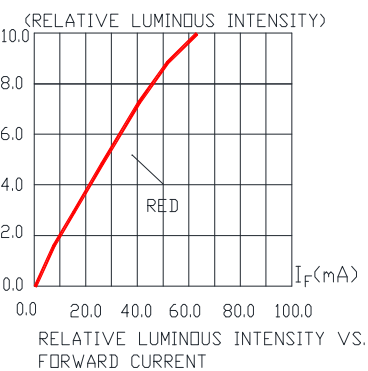
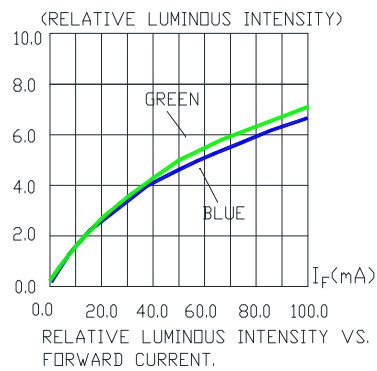
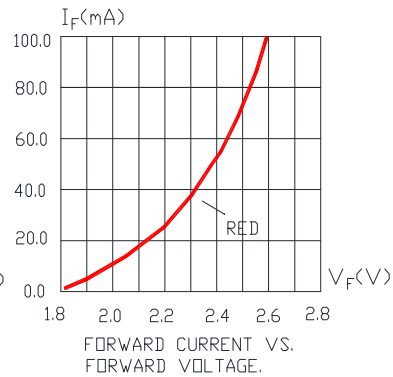
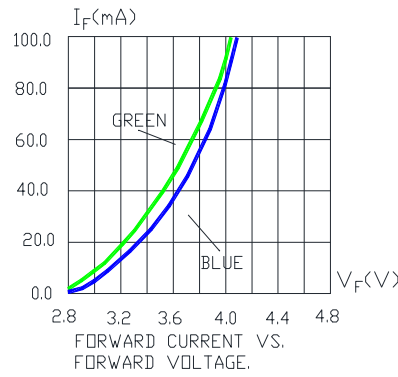
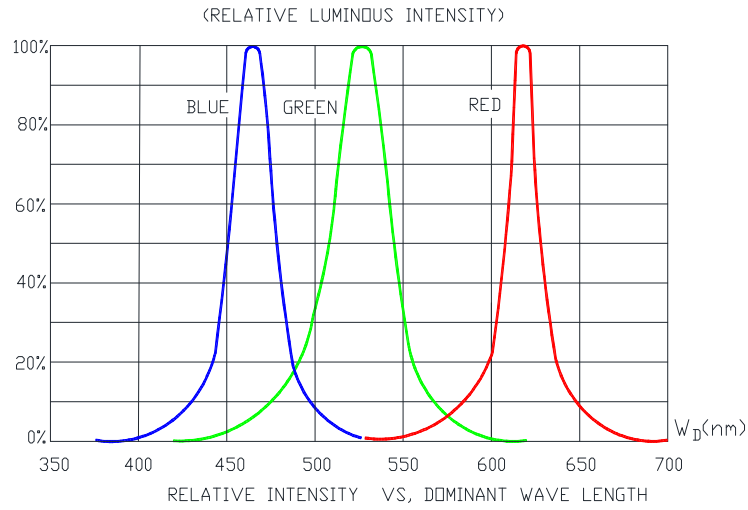

GRAPHS

The data below are collected from statistical figures that do not necessarily correspond to the actual parameters of each single LED. Hence, these data will be changed without further notice.

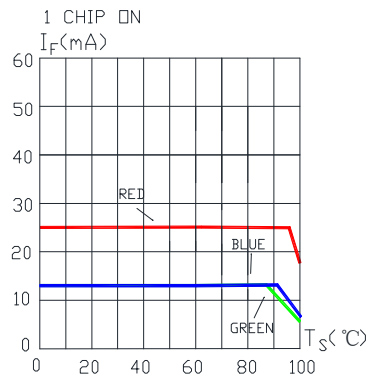
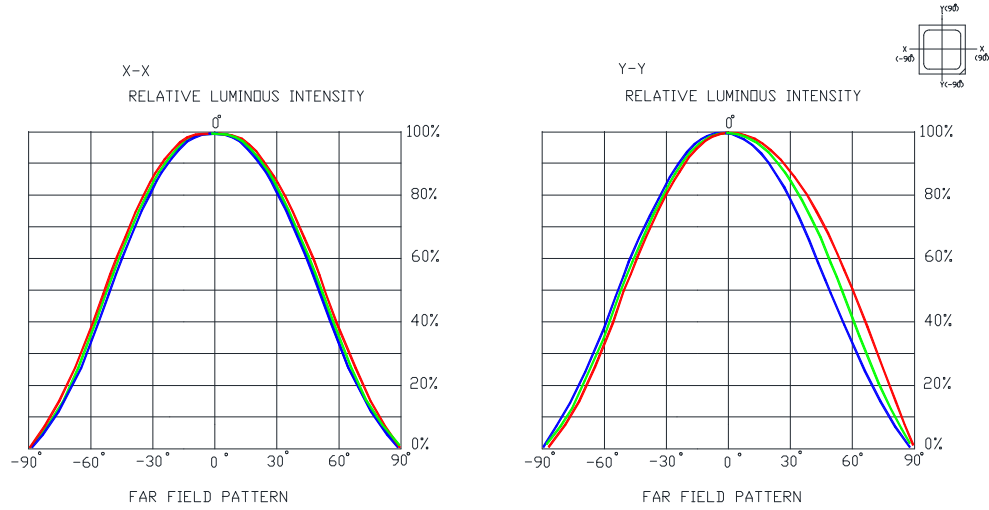

MAXIMUM FORWARD DC CURRENT VS. SOLDER POINT TEMPERATURE.

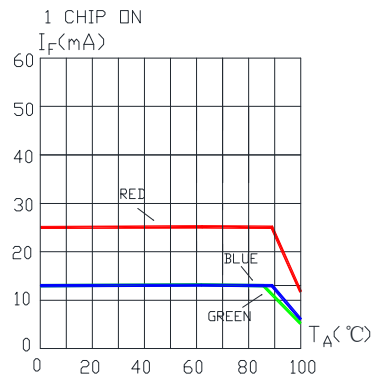

MAXIMUM FORWARD DC CURRENT VS. AMBIENT TEMPERATURE.

The graph shows the maximum allowable DC current for a LED die of each color.

MECHANICAL DIMENSIONS

All dimensions are in mm.

Tolerance of measurement of the dimension is ± 0.1 .

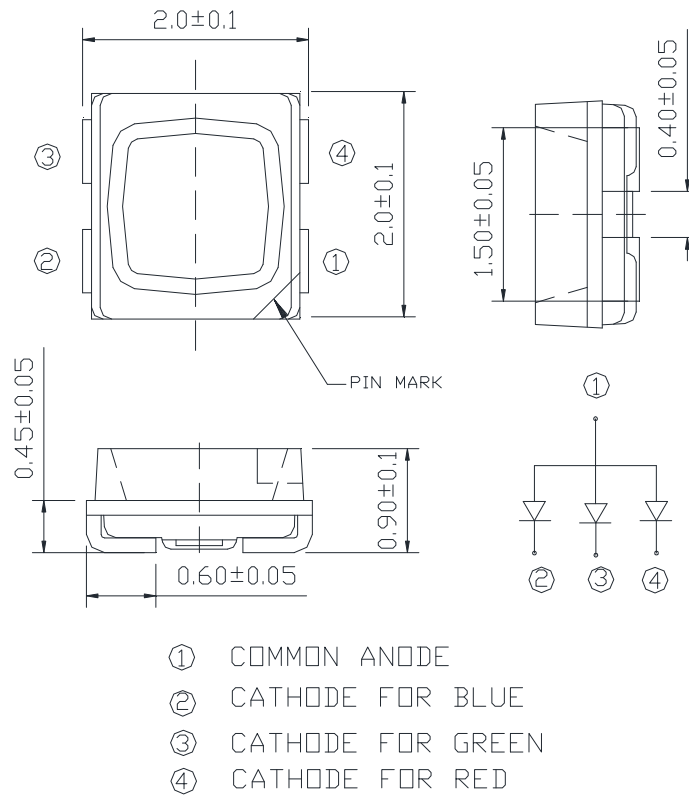

NOTES

RoHS Compliance

The levels of RoHS restricted materials in this product are below the maximum concentration values (also referred to as the threshold limits) permitted for such substances, or are used in an exempted application, in accordance with EU Directive 2011/65/EC (RoHS2), as implemented January 2, 2013. RoHS Declarations for this product can be obtained from your Cree LED representative or from the [Product Ecology](#) section of the Cree LED website.

Vision Advisory

WARNING: Do not look at an exposed lamp in operation. Eye injury can result.

KIT NUMBER SYSTEM

Cree LED lamps are tested and sorted into performance bins. A bin is specified by ranges of color, forward voltage, and brightness.

Cree LEDs are sold by order codes in combinations of bins called kits. Order codes are configured in the following manner:

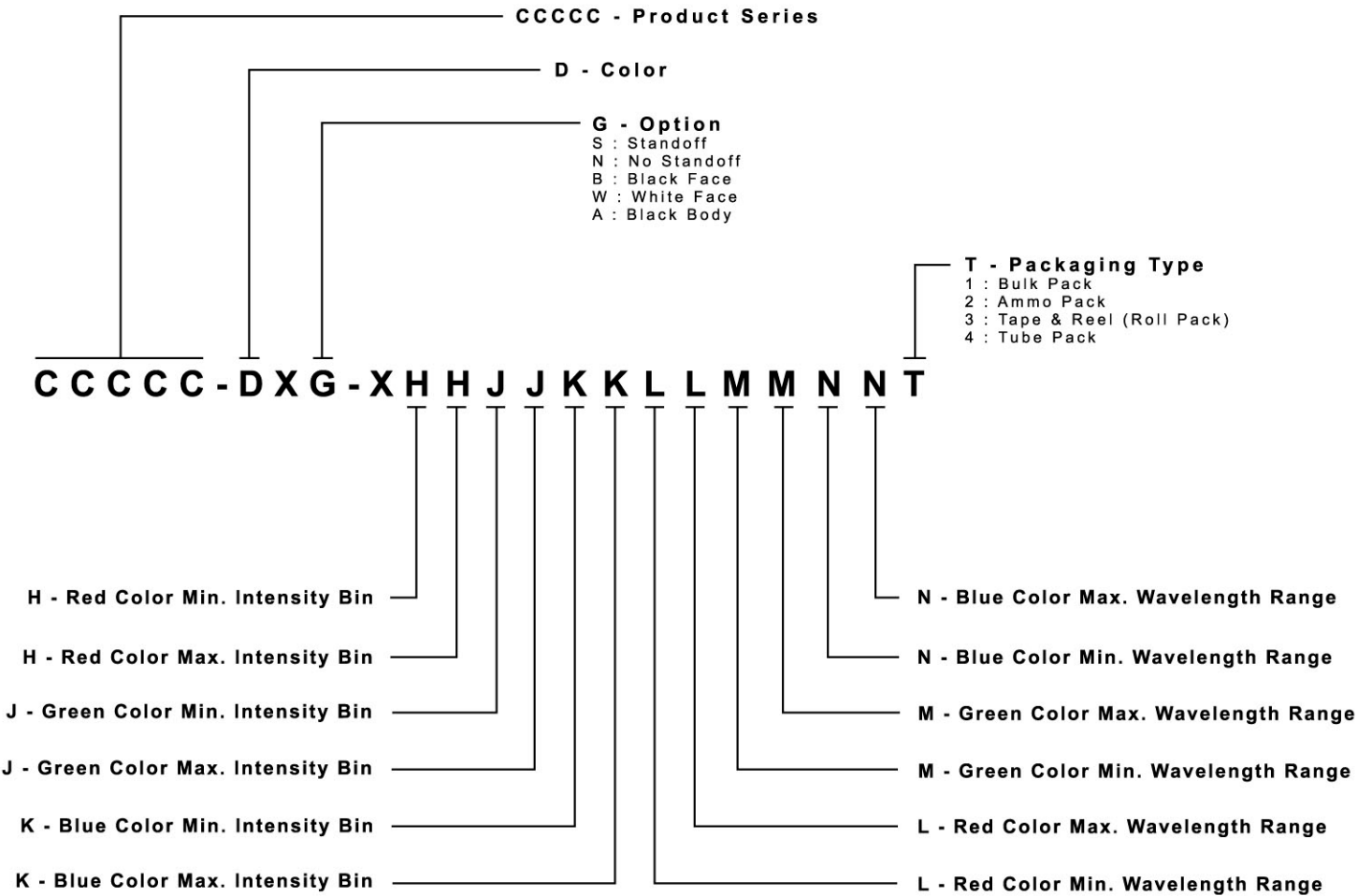

REFLOW SOLDERING

- The CLMVC-FKA is rated as a MSL 5a product.
- After opening the sealed bag, the SMD LED must be stored under the condition $<30^{\circ}\text{C}$ and $<60\%RH$. Under these conditions, the SMD LEDs must be used (subject to reflow) within 24 hours after bag opening, and baking 24-hour/ 80°C is required when exceeding 24 hours.
- Note that baking must only be done once.
- The temperature profile is as below.

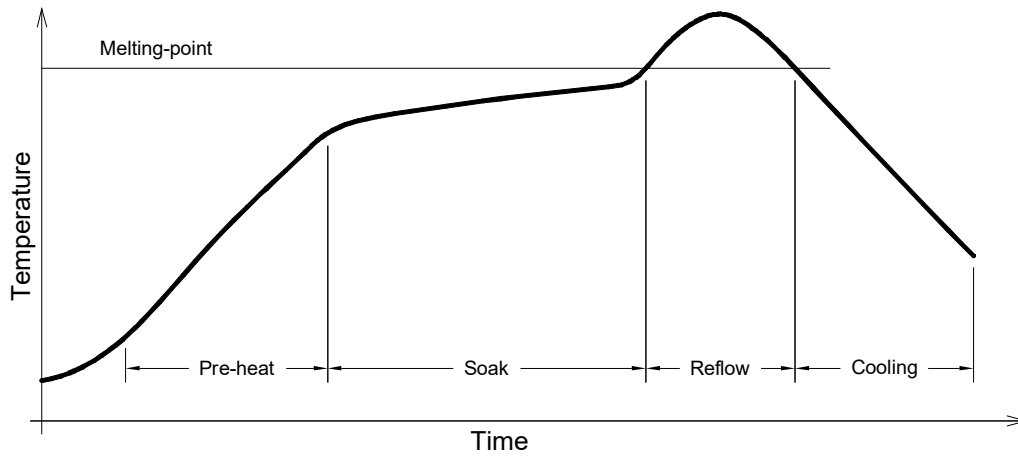

Use only with CLMVC-FKA

Solder
Average ramp-up rate = 4°C/s max
Preheat temperature = $150^{\circ}\text{C} \sim 200^{\circ}\text{C}$
Preheat time = 120s max
Ramp-down rate = 6°C/s max
Peak temperature = 235°C max
Time within 5°C of actual Peak Temperature = 10s max
Duration above 217°C is 45s max

Soldering pad:

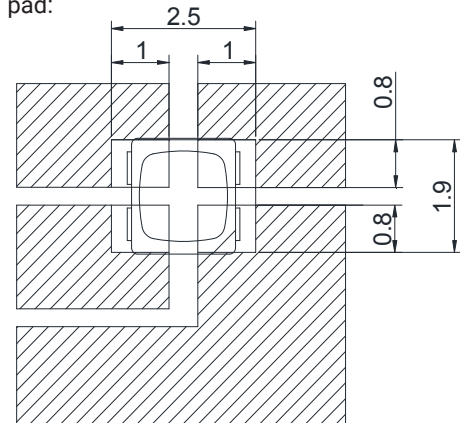

NOTES

- The packaging sizes of these SMD products are very small and the resin is still soft after solidification. Users are required to handle with care. Never touch the resin surface of SMD products.
- To avoid damaging the product's surface and interior device, it is recommended to choose a special nozzle to pick up the SMD products during the process of SMT production. If handling is necessary, take special care when picking up these products. The following method is necessary:

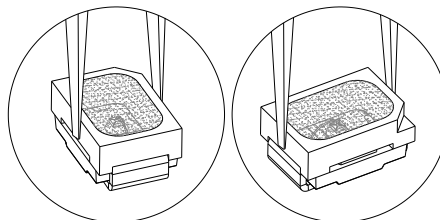

PACKAGING

- The boxes are not water resistant and they must be kept away from water and moisture.
- The LEDs are packed in cardboard boxes after packaging in normal or anti-electrostatic bags.
- Cardboard boxes will be used to protect the LEDs from mechanical shocks during transportation.
- The reel pack is applied in SMD LED.
- Max 12800 pcs per reel.

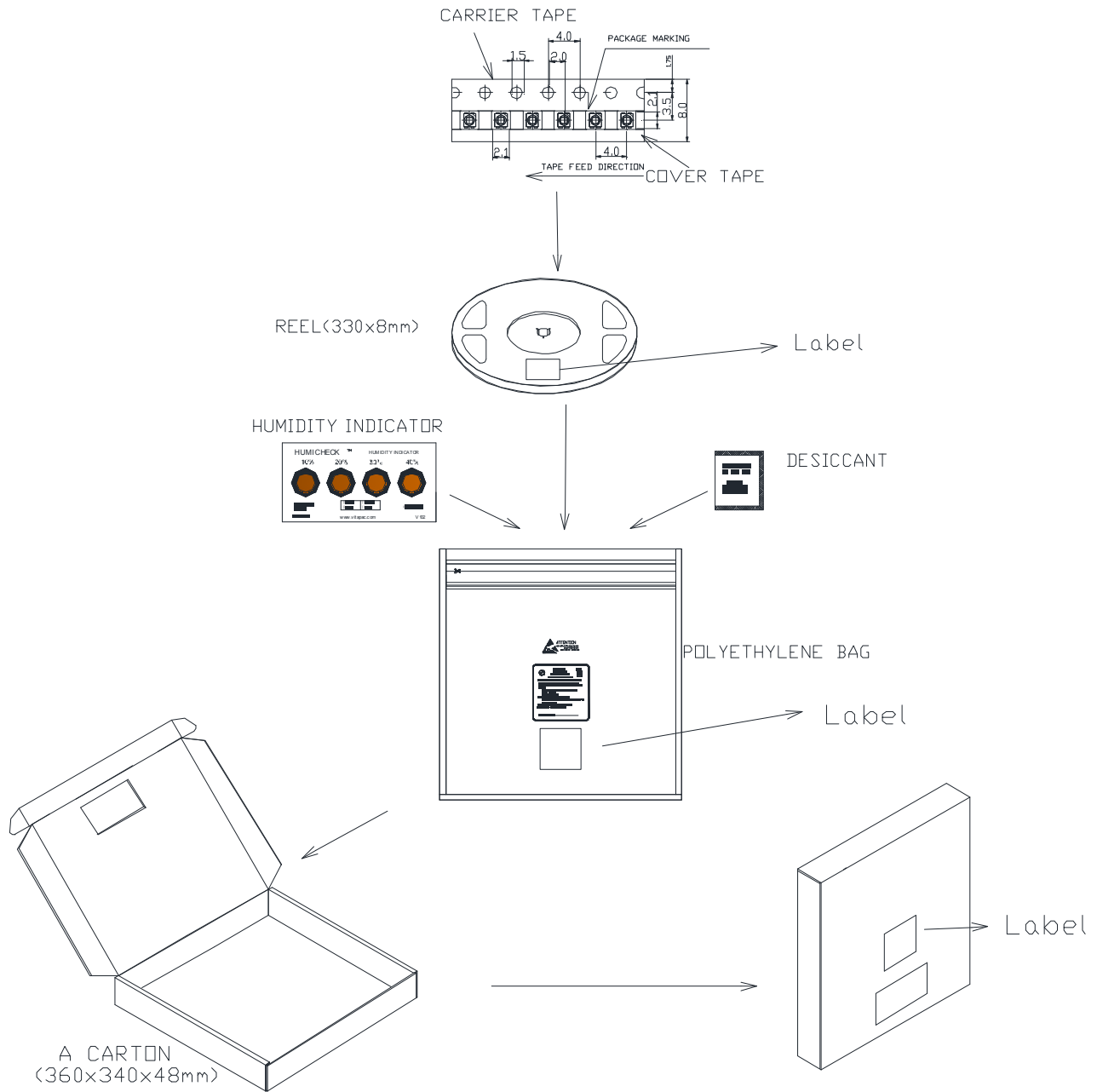

Mouser Electronics

Authorized Distributor

Click to View Pricing, Inventory, Delivery & Lifecycle Information:

[Cree LED:](#)

[CLMVC-FKA-CA1E1L81BB7C3C3](#) [CLMVC-FKA-CL1D1L71BB7C3C3](#) [CLMVC-FKA-CLBDGL7LBB79353](#)