

## Metallized Polypropylene Film Capacitor AC Capacitor MKP Type

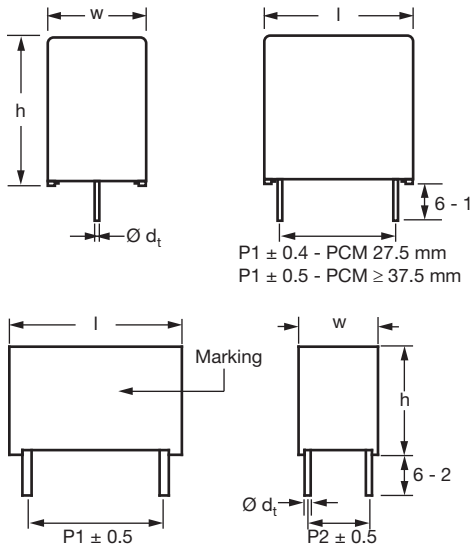

$\varnothing d_t \pm 10\%$  of standard diameter specified

### APPLICATIONS

High performance AC filtering applications

### REFERENCE STANDARDS

IEC 61071  
IEC 60068

### MARKING

C-value; tolerance; rated voltage; code for dielectric material; code for manufacturing origin; manufacturer's type designation; manufacturer's logo; year and week of manufacture

### DIELECTRIC

Polypropylene film

### ELECTRODES

Metallized dielectric film

### CONSTRUCTION

Mono construction

### ENCAPSULATION

Plastic case sealed with resin.  
Flame retardant

### TERMINALS

Tinned wires

### FEATURES

- Compliant to RoHS Directive 2002/95/EC

### RATED CAPACITANCE

1  $\mu$ F to 70  $\mu$ F

### CAPACITANCE TOLERANCE

$\pm 5\%$  and  $10\%$

### AC VOLTAGE RATING ( $V_{RMS}$ )

$U_N$	AC VOLTAGE AT 85 °C	AC VOLTAGE AT 105 °C
230 V	230 V	160 V
250 V	250 V	175 V
275 V	275 V	190 V
310 V	310 V	210 V
350 V	350 V	240 V
440 V	440 V	300 V

### INSULATION RESISTANCE

RC between leads, after 1 min > 10 000 s  
Measuring voltage 500 V

### SELF INDUCTANCE ( $L_s$ )

< 1 nH per mm of lead spacing

### WITHSTANDING DC VOLTAGE BETWEEN TERMINALS

1.5  $U_{NDC}$  for 10 s, cut off current 10 mA, rise time  $\leq 1000$  V/s  
See document "Voltage Test for Metallized Capacitors"  
[www.vishay.com/doc?28169](http://www.vishay.com/doc?28169)

### CLIMATIC TESTING CLASS

40/85/56

### MAXIMUM APPLICATION TEMPERATURE

105 °C

### MAXIMUM OPERATING TEMPERATURE (CASE)

105 °C

### LIFETIME EXPECTANCY

Useful lifetime expectancy: > 60 000 h at  $U_N$

FIT: <  $10 \times 10^{-9}/h$  (10 per  $10^9$  component hours) at  $0.5 \times U_N$   
40 °C

### DETAILED SPECIFICATION

For more detailed data and test requirements contact:  
[dc-film@vishay.com](mailto:dc-film@vishay.com)

### GENERAL INFORMATION

Characteristics and definitions used for film capacitors  
[www.vishay.com/docs?28147/intro.pdf](http://www.vishay.com/docs?28147/intro.pdf)



RoHS  
COMPLIANT

# MKP1847 AC Capacitors



Vishay Roederstein

Metallized Polypropylene Film Capacitor  
AC Capacitor MKP Type

## COMPOSITION OF CATALOG NUMBER

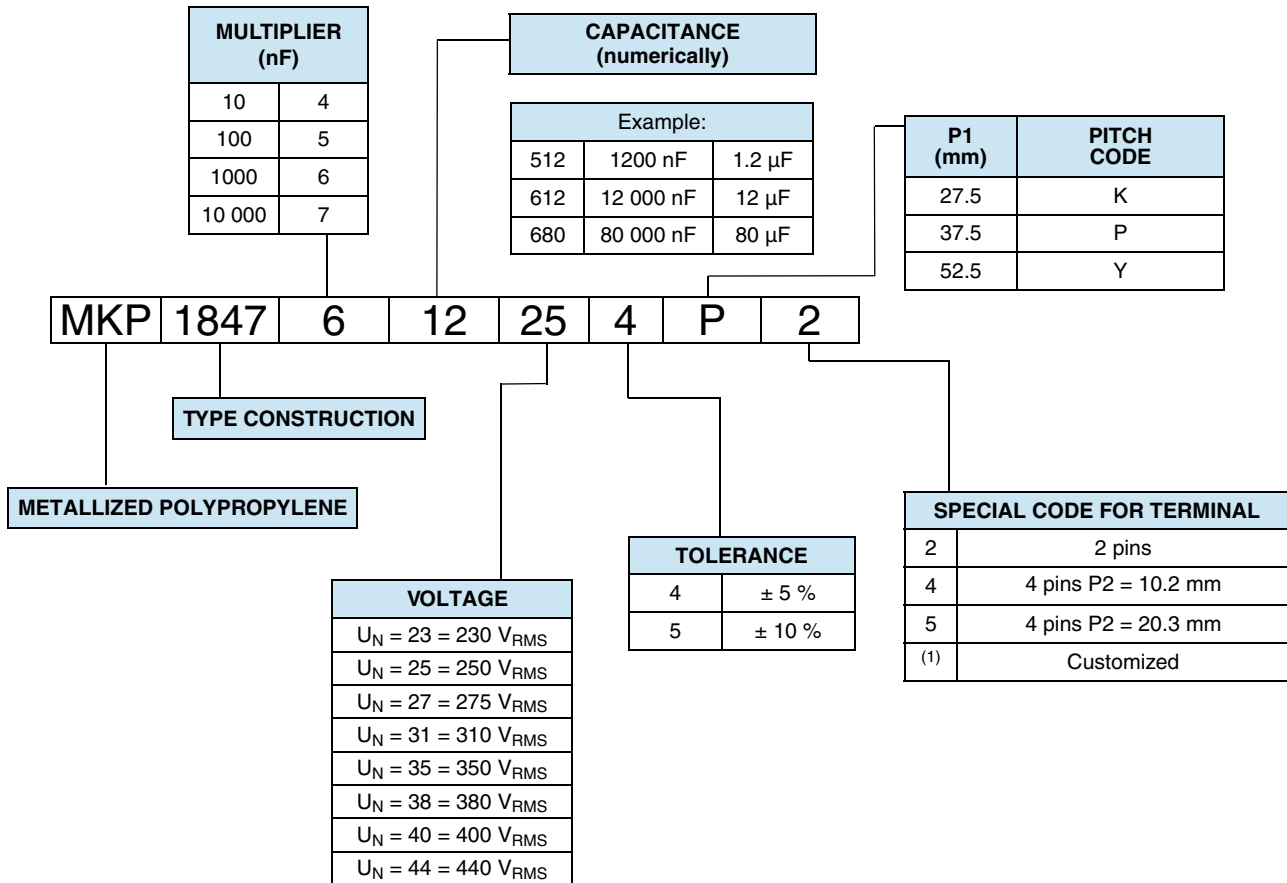

**Note**

(1) Tabs terminals or customized terminals are available on request



# MKP1847 AC Capacitors

Metallized Polypropylene Film Capacitor  
AC Capacitor MKP Type

Vishay Roederstein

## SPECIFIC REFERENCE DATA 230 V<sub>RMS</sub>

U<sub>N</sub> = 230 V<sub>AC</sub>, U<sub>NDC</sub> = 450 V

CAP. (1)	DIMENSIONS (2) (mm)			P1	P2	Ø d <sub>t</sub>	dU/dt (3)	I <sub>PEAK</sub>	I <sub>RMS</sub> (4) (A)		tan δ (5) 1 kHz < (10 <sup>-4</sup> )		tan δ (5) 10 kHz < (10 <sup>-4</sup> )		MASS ≈ (g)	SPQ (6) (pcs)	PART NUMBER (7)
	(µF)	w	h						l	(mm)	(mm)	(mm)	(V/µs)	(A)			
1	9.0	19.0	32.0	27.5	-	0.8	45	45	2.5		4.5	-	30	-	6	160	MKP1847510234K2
2	11.0	21.0	32.0	27.5	-	0.8	45	90	3.5		4.5	-	30	-	9	130	MKP1847520234K2
3	13.0	23.0	32.0	27.5	-	0.8	45	135	5.0		4.5	-	30	-	11	115	MKP1847530234K2
4	15.0	25.0	32.0	27.5	-	0.8	45	180	6.0		4.5	-	30	-	12	100	MKP1847540234K2
5	18.0	28.0	32.0	27.5	-	0.8	45	225	7.5		4.5	-	30	-	17	80	MKP1847550234K2
6	18.0	28.0	32.0	27.5	-	0.8	45	270	8.0		4.5	-	30	-	16	80	MKP1847560234K2
7	18.0	28.0	32.0	27.5	-	0.8	45	315	8.5		4.5	-	30	-	15	80	MKP1847570234K2
8	21.0	31.0	32.0	27.5	-	0.8	45	360	10.0		4.5	-	30	-	22	65	MKP1847580234K2
9	21.0	31.0	32.0	27.5	-	0.8	45	405	10.5		4.5	-	30	-	21	65	MKP1847590234K2
10	20.0	35.0	32.0	27.5	-	0.8	45	450	11.5		4.5	-	30	-	21	70	MKP1847610234K2
10	18.5	35.5	43.0	37.5	10.2	1.0	20	200	8.0	9.0	10	8.5	75	68	32	105	MKP1847610234P*
12	18.5	35.5	43.0	37.5	10.2	1.0	20	240	9.0	10.0	10	8.5	75	68	30	105	MKP1847612234P*
15	21.5	38.5	43.0	37.5	10.2	1.0	20	300	11.0	12.0	10	8.5	75	68	37	91	MKP1847615234P*
20	24.0	44.0	42.0	37.5	10.2	1.0	20	400	13.5	14.5	10	8.5	75	68	48	77	MKP1847620234P*
22	24.0	44.0	42.0	37.5	10.2	1.0	20	440	14.0	15.5	10	8.5	75	68	45	77	MKP1847622234P*
25	30.0	45.0	42.0	37.5	10.2/20.3	1.0	20	500	16.0	17.5	10	8.5	75	68	62	63	MKP1847625234P*
30	30.0	45.0	42.0	37.5	10.2/20.3	1.0	20	600	17.5	19.0	10	8.5	75	68	56	63	MKP1847630234P*
30	25.0	45.0	57.5	52.5	10.2	1.2	10	300	13.5	15.0	20	17	150	135	69	55	MKP1847630234Y*
35	25.0	45.0	57.5	52.5	10.2	1.2	10	350	14.5	16.0	20	17	150	135	65	55	MKP1847635234Y*
40	30.0	45.0	57.5	52.5	20.3	1.2	10	400	16.5	18.0	20	17	150	135	91	45	MKP1847640234Y*
45	30.0	45.0	57.5	52.5	20.3	1.2	10	450	17.5	19.0	20	17	150	135	86	45	MKP1847645234Y*
50	35.0	50.0	57.5	52.5	20.3	1.2	10	500	20.0	21.5	20	17	150	135	107	40	MKP1847650234Y*
55	35.0	50.0	57.5	52.5	20.3	1.2	10	550	21.0	22.5	20	17	150	135	101	40	MKP1847655234Y*
60	35.0	50.0	57.5	52.5	20.3	1.2	10	600	21.5	23.5	20	17	150	135	96	40	MKP1847660234Y*
65	45.0	45.0	57.5	52.5	20.3	1.2	10	650	-	25.5	-	17	-	135	121	30	MKP1847665234Y5
70	45.0	45.0	57.5	52.5	20.3	1.2	10	700	-	26.0	-	17	-	135	120	30	MKP1847670235Y5

### Notes

- (1) Intermediate capacitance values are available on request
- (2) Standard dimension
- (3) Rated voltage pulse slope (dU/dt) R at voltage U<sub>NDC</sub>
- (4) Maximum RMS current at 10 kHz, + 85 °C, Capacitance tolerance specified
- (5) The ESR (Equivalent Series Resistance) can be calculated as tan δ (f)/(2 x π x f x C)
- (6) SPQ = Standard Packing Quantity
- (7) Change the \* symbols with special code for terminals

# MKP1847 AC Capacitors



Vishay Roederstein

Metallized Polypropylene Film Capacitor  
AC Capacitor MKP Type

## SPECIFIC REFERENCE DATA 250 V<sub>RMS</sub>

U<sub>N</sub> = 250 V<sub>AC</sub>, U<sub>NDC</sub> = 500 V

CAP. (1)	DIMENSIONS (2)			P1	P2	Ø d <sub>t</sub>	dU/dt (3)	I <sub>PEAK</sub>	I <sub>RMS</sub> (4)		tan δ (5)		tan δ (5)		MASS	SPQ (6)	PART NUMBER (7)
	(µF)	w	h						l	(mm)	(mm)	(mm)	(V/µs)	(A)			
1	9.0	19.0	32.0	27.5	-	0.8	50	50	3.5	-	4	-	28	-	6	160	MKP1847510254K2
2	11.0	21.0	32.0	27.5	-	0.8	50	100	4.5	-	4	-	28	-	9	130	MKP1847520254K2
3	13.0	23.0	32.0	27.5	-	0.8	50	150	6.0	-	4	-	28	-	10	115	MKP1847530254K2
4	15.0	25.0	32.0	27.5	-	0.8	50	200	7.0	-	4	-	28	-	12	100	MKP1847540254K2
5	18.0	28.0	32.0	27.5	-	0.8	50	250	9.0	-	4	-	28	-	16	80	MKP1847550254K2
6	18.0	28.0	32.0	27.5	-	0.8	50	300	9.5	-	4	-	28	-	15	80	MKP1847560254K2
7	21.0	31.0	32.0	27.5	-	0.8	50	350	11.0	-	4	-	28	-	22	65	MKP1847570254K2
8	21.0	31.0	32.0	27.5	-	0.8	50	400	12.0	-	4	-	28	-	21	65	MKP1847580254K2
9	20.0	35.0	32.0	27.5	-	0.8	50	450	13.0	-	4	-	28	-	20	70	MKP1847590254K2
5	18.5	35.5	43.0	37.5	10.2	1.0	25	125	7.0	8.0	8.5	7	70	65	36	105	MKP1847550254P*
6	18.5	35.5	43.0	37.5	10.2	1.0	25	150	7.5	8.5	8.5	7	70	65	35	105	MKP1847560254P*
7	18.5	35.5	43.0	37.5	10.2	1.0	25	175	8.0	9.0	8.5	7	70	65	34	105	MKP1847570254P*
8	18.5	35.5	43.0	37.5	10.2	1.0	25	200	9.0	10.0	8.5	7	70	65	32	105	MKP1847580254P*
9	18.5	35.5	43.0	37.5	10.2	1.0	25	225	9.5	10.5	8.5	7	70	65	31	105	MKP1847590254P*
10	18.5	35.5	43.0	37.5	10.2	1.0	25	250	10.0	11.0	8.5	7	70	65	30	105	MKP1847610254P*
12	18.5	35.5	43.0	37.5	10.2	1.0	25	300	11.0	12.0	8.5	7	70	65	27	105	MKP1847612254P*
15	21.5	38.5	43.0	37.5	10.2	1.0	25	375	13.0	14.0	8.5	7	70	65	34	91	MKP1847615254P*
20	30.0	45.0	42.0	37.5	10.2/20.3	1.0	25	500	17.0	18.5	8.5	7	70	65	63	63	MKP1847620254P*
22	30.0	45.0	42.0	37.5	10.2/20.3	1.0	25	550	18.0	19.5	8.5	7	70	65	61	63	MKP1847622254P*
25	30.0	45.0	42.0	37.5	10.2/20.3	1.0	25	625	19.0	21.0	8.5	7	70	65	57	63	MKP1847625254P*
15	25.0	45.0	57.5	52.5	10.2	1.2	12	180	11.5	12.5	16	14	135	125	83	55	MKP1847615254Y*
20	25.0	45.0	57.5	52.5	10.2	1.2	12	240	13.5	14.5	16	14	135	125	77	55	MKP1847620254Y*
22	25.0	45.0	57.5	52.5	10.2	1.2	12	264	14.0	15.5	16	14	135	125	75	55	MKP1847622254Y*
25	25.0	45.0	57.5	52.5	10.2	1.2	12	300	15.0	16.5	16	14	135	125	71	55	MKP1847625254Y*
30	30.0	45.0	57.5	52.5	20.3	1.2	12	360	17.0	18.5	16	14	135	125	97	45	MKP1847630254Y*
35	30.0	45.0	57.5	52.5	20.3	1.2	12	420	18.5	20.0	16	14	135	125	91	45	MKP1847635254Y*
40	35.0	50.0	57.5	52.5	20.3	1.2	12	480	21.5	23.0	16	14	135	125	111	40	MKP1847640254Y*
45	35.0	50.0	57.5	52.5	20.3	1.2	12	540	22.5	24.5	16	14	135	125	105	40	MKP1847645254Y*
50	35.0	50.0	57.5	52.5	20.3	1.2	12	600	23.5	26.0	16	14	135	125	98	40	MKP1847650254Y*
55	45.0	45.0	57.5	52.5	20.3	1.2	12	660	-	28.5	-	14	-	125	123	30	MKP1847655254Y5
60	45.0	45.0	57.5	52.5	20.3	1.2	12	720	-	29.0	-	14	-	125	120	30	MKP1847660255Y5

### Notes

- (1) Intermediate capacitance values are available on request
- (2) Standard dimension
- (3) Rated voltage pulse slope (dU/dt) R at voltage U<sub>NDC</sub>
- (4) Maximum RMS current at 10 kHz, + 85 °C, Capacitance tolerance specified
- (5) The ESR (Equivalent Series Resistance) can be calculated as  $\tan \delta (f)/(2 \times \pi \times f \times C)$
- (6) SPQ = Standard Packing Quantity
- (7) Change the \* symbols with special code for terminals



# MKP1847 AC Capacitors

Metallized Polypropylene Film Capacitor  
AC Capacitor MKP Type

Vishay Roederstein

## SPECIFIC REFERENCE DATA 275 V<sub>RMS</sub>

U<sub>N</sub> = 275 V<sub>AC</sub>, U<sub>NDC</sub> = 600 V

CAP. (1)	DIMENSIONS (2) (mm)			P1	P2	Ø d <sub>t</sub>	dU/dt (3)	I <sub>PEAK</sub>	I <sub>RMS</sub> (4) (A)		tan δ (5) 1 kHz < (10 <sup>-4</sup> )		tan δ (5) 10 kHz < (10 <sup>-4</sup> )		MASS ≈ (g)	SPQ (6) (pcs)	PART NUMBER (7)
	(µF)	w	h						l	(mm)	(mm)	(mm)	(V/µs)	(A)			
1	9.0	19.0	32.0	27.5	-	0.8	55	55	3.5	-	4	-	25	-	6	160	MKP1847510274K2
2	13.0	23.0	32.0	27.5	-	0.8	55	110	5.0	-	4	-	25	-	11	115	MKP1847520274K2
3	15.0	25.0	32.0	27.5	-	0.8	55	165	6.5	-	4	-	25	-	12	100	MKP1847530274K2
4	18.0	28.0	32.0	27.5	-	0.8	55	220	8.5	-	4	-	25	-	16	80	MKP1847540274K2
5	21.0	31.0	32.0	27.5	-	0.8	55	275	10.0	-	4	-	25	-	22	65	MKP1847550274K2
6	21.0	31.0	32.0	27.5	-	0.8	55	330	11.0	-	4	-	25	-	21	65	MKP1847560274K2
7	20.0	35.0	32.0	27.5	-	0.8	55	385	12.0	-	4	-	25	-	20	70	MKP1847570274K2
5	18.5	35.5	43.0	37.5	10.2	1.0	30	150	7.5	8.5	7.5	6.5	65	55	34	105	MKP1847550274P*
6	18.5	35.5	43.0	37.5	10.2	1.0	30	180	8.0	9.0	7.5	6.5	65	55	33	105	MKP1847560274P*
7	18.5	35.5	43.0	37.5	10.2	1.0	30	210	9.0	10.0	7.5	6.5	65	55	31	105	MKP1847570274P*
8	18.5	35.5	43.0	37.5	10.2	1.0	30	240	9.5	10.5	7.5	6.5	65	55	30	105	MKP1847580274P*
9	18.5	35.5	43.0	37.5	10.2	1.0	30	270	10.0	11.0	7.5	6.5	65	55	28	105	MKP1847590274P*
10	21.5	38.5	43.0	37.5	10.2	1.0	30	300	11.0	12.5	7.5	6.5	65	55	37	91	MKP1847610274P*
12	21.5	38.5	43.0	37.5	10.2	1.0	30	360	12.5	13.5	7.5	6.5	65	55	34	91	MKP1847612274P*
15	24.0	44.0	42.0	37.5	10.2	1.0	30	450	14.5	16.0	7.5	6.5	65	55	45	77	MKP1847615274P*
20	30.0	45.0	42.0	37.5	10.2/ 20.3	1.0	30	600	18.0	20.0	7.5	6.5	65	55	56	63	MKP1847620274P*
15	25.0	45.0	57.5	52.5	10.2	1.2	13	195	12.5	13.5	14	12	125	105	78	55	MKP1847615274Y*
20	25.0	45.0	57.5	52.5	10.2	1.2	13	260	14.0	15.5	14	12	125	105	70	55	MKP1847620274Y*
22	25.0	45.0	57.5	52.5	10.2	1.2	13	286	15.0	16.0	14	12	125	105	67	55	MKP1847622274Y*
25	30.0	45.0	57.5	52.5	20.3	1.2	13	325	16.5	18.0	14	12	125	105	95	45	MKP1847625274Y*
30	30.0	45.0	57.5	52.5	20.3	1.2	13	390	18.0	20.0	14	12	125	105	86	45	MKP1847630274Y*
35	35.0	50.0	57.5	52.5	20.3	1.2	13	455	21.0	23.0	14	12	125	105	106	40	MKP1847635274Y*
40	35.0	50.0	57.5	52.5	20.3	1.2	13	520	22.5	24.5	14	12	125	105	96	40	MKP1847640274Y*
45	45.0	45.0	57.5	52.5	20.3	1.2	13	585	-	27.5	-	12	125	105	186	30	MKP1847645274Y5
50	45.0	45.0	57.5	52.5	20.3	1.2	13	650	-	28.0	-	12	125	105	186	30	MKP1847650275Y5

### Notes

- (1) Intermediate capacitance values are available on request
- (2) Standard dimension
- (3) Rated voltage pulse slope (dU/dt) R at voltage U<sub>NDC</sub>
- (4) Maximum RMS current at 10 kHz, + 85 °C, Capacitance tolerance specified
- (5) The ESR (Equivalent Series Resistance) can be calculated as tan δ (f)/(2 x π x f x C)
- (6) SPQ = Standard Packing Quantity
- (7) Change the \* symbols with special code for terminals

# MKP1847 AC Capacitors



Vishay Roederstein

Metallized Polypropylene Film Capacitor  
AC Capacitor MKP Type

## SPECIFIC REFERENCE DATA 310 V<sub>RMS</sub>

U<sub>N</sub> = 310 V<sub>AC</sub>, U<sub>NDC</sub> = 630 V

CAP. (1)	DIMENSIONS (2) (mm)			P1	P2	Ø d <sub>t</sub>	dU/dt (3)	I <sub>PEAK</sub>	I <sub>RMS</sub> (4)		tan δ (5) 1 kHz < (10 <sup>-4</sup> )		tan δ (5) 10 kHz < (10 <sup>-4</sup> )		MASS ≈ (g)	SPQ (6)	PART NUMBER (7)
	(µF)	w	h						l	(mm)	(mm)	(mm)	(V/µs)	(A)			
1	11.0	21.0	32.0	27.5	-	0.8	68	68	4.5	-	3.5	-	20	-	9	130	MKP1847510314K2
2	15.0	25.0	32.0	27.5	-	0.8	68	136	7.5	-	3.5	-	20	-	12	100	MKP1847520314K2
3	18.0	28.0	32.0	27.5	-	0.8	68	204	9.5	-	3.5	-	20	-	16	80	MKP1847530314K2
4	21.0	31.0	32.0	27.5	-	0.8	68	272	12.0	-	3.5	-	20	-	22	65	MKP1847540314K2
5	21.0	31.0	32.0	27.5	-	0.8	68	340	13.5	-	3.5	-	20	-	20	65	MKP1847550314K2
5	18.5	35.5	43.0	37.5	10.2	1.0	35	175	10.0	11.0	7	6	55	48	32	105	MKP1847550314P*
6	18.5	35.5	43.0	37.5	10.2	1.0	35	210	11.0	12.0	7	6	55	48	30	105	MKP1847560314P*
7	18.5	35.5	43.0	37.5	10.2	1.0	35	245	12.0	13.0	7	6	55	48	28	105	MKP1847570314P*
8	21.5	38.5	43.0	37.5	10.2	1.0	35	280	13.5	15.0	7	6	55	48	37	91	MKP1847580314P*
9	21.5	38.5	43.0	37.5	10.2	1.0	35	315	14.5	15.5	7	6	55	48	35	91	MKP1847590314P*
10	21.5	38.5	43.0	37.5	10.2	1.0	35	350	14.5	16.0	7	6	55	48	34	91	MKP1847610315P*
12	24.0	44.0	42.0	37.5	10.2	1.0	35	420	17.5	19.5	7	6	55	48	44	77	MKP1847612314P*
15	30.0	45.0	42.0	37.5	10.2/ 20.3	1.0	35	525	21.0	23.0	7	6	55	48	58	63	MKP1847615314P*
10	25.0	45.0	57.5	52.5	10.2	1.2	15	150	13.5	14.5	12	10	105	90	81	55	MKP1847610314Y*
12	25.0	45.0	57.5	52.5	10.2	1.2	15	180	14.5	16.0	12	10	105	90	77	55	MKP1847612314Y*
15	25.0	45.0	57.5	52.5	10.2	1.2	15	225	16.5	18.0	12	10	105	90	71	55	MKP1847615314Y*
20	30.0	45.0	57.5	52.5	20.3	1.2	15	300	19.5	21.5	12	10	105	90	93	45	MKP1847620314Y*
22	35.0	50.0	57.5	52.5	20.3	1.2	15	330	22.5	24.5	12	10	105	90	117	40	MKP1847622314Y*
25	35.0	50.0	57.5	52.5	20.3	1.2	15	375	24.0	26.0	12	10	105	90	111	40	MKP1847625314Y*
30	45.0	45.0	57.5	52.5	20.3	1.2	15	450	-	29.5	-	10	-	90	187	30	MKP1847630314Y5
35	45.0	45.0	57.5	52.5	20.3	1.2	15	525	-	32.0	-	10	-	90	187	30	MKP1847635314Y5

### Notes

- (1) Intermediate capacitance values are available on request
- (2) Standard dimension
- (3) Rated voltage pulse slope (dU/dt) R at voltage U<sub>NDC</sub>
- (4) Maximum RMS current at 10 kHz, + 85 °C, Capacitance tolerance specified
- (5) The ESR (Equivalent Series Resistance) can be calculated as  $\tan \delta (f)/(2 \times \pi \times f \times C)$
- (6) SPQ = Standard Packing Quantity
- (7) Change the \* symbols with special code for terminals



# MKP1847 AC Capacitors

Metallized Polypropylene Film Capacitor  
AC Capacitor MKP Type

Vishay Roederstein

## SPECIFIC REFERENCE DATA 350 V<sub>RMS</sub>

U<sub>N</sub> = 350 V<sub>AC</sub>, U<sub>NDC</sub> = 700 V

CAP. (1)	DIMENSIONS (2) (mm)			P1	P2	Ø d <sub>t</sub>	dU/dt (3)	I <sub>PEAK</sub>	I <sub>RMS</sub> (4) (A)		tan δ (5) 1 kHz < (10 <sup>-4</sup> )		tan δ (5) 10 kHz < (10 <sup>-4</sup> )		MASS ≈ (g)	SPQ (6) (pcs)	PART NUMBER (7)
	(µF)	w	h						l	(mm)	(mm)	(mm)	(V/µs)	(A)			
1	11.0	21.0	32.0	27.5	-	0.8	100	100	4.5	-	3	-	18	-	9	130	MKP1847510354K2
2	15.0	25.0	32.0	27.5	-	0.8	100	200	7.5	-	3	-	18	-	12	100	MKP1847520354K2
3	18.0	28.0	32.0	27.5	-	0.8	100	300	10.0	-	3	-	18	-	15	80	MKP1847530354K2
4	21.0	31.0	32.0	27.5	-	0.8	100	400	12.5	-	3	-	18	-	21	65	MKP1847540354K2
5	18.5	35.5	43.0	37.5	10.2	1.0	50	250	10.5	11.5	6.5	5.5	50	45	30	105	MKP1847550354P*
6	18.5	35.5	43.0	37.5	10.2	1.0	50	300	11.5	12.5	6.5	5.5	50	45	28	105	MKP1847560354P*
7	21.5	38.5	43.0	37.5	10.2	1.0	50	350	13.0	14.5	6.5	5.5	50	45	37	91	MKP1847570354P*
8	21.5	38.5	43.0	37.5	10.2	1.0	50	400	14.0	15.5	6.5	5.5	50	45	34	91	MKP1847580354P*
9	24.0	44.0	42.0	37.5	10.2	1.0	50	450	16.0	17.5	6.5	5.5	50	45	48	77	MKP1847590354P*
10	24.0	44.0	42.0	37.5	10.2	1.0	50	500	16.5	18.0	6.5	5.5	50	45	45	77	MKP1847610354P*
12	30.0	45.0	42.0	37.5	10.2/ 20.3	1.0	50	600	19.5	21.5	6.5	5.5	50	45	60	63	MKP1847612354P*
10	25.0	45.0	57.5	52.5	10.2	1.2	25	250	14.0	15.0	11	9.5	100	85	78	55	MKP1847610354Y*
12	25.0	45.0	57.5	52.5	10.2	1.2	25	300	15.0	16.5	11	9.5	100	85	74	55	MKP1847612354Y*
15	25.0	45.0	57.5	52.5	10.2	1.2	25	375	17.0	18.5	11	9.5	100	85	67	55	MKP1847615354Y*
20	30.0	45.0	57.5	52.5	20.3	1.2	25	500	20.5	22.0	11	9.5	100	85	87	45	MKP1847620354Y*
22	35.0	50.0	57.5	52.5	20.3	1.2	25	550	23.0	25.0	11	9.5	100	85	111	40	MKP1847622354Y*
25	35.0	50.0	57.5	52.5	20.3	1.2	25	625	24.5	26.5	11	9.5	100	85	102	40	MKP1847625354Y*
30	45.0	45.0	57.5	52.5	20.3	1.2	25	750	-	30.5	-	9.5	-	85	187	30	MKP1847630354Y5

### Notes

- (1) Intermediate capacitance values are available on request
- (2) Standard dimension
- (3) Rated voltage pulse slope (dU/dt) R at voltage U<sub>NDC</sub>
- (4) Maximum RMS current at 10 kHz, + 85 °C, Capacitance tolerance specified
- (5) The ESR (Equivalent Series Resistance) can be calculated as tan δ (f)/(2 x π x f x C)
- (6) SPQ = Standard Packing Quantity
- (7) Change the \* symbols with special code for terminals

# MKP1847 AC Capacitors



Vishay Roederstein

Metallized Polypropylene Film Capacitor  
AC Capacitor MKP Type

## SPECIFIC REFERENCE DATA (under development)

$U_N = 440 V_{AC}$ ,  $U_{NDC} = 1000 V$

CAP. (1)	DIMENSIONS (2)			P1	P2	Ø d <sub>t</sub>	dU/dt (3)	I <sub>PEAK</sub>	I <sub>RMS</sub> (4)		tan δ (5)		tan δ (5)		MASS	SPQ (6)	PART NUMBER (7)
	(µF)	w	h						l	(mm)	(mm)	(mm)	(V/µs)	(A)			
1	18.5	35.5	43.0	37.5	10.2	1.0	80	80	6.0	7.0	3.5	3.0	15	13	42	105	MKP1847510444P*
1.5	18.5	35.5	43.0	37.5	10.2	1.0	80	120	7.0	8.0	3.5	3.0	15	13	40	105	MKP1847515444P*
2	24.0	44.0	42.0	37.5	10.2	1.0	80	160	10.0	11.0	3.5	3.0	15	13	65	77	MKP1847520444P*
2.2	24.0	44.0	42.0	37.5	10.2	1.0	80	176	10.0	11.0	3.5	3.0	15	13	64	77	MKP1847522444P*
2.7	24.0	44.0	42.0	37.5	10.2	1.0	80	216	12.0	12.5	3.5	3.0	15	13	61	77	MKP1847527444P*
3	30.0	45.0	42.0	37.5	10.2/20.3	1.0	80	240	13.0	14.0	3.5	3.0	15	13	78	63	MKP1847530444P*
3.3	30.0	45.0	42.0	37.5	10.2/20.3	1.0	80	264	14.0	15.0	3.5	3.0	15	13	75	63	MKP1847533444P*
4	30.0	45.0	42.0	37.5	10.2/20.3	1.0	80	320	15.0	16.0	3.5	3.0	15	13	69	63	MKP1847540444P*
5	25.0	45.0	57.5	52.5	20.3	1.2	35	175	13.0	14.0	6	5.0	30	25	99	55	MKP1847550444Y*
6	30.0	45.0	57.5	52.5	20.3	1.2	35	210	15.0	16.0	6	5.0	30	25	131	45	MKP1847560444Y*
7	35.0	50.0	57.5	52.5	20.3	1.2	35	245	18.0	19.0	6	5.0	30	25	152	40	MKP1847570444Y*
8	35.0	50.0	57.5	52.5	20.3	1.2	35	280	19.0	20.0	6	5.0	30	25	146	40	MKP1847580444Y*
10	35.0	50.0	57.5	52.5	20.3	1.2	35	280	19.0	20.0	6	5.0	30	25	146	40	MKP1847610445Y*
12	45.0	45.0	57.5	52.5	20.3	1.2	35	350	22.0	23.0	6	5.0	30	25	186	30	MKP1847612445Y5

### Notes

- (1) Intermediate capacitance values are available on request
- (2) Standard dimension
- (3) Rated voltage pulse slope (dU/dt) R at voltage  $U_{NDC}$
- (4) Maximum RMS current at 10 kHz, + 85 °C, Capacitance tolerance specified
- (5) The ESR (Equivalent Series Resistance) can be calculated as  $\tan \delta (f)/(2 \times \pi \times f \times C)$
- (6) SPQ = Standard Packing Quantity
- (7) Change the \* symbols with special code for terminals



## CONSTRUCTION

Low inductive wound cell elements of metallized polypropylene film, potted with resin in a flame retardant case.

### Specific Method of Mounting to Withstand Vibration and Shock

The capacitor unit is designed for mounting on a printed circuit board.

In order to withstand vibration and shock tests, it must be insured that the stand-off pips are in good contact with the printed circuit board.

The capacitors shall be mechanically fixed by the leads and the body clamped.

### Space Requirements on Printed-Circuit Board

The maximum length and width of film capacitors is shown in the figure:

- Product height with seating plane as given by "IEC 60717" as reference:

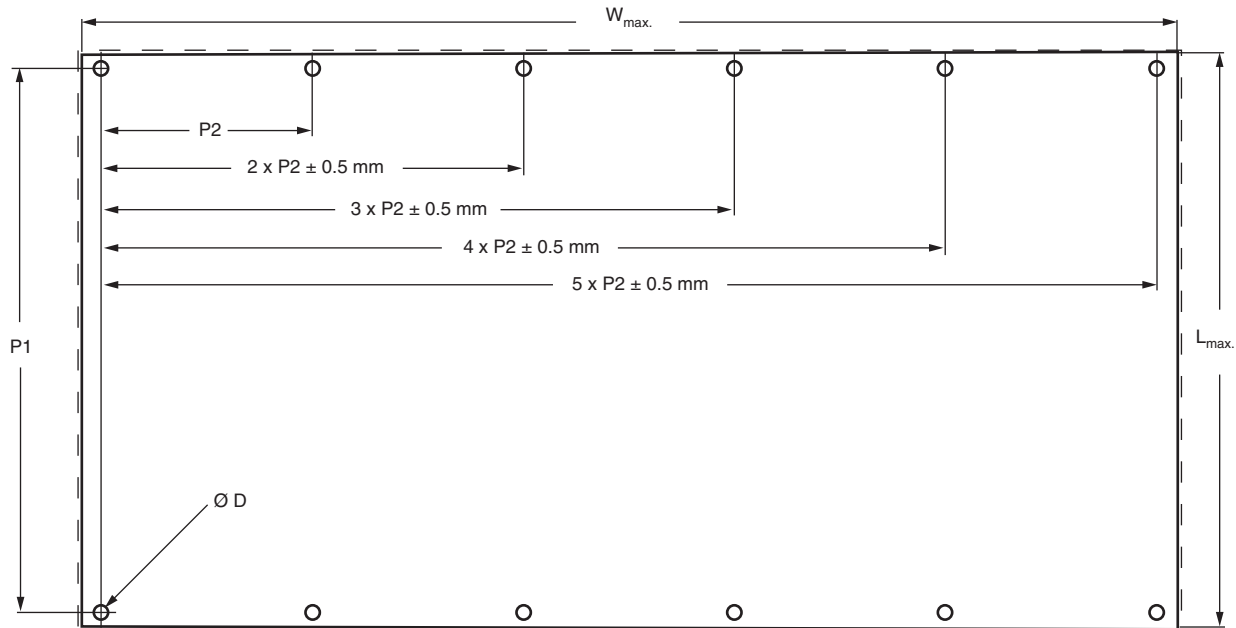

P1 (mm)	L <sub>max.</sub> (mm)	W <sub>max.</sub> (mm)	Ø D (mm)	Δh (mm)
27.5	l + 2	w + 1.6	1.2	0.2
37.5	l + 3	w + 2.0	1.5	0.5
52.5	l + 4	w + 2.4	1.7	0.5

## SOLDERING CONDITIONS

For general soldering conditions and wave soldering profile, we refer to the document:

"Characteristics and Definitions used for Film Capacitors": [www.vishay.com/doc?26033](http://www.vishay.com/doc?26033)

### Storage Temperature

- Storage temperature: T<sub>stg</sub> = - 25 °C to + 40 °C  
RH maximum 80 % without condensation.

### Ratings and Characteristics Reference Conditions

Unless otherwise specified, all electrical values apply to an ambient temperature of 23 °C ± 1 °C, an atmospheric pressure of 86 kPa to 106 kPa and a relative humidity of 50 % ± 2 %.

For reference testing, a conditioning period shall be applied over 96 h ± 4 h by heating the products in a circulating air oven at the rated temperature and a relative humidity not exceeding 20 %.

# MKP1847 AC Capacitors



Vishay Roederstein

Metallized Polypropylene Film Capacitor  
AC Capacitor MKP Type

## CHARACTERISTICS

Capacitance as a function of ambient temperature  
(typical curve)

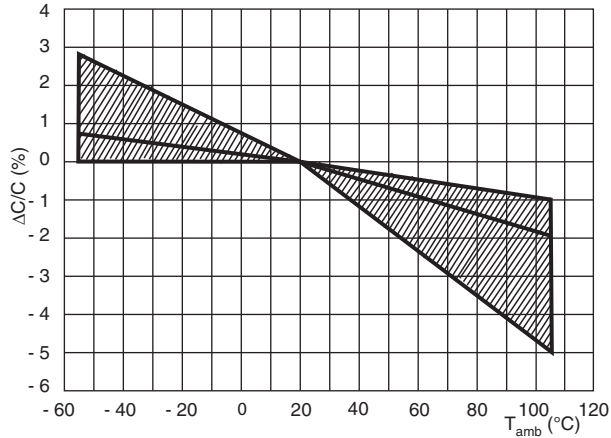

Insulation resistance as a function of ambient temperature  
(typical curve)

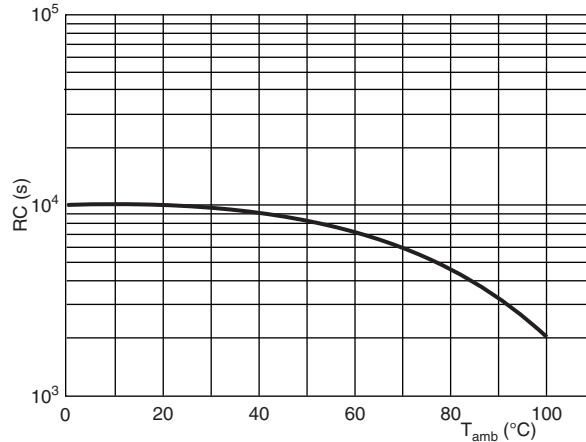

RMS voltage in function of temperature

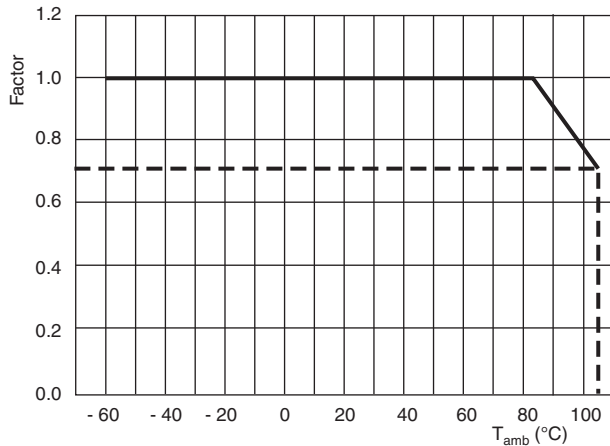

Impedance vs. frequency (typical curve)

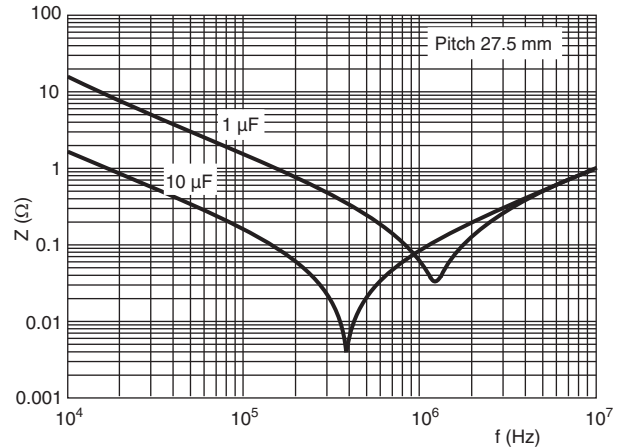

Impedance vs. frequency (typical curve)

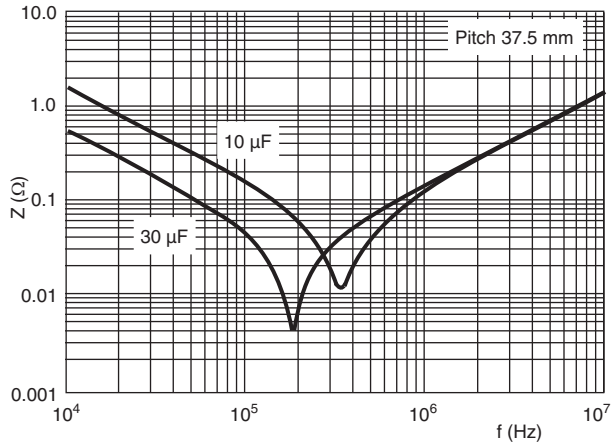

Impedance vs. frequency (typical curve)

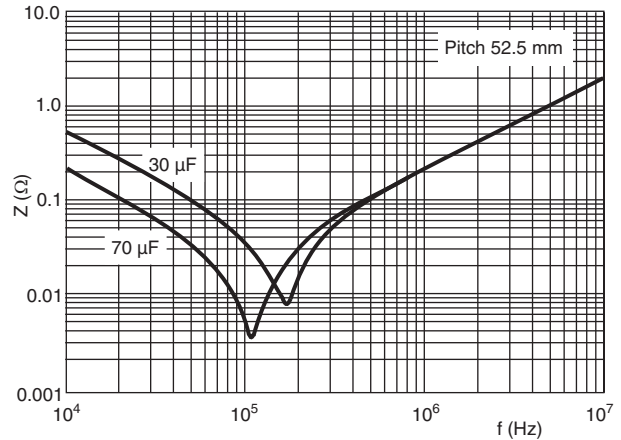

## HEAT CONDUCTIVITY

DIMENSIONS (mm)			HEAT CONDUCTIVITY (mW/°C)		
w (mm)	h (mm)	l (mm)	PITCH 27.5 mm	PITCH 37.5 mm	PITCH 52.5 mm
9.0	19.0	32.0	32	-	-
11.0	21.0	32.0	38	-	-
13.0	23.0	32.0	44	-	-
15.0	25.0	32.0	50	-	-
18.0	28.0	32.0	59	-	-
21.0	31.0	32.0	69	-	-
18.5	35.5	43.0	-	89	-
21.5	38.5	43.0	-	102	-
24.0	44.0	42.0	-	117	-
30.0	45.0	42.0	-	135	-
25.0	45.0	57.5	-	-	155
30.0	45.0	57.5	-	-	170
35.0	50.0	57.5	-	-	199
45.0	45.0	57.5	-	-	216

### Power Dissipation and Maximum Component Temperature Rise

The power dissipation must be limited in order not to exceed the maximum allowed component temperature rise as a function of the free air ambient temperature.

The component temperature rise ( $\Delta T$ ) can be measured or calculated by  $\Delta T = P/G$ :

- $\Delta T$  = component temperature rise (°C) with a maximum of 15 °C
- P = power dissipation of the component (mW)
- G = heat conductivity of the component (mW/°C)

### MEASURING THE COMPONENT TEMPERATURE

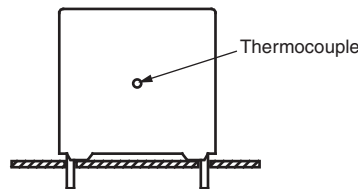

The case temperature is measured in unloaded ( $T_{amb}$ ) and maximum loaded condition ( $T_C$ ).

The temperature rise is given by  $\Delta T = T_C - T_{amb}$ .

To avoid thermal radiation or convection, the capacitor must be tested in a closed area from air circulation.

### APPLICATION NOTE AND LIMITING CONDITIONS

These capacitors are not suitable for mains applications as across-the-line capacitors without additional protection.

These mains applications are strictly regulated in safety standards and therefore electromagnetic interference suppression capacitors conforming the standards must be used.

To select the capacitor for a certain application, the following conditions must be checked:

- The peak voltage ( $U_{P+}$ ) shall not be greater than  $\sqrt{2} \times U_{RMS}$
- The peak-to-peak ripple voltage ( $U_{PP}$ ) shall not be greater than  $0.2 \times \sqrt{2} \times U_{RMS}$
- The voltage pulse slope ( $dU/dt$ ) shall not exceed the rated pulse slope at the DC voltage rating.

If the pulse voltage is lower than the rated DC voltage, the rated voltage pulse slope may be multiplied by  $U_{NDC}$  and divided by the applied voltage.

For all other pulses following equation must be fulfilled:

$$2 \times \int_0^T \left( \frac{dU}{dt} \right)^2 \times dt < U_{Ndc} \times \left( \frac{dU}{dt} \right)_{rated}$$

T is the pulse duration

- The maximum component surface temperature must be lower than 105 °C and maximum temperature rise between case and free air ambient shall be lower than 15 °C.

# MKP1847 AC Capacitors



Vishay Roederstein

Metallized Polypropylene Film Capacitor  
AC Capacitor MKP Type

## INSPECTION REQUIREMENTS

### General Notes

Sub-clause numbers of tests and performance requirements refer to the “Sectional Specification, Publication IEC 61071”.

SUB-CLAUSE NUMBER AND TEST	CONDITIONS	PERFORMANCE REQUIREMENTS
<b>ROUTINE TEST-FINAL INSPECTION</b>		
5.14.2.1 External inspection, visual examination		Legible marking as specified
5.14.2.2 Dimensions		See specification drawing
5.3.1 Capacitance	1 kHz at room temperature	See specific reference data
5.3.2 $\tan \delta$	1 kHz at room temperature 10 kHz at room temperature	See specific reference data
5.5.1.2 Voltage test between terminal	$1.5 \times U_{NDC}$ at $T_{amb}$ Duration 10 s	No visible damage or puncture No flashover
5.7 Insulation resistance	Measuring voltage 100 V at room temperature Duration 1 min	See specific reference data
<b>TYPE TESTS</b>		
5.14.2 External inspection	Check for finish, marking and overall dimensions	Legible marking and finish as specified Dimensions: see specific drawing
5.14.0 Initial measurements	Capacitance at 1 kHz $\tan \delta$ at 10 kHz	
5.14.1.1.4 Robustness of terminations IEC 60068-2-21	Tensile $U_a1$ Wire diameter section load $\leq 0.8$ mm $\leq 0.5$ mm <sup>2</sup> 10 N $\leq 1.25$ mm $\leq 1.2$ mm <sup>2</sup> 20 N Duration 10 s $\pm$ 1 s	
	Bending $U_b$ method 1 Wire diameter section load $\leq 0.8$ mm $\leq 0.05$ mm <sup>3</sup> 10 N $\leq 1.25$ mm $\leq 0.019$ mm <sup>3</sup> 20 N 4 x 90 °, Duration 2 s to 3 s/bend	
5.14.1.6 Resistance to soldering heat IEC 60068-2-20	No predrying, Method 1A Solder bath: 280 °C Duration 10 s $\pm$ 1 s	
5.14.4 Final measurements	Capacitance $\tan \delta$	$ \Delta C/C  \leq 0.5\%$ Increase of $\tan \delta \leq 0.0050$ Compared to values measured in 5.14.0
5.14.0 Initial measurements	Capacitance at 1 kHz $\tan \delta$ at 10 kHz	
5.14.3.1 Vibration IEC 60068-2-6	10 Hz to 55 Hz: amplitude $\pm 0.35$ mm or acceleration 98 m/s <sup>2</sup> Test duration: 10 frequency cycles, 3 axes offset from each other by 90° 1 octave/min Visual examination	No visible damage
5.14.3.2 Shock or impact IEC 60068-2-6	Pulse shape: half sine Acceleration: 490 m/s <sup>2</sup> Duration of pulse: 11 ms Visual examination	No visible damage
5.14.4 Final measurements	Capacitance $\tan \delta$	$ \Delta C/C  \leq 0.5\%$ Increase of $\tan \delta \leq 0.0050$ Compared to values measured in 5.14.0



# MKP1847 AC Capacitors

## Metallized Polypropylene Film Capacitor AC Capacitor MKP Type

Vishay Roederstein

SUB-CLAUSE NUMBER AND TEST	CONDITIONS	PERFORMANCE REQUIREMENTS
5.5.3.1 Initial measurements 5.5.3.2 DC voltage test between terminal 5.5.3.3 Final measurements	Capacitance at 1 kHz tan $\delta$ at 10 kHz R insulation 1.5 x U <sub>NDC</sub> at T <sub>amb</sub> Duration 60 s Capacitance tan $\delta$ R insulation	$ \Delta C/C  \leq 0.5\%$ Increase of tan $\delta \leq 0.0050$ R insulation $\geq 50\%$ of specified values
5.9.1 Initial measurements 5.9.2 Surge discharge test 5.9.3 DC voltage test between terminal 5.9.3 Final measurements	Capacitance at 1 kHz tan $\delta$ at 10 kHz 1.1 x U <sub>NDC</sub> Number of discharges: 5 Time lapse: every 2 min (10 min total) Within 5 min after the surge discharge test Duration 10 s 1.5 x U <sub>NDC</sub> at T <sub>amb</sub> Capacitance tan $\delta$ at 10 kHz	$ \Delta C/C  \leq 1.0\%$ tan $\delta \leq 1.2$ initial tan $\delta + 0.0001$ Compared to values measured in 5.9.1
5.11.1 Initial measurements 5.11.2 Self healing test 5.11.3 Final measurements	Capacitance at 1 kHz tan $\delta$ at 10 kHz 1.5 x U <sub>NDC</sub> Duration 10 s Number of clearings $\leq 5$ Clearing = voltage drop of 5 % increase the voltage at 100 V/s till 5 clearings occur with a max. of 2.5 x U <sub>NDC</sub> for a duration of 10 s Capacitance tan $\delta$	$ \Delta C/C  \leq 0.5\%$ tan $\delta \leq 1.2$ x initial tan $\delta + 0.0001$ Compared to values measured in 5.11.1
5.13.0 Initial measurements 5.13.1 Change of temperature acc. to IEC 60068-2-14 5.13.2 Damp heat steady state Acc. to IEC 60068-2-78 5.5.3.2 DC voltage test between terminal 5.13.3 Final measurements	Capacitance at 1 kHz tan $\delta$ at 10 kHz Test Nb T <sub>max.</sub> = 85 °C T <sub>min.</sub> = - 40 °C Transition time: 1 h, equivalent to 1 °C/min 5 cycles Test Ca T = 40 °C $\pm$ 2 °C RH = 93 % $\pm$ 3 % Duration 56 days 1.5 x U <sub>NDC</sub> at ambient temperature Duration 10 s Visual examination Capacitance tan $\delta$ at 10 kHz	No puncturing or flashover Self healing punctures are permitted $ \Delta C/C  \leq 2.0\%$ Increase of tan $\delta \leq 0.0150$ Compared to values measured in 5.13.0
5.10.0 Initial measurements 5.10.1 Thermal stability test under overload conditions 5.10.2 Final measurements	Capacitance at 1 kHz tan $\delta$ at 10 kHz Natural cooling T <sub>amb</sub> $\pm$ 5 °C 1.21 x P <sub>max.</sub> = (U <sub>2</sub> /2) x W <sub>2</sub> x C x tan $\delta$ = 121 x (I <sup>2</sup> <sub>max</sub> /W <sub>2</sub> x C) x tan $\delta_2$ with W <sub>2</sub> = 2 x $\pi$ x f <sub>2</sub> for I <sub>max.</sub> (see specific reference data) f <sub>2</sub> = 10 kHz Duration 48 h Measure the temperature every 1.5 h during the last 6 h Capacitance tan $\delta$ at 10 kHz	temperature rise < 1 °C $ \Delta C/C  \leq 2\%$ Increase of tan $\delta \leq 1.2$ x initial $\delta + 0.0150$





## Disclaimer

ALL PRODUCT, PRODUCT SPECIFICATIONS AND DATA ARE SUBJECT TO CHANGE WITHOUT NOTICE TO IMPROVE RELIABILITY, FUNCTION OR DESIGN OR OTHERWISE.

Vishay Intertechnology, Inc., its affiliates, agents, and employees, and all persons acting on its or their behalf (collectively, "Vishay"), disclaim any and all liability for any errors, inaccuracies or incompleteness contained in any datasheet or in any other disclosure relating to any product.

Vishay makes no warranty, representation or guarantee regarding the suitability of the products for any particular purpose or the continuing production of any product. To the maximum extent permitted by applicable law, Vishay disclaims (i) any and all liability arising out of the application or use of any product, (ii) any and all liability, including without limitation special, consequential or incidental damages, and (iii) any and all implied warranties, including warranties of fitness for particular purpose, non-infringement and merchantability.

Statements regarding the suitability of products for certain types of applications are based on Vishay's knowledge of typical requirements that are often placed on Vishay products in generic applications. Such statements are not binding statements about the suitability of products for a particular application. It is the customer's responsibility to validate that a particular product with the properties described in the product specification is suitable for use in a particular application. Parameters provided in datasheets and/or specifications may vary in different applications and performance may vary over time. All operating parameters, including typical parameters, must be validated for each customer application by the customer's technical experts. Product specifications do not expand or otherwise modify Vishay's terms and conditions of purchase, including but not limited to the warranty expressed therein.

Except as expressly indicated in writing, Vishay products are not designed for use in medical, life-saving, or life-sustaining applications or for any other application in which the failure of the Vishay product could result in personal injury or death. Customers using or selling Vishay products not expressly indicated for use in such applications do so at their own risk and agree to fully indemnify and hold Vishay and its distributors harmless from and against any and all claims, liabilities, expenses and damages arising or resulting in connection with such use or sale, including attorneys fees, even if such claim alleges that Vishay or its distributor was negligent regarding the design or manufacture of the part. Please contact authorized Vishay personnel to obtain written terms and conditions regarding products designed for such applications.

No license, express or implied, by estoppel or otherwise, to any intellectual property rights is granted by this document or by any conduct of Vishay. Product names and markings noted herein may be trademarks of their respective owners.