

Reference Only

Spec No. JELF243B-9102H-01

P.1/9

CHIP COIL (CHIP INDUCTORS) LQG18HH□□□□00D SPECIFICATION Murata Standard Reference Specification [AEC-Q200]

1. Scope

This reference specification applies to LQG18HH_00 series Chip coil (Chip inductors) for Automotive Electronics based on AEC-Q200.

2. Part Numbering

(ex) LQ G 18 H H 1N2 S 0 0 D
 Product ID Structure Dimension Applications Category Inductance Tolerance Features Electrode Packaging
 (L×W) and Characteristics for Automotive Electronics
 *B: BULK

*Bulk packing (B) also available

3. Rating

- Operating Temperature Range -55°C to +125°C
- Storage Temperature Range -55°C to +125°C

Customer Part Number	MURATA Part Number	Inductance (nH)	Tolerance	Q (min.)	DC Resistance (Ω max.)	Self Resonant Frequency (MHz min.)	Rated Current (mA)	ESD Rank 1C:1kV
		(*1) Refer to below comment						
	LQG18HH1N2S00D	1.2	±0.3nH	12	0.10	6000	1100	1C
	LQG18HH1N5S00D	1.5				5000		
	LQG18HH1N8S00D	1.8				4000		
	LQG18HH2N2S00D	2.2				3000		
	LQG18HH2N7S00D	2.7				2800		
	LQG18HH3N3S00D	3.3				2600		
	LQG18HH3N9S00D	3.9				2400		
	LQG18HH4N7S00D	4.7				2200		
	LQG18HH5N6S00D	5.6				1800		
	LQG18HH6N2S00D	6.2				1600		
	LQG18HH6N8J00D	6.8	±5%	14	0.17	1400	500	
	LQG18HH8N2J00D	8.2				1200		
	LQG18HH10NJ00D	10				1000		
	LQG18HH12NJ00D	12				900		
	LQG18HH15NJ00D	15				800		
	LQG18HH18NJ00D	18				700		
	LQG18HH22NJ00D	22				600		
	LQG18HH27NJ00D	27				550		
	LQG18HH33NJ00D	33				500		
	LQG18HH39NJ00D	39				450		
	LQG18HH47NJ00D	47	300	1.10	0.20	400		
	LQG18HH56NJ00D	56				800		
	LQG18HH68NJ00D	68				700		
	LQG18HH82NJ00D	82				600		
	LQG18HHR10J00D	100				550		
	LQG18HHR12J00D	120				500		
	LQG18HHR15J00D	150				450		
	LQG18HHR18J00D	180	400					
	LQG18HHR22J00D	220						
	LQG18HHR27J00D	270						

(*1) Testing Conditions

《Unless otherwise specified》

《In case of doubt》

Temperature : Ordinary Temperature / 15°C to 35°C

Temperature : 20°C ± 2°C

Humidity : Ordinary Humidity / 25% (RH) to 85% (RH)

Humidity : 60% (RH) to 70% (RH)

Atmospheric Pressure : 86kPa to 106 kPa

Reference Only

Spec No. JELF243B-9102H-01

P.2/9

4. Appearance and Dimensions

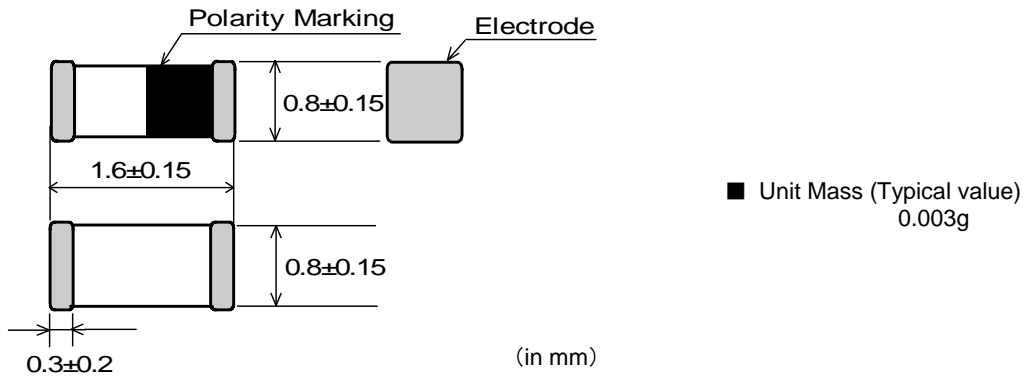

5. Electrical Performance

No.	Item	Specification	Test Method
5.1	Inductance	Inductance shall meet item 3.	Measuring Equipment: Keysight E4991A or equivalent Measuring Frequency: 100MHz Measuring Condition: Test signal level/ about 0dBm Electrode spaces / 1.0mm Electrical length/ 10mm Weight/ about 1N to 5N Measuring Fixture: Keysight 16197A Position coil under test as shown in below and contact coil with each terminal by adding weight. Polarity marking should be a topside, and polarity marking should be in the direction of the fixture for position of chip coil.
5.2	Q	Q shall meet item 3.	<p style="text-align: center;">Polarity Marking</p> Measuring Method: the endnote [Electrical Performance: Measuring Method of Inductance/ Q]
5.3	DC Resistance	DC Resistance shall meet item 3.	Measuring Equipment: Digital multi meter
5.4	Self Resonant Frequency (S.R.F)	S.R.F shall meet item 3.	Measuring Equipment: Keysight 8753C or equivalent
5.5	Rated Current	Self temperature rise shall be limited to 25°C max.	The rated current is applied.

Reference Only

Spec No. JELF243B-9102H-01

P.3/9

6. Q200 Requirement

6.1. Performance (based on Table 5 for Magnetics (Inductors / Transformer)

AEC-Q200 Rev.D issued June 1, 2010

AEC-Q200			Murata Specification / Deviation				
No	Stress	Test Method					
3	High Temperature Exposure	1000hours at 125 deg C Set for 24hours at room temperature, then measured.	Meet Table A after testing. Table A <table border="1" style="margin-left: auto; margin-right: auto;"> <tr> <td>Appearance</td> <td>No damage</td> </tr> <tr> <td>Inductance Change (at 100MHz)</td> <td>Within $\pm 10\%$</td> </tr> </table>	Appearance	No damage	Inductance Change (at 100MHz)	Within $\pm 10\%$
Appearance	No damage						
Inductance Change (at 100MHz)	Within $\pm 10\%$						
4	Temperature Cycling	1000cycles -40 deg C to +125 deg C Set for 24hours at room temperature, then measured.	Meet Table A after testing.				
7	Biased Humidity	1000hours at 85 deg C, 85%RH unpowered.	Meet Table A after testing.				
8	Operational Life	Apply 125 deg C 1000hours Set for 24hours at room temperature, then measured	Meet Table A after testing.				
9	External Visual	Visual inspection	No abnormalities				
10	Physical Dimension	Meet ITEM 4 (Style and Dimensions)	No defects				
12	Resistance to Solvents	Per MIL-STD-202 Method 215	Not Applicable				
13	Mechanical Shock	Per MIL-STD-202 Method 213 Condition C : 100g's(0.98N), 6ms, Half sine, 12.3ft/s	Meet Table A after testing.				
14	Vibration	5g's (0.049N) for 20 minutes, 12cycles each of 3 orientations Test from 10-2000Hz.	Meet Table A after testing.				
15	Resistance to Soldering Heat	No-heating Solder temperature 260C+/-5 deg C Immersion time 10s	Meet Table A after testing. Pre-heating 150C +/-10 deg C, 60s to 90s				
17	ESD	Per AEC-Q200-002	Meet Table A after testing. ESD Rank: refer to the Item3 (Rating).				
18	Solderbility	Per J-STD-002	Method b: Not Applicable 90% of the terminations is to be soldered.				
19	Electrical Characterization	Measured: Inductance	No defects				
20	Flammability	Per UL-94	Not Applicable				
21	Board Flex	Epoxy-PCB (1.6mm) Deflection 2mm (min) Holding time 60s	Meet Table B after testing. Table B <table border="1" style="margin-left: auto; margin-right: auto;"> <tr> <td>Appearance</td> <td>No damage</td> </tr> <tr> <td>DC Resistance Change</td> <td>Within $\pm 10\%$</td> </tr> </table>	Appearance	No damage	DC Resistance Change	Within $\pm 10\%$
Appearance	No damage						
DC Resistance Change	Within $\pm 10\%$						
22	Terminal Strength	Per AEC-Q200-006 A force of 17.7N for 60s	No defects				

Reference Only

Spec No. JELF243B-9102H-01

P.4/9

7. Specification of Packaging

7.1 Appearance and Dimensions of paper tape (8mm-wide)

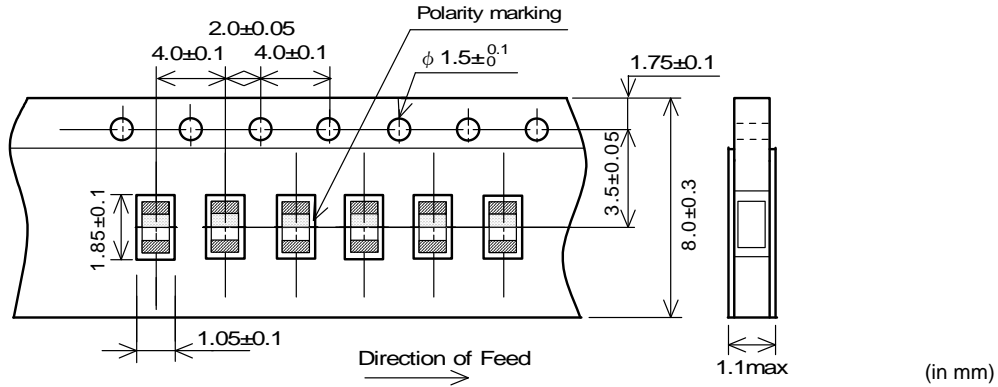

7.2 Specification of Taping

- (1) Packing quantity (standard quantity)
4,000 pcs. / reel
- (2) Packing Method
Products shall be packed in the cavity of the base tape and sealed by top tape and bottom tape.
- (3) Sprocket hole
The sprocket holes are to the right as the tape is pulled toward the user.
- (4) Spliced point
Base tape and Top tape has no spliced point.
- (5) Missing components number
Missing components number within 0.1 % of the number per reel or 1 pc., whichever is greater, and are not continuous. The Specified quantity per reel is kept.

7.3 Pull Strength

Top tape	5N min.
Bottom tape	

7.4 Peeling off force of cover tape

Speed of Peeling off	300mm/min
Peeling off force	0.1N to 0.6N (minimum value is typical)

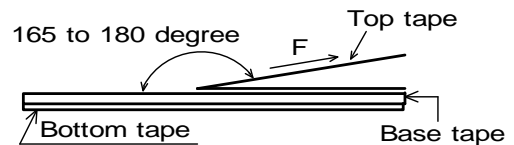

7.5 Dimensions of Leader-tape, Trailer and Reel

There shall be leader-tape (top tape and empty tape) and trailer-tape (empty tape) as follows.

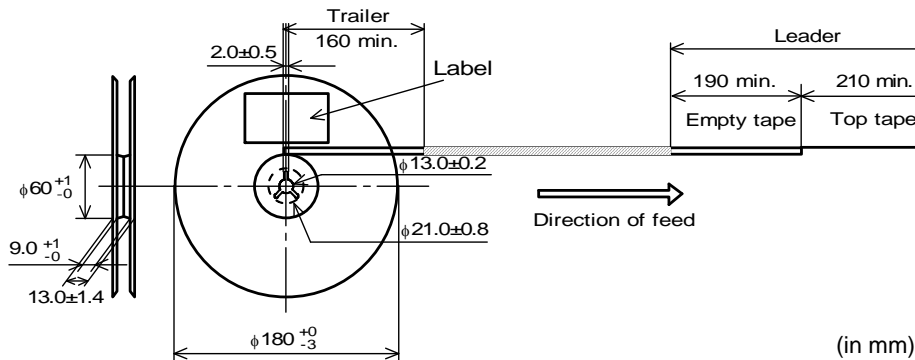

Reference Only

Spec No. JELF243B-9102H-01

P.5/9

7.6 Marking for reel

Customer part number, MURATA part number, Inspection number (*1), RoHS marking (*2), Quantity etc ...

*1) <Expression of Inspection No.>

$\square\square$ $\underline{0000}$ $\underline{\times\times\times}$
(1) (2) (3)

(1) Factory Code

(2) Date First digit : Year / Last digit of year

Second digit : Month / Jan. to Sep. → 1 to 9, Oct. to Dec. → O, N, D

Third, Fourth digit : Day

(3) Serial No.

*2) <Expression of RoHS marking>

ROHS - \underline{Y} ($\underline{\Delta}$)
(1) (2)

(1) RoHS regulation conformity parts.

(2) MURATA classification number

7.7 Marking for Outside package (corrugated paper box)

Customer name, Purchasing order number, Customer part number, MURATA part number, RoHS marking(*2), Quantity, etc ...

7.8. Specification of Outer Case

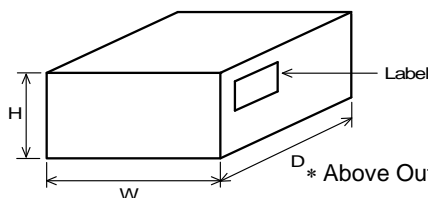

Outer Case Dimensions (mm)			Standard Reel Quantity in Outer Case (Reel)
W	D	H	
186	186	93	5

D* Above Outer Case size is typical. It depends on a quantity of an order.

8. Caution

8.1 Limitation of Applications

Please contact us before using our products for the applications listed below which require especially high reliability for the prevention of defects which might directly cause damage to the third party's life, body or property.

- | | |
|-----------------------------------|--|
| (1) Aircraft equipment | (6) Transportation equipment (trains, ships, etc.) |
| (2) Aerospace equipment | (7) Traffic signal equipment |
| (3) Undersea equipment | (8) Disaster prevention / crime prevention equipment |
| (4) Power plant control equipment | (9) Data-processing equipment |
| (5) Medical equipment | (10) Applications of similar complexity and /or reliability requirements to the applications listed in the above |

8.2 Caution (Rating)

Do not exceed maximum rated current of the product. Thermal stress may be transmitted to the product and short/open circuit of the product or falling off the product may be occurred.

8.3 Fail-safe

Be sure to provide an appropriate fail-safe function on your product to prevent a second damage that may be caused by the abnormal function or the failure of our product.

9. Notice

Products can only be soldered with reflow.

This product is designed for solder mounting.

Please consult us in advance for applying other mounting method such as conductive adhesive.

Please check the mounting condition before using.

Using mounting conditions (nozzles, equipment conditions, etc.) that are not suitable for products may lead to pick up errors, misalignment, or damage to the product.

Reference Only

9.1 Land pattern designing

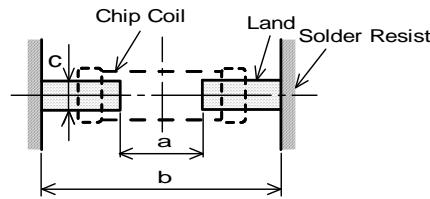

a	0.7
B	2.0
c	0.7

(in mm)

9.2 Flux, Solder

- Use rosin-based flux.
Don't use highly acidic flux with halide content exceeding 0.2(wt) % (chlorine conversion value).
Don't use water-soluble flux.
- Use Sn-3.0Ag-0.5Cu solder.
- Standard thickness of solder paste : 100 μm to 150 μm.

9.3 Reflow soldering conditions

- Inductance value may be changed a little due to the amount of solder.
So, the chip coil shall be soldered by reflow so that the solder volume can be controlled.
- Pre-heating should be in such a way that the temperature difference between solder and product surface is limited to 150°C max. Cooling into solvent after soldering also should be in such a way that the temperature difference is limited to 100°C max.
Insufficient pre-heating may cause cracks on the product, resulting in the deterioration of products quality.
- Standard soldering profile and the limit soldering profile is as follows.
The excessive limit soldering conditions may cause leaching of the electrode and / or resulting in the deterioration of product quality.

• Reflow soldering profile

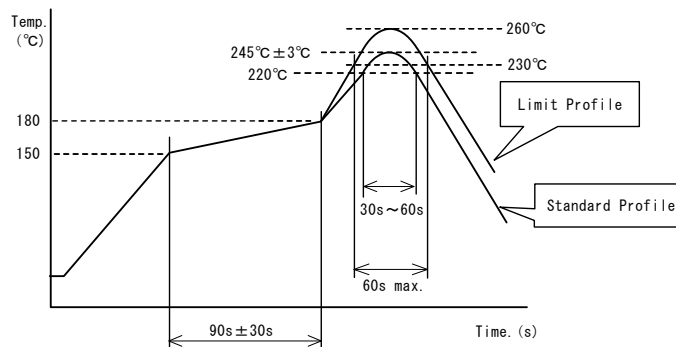

	Standard Profile	Limit Profile
Pre-heating	150°C~180°C, 90s±30s	
Heating	above 220°C, 30s~60s	above 230°C, 60s max.
Peak temperature	245°C±3°C	260°C, 10s
Cycle of reflow	2 times	

9.4 Reworking with soldering iron

The following conditions must be strictly followed when using a soldering iron.

Pre-heating	150°C, 1 min
Tip temperature	350°C max.
Soldering iron output	80W max.
Tip diameter	φ3mm max.
Soldering time	3(+1,-0)s
Time	2 times

Note : Do not directly touch the products with the tip of the soldering iron in order to prevent the crack on the products due to the thermal shock.

Reference Only

9.5 Solder Volume

- Solder shall be used not to be exceeded the upper limits as shown below.
- Accordingly increasing the solder volume, the mechanical stress to Chip is also increased. Exceeding solder volume may cause the failure of mechanical or electrical performance.

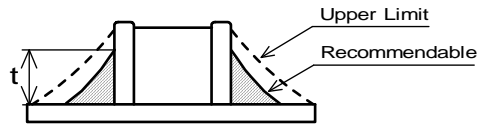

$$1/3T \leq t \leq T$$

T: thickness of product

9.6 Mount Shock

Over Mechanical stress to products at mounting process causes crack and electrical failure etc.

9.7 Product's location

The following shall be considered when designing and laying out P.C.B.'s.

- (1) P.C.B. shall be designed so that products are not subject to the mechanical stress due to warping the board.

[Products direction]

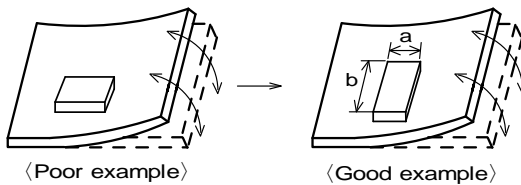

Products shall be located in the sideways direction (Length: $a < b$) to the mechanical stress.

- (2) Components location on P.C.B. separation.

It is effective to implement the following measures, to reduce stress in separating the board.

It is best to implement all of the following three measures; however, implement as many measures as possible to reduce stress.

Contents of Measures	Stress Level
(1) Turn the mounting direction of the component parallel to the board separation surface.	$A > D^{*1}$
(2) Add slits in the board separation part.	$A > B$
(3) Keep the mounting position of the component away from the board separation surface.	$A > C$

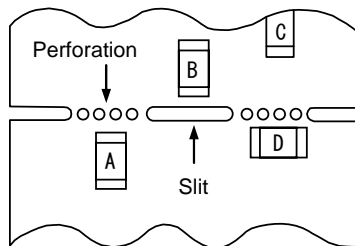

*1 $A > D$ is valid when stress is added vertically to the perforation as with Hand Separation. If a Cutting Disc is used, stress will be diagonal to the PCB, therefore $A > D$ is invalid.

- (3) Mounting Components Near Screw Holes

When a component is mounted near a screw hole, it may be affected by the board deflection that occurs during the tightening of the screw. Mount the component in a position as far away from the screw holes as possible.

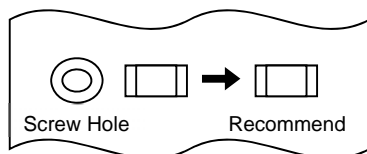

9.8 Cleaning Conditions

Products shall be cleaned on the following conditions.

- (1) Cleaning temperature shall be limited to 60°C max. (40°C max for IPA.)
- (2) Ultrasonic cleaning shall comply with the following conditions with avoiding the resonance phenomenon at the mounted products and P.C.B.
Power : 20 W / l max. Frequency : 28kHz to 40kHz Time : 5 min max.
- (3) Cleaner
 1. Alcohol type cleaner
Isopropyl alcohol (IPA)
 2. Aqueous agent
PINE ALPHA ST-100S
- (4) There shall be no residual flux and residual cleaner after cleaning. In the case of using aqueous agent, products shall be dried completely after rinse with de-ionized water in order to remove the cleaner.
- (5) Other cleaning Please contact us.

9.9 Resin coating

The inductance value may change and/or it may affect on the product's performance due to high cure-stress of resin to be used for coating / molding products. So please pay your careful attention when you select resin. In prior to use, please make the reliability evaluation with the product mounted in your application set.

9.10 Handling of a substrate

After mounting products on a substrate, do not apply any stress to the product caused by bending or twisting to the substrate when cropping the substrate, inserting and removing a connector from the substrate or tightening screw to the substrate.

Excessive mechanical stress may cause cracking in the product.

Bending

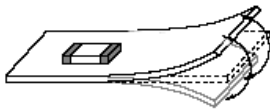

Twisting

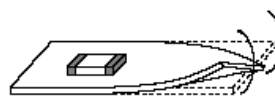

9.11 Storage and Handling Requirements

- (1) Storage period
Use the products within 6 months after delivered.
Solderability should be checked if this period is exceeded.
- (2) Storage conditions
 - Products should be stored in the warehouse on the following conditions.
Temperature : -10°C to 40°C
Humidity : 15% to 85% relative humidity No rapid change on temperature and humidity
Don't keep products in corrosive gases such as sulfur, chlorine gas or acid, or it may cause oxidization of electrode, resulting in poor solderability.
 - Products should be stored on the palette for the prevention of the influence from humidity, dust and so on.
 - Products should be stored in the warehouse without heat shock, vibration, direct sunlight and so on.
 - Products should be stored under the airtight packaged condition.
- (3) Handling Condition
Care should be taken when transporting or handling product to avoid excessive vibration or mechanical shock.

10. Notes

- (1) Please make sure that your product has been evaluated in view of your specifications with our product being mounted to your product.
- (2) You are requested not to use our product deviating from the reference specifications.
- (3) The contents of this reference specification are subject to change without advance notice.
Please approve our product specifications or transact the approval sheet for product specifications before ordering.

Reference Only

<Electrical Performance:Measuring Method of Inductance/Q>

(1) Residual elements and stray elements of test fixture can be described by F-parameter shown in following.

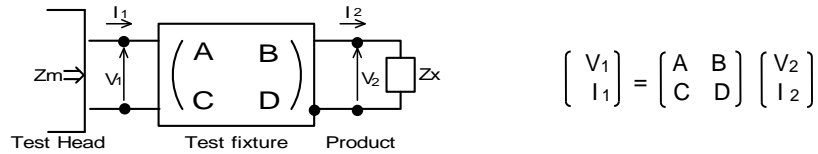

(2) The impedance of chip coil Z_x and measured value Z_m can be described by input/output current/voltage.

$$Z_m = \frac{V_1}{I_1}, \quad Z_x = \frac{V_2}{I_2}$$

(3) Thus, the relation between Z_x and Z_m is following;

$$Z_x = \alpha \frac{Z_m - \beta}{1 - Z_m \Gamma}$$

where, $\alpha = D / A = 1$
 $\beta = B / D = Z_{sm} - (1 - Y_{om}) Z_{ss}$
 $\Gamma = C / A = Y_{om}$

$\left[\begin{array}{l} Z_{sm}: \text{measured impedance of short chip} \\ Z_{ss}: \text{residual impedance of short chip (0nH)} \\ Y_{om}: \text{measured admittance when opening the fixture} \end{array} \right]$

(4) L_x and Q_x shall be calculated with the following equation.

$$L_x = \frac{\text{Im}(Z_x)}{2\pi f}, \quad Q_x = \frac{\text{Im}(Z_x)}{\text{Re}(Z_x)}$$

L_x : Inductance of chip coil
 Q_x : Q of chip coil
 f : Measuring frequency

Mouser Electronics

Authorized Distributor

Click to View Pricing, Inventory, Delivery & Lifecycle Information:

Murata:

[LQG18HH10NJ00D](#) [LQG18HH12NJ00D](#) [LQG18HH18NJ00D](#) [LQG18HH1N2S00D](#) [LQG18HH1N5S00D](#)
[LQG18HH1N8S00D](#) [LQG18HH22NJ00D](#) [LQG18HH27NJ00D](#) [LQG18HH2N2S00D](#) [LQG18HH2N7S00D](#)
[LQG18HH33NJ00D](#) [LQG18HH39NJ00D](#) [LQG18HH3N3S00D](#) [LQG18HH3N9S00D](#) [LQG18HH47NJ00D](#)
[LQG18HH4N7S00D](#) [LQG18HH56NJ00D](#) [LQG18HH5N6S00D](#) [LQG18HH68NJ00D](#) [LQG18HH6N2S00D](#)
[LQG18HH6N8J00D](#) [LQG18HH82NJ00D](#) [LQG18HH8N2J00D](#) [LQG18HHR10J00D](#) [LQG18HHR12J00D](#)
[LQG18HHR15J00D](#) [LQG18HHR18J00D](#) [LQG18HHR22J00D](#) [LQG18HHR27J00D](#) [LQG18HH47NJ00J](#)