

Description: 0.370" Right Angle / Machined

Dimensions (inch/mm)						
Pins	A	B	C	D	E	F
9	1.213	0.984	0.665	0.327	0.240	0.492
	30.80	25.00	16.90	8.30	6.10	12.50
15	1.543	1.311	0.994	0.327	0.240	0.492
	39.20	33.30	25.25	8.30	6.10	12.50
25	2.089	1.852	1.533	0.327	0.240	0.492
	53.05	47.05	38.95	8.30	6.10	12.50
37	2.732	2.500	2.181	0.327	0.240	0.492
	69.40	63.50	55.40	8.30	6.10	12.50
50	2.638	2.402	2.079	0.439	0.240	0.602
	67.00	61.00	52.80	11.15	6.10	15.30

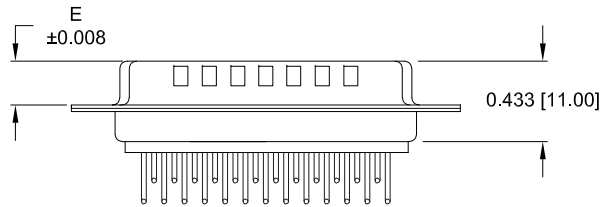
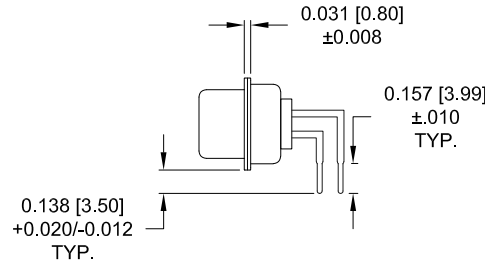
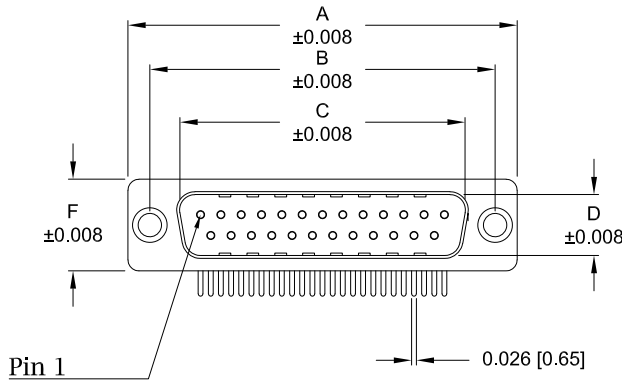

**Material:**

Shell: Nickel Plated Steel  
 Insulator: UL 94V-O Rated, White PA6T  
 Process Temperature: 260°C  
 Contact: Precision Machined Copper Alloy

**Electrical:**

Current Rating: 5 AMPS  
 Contact Resistance: 10 mOhms Max.  
 Insulation Resistance: 5 GOhms Min.  
 Working Voltage: 250V  
 Temperature: -55° C TO +125° C

174-EYY-11YRYY1

**Series**  
**Position**  
 E09  
 E15  
 E25  
 E37  
 E50  
**Gender**  
 1 = Male  
**Termination**  
 1 = PCB Mounting  
**Shell Plating**  
 3 = Nickel  
**RoHS Compliant**  
**Hardware Options**  
 00 = No Hardware  
 01 = 0,098" Clinch Nut (Board Side)  
 14 = Standard Bracket with 4-40 Screwlock  
 24 = Standard Bracket with 4-40 Captive Screw  
 46 = Boardlock Bracket with 4-40 Insert  
**Plating Options**  
 1 = Gold Flash  
 2 = 30μ" Gold  
 3 = 50μ" Gold

RoHS COMPLIANT

UNITS = inch [mm]

DO NOT SCALE FROM DRAWING



THESE DRAWINGS AND SPECIFICATIONS ARE THE PROPERTY OF NorComp AND SHALL NOT BE REPRODUCED, COPIED OR USED AS THE BASIS FOR THE MANUFACTURE OR SALE OF APPARATUS WITHOUT WRITTEN PERMISSION.

DRAWN:  
 PAM JENKINS  
 DATE:  
 11/28/2005

NorComp

SCALE: NTS	SHEET 1	OF 3	REV 17
DWG NO.		174-EYY-11YRYY1	

9 POSITION

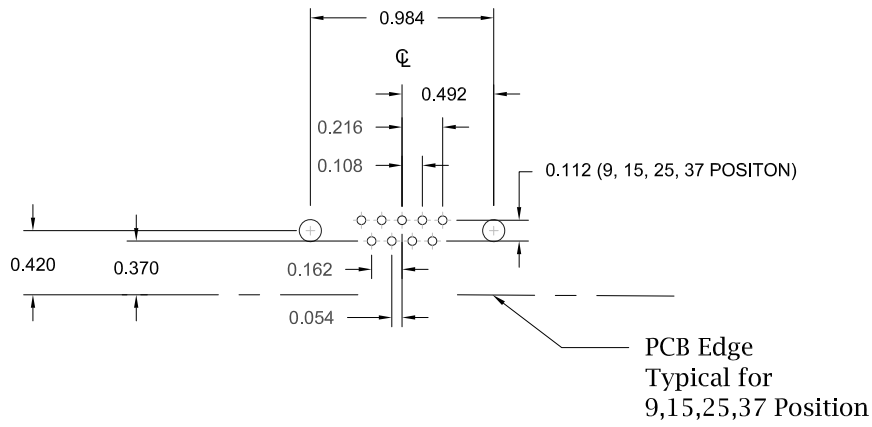

15 POSITION

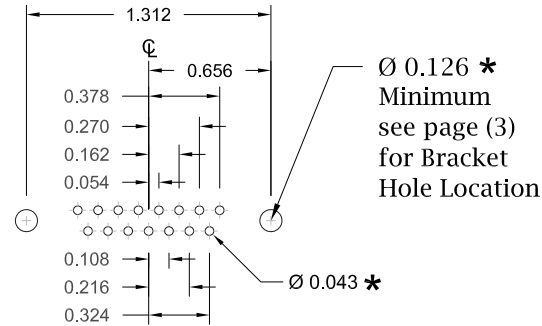

25 POSITION

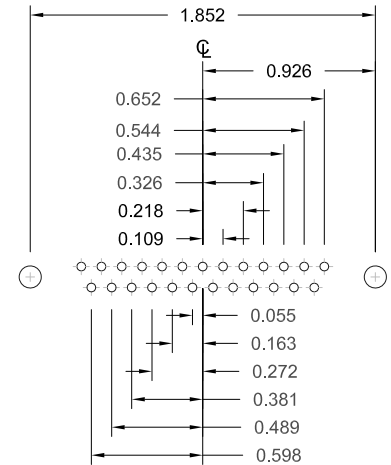

37 POSITION

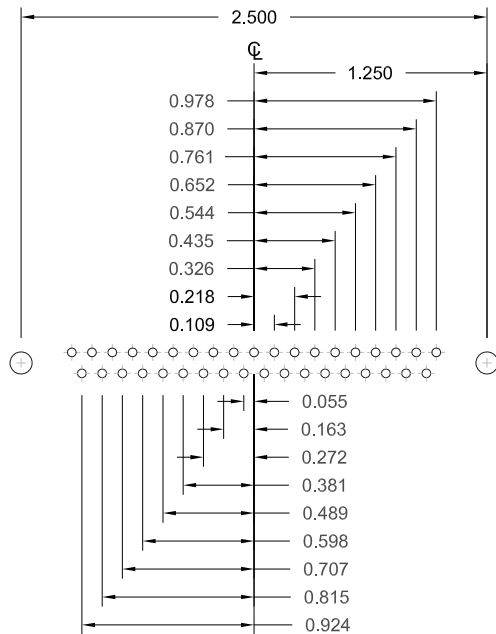

50 POSITION

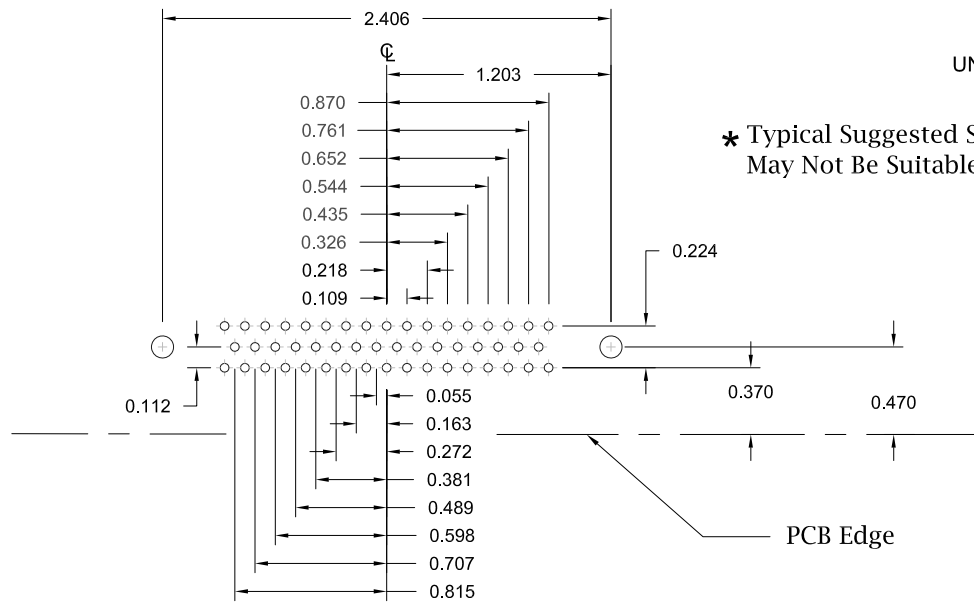

UNITS = inch

\* Typical Suggested Size  
May Not Be Suitable For All Applications

RoHS COMPLIANT

DO NOT SCALE FROM DRAWING



THESE DRAWINGS AND SPECIFICATIONS ARE THE PROPERTY OF NorComp AND SHALL NOT BE REPRODUCED, COPIED OR USED AS THE BASIS FOR THE MANUFACTURE OR SALE OF APPARATUS WITHOUT WRITTEN PERMISSION.

DRAWN:  
**PAM JENKINS**  
DATE:  
11/28/2005

**NorComp**

SCALE:  
NTS  
DWG NO.

SHEET OF  
2 3

REV  
17

174-EYY-11YRY1

**01 Hardware Option**  
0.098" Clinch Nut (Board Side)

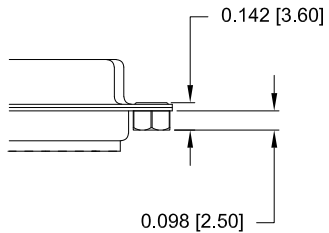

Clinch Nut has 4-40 Internal Threads

14 Hardware Option		
	Description	NorComp Part Number
1	4-40 Screwlock	SFSO4401NR
2	Bracket	K501CZ
3	Lock Washer	LW1-T
4	4-40 Nut	N4401N

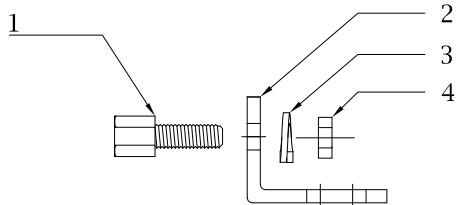

\*\*Search Hardware Part Number To Obtain Technical Specifications.

24 Hardware Option		
	Description	NorComp Part Number
1	4-40 Captive Screw	SSH4401T
2	Bracket	K501CZ
3	Lock Washer	LW1-T
4	4-40 Nut	N4401N

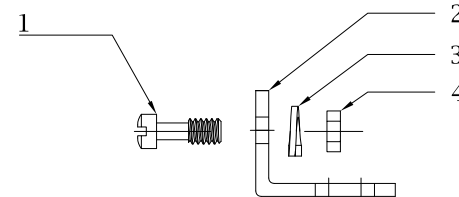

\*\*Search Hardware Part Number To Obtain Technical Specifications.

**46 Hardware Option**  
Boardlock Bracket and 4-40 Insert

#4-40 Threaded Insert

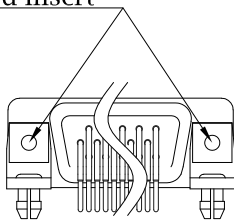

9-37 Position Connector Boardlock Bracket

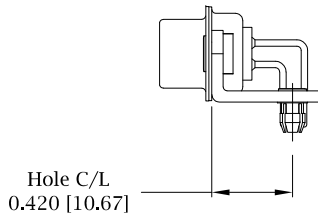

50 Position Connector Boardlock Bracket  
\*\* 50 Position Comes With Locator Plate

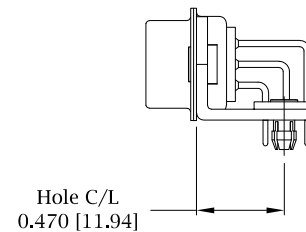

Boardlock Brackets Come Assembled On Connector

RoHS COMPLIANT

UNITS = inch [mm]

DO NOT SCALE FROM DRAWING



THESE DRAWINGS AND SPECIFICATIONS ARE THE PROPERTY OF NorComp AND SHALL NOT BE REPRODUCED, COPIED OR USED AS THE BASIS FOR THE MANUFACTURE OR SALE OF APPARATUS WITHOUT WRITTEN PERMISSION.

DRAWN:  
**PAM JENKINS**  
DATE:  
11/28/2005

**NorComp**

SCALE: NTS	SHEET 3	OF 3	REV 17
DWG NO.		174-EYY-11YRY1	

# Mouser Electronics

Authorized Distributor

Click to View Pricing, Inventory, Delivery & Lifecycle Information:

## NorComp:

[174-E09-113R001](#) [174-E15-113R001](#) [174-E25-113R001](#) [174-E37-113R001](#) [174-E50-113R001](#) [174-E25-113R141](#)  
[174-E09-113R141](#) [174-E37-113R141](#) [174-E15-113R141](#) [174-E50-113R141](#) [174-E50-113R241](#) [174-E09-113R461](#)  
[174-E15-113R461](#) [174-E25-113R461](#) [174-E37-113R461](#) [174-E50-113R461](#)