

## High Surge Axial Cemented Leaded Wirewound Resistors

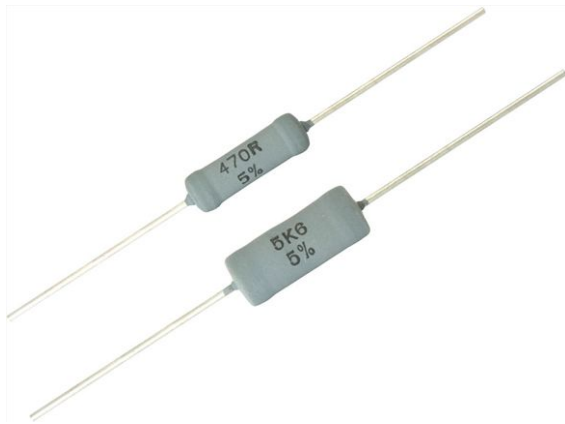

### FEATURES

- High voltage surge (up to 12 kV) withstanding capability
- Non flammable silicon cement coating
- High grade ceramic core
- Material categorization: for definitions of compliance please see [www.vishay.com/doc?99912](http://www.vishay.com/doc?99912)



**RoHS**  
COMPLIANT  
HALOGEN  
**FREE**  
**GREEN**  
(5-2008)

### APPLICATIONS

- Energy meter
- Appliances
- Ballast

### DESIGN SUPPORT TOOLS AVAILABLE



The Z300-Cxx series, is the perfect choice for high voltage surge applications. This product series is tested and proven to meet the 1.2 / 50  $\mu$ s pulse up to 12 kV defined in IEC 61000-4-5. Typical applications include but are not limited to energy meters, power supplies, etc.

STANDARD ELECTRICAL SPECIFICATIONS					
TYPE	POWER RATING $P_{40}$	POWER RATING $P_{70}$	RESISTANCE RANGE	RESISTANCE TOLERANCE <sup>(1)</sup>	TEMPERATURE COEFFICIENT <sup>(2)</sup>
Z301-Cxx	1 W	0.9 W	430 $\Omega$ to 2 k $\Omega$	± 5 %, ± 10 %	± 200 ppm/K
ZDA0411-Cxx	2 W	1.8 W	180 $\Omega$ to 4.3 k $\Omega$		
Z302-Cxx	3 W	2.7 W	62 $\Omega$ to 3.3 k $\Omega$		
Z303-Cxx	4 W	3.5 W	27 $\Omega$ to 3.9 k $\Omega$		
Z304-Cxx	5 W	4.4 W	15 $\Omega$ to 5.6 k $\Omega$		
Z305-Cxx	6 W	5.3 W	4.7 $\Omega$ to 10 k $\Omega$		

#### Notes

- <sup>(1)</sup> Resistance value to be selected for ± 10 % tolerance from E12 and for ± 5 % from E24, 1 % tolerance available on request  
<sup>(2)</sup> Lower TCR products are available on request



PART NUMBER AND PRODUCT DESCRIPTION																	
Part Number: Z34081834700J6DC10																	
Z	3	4	0	8	1	8	3	4	7	0	0	J	6	D	C	1	0
TYPE		TCR/MATERIAL		RESISTANCE			TOLERANCE CODE		PACKAGING CODE		SPECIAL (1)						
Z310309 = Z301-C ZDA0411 = ZDA0411-C Z320414 = Z302-C Z330617 = Z303-C Z340818 = Z304-C Z350922 = Z305-C		1 = ± 100 ppm/K 3 = ± 200 ppm/K 4 = SWI (special winding)		3 digit value 1 digit multiplier MULTIPLIER 7 = *10 <sup>-3</sup> 8 = *10 <sup>-2</sup> 9 = *10 <sup>-1</sup> 0 = *10 <sup>0</sup> 1 = *10 <sup>1</sup> 2 = *10 <sup>2</sup>			J = ± 5.0 % K = ± 10.0 %		(see Packaging table)		C04 = 4 kV surge C06 = 6 kV surge C08 = 8 kV surge C10 = 10 kV surge C12 = 12 kV surge						
Product Description: Z304-C 3 470R 5 % AB G63 CD1278																	
Z304-C		3		470R		5 %		AB G63		CD1278							
TYPE		TCR/MATERIAL		RESISTANCE		TOLERANCE CODE		PACKAGING DESCRIPTION		CDxxxx = speciality							
Z301-C ZDA0411-C Z302-C Z303-C Z304-C Z305-C				15R 5K6		5 % 10 %		A1 G53 AC G53 AC G73 AC G83 AB G63 AB G83									

**MINIMUM RESISTANCE VALUE FOR HANDLING SURGE VOLTAGE AS PER IEC 61000-4-5 (1.2 / 50 µs PULSE)**

POWER	TYPE	4 kV SURGE	6 kV SURGE	8 kV SURGE	10 kV SURGE	12 kV SURGE
1 W	Z301-Cxx	430R	1K5	-	-	-
2 W	ZDA0411-Cxx	180R	510R	1K1	2K2	3K3
3 W	Z302-Cxx	62R	330R	680R	1K8	2K2
4 W	Z303-Cxx	27R	91R	220R	470R	820R
5 W	Z304-Cxx	15R	43R	82R	100R	330R
6 W	Z305-Cxx	4.7R	18R	27R	68R	130R

Example: for a Z304-C10, 5 W resistor to withstand 10 kV surge, minimum ohmic value should be 100 Ω. So the part number will be Z34081831000J6DC10

**Note**

(1) As surge handling capacity depends upon resistor model and ohmic value, please check feasibility of resistor model, ohmic value and desired surge handling voltage with factory ([ww1resistors@vishay.com](mailto:ww1resistors@vishay.com))

**PACKAGING**

TYPE	CODE	DESCRIPTION	QUANTITY	PACKAGING STYLE	WIDTH	PITCH	DIMENSIONS
Z301-Cxx	21	A1 G53	1000	Taped acc. to IEC 60286-1 fan-folded in a box	53 mm	5 mm	84 mm x 73 mm x 326 mm
ZDA0411-Cxx	21	A1 G53	1000				84 mm x 73 mm x 326 mm
Z302-Cxx	2C	AC G53	500		53 mm	5 mm	82 mm x 29 mm x 324 mm
	4C	AC G73	500				110 mm x 76 mm x 334 mm
	6C	AC G83	500				110 mm x 87 mm x 324 mm
Z303-Cxx	2C	AC G53	500		53 mm	5 mm	82 mm x 49 mm x 324 mm
	6C	AC G83	500				110 mm x 87 mm x 324 mm
Z304-Cxx	6D	AB G63	250		63 mm	10 mm	84 mm x 73 mm x 326 mm
	6E	AB G83	250				84 mm x 73 mm x 326 mm
	6B	AB G83	250				83 mm



## DESCRIPTION

Wirewound resistors are best suited for use in high power, high current applications. The silicon cement lacquer coating enables Z300-Cxx to withstand challenging high voltage surge conditions.

Suitable ohmic value with desired surge voltage handling can be selected using table "Minimum Resistance Value for Handling Surge Voltage as per IEC 61000-4-5 (1.2 / 50  $\mu$ s Pulse)" on page 2. The ceramic meets the highest requirements against mechanical resistance, thermal shocks, dielectric strength, and insulation resistance at high temperatures. With different diameters and turn spacing's, a large ohmic value range can be covered. The coating is resistant to cleaning solvents specified in IEC 60115-1 (1). The resistors are marked with resistance and tolerance.

Product quality is verified by testing procedures, performed on all individual resistors. Resistance is measured on the lead wires at a distance of 6 mm from the resistor body. If a greater length of lead wire is used in the application, the user may need to consider the additional wire resistance, particularly with low resistance products.

## MATERIALS

Vishay acknowledges the following systems for the regulation of hazardous substances:

- IEC 62474, Material Declaration for Products of and for the Electrotechnical Industry, with the list of declarable substances given therein (2)
- The Global Automotive Declarable Substance List (GADSL) (3)
- The REACH regulation (1907/2006/EC) and the related list of substances with very high concern (SVHC) (4) for its supply chain

The products do not contain any of the banned substances as per IEC 62474, GADSL, or the SVHC list, see [www.vishay.com/how/leadfree](http://www.vishay.com/how/leadfree). Hence the products fully comply with the following directives:

- 2000/53/EC End-of-Life Vehicle Directive (ELV) and Annex II (ELV II)
- 2011/65/EU Restriction of the Use of Hazardous Substances Directive (RoHS) with amendment 2015/863/EU
- 2012/19/EU Waste Electrical and Electronic Equipment Directive (WEEE)

Vishay pursues the elimination of conflict minerals from its supply chain, see the Conflict Minerals Policy at [www.vishay.com/doc?49037](http://www.vishay.com/doc?49037).

## Notes

- (1) Other cleaning solvents with aggressive chemicals should be evaluated in actual cleaning process for their suitability
- (2) The IEC 62474 list of declarable substances is maintained in a dedicated database, which is available at <http://std.iec.ch/iec62474>
- (3) The Global Automotive Declarable Substance List (GADSL) is maintained by the American Chemistry Council and available at [www.gadsl.org](http://www.gadsl.org)
- (4) The SVHC list is maintained by the European Chemical Agency (ECHA) and available at <http://echa.europa.eu/candidate-list-table>

## ASSEMBLY

The resistors are axial leaded for soldering. The terminals of the resistors are completely lead (Pb)-free, the special tin plating provides compatibility with lead (Pb)-free and lead-containing soldering processes.

Special lead forms may be available on request, please inquire at [ww1resistors@vishay.com](mailto:ww1resistors@vishay.com).

These components are high dissipation power resistors, customers are advised to use a high melting point solder.

## APPLICATION INFORMATION

The power dissipation of the resistor generates a temperature rise with respect to the ambient. The permissible dissipation is derated for temperatures above 40 °C, as shown in the derating diagram, in order to avoid overheating of the resistor. The heat dissipated from the resistor may affect adjacent components, hence proper clearance will be required in order to avoid overheating. The resistive wire is hermetically encapsulated.

All materials used are non-flammable and inorganic. These resistors do not feature a limited lifetime when operated within the permissible limits. However, resistance value drift increasing over operating time may result in exceeding a limit acceptable to the specific application, thereby establishing a functional lifetime.

## RELATED PRODUCTS

In similar continuous power applications and challenging environmental conditions, see the datasheets:

- AC Series - Cemented Wirewound Resistors  
[www.vishay.com/doc?28730](http://www.vishay.com/doc?28730)
- Z300-C00 - Commercial Axial Cemented Wirewound Resistors  
[www.vishay.com/doc?21047](http://www.vishay.com/doc?21047)

For precision applications, there is the cement coated PAC series, see the datasheet:

- PAC Series - Cemented Wirewound Precision Resistors  
[www.vishay.com/doc?28731](http://www.vishay.com/doc?28731)

**FUNCTIONAL PERFORMANCE**

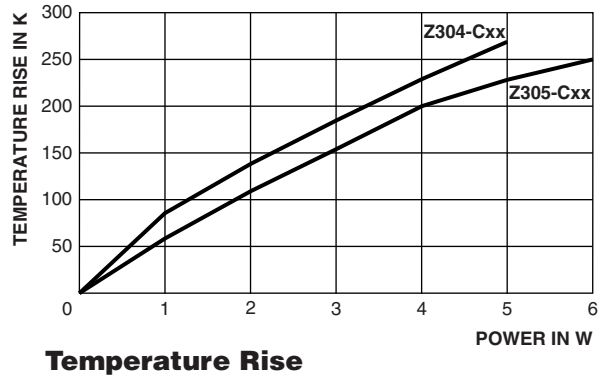
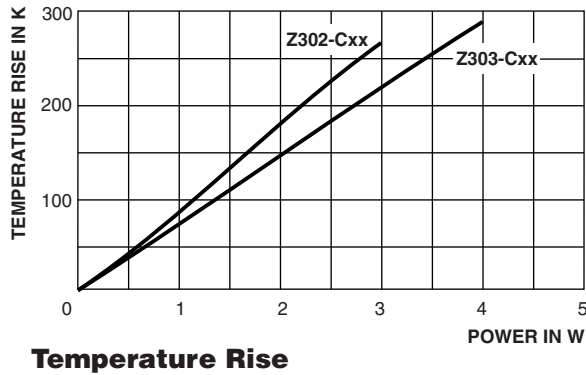
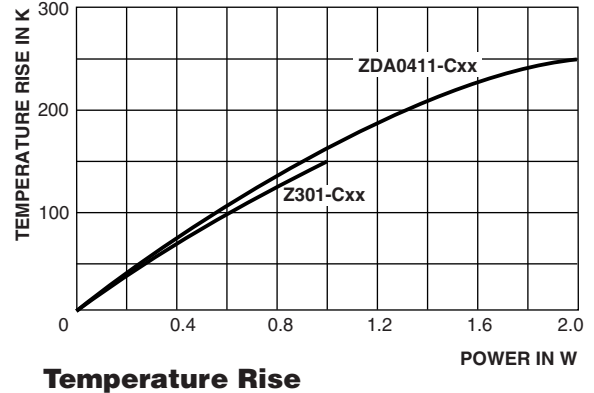
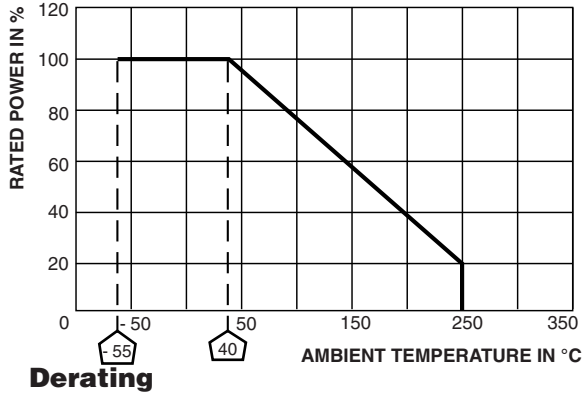

**HIGH VOLTAGE SURGE**

The specially designed Z300-Cxx high surge wirewound resistors are tested for surge handling capability by applying surge voltage as per the 1.2 / 50 μs exponential open circuit voltage waveform according to IEC 61000-4-5 standard as shown below:

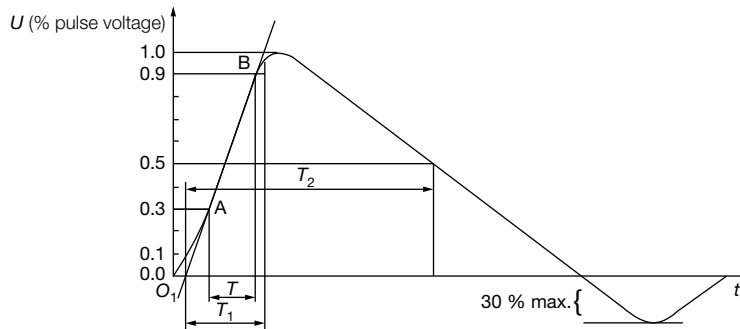

Front time:  $T_1 = 1.67 \times T = 1.2 \mu s \pm 30 \%$   
 Time to half-value:  $T_2 = 50 \mu s \pm 20 \%$

**Waveform of open-circuit voltage (1.2 / 50 μs) at the output of pulse generator**



TESTS PROCEDURES AND REQUIREMENTS

All tests are carried out in accordance with the following specifications:

- IEC 60115-1, generic specification (includes tests)

The test and requirements table contains only the most important tests. For the full test schedule refer to the documents listed above.

The tests are carried out with reference to IEC 60115-1, in accordance with IEC 60068-2-xx test method and under standard atmospheric conditions in accordance with IEC 60068-1, 5.3.

A climatic category 40 / 200 / 56 is applied, defined by the lower category temperature (LCT = -40 °C), the upper category temperature (UCT = 200 °C), and the duration of exposure in the damp heat, steady state test (56 days).

Unless otherwise specified the following values apply:

- Temperature: 15 °C to 35 °C
- Relative humidity: 45 % to 75 %
- Air pressure: 86 kPa to 106 kPa (860 mbar to 1060 mbar).

For performing some of the tests, the components are mounted on a test board in accordance with IEC 60115-1, 4.31.

In test procedures and requirements table, only the tests and requirements are listed with reference to the relevant clauses of IEC 60115-1 and IEC 60068-2-xx test methods. A short description of the test procedure is also given.

Table with 5 columns: IEC 60115-1 CLAUSE, IEC 60068-2 TEST METHOD, TEST, PROCEDURE, and REQUIREMENTS PERMISSIBLE CHANGE (ΔRMAX). Rows include tests like Short time overload, Robustness of terminations, Resistance to soldering heat, Climatic sequence (dry heat, damp heat, cold, low air pressure, damp heat remaining cyclic), Damp heat (steady state), Endurance (at room temperature and 200 °C), and Surge test.

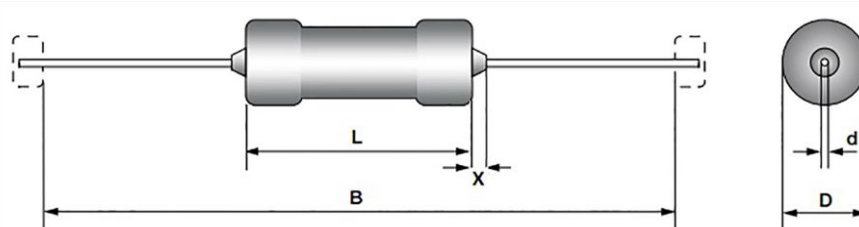
**DIMENSIONS**

TYPE	DIMENSIONS in millimeters (inches)					
	L <sub>MAX.</sub>	D <sub>MAX.</sub>	d <sub>MAX.</sub>	B	X <sub>MAX.</sub>	MASS (g)
Z301-Cxx	8.5 (0.355)	3 (0.118)	0.7 (0.027)	53 ± 1 (2.087 ± 0.039)	2 (0.079)	0.5
ZDA0411-Cxx	11 (0.433)	4 (0.157)	0.7 (0.027)	53 ± 1 (2.087 ± 0.039)	2 (0.079)	0.8
Z302-Cxx	13 (0.512)	4.8 (0.189)	0.8 (0.031)	53 ± 1 (2.087 ± 0.039) 73 ± 1 (2.87 ± 0.039) 83 ± 1 (3.268 ± 0.039)	2 (0.079)	0.6 0.7 0.8
Z303-Cxx	15.8 (0.622)	5.5 (0.217)	0.8 (0.031)	63 ± 1 (2.48 ± 0.039) 83 ± 1 (3.268 ± 0.039)	2 (0.079)	1.0 1.1
Z304-Cxx	18 (0.709)	7.5 (0.295)	0.8 (0.031)	63 ± 1 (2.48 ± 0.039) 83 ± 1 (3.268 ± 0.039)	2 (0.079)	1.8 2.0
Z305-Cxx	22.3 (0.878)	8.7 (0.343)	0.8 (0.031)	83 ± 1 (3.268 ± 0.039)	2 (0.079)	3.8

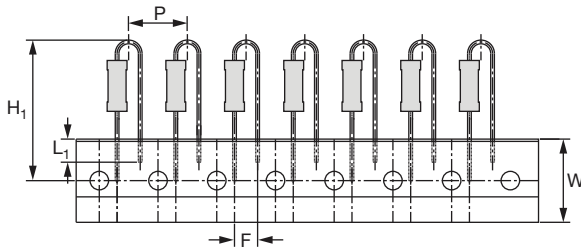
**ZDA0411-C RADIAL**

**DIMENSIONS in millimeters**

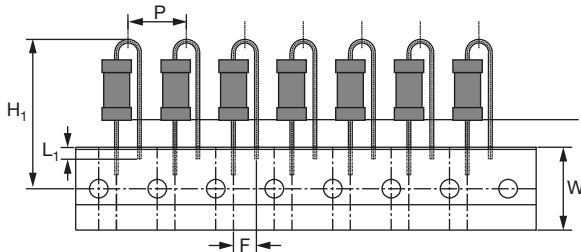
Pitch of components	P	12.7 ± 1.0
Lead to lead distance	F	4.8 + 0.7 / - 0
Tape width	W	18 ± 0.5
Component height	H <sub>1</sub>	30.0 ± 3
Min. lead wire (tape portion) shortest lead	L <sub>1</sub>	4.3

**Z302-C RADIAL**

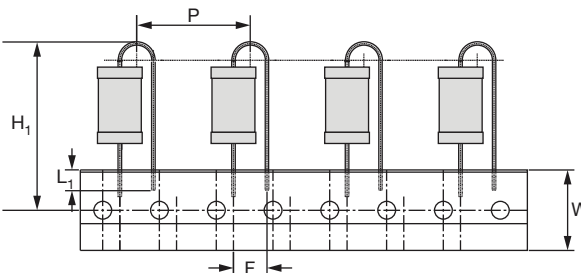
**DIMENSIONS in millimeters**

Pitch of components	P	12.7 ± 1.0
Lead to lead distance	F	5.00 ± 0.5
Tape width	W	18 ± 0.5
Maximum component height	H <sub>1</sub>	34
Min. lead wire (tape portion) shortest lead	L <sub>1</sub>	2.5

**Z304-C RADIAL**

**DIMENSIONS in millimeters**

Pitch of components	P	25.4 ± 1.0
Lead to lead distance	F	7.50 ± 0.5
Tape width	W	18 ± 0.5
Component height	H <sub>1</sub>	37 ± 2
Min. lead wire (tape portion) shortest lead	L <sub>1</sub>	4.3



## **Disclaimer**

ALL PRODUCT, PRODUCT SPECIFICATIONS AND DATA ARE SUBJECT TO CHANGE WITHOUT NOTICE TO IMPROVE RELIABILITY, FUNCTION OR DESIGN OR OTHERWISE.

Vishay Intertechnology, Inc., its affiliates, agents, and employees, and all persons acting on its or their behalf (collectively, "Vishay"), disclaim any and all liability for any errors, inaccuracies or incompleteness contained in any datasheet or in any other disclosure relating to any product.

Vishay makes no warranty, representation or guarantee regarding the suitability of the products for any particular purpose or the continuing production of any product. To the maximum extent permitted by applicable law, Vishay disclaims (i) any and all liability arising out of the application or use of any product, (ii) any and all liability, including without limitation special, consequential or incidental damages, and (iii) any and all implied warranties, including warranties of fitness for particular purpose, non-infringement and merchantability.

Statements regarding the suitability of products for certain types of applications are based on Vishay's knowledge of typical requirements that are often placed on Vishay products in generic applications. Such statements are not binding statements about the suitability of products for a particular application. It is the customer's responsibility to validate that a particular product with the properties described in the product specification is suitable for use in a particular application. Parameters provided in datasheets and / or specifications may vary in different applications and performance may vary over time. All operating parameters, including typical parameters, must be validated for each customer application by the customer's technical experts. Product specifications do not expand or otherwise modify Vishay's terms and conditions of purchase, including but not limited to the warranty expressed therein.

Except as expressly indicated in writing, Vishay products are not designed for use in medical, life-saving, or life-sustaining applications or for any other application in which the failure of the Vishay product could result in personal injury or death. Customers using or selling Vishay products not expressly indicated for use in such applications do so at their own risk. Please contact authorized Vishay personnel to obtain written terms and conditions regarding products designed for such applications.

No license, express or implied, by estoppel or otherwise, to any intellectual property rights is granted by this document or by any conduct of Vishay. Product names and markings noted herein may be trademarks of their respective owners.

# Mouser Electronics

Authorized Distributor

Click to View Pricing, Inventory, Delivery & Lifecycle Information:

[Vishay:](#)

[Z35092232209J6BC06](#) [Z33061731000J2CC06](#) [Z34081831000J6DC10](#) [Z32041436809J2CC04](#)  
[Z35092236809J6BC10](#) [Z35092231000J6BC10](#) [Z34081833300J6DC12](#) [Z35092232000J6BC12](#)  
[Z35092231509J6BC04](#) [Z32041433300J2CC06](#) [Z34081832209J6DC04](#)