

## Features

- 75 Ohm
- SMT unit
- RoHS Compliant and Pb free

## Description

MAFL-011057 is a Low Cost, surface mount Diplex Filter unit designed for CATV applications, DTV and DBS applications.

## Functional Schematic

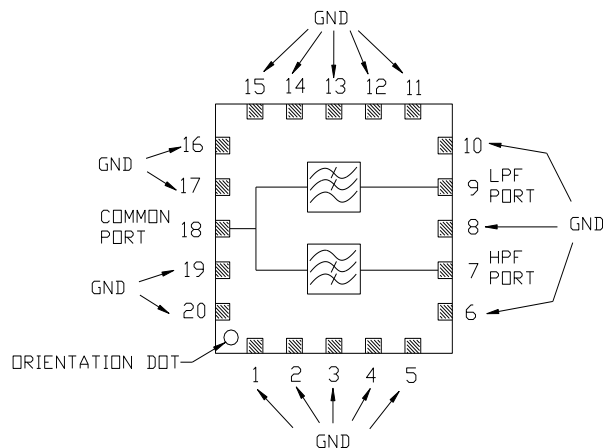

## Ordering Information

Part Number	Package
MAFL-011057	200

## Pin Configuration

Function	Pin Number
Common Port	18
Low Pass Port	9
High Pass Port	7
Ground	1 - 6, 8, 10-17, 19, 20
Not connected	-

**Electrical Specifications:  $T_A = 25^\circ\text{C}$ ,  $Z_0 = 75\Omega$**

Parameter	Units	Min	Typ	Max
<b>Insertion Loss</b> 5 - 85 MHz	dB	-	0.5	1.5
	102 - 1218 MHz		0.5	1.5
<b>Insertion Loss Flatness</b> 5 - 85 MHz	dB	-	-	0.8
<b>Filter Rejection</b> 5 - 85 MHz	dB	43	50	-
	102 - 1218 MHz	dB	43	50
<b>Filter Return Loss (all ports)</b> 5 - 85 MHz	dB	17	19	-
	102 - 1218 MHz	dB	16	18
<b>Group Delay</b> 81.5 - 85 MHz	nSec	-	-	20
	102 - 105.5 MHz	nSec	-	20

### Recommended Maximum Ratings

Parameter	Value
Storage Temperature	-40°C to +85°C
Operating Temperature	-40°C to +85°C
DC Current	30mA
RF Power	250mW



## CATV Diplex Filter 5-85 / 102-1218MHz

Rev. V2

Typical Performance:  $T_A = 25^\circ\text{C}$ ,  $Z_0 = 75\Omega$

### Input Port Return Loss

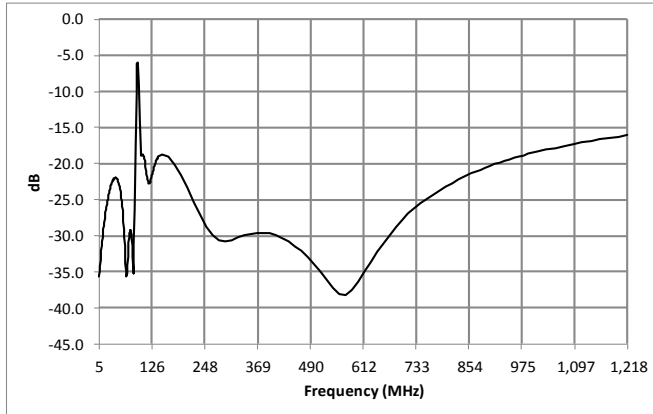

### Low Pass Filter Insertion Loss

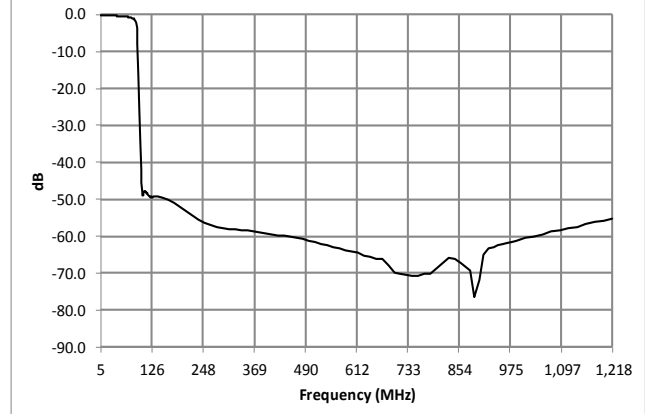

### High Pass Filter Insertion Loss

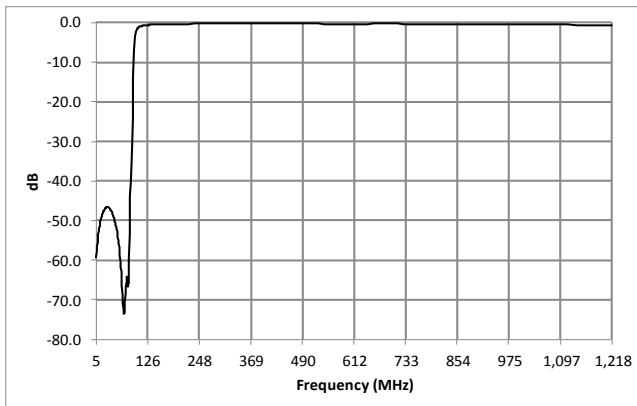

### Filter Isolation

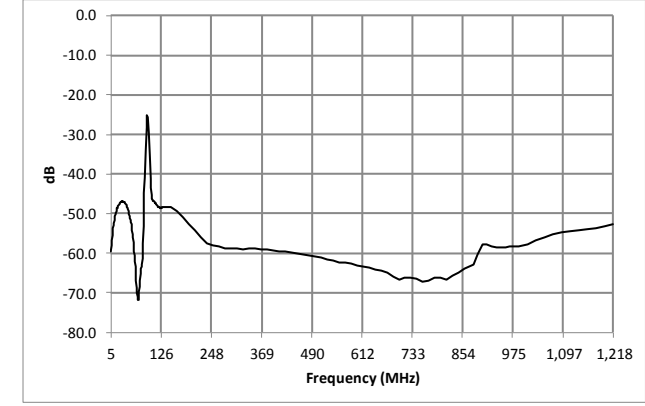

### Low Pass port Return Loss

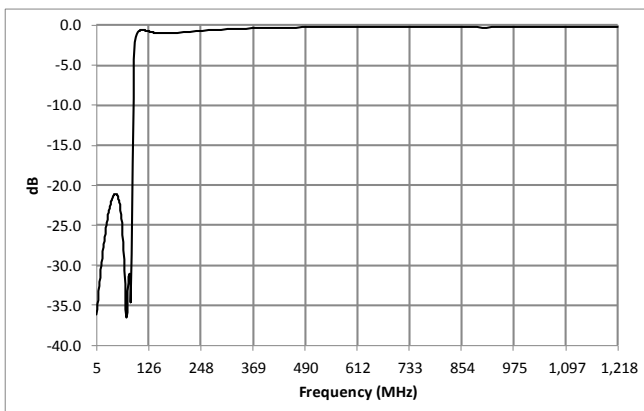

### High Pass port Return Loss

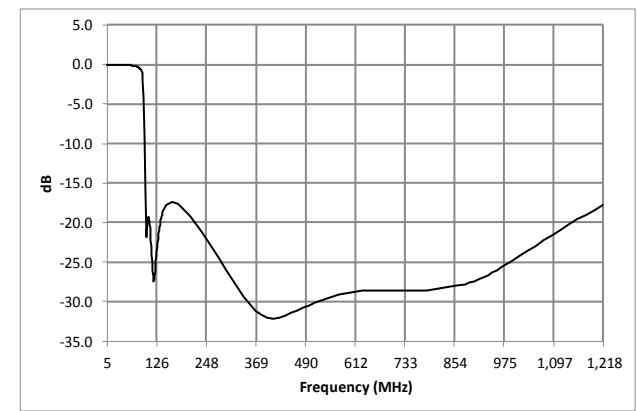



M/A-COM Technology Solutions Inc. All rights reserved.

Information in this document is provided in connection with M/A-COM Technology Solutions Inc ("MACOM") products. These materials are provided by MACOM as a service to its customers and may be used for informational purposes only. Except as provided in MACOM's Terms and Conditions of Sale for such products or in any separate agreement related to this document, MACOM assumes no liability whatsoever. MACOM assumes no responsibility for errors or omissions in these materials. MACOM may make changes to specifications and product descriptions at any time, without notice. MACOM makes no commitment to update the information and shall have no responsibility whatsoever for conflicts or incompatibilities arising from future changes to its specifications and product descriptions. No license, express or implied, by estoppels or otherwise, to any intellectual property rights is granted by this document.

THESE MATERIALS ARE PROVIDED "AS IS" WITHOUT WARRANTY OF ANY KIND, EITHER EXPRESS OR IMPLIED, RELATING TO SALE AND/OR USE OF MACOM PRODUCTS INCLUDING LIABILITY OR WARRANTIES RELATING TO FITNESS FOR A PARTICULAR PURPOSE, CONSEQUENTIAL OR INCIDENTAL DAMAGES, MERCHANTABILITY, OR INFRINGEMENT OF ANY PATENT, COPYRIGHT OR OTHER INTELLECTUAL PROPERTY RIGHT. MACOM FURTHER DOES NOT WARRANT THE ACCURACY OR COMPLETENESS OF THE INFORMATION, TEXT, GRAPHICS OR OTHER ITEMS CONTAINED WITHIN THESE MATERIALS. MACOM SHALL NOT BE LIABLE FOR ANY SPECIAL, INDIRECT, INCIDENTAL, OR CONSEQUENTIAL DAMAGES, INCLUDING WITHOUT LIMITATION, LOST REVENUES OR LOST PROFITS, WHICH MAY RESULT FROM THE USE OF THESE MATERIALS.

MACOM products are not intended for use in medical, lifesaving or life sustaining applications. MACOM customers using or selling MACOM products for use in such applications do so at their own risk and agree to fully indemnify MACOM for any damages resulting from such improper use or sale.

# Mouser Electronics

Authorized Distributor

Click to View Pricing, Inventory, Delivery & Lifecycle Information:

[MACOM:](#)

[MAFL-011057](#)