

Spezifikation für Freigabe / specification for release

Kunde / customer : _____
 Artikelnummer / part number : **744253200**
 Bezeichnung : **STROMKOMPENSIERTE SMD LINE FILTER WE-SL3**
 description : **COMMON MODE SMD LINE FILTER WE-SL3**



DATUM/DATE: 2004-04-26

A Mechanische Abmessungen / dimensions :

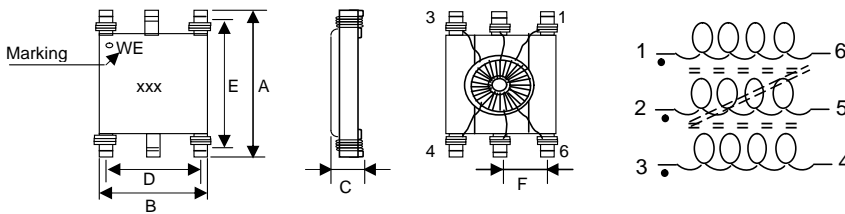

A	9,20 max.	mm
B	6,60 max.	mm
C	2,50 max.	mm
D	5,08 typ.	mm
E	7,24 typ.	mm
F	2,54 typ.	mm

B Elektrische Eigenschaften / electrical properties :

Eigenschaften / properties	Testbedingungen / test conditions		Wert / value	Einheit / unit	tol.
Induktivität / inductance	0,1V / 100KHz	$L_{1-6;2-5;3-4}$	20	μH	+50 / -30%
Streuinduktivität / differential inductance	0,1V / 100KHz	$ L-L $	3	μH	max.
DC-Widerstand / DC-resistance		R_{DC}	0,160	Ω	max.
Nennstrom / rated current	$\Delta T = 40\text{K}$	I_{DC}	500	mA	max.
Impedanz / impedance		Z_{com}	1250	Ω	max.
Nennspannung / rated voltage		U_{DC}	80	V	max.

C Lötpad / soldering spec. :

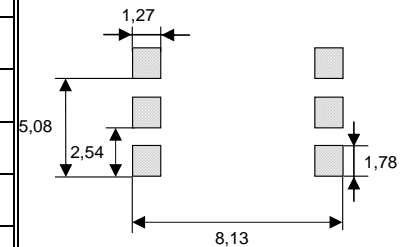

D Prüfgeräte / test equipment :

HP 4191 B für/for Z und/and material
HP 34401 A für/for R_{DC} und/and IDC

E Testbedingungen / test conditions :

Luftfeuchtigkeit / humidity: 33%
 Umgebungstemperatur / temperature: +20°C
 Spannungsfestigkeit / High-Pot Test (60Hz;1mA;1min.): 500VAC

F Werkstoffe & Zulassungen / material & approvals :

Basismaterial / base material: Ferrit / ferrite
 Draht / wire: 2-SFBW / 155°C
 Gehäuse / Housing: UL94-V0

G Eigenschaften / general specifications :

Betriebstemp. / operating temperature: -40°C - +125°C
 Umgebungstemp. / ambient temperature: -40°C - +85°C
 It is recommended that the temperature of the part does not exceed 125°C under worst case operating conditions.

Freigabe erteilt / general release:	Kunde / customer			
 Datum / date Unterschrift / signature		
Geprüft / checked	Würth Elektronik			
 Kontrolliert / approved	ME Name	Neugestaltung Änderung / modification	04-02-01 Datum / date

Würth Elektronik eiSos GmbH & Co. KG

D-74638 Waldenburg · Max-Eyth-Strasse 1 - 3 · Germany · Telefon (+49) (0) 7942 - 945 - 0 · Telefax (+49) (0) 7942 - 945 - 400
<http://www.we-online.com>

Spezifikation für Freigabe / specification for release

Kunde / customer : _____
 Artikelnummer / part number : **744253200**
 Bezeichnung : **STROMKOMPENSIERTE SMD LINE FILTER WE-SL3**
 description : **COMMON MODE SMD LINE FILTER WE-SL3**

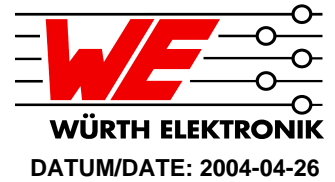

H Impedanzverlauf / impedance curve :

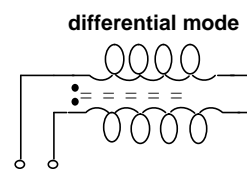
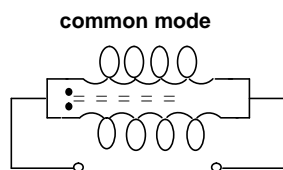
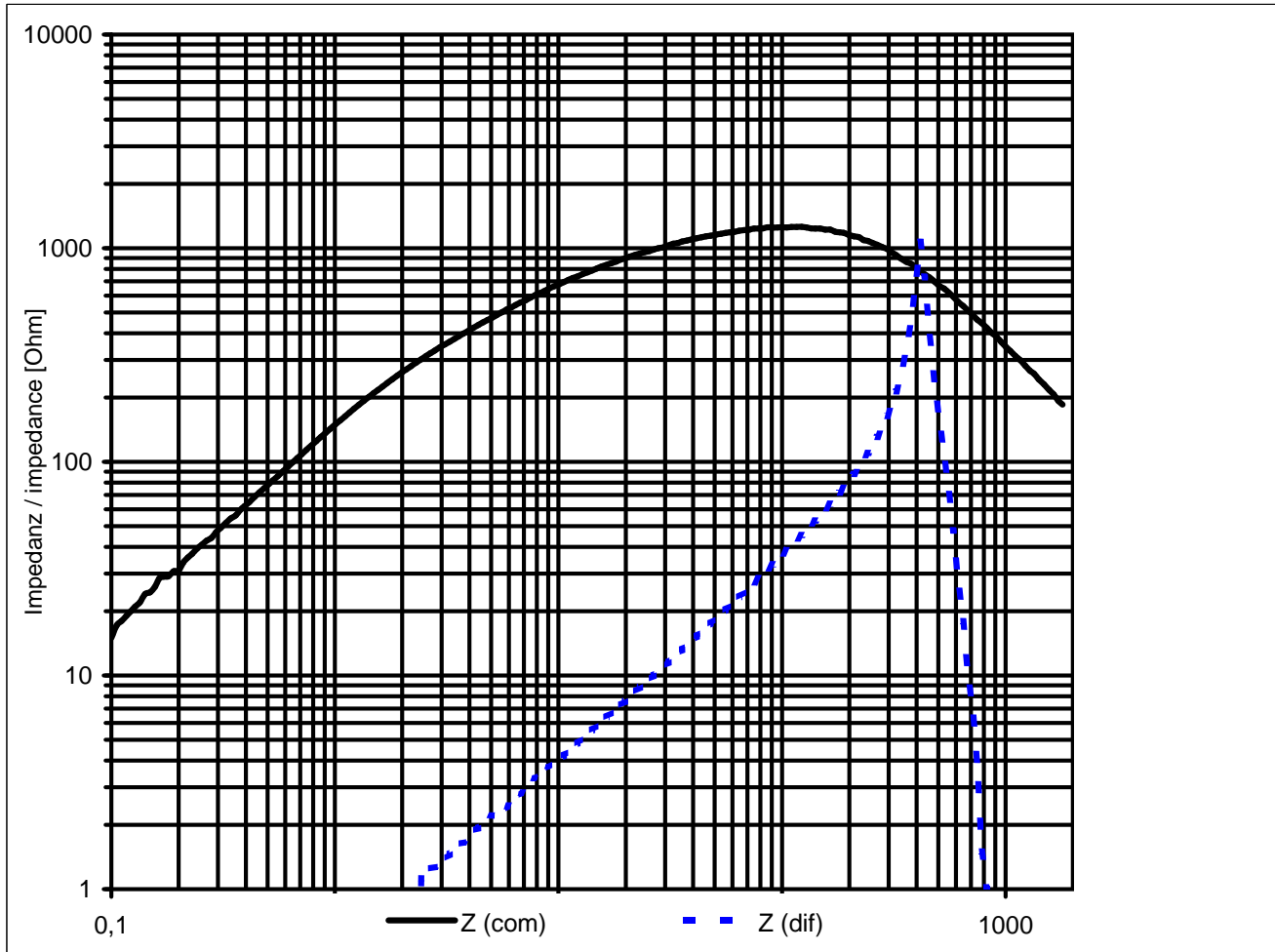

Freigabe erteilt / general release:	Kunde / customer			
Datum / date	Unterschrift / signature			
	Würth Elektronik			
Geprüft / checked	Kontrolliert / approved	ME	Neugestaltung	04-02-01
		Name	Änderung / modification	Datum / date

Würth Elektronik eiSos GmbH & Co. KG

D-74638 Waldenburg · Max-Eyth-Strasse 1 - 3 · Germany · Telefon (+49) (0) 7942 - 945 - 0 · Telefax (+49) (0) 7942 - 945 - 400
<http://www.we-online.com>

Spezifikation für Freigabe / specification for release

Kunde / customer : _____
 Artikelnummer / part number : **744253200**
 Bezeichnung : **STROMKOMPENSIERTE SMD LINE FILTER WE-SL3**
 description : **COMMON MODE SMD LINE FILTER WE-SL3**

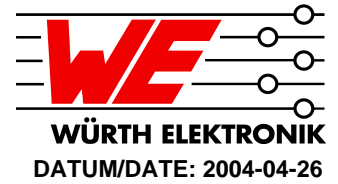

I Rollenspezifikation / tape and reel specification :

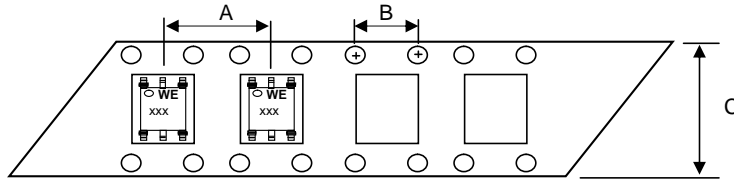

Gurtspezifikation / Tape specification:		
A	12 ± 1,0	mm
B	4 ± 1,0	mm
C	16 ± 1,0	mm
D		mm
E		mm
F		mm
G		mm
H		mm
I		mm
J		mm
T		mm

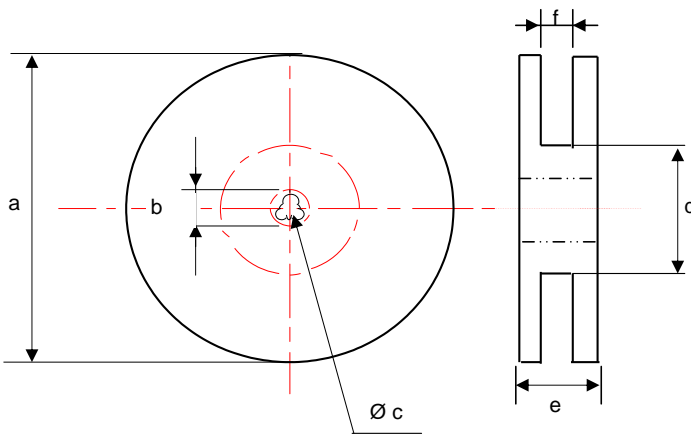

Rollenspezifikation / Reel specification:		
a	330 ± 2,0	mm
b	21 ± 0,8	mm
c	13 ± 0,5	mm
d	50 ± 1,0	mm
e	22,4	mm
f	18	mm

165 to 180°

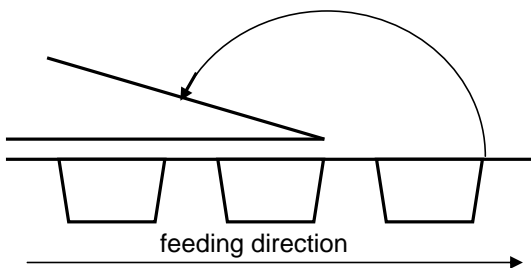

The force for tearing off cover tape is 10 to 130 grams in arrow direction

Freigabe erteilt / general release:	Kunde / customer			
		
Datum / date	Würth Elektronik			
.....			
Geprüft / checked	ME	Neugestaltung	04-02-01	
	Name	Änderung / modification	Datum / date
.....	Kontrolliert / approved			

Würth Elektronik eiSos GmbH & Co. KG

D-74638 Waldenburg · Max-Eyth-Strasse 1 - 3 · Germany · Telefon (+49) (0) 7942 - 945 - 0 · Telefax (+49) (0) 7942 - 945 - 400
<http://www.we-online.com>