

GaAs InGaP HBT MMIC ULTRA LOW PHASE NOISE, DISTRIBUTED AMPLIFIER, 2 - 18 GHz

Typical Applications

The HMC606 is ideal for:

- Radar, EW & ECM
- Microwave Radio
- Test Instrumentation
- Military & Space
- Fiber Optic Systems

Features

- Ultra Low Phase Noise: -160 dBc/Hz @ 10 kHz
- P1dB Output Power: +15 dBm
- Gain: 14 dB
- Output IP3: +27 dBm
- Supply Voltage: +5V @ 64 mA
- 50 Ohm Matched Input/Output
- Die Size: 2.80 x 1.73 x 0.1 mm

Functional Diagram

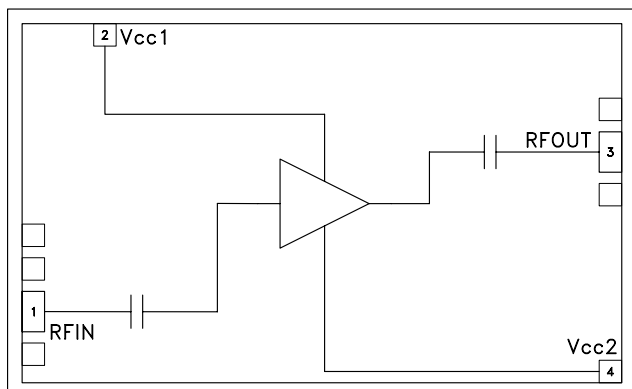

General Description

The HMC606 is a GaAs InGaP HBT MMIC Distributed Amplifier die which operates between 2 and 18 GHz. With an input signal of 12 GHz, the amplifier provides ultra low phase noise performance of -160 dBc/Hz at 10 kHz offset, representing a significant improvement over FET-based distributed amplifiers. The HMC606 provides 14 dB of small signal gain, +27 dBm output IP3 and +15 dBm of output power at 1 dB gain compression while requiring 64 mA from a +5V supply. The HMC606 amplifier I/Os are internally matched to 50 Ohms facilitating easy integration into Multi-Chip-Modules (MCMs). All data is taken with the chip in a 50 Ohm test fixture connected via 0.025 mm (1mil) diameter wire bonds of minimal length 0.31 mm (12 mils).

Electrical Specifications, $T_A = +25^\circ\text{C}$, $V_{cc1} = V_{cc2} = 5\text{V}$

Parameter	Min.	Typ.	Max.	Min.	Typ.	Max.	Units
Frequency Range	2 - 12		12 - 18				GHz
Gain	11	14.0		10	13		dB
Gain Flatness		± 1.0			± 1.0		dB
Gain Variation Over Temperature		0.021			0.25		dB/ $^\circ\text{C}$
Noise Figure		4.5			6.5		dB
Input Return Loss		20			22		dB
Output Return Loss		15			15		dB
Output Power for 1 dB Compression (P1dB)	12	15		10	13		dBm
Saturated Output Power (Psat)		18			15		dBm
Output Third Order Intercept (IP3)		27			22		dBm
Phase Noise @ 100 Hz		-140			-140		dBc/Hz
Phase Noise @ 1 kHz		-150			-150		dBc/Hz
Phase Noise @ 10 kHz		-160			-160		dBc/Hz
Phase Noise @ 1 MHz		-170			-170		dBc/Hz
Supply Current		64	95		64	95	mA

Information furnished by Analog Devices is believed to be accurate and reliable. However, no responsibility is assumed by Analog Devices for its use, nor for any infringements of patents or other rights of third parties that may result from its use. Specifications subject to change without notice. No license is granted by implication or otherwise under any patent or patent rights of Analog Devices. Trademarks and registered trademarks are the property of their respective owners.

For price, delivery, and to place orders: Analog Devices, Inc., One Technology Way, P.O. Box 9106, Norwood, MA 02062-9106 Phone: 781-329-4700 • Order online at www.analog.com Application Support: Phone: 1-800-ANALOG-D

GaAs InGaP HBT MMIC ULTRA LOW PHASE NOISE, DISTRIBUTED AMPLIFIER, 2 - 18 GHz

Gain & Return Loss

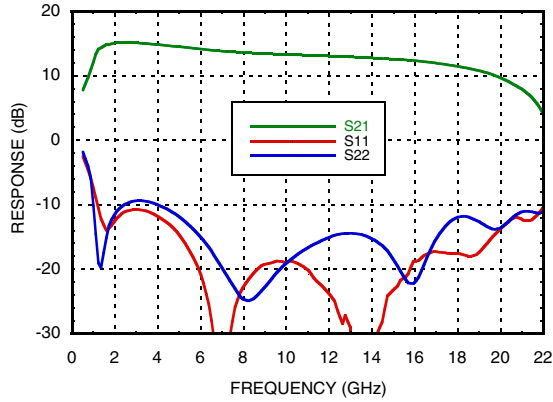

Gain vs. Temperature

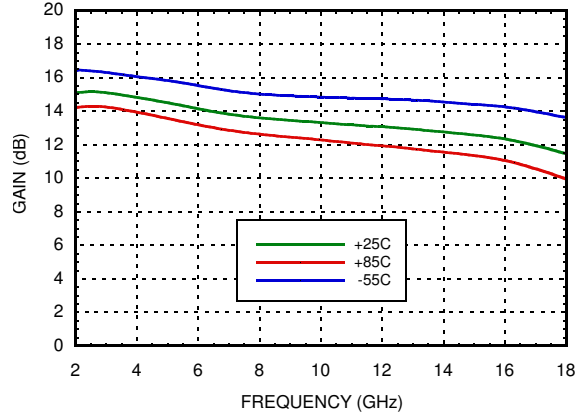

Input Return Loss vs. Temperature

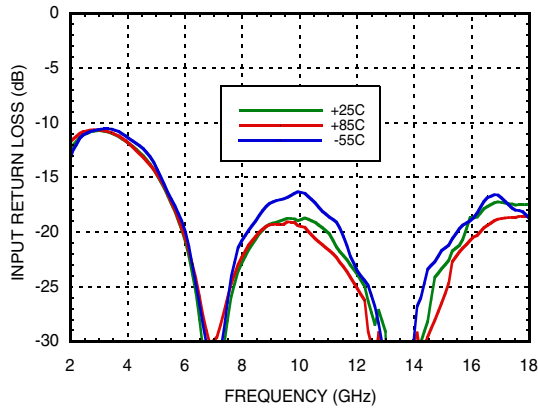

Output Return Loss vs. Temperature

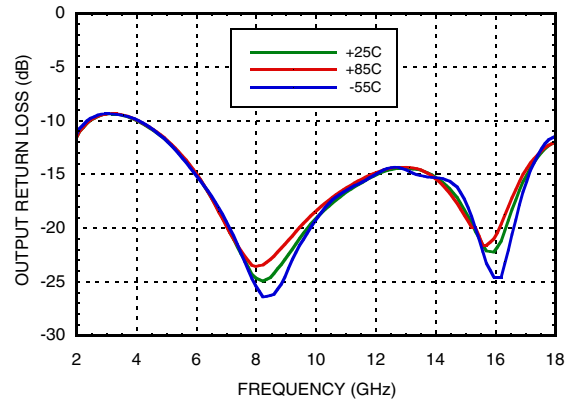

Power Compression

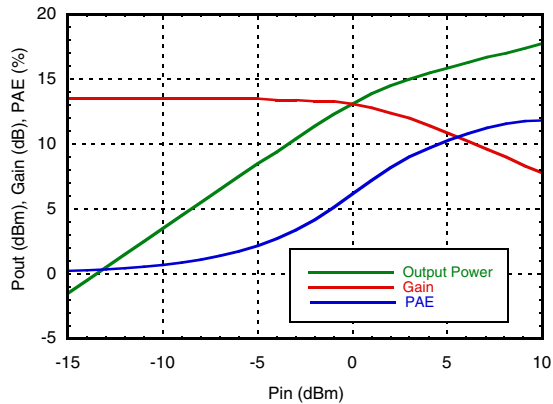

Noise Figure vs. Temperature

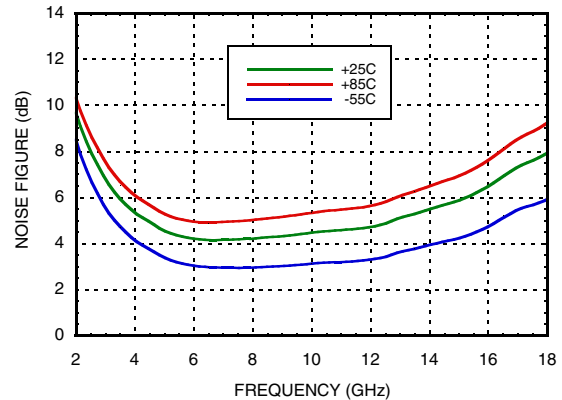

GaAs InGaP HBT MMIC ULTRA LOW PHASE NOISE, DISTRIBUTED AMPLIFIER, 2 - 18 GHz

LOW NOISE AMPLIFIERS - CHIP

P1dB vs. Temperature

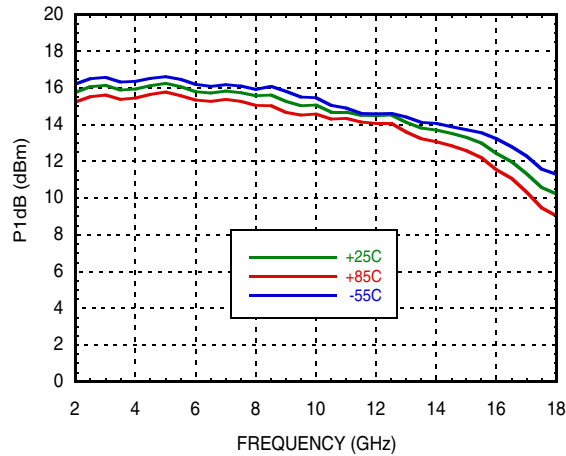

Psat vs. Temperature

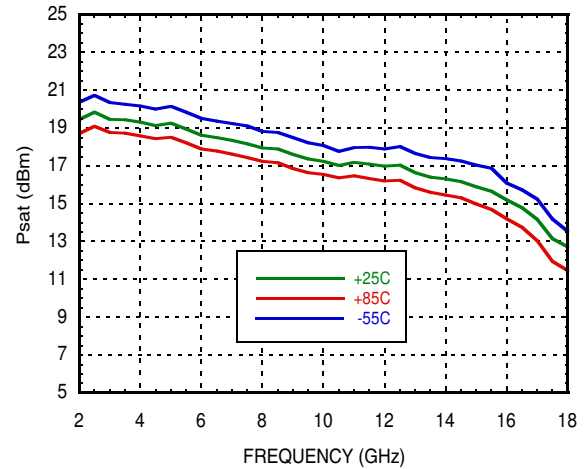

Output IP3 vs. Temperature

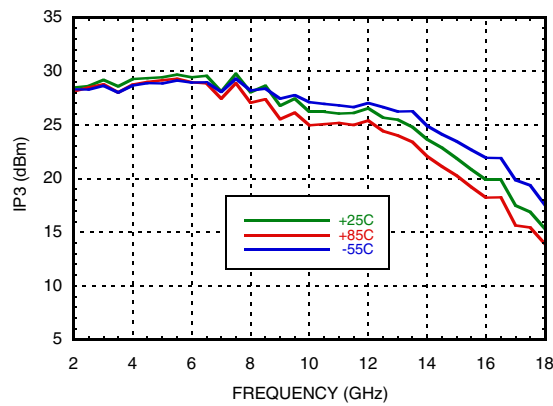

Additive Phase Noise vs. Offset Frequency, RF Frequency = 12 GHz, At Small Signal

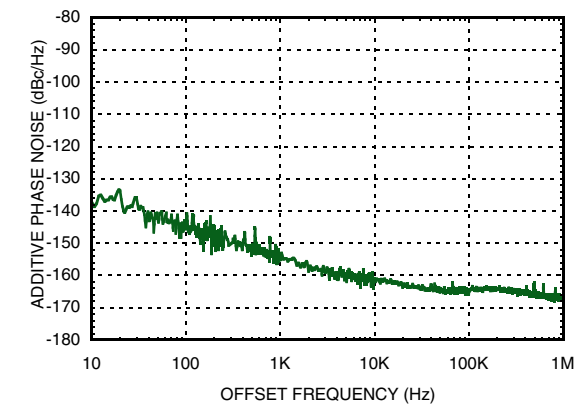

Additive Phase Noise Vs Offset Frequency, RF Frequency = 12 GHz, RF Input Power = 3 dBm (P1dB)

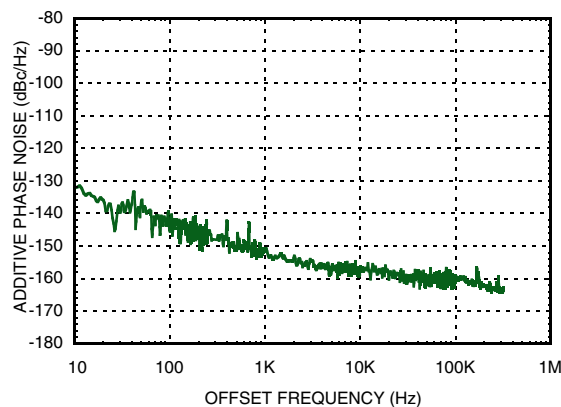

Additive Phase Noise Vs Offset Frequency, RF Frequency = 12 GHz, RF Input Power = 9 dBm (Psat)

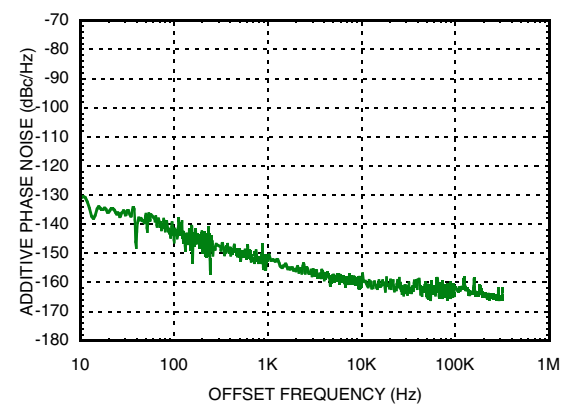

**GaAs InGaP HBT MMIC ULTRA LOW
PHASE NOISE, DISTRIBUTED AMPLIFIER, 2 - 18 GHz**

**Additive Phase Noise Vs Offset Frequency,
RF Frequency = 8 GHz,
RF Input Power = 12 dBm (P_{sat})**

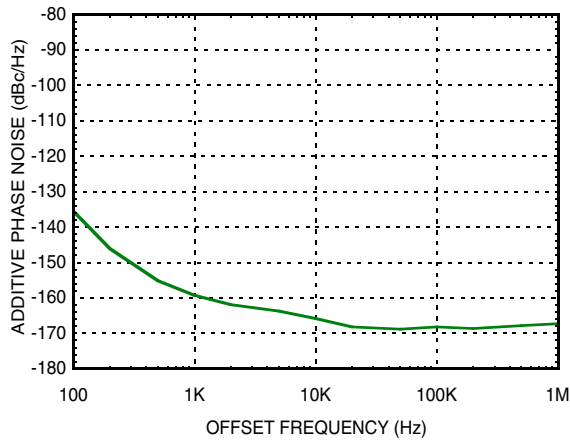

Notes:

GaAs InGaP HBT MMIC ULTRA LOW PHASE NOISE, DISTRIBUTED AMPLIFIER, 2 - 18 GHz

Absolute Maximum Ratings

Vdd1= Vdd2= 5V	7V
RF Input Power (RFIN)	+15 dBm
Channel Temperature	175 °C
Continuous Pdiss (T = 85 °C) (derate 14.6 mW/°C above 85 °C)	1.32 W
Thermal Resistance (channel to die bottom)	68.37 °C/W
Storage Temperature	-65 to +150 °C
Operating Temperature	-55 to +85 °C

Typical Supply Current vs. Vcc1, Vcc2

Vcc1= Vcc2 (V)	Icc1 + Icc2 (mA)
+4.5	53
+5.0	64
+5.5	74



ELECTROSTATIC SENSITIVE DEVICE
OBSERVE HANDLING PRECAUTIONS

Outline Drawing

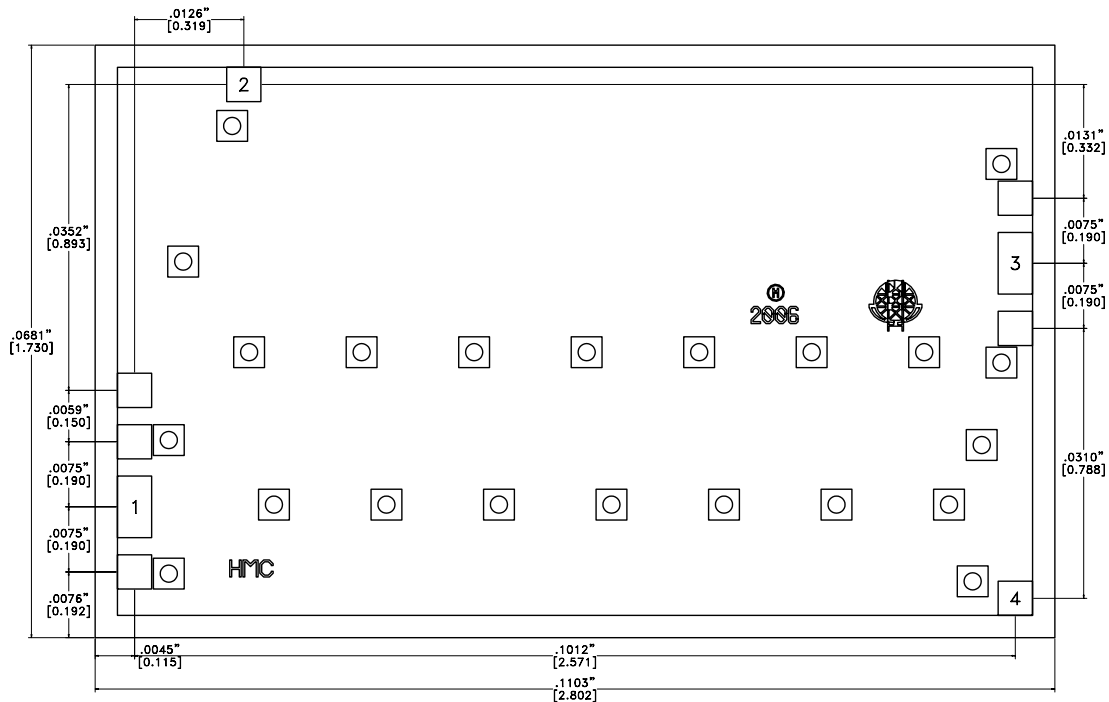

Die Packaging Information [1]

Standard	Alternate
GP-1 (Gel Pack)	[2]

[1] Refer to the "Packaging Information" section for die packaging dimensions.

[2] For alternate packaging information contact Hittite Microwave Corporation.

NOTES:

- ALL DIMENSIONS IN INCHES [MILLIMETERS]
- NO CONNECTION REQUIRED FOR UNLABELED BOND PADS
- DIE THICKNESS IS 0.004 (0.100)
- TYPICAL BOND PAD IS 0.004 (0.100) SQUARE
- BACKSIDE METALLIZATION: GOLD
- BACKSIDE METAL IS GROUND
- BOND PAD METALIZATION: GOLD

For price, delivery, and to place orders: Analog Devices, Inc., One Technology Way, P.O. Box 9106, Norwood, MA 02062-9106

Phone: 781-329-4700 • Order online at www.analog.com

Application Support: Phone: 1-800-ANALOG-D

GaAs InGaP HBT MMIC ULTRA LOW PHASE NOISE, DISTRIBUTED AMPLIFIER, 2 - 18 GHz

Pad Descriptions

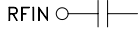
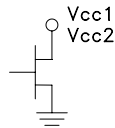
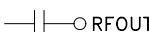
Pad Number	Function	Description	Interface Schematic
1	RFIN	This Pad is AC coupled and matched to 50 Ohms.	RFIN 
2, 4	Vcc1, Vcc2	Vcc1= Vcc2= 5V	
3	RFOUT	This Pad is AC coupled and matched to 50 Ohms.	

Assembly Diagram

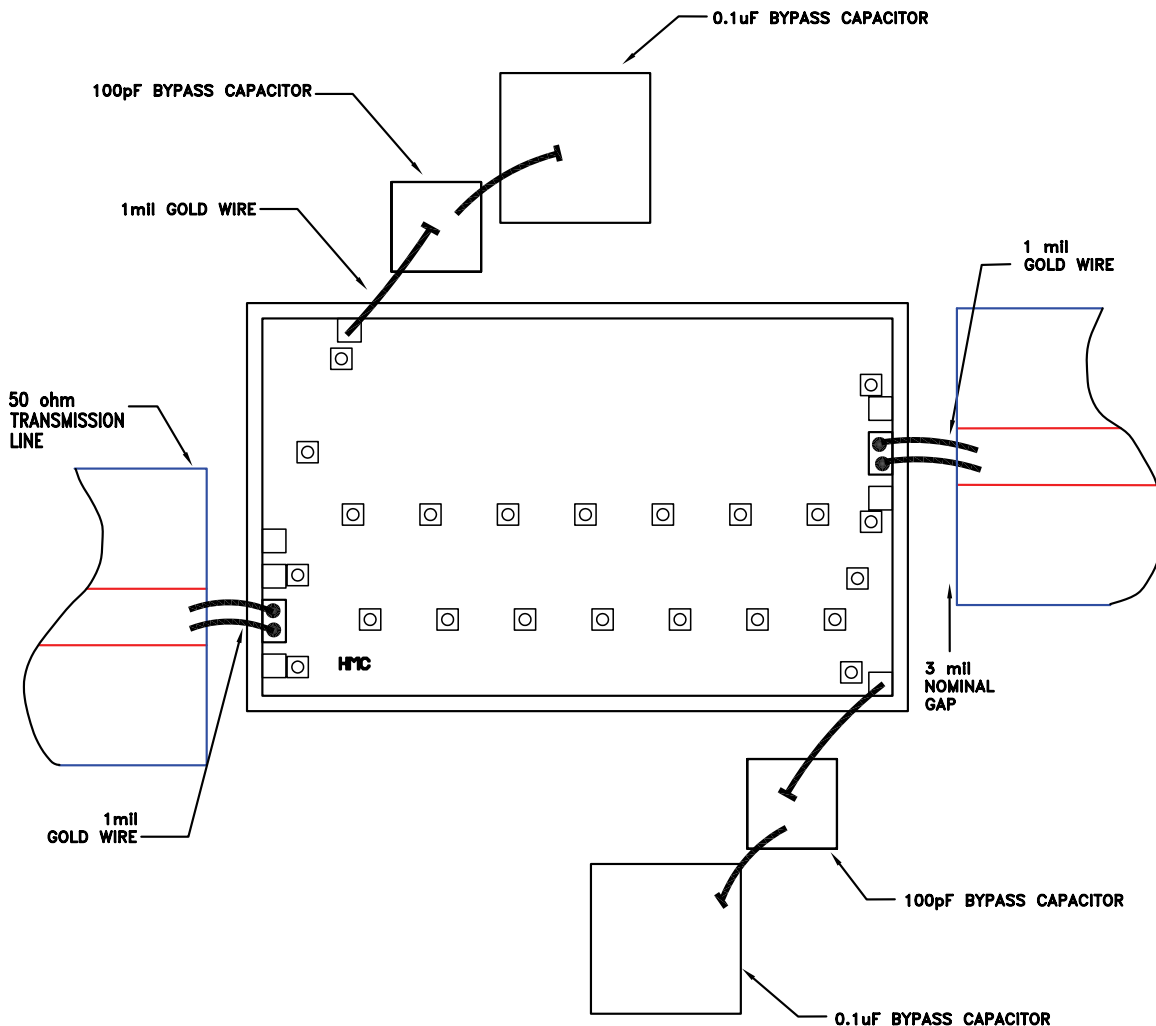

GaAs InGaP HBT MMIC ULTRA LOW PHASE NOISE, DISTRIBUTED AMPLIFIER, 2 - 18 GHz

Mounting & Bonding Techniques for Millimeterwave GaAs MMICs

The die should be attached directly to the ground plane eutectically or with conductive epoxy (see HMC general Handling, Mounting, Bonding Note).

50 Ohm Microstrip transmission lines on 0.127mm (5 mil) thick alumina thin film substrates are recommended for bringing RF to and from the chip (Figure 1). If 0.254mm (10 mil) thick alumina thin film substrates must be used, the die should be raised 0.150mm (6 mils) so that the surface of the die is coplanar with the surface of the substrate. One way to accomplish this is to attach the 0.102mm (4 mil) thick die to a 0.150mm (6 mil) thick molybdenum heat spreader (moly-tab) which is then attached to the ground plane (Figure 2).

Microstrip substrates should be brought as close to the die as possible in order to minimize bond wire length. Typical die-to-substrate spacing is 0.076mm to 0.152 mm (3 to 6 mils).

Handling Precautions

Follow these precautions to avoid permanent damage.

Storage: All bare die are placed in either Waffle or Gel based ESD protective containers, and then sealed in an ESD protective bag for shipment. Once the sealed ESD protective bag has been opened, all die should be stored in a dry nitrogen environment.

Cleanliness: Handle the chips in a clean environment. DO NOT attempt to clean the chip using liquid cleaning systems.

Static Sensitivity: Follow ESD precautions to protect against ESD strikes.

Transients: Suppress instrument and bias supply transients while bias is applied. Use shielded signal and bias cables to minimize inductive pick-up.

General Handling: Handle the chip along the edges with a vacuum collet or with a sharp pair of bent tweezers. The surface of the chip has fragile air bridges and should not be touched with vacuum collet, tweezers, or fingers.

Mounting

The chip is back-metallized and can be die mounted with electrically conductive epoxy. The mounting surface should be clean and flat.

Epoxy Die Attach: Apply a minimum amount of epoxy to the mounting surface so that a thin epoxy fillet is observed around the perimeter of the chip once it is placed into position. Cure epoxy per the manufacturer's schedule.

Wire Bonding

Ball or wedge bond with 0.025mm (1 mil) diameter pure gold wire. Thermosonic wirebonding with a nominal stage temperature of 150 °C and a ball bonding force of 40 to 50 grams or wedge bonding force of 18 to 22 grams is recommended. Use the minimum level of ultrasonic energy to achieve reliable wirebonds. Wirebonds should be started on the chip and terminated on the package or substrate. All bonds should be as short as possible <0.31mm (12 mils).

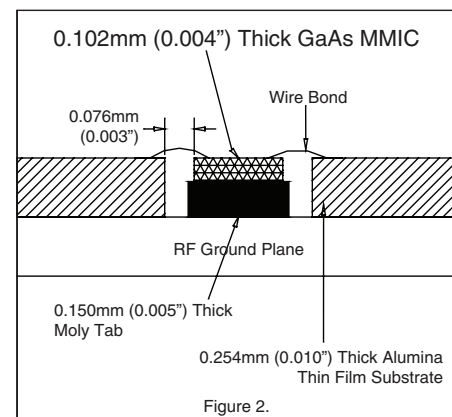
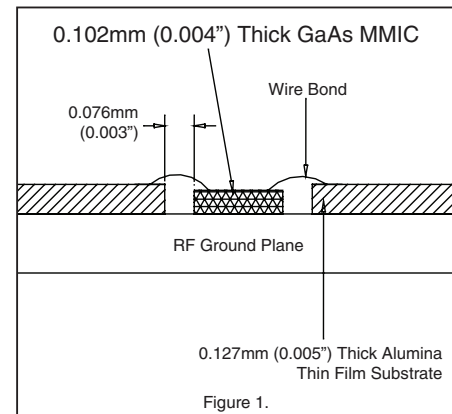

Mouser Electronics

Authorized Distributor

Click to View Pricing, Inventory, Delivery & Lifecycle Information:

[Analog Devices Inc.:](#)

[HMC606LC5](#) [HMC606LC5TR](#)