

HCMA1707

Automotive grade High current power inductors



Product features

- AEC-Q200 qualified
- High current carrying capacity
- Magnetically shielded, low EMI
- Frequency range up to 1 MHz
- Inductance range from 1.5 μ H to 68 μ H
- Current range from 5.2 A to 40 A
- 17.5 mm x 17.2 mm footprint surface mount package in a 7.0 mm height
- Iron powder core material

Applications

- Body electronics
 - Central body control module
 - Headlamps, tail lamps and interior lighting
 - Heating ventilation and air conditioning controllers (HVAC)
 - Doors, window lift and seat control
- Advanced driver assistance systems
 - Adaptive cruise control (ACC)
 - Automatic parking control
 - Collision avoidance system
 - Car black box system
- Infotainment and cluster electronics
 - Audio subsystem: head unit and trunk amp
 - Digital instrument cluster
 - In-vehicle infotainment (IVI) and navigation
- Chassis and safety electronics
 - Airbag control unit
 - Electronic stability control system (ESC)
 - Electric parking brake
 - Electronic Power Steering (EPS)
 - Anti-Lock Braking System (ABS)

Environmental Data

- Storage temperature range (Component): -55 °C to +125 °C
- Operating temperature range: -55 °C to +125 °C (ambient plus self-temperature rise)
- Solder reflow temperature: J-STD-020 (latest revision) compliant



Product Specifications

Part Number ⁶	OCL ¹ ±20% (μH)	FLL min. ² (μH)	I _{rms} ³ (A)	I _{sat} ⁴ (A)	DCR (mΩ) @ +20 °C (typical)	DCR (mΩ) @ +20 °C (maximum)	K-factor ⁵
HCMA1707-1R5-R	1.5	0.96	40	40	1.85	2.15	124
HCMA1707-2R2-R	2.2	1.41	37	34	2.15	2.50	103
HCMA1707-4R7-R	4.7	3.01	27	24	4.12	4.72	76
HCMA1707-6R8-R	6.8	4.35	20	22	6.55	7.55	60
HCMA1707-8R2-R	8.2	5.25	16	20	8.10	8.70	55
HCMA1707-100-R	10	6.40	14	18	9.30	10	47
HCMA1707-150-R	15	9.60	12	13	14.5	15.5	43
HCMA1707-220-R	22	14.1	9.5	11	21	23	37
HCMA1707-330-R	33	21.1	9.0	10	35	37	28
HCMA1707-470-R	47	30.1	6.8	7.5	41	47	25
HCMA1707-680-R	68	43.5	5.2	6.5	74	85	20

1. Open Circuit Inductance (OCL) Test Parameters: 100 kHz, 0.25 V_{rms}, 0.0 Adc, +25 °C.
2. Full Load Inductance (FLL): Test parameters: 100 kHz, 0.25 V_{rms}, I_{sat} +25 °C.
3. I_{rms}: DC current for an approximate temperature rise of 40 °C without core loss. Derating is necessary for AC currents. PCB layout, trace thickness and width, air-flow, and proximity of other heat generating components will affect the temperature rise. It is recommended that the temperature of the part not exceed +125 °C under worst case operating conditions verified in the end application.
4. I_{sat}: Peak current for approximately 20% rolloff at +25 °C.

5. K-factor: Used to determine B_{pp} for core loss (see graph). B_{pp} = K * L * ΔI. B_{pp}:(Gauss), K: (K-factor from table), L: (Inductance in μH), ΔI (Peak to peak ripple current in amps).
6. Part Number Definition: HCMA1707-yyy-R
 - HCMA1707 = Product code and size
 yyy= Inductance value in uH, R = decimal point,
 if no R is present then third character = number of zeros.
 - "-R" suffix = RoHS compliant

Dimensions (mm)

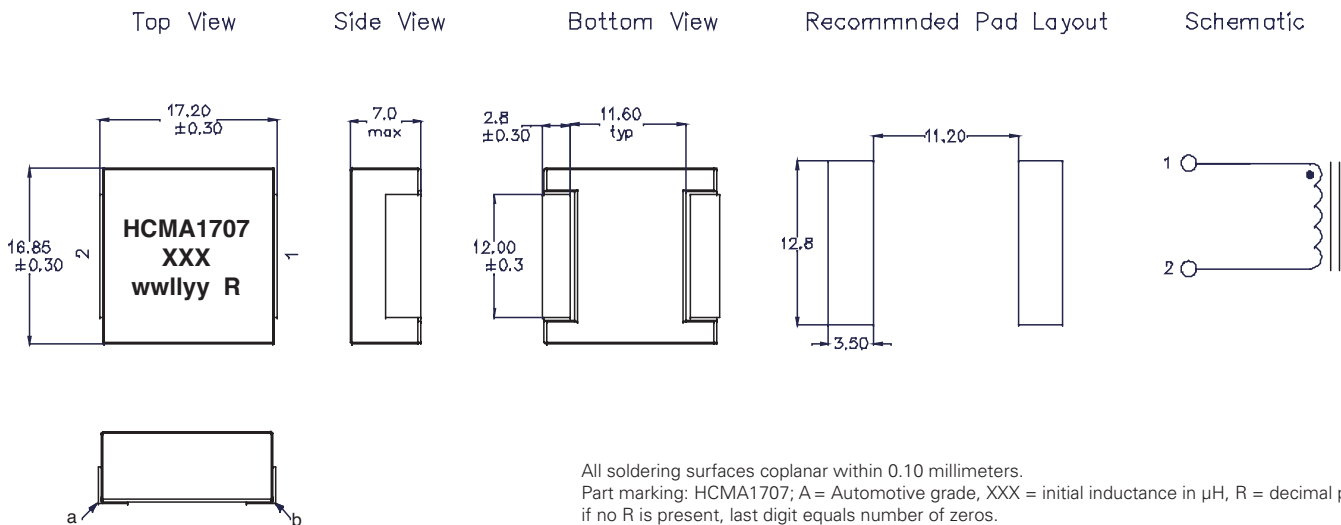

DCR measured between point "a" and point "b"

All soldering surfaces coplanar within 0.10 millimeters.
 Part marking: HCMA1707; A = Automotive grade, XXX = initial inductance in μH, R = decimal point;
 if no R is present, last digit equals number of zeros.
 wwlllyy = date code, R = revision level
 Color: Grey
 Do not route traces or vias underneath the inductor

Packaging information (mm)

Supplied in tape and reel packaging , 350 parts per 13" diameter reel

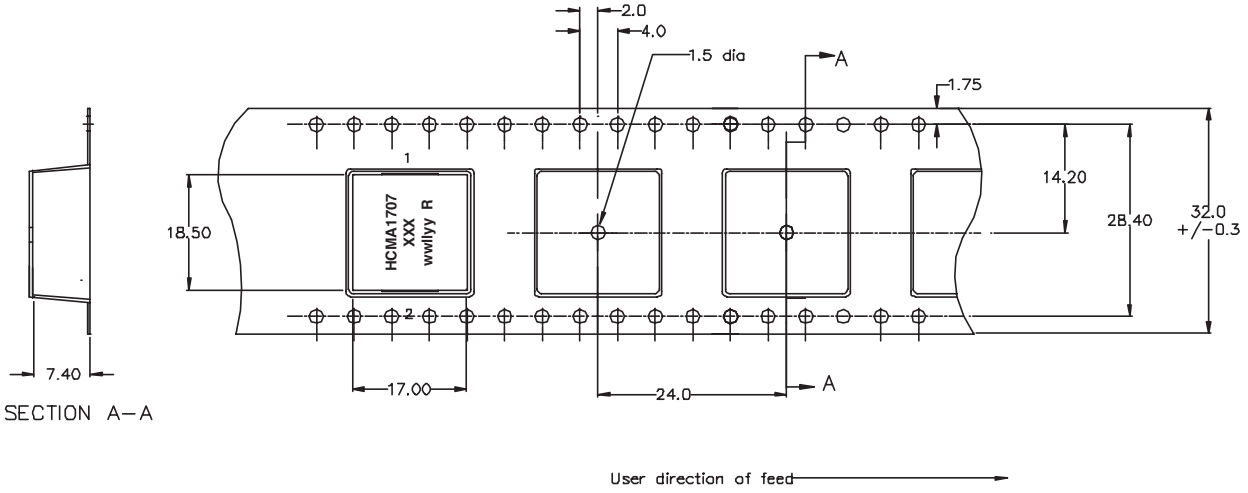

Temperature rise vs. total loss

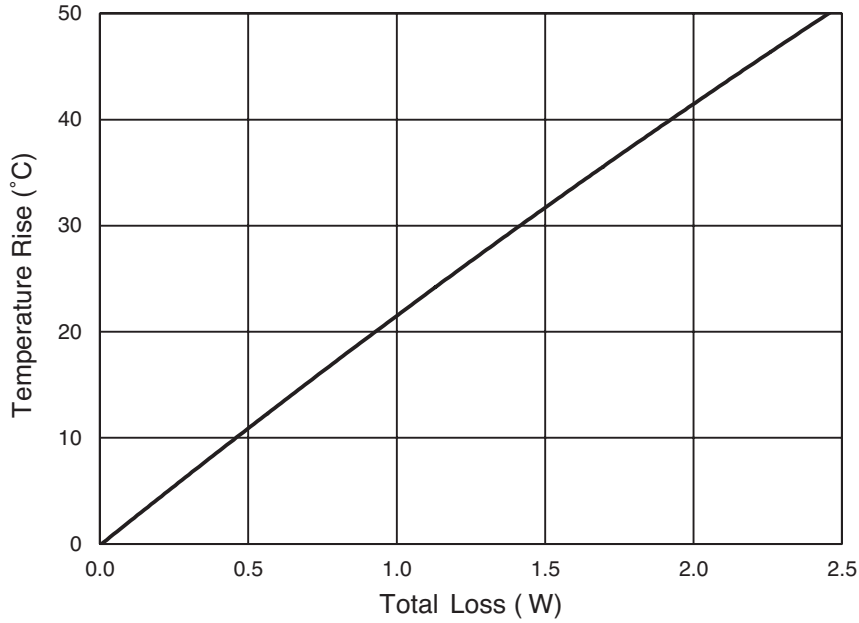

Core loss vs. B_{p-p}

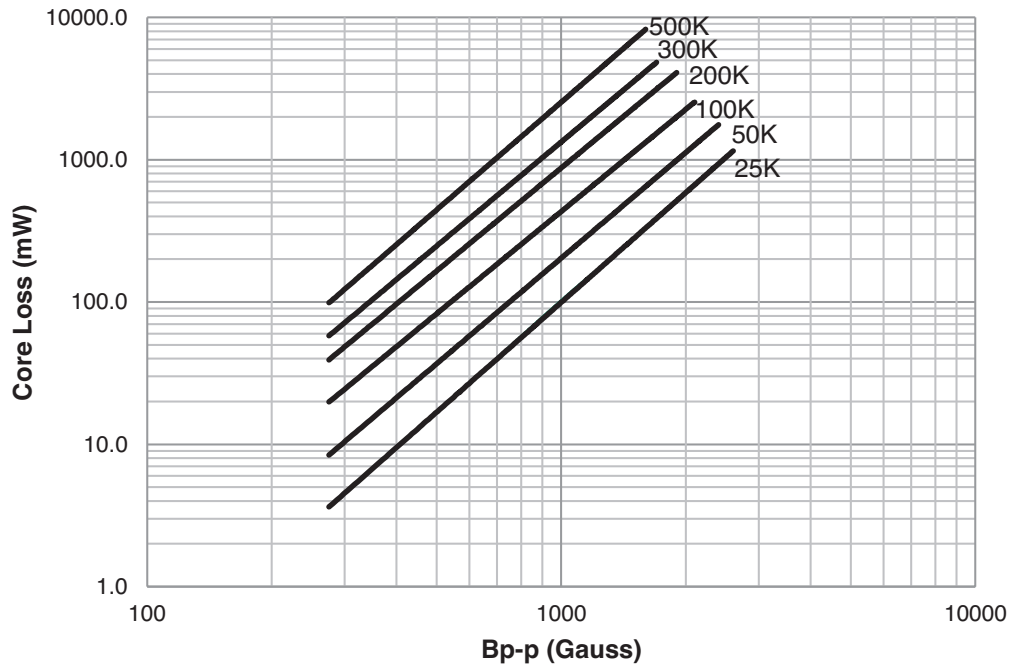

Inductance characteristics

HCMA1707 -1R5-R

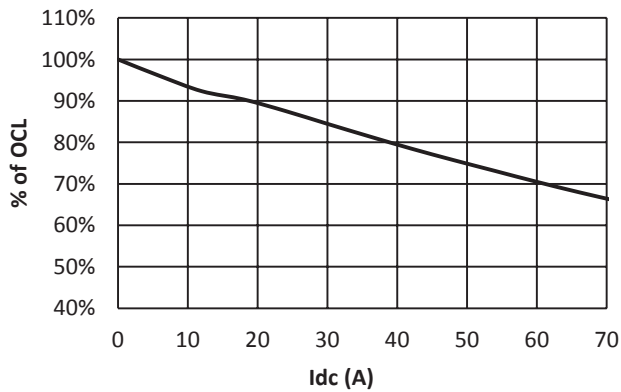

HCMA1707 -2R2-R

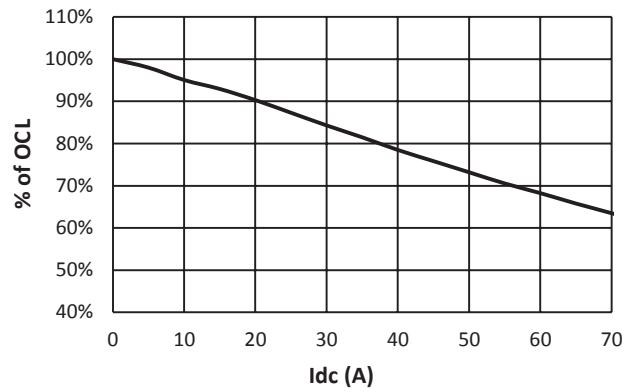

Inductance characteristics

HCMA1707 -4R7-R

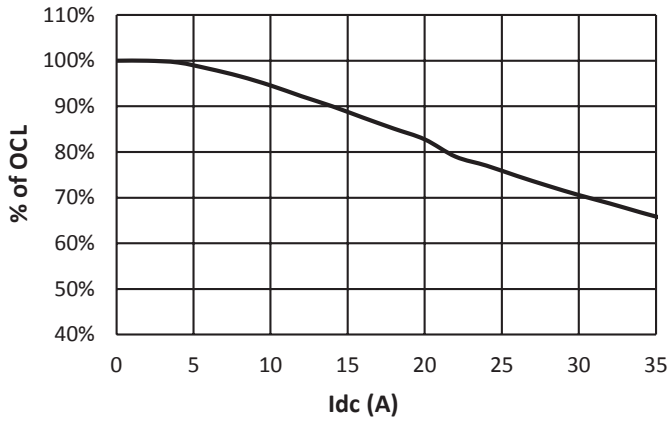

HCMA1707 -6R8-R

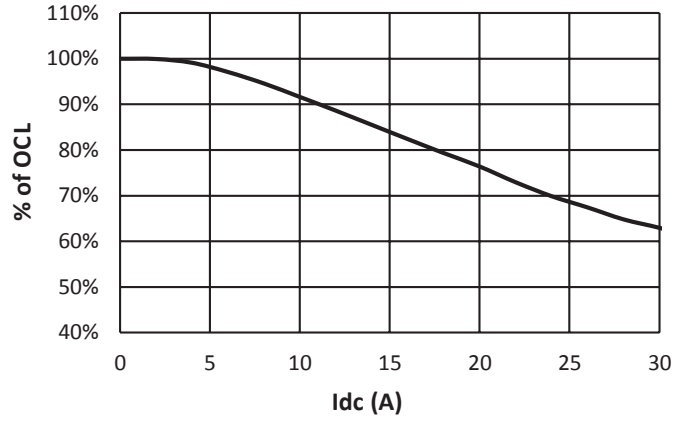

HCMA1707 -8R2-R

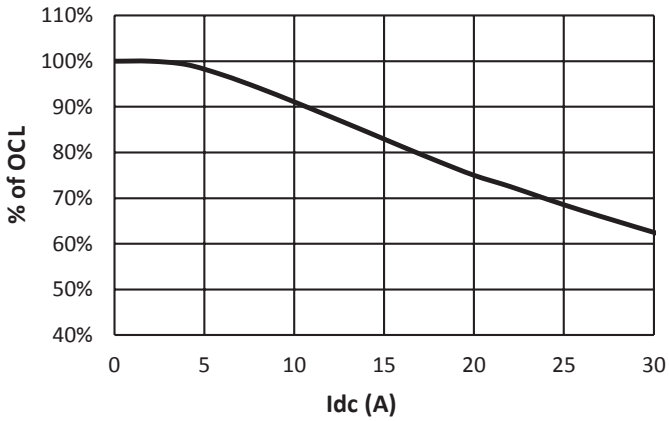

HCMA1707 -100-R

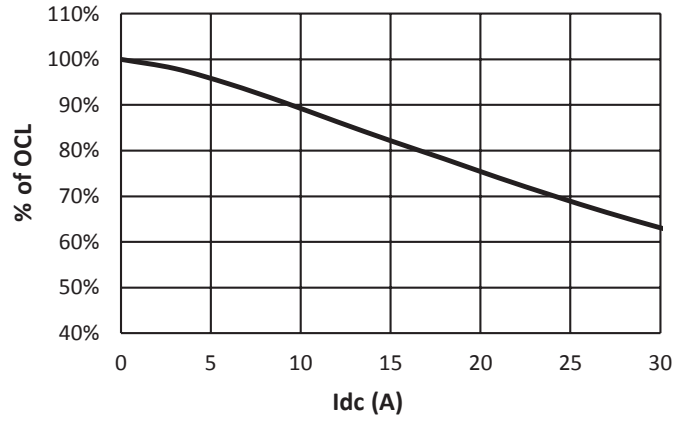

HCMA1707 -150-R

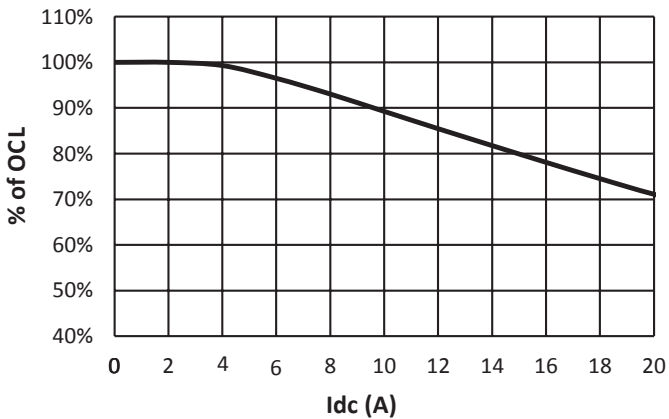

HCMA1707 -220-R

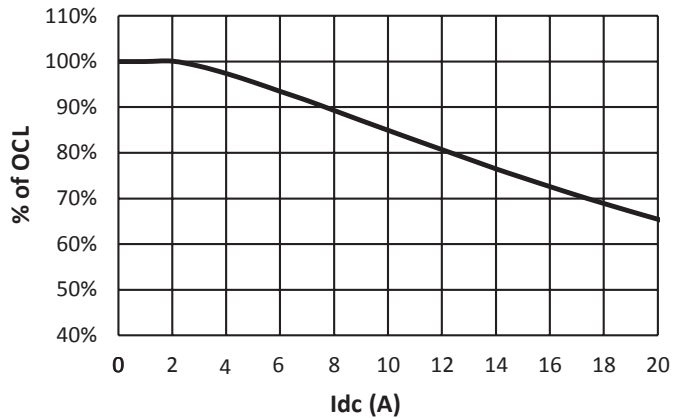

Inductance characteristics

HCMA1707-330-R

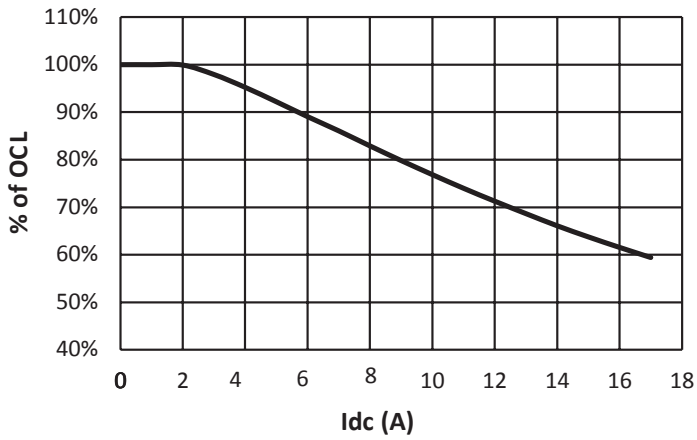

HCMA1707-470-R

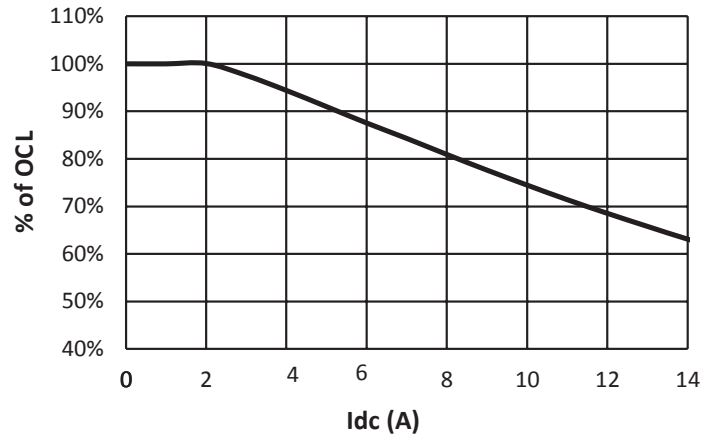

HCMA1707-680-R

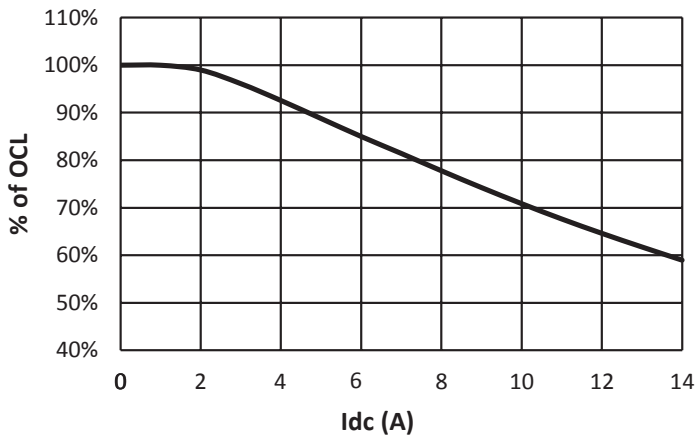

Solder reflow profile

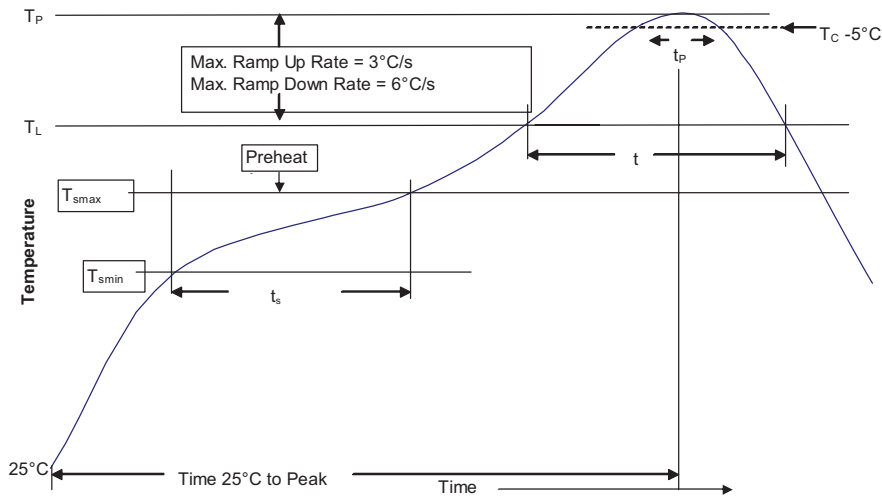

Table 1 - Standard SnPb Solder (T_c)

Package Thickness	Volume mm ³ <350	Volume mm ³ ≥350
<2.5mm)	235°C	220°C
≥2.5mm	220°C	220°C

Table 2 - Lead (Pb) Free Solder (T_c)

Package Thickness	Volume mm ³ <350	Volume mm ³ 350 - 2000	Volume mm ³ >2000
<1.6mm	260°C	260°C	260°C
1.6 – 2.5mm	260°C	250°C	245°C
>2.5mm	250°C	245°C	245°C

Reference JEDEC J-STD-020

Profile Feature	Standard SnPb Solder	Lead (Pb) Free Solder
Preheat and Soak		
• Temperature min. (T_{smin})	100°C	150°C
• Temperature max. (T_{smax})	150°C	200°C
• Time (T_{smin} to T_{smax}) (t_s)	60-120 Seconds	60-120 Seconds
Average ramp up rate T_{smax} to T_p	3°C/ Second Max.	3°C/ Second Max.
Liquidous temperature (T_L)	183°C	217°C
Time at liquidous (t_L)	60-150 Seconds	60-150 Seconds
Peak package body temperature (T_p)*	Table 1	Table 2
Time (t_p)** within 5 °C of the specified classification temperature (T_c)	20 Seconds**	30 Seconds**
Average ramp-down rate (T_p to T_{smax})	6°C/ Second Max.	6°C/ Second Max.
Time 25°C to Peak Temperature	6 Minutes Max.	8 Minutes Max.

* Tolerance for peak profile temperature (T_p) is defined as a supplier minimum and a user maximum.

** Tolerance for time at peak profile temperature (t_p) is defined as a supplier minimum and a user maximum.

Life Support Policy: Eaton does not authorize the use of any of its products for use in life support devices or systems without the express written approval of an officer of the Company. Life support systems are devices which support or sustain life, and whose failure to perform, when properly used in accordance with instructions for use provided in the labeling, can be reasonably expected to result in significant injury to the user.

Eaton reserves the right, without notice, to change design or construction of any products and to discontinue or limit distribution of any products. Eaton also reserves the right to change or update, without notice, any technical information contained in this bulletin.

Eaton
Electronics Division
1000 Eaton Boulevard
Cleveland, OH 44122
United States
www.eaton.com/electronics

© 2017 Eaton
All Rights Reserved
Printed in USA
Publication No. 10296 BU-SB14601
October 2017

Eaton is a registered trademark.

All other trademarks are property of their respective owners.

Mouser Electronics

Authorized Distributor

Click to View Pricing, Inventory, Delivery & Lifecycle Information:

[Eaton:](#)

[HCMA1707-680-R](#) [HCMA1707-6R8-R](#) [HCMA1707-330-R](#) [HCMA1707-1R5-R](#) [HCMA1707-220-R](#) [HCMA1707-100-R](#)
[HCMA1707-470-R](#) [HCMA1707-4R7-R](#) [HCMA1707-2R2-R](#) [HCMA1707-8R2-R](#) [HCMA1707-150-R](#)