

## SS24BF-HF Thru. SS220BF-HF

Reverse Voltage: 40 to 200 Volts

Forward Current: 2.0 Amp

RoHS Device

Halogen Free

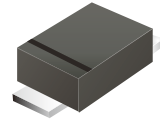

### Features

- Metal silicon junction, majority carrier conduction.
- For surface mounted applications.
- Low power loss, high efficiency.
- High forward surge current capability.
- For use in low voltage, high frequency inverters, free wheeling, and polarity protection applications.

### Mechanical data

- Case: SMBF
- Terminals: Solderable per MIL-STD-750, method 2026.

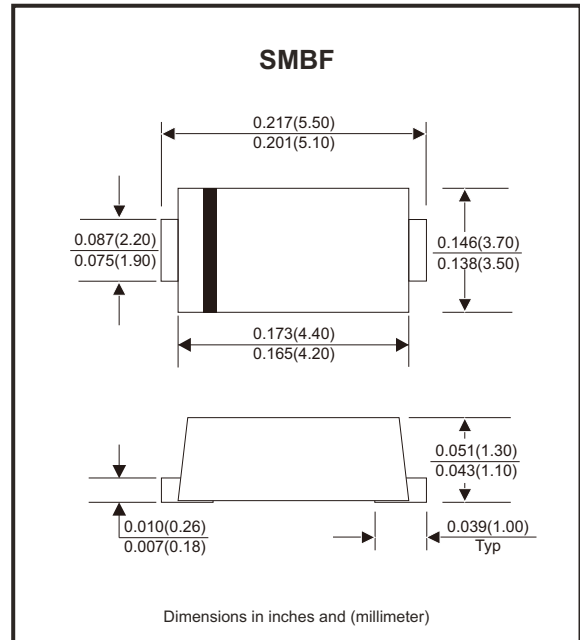

### Circuit Diagram



### Maximum Ratings and Electrical Characteristics

Ratings at 25°C ambient temperature unless otherwise specified.  
Single phase, half wave, 60Hz resistive or inductive load, for capacitive load, derate by 20%

Parameter	Symbols	SS24BF-HF	SS26BF-HF	SS210BF-HF	SS215BF-HF	SS220BF-HF	Units
Maximum repetitive peak reverse voltage	$V_{RRM}$	40	60	100	150	200	V
Maximum RMS voltage	$V_{RMS}$	28	42	70	105	140	V
Maximum DC blocking voltage	$V_{DC}$	40	60	100	150	200	V
Maximum average forward rectified current	$I_{F(AV)}$	2					A
Peak forward surge current, 8.3ms single half sine-wave superimposed on rated load (JEDEC method)	$I_{FSM}$	55		45			A
Max instantaneous forward voltage at 2A	$V_F$	0.55	0.70	0.85	0.95		V
Maximum DC reverse current at rated DC reverse voltage	$I_R$	$T_J = 25^\circ C$ 0.5		$T_J = 100^\circ C$ 0.3			mA
Typical junction capacitance (Note 1)	$C_j$	220		110			pF
Typical thermal resistance (Note 2)	$R_{\theta JA}$	75					°C/W
Operating junction temperature range	$T_J$	-55 ~ +150					°C
Storage temperature range	$T_{stg}$	-55 ~ +150					°C

Notes: 1. Measured at 1 MHz and applied reverse voltage of 4 V D.C  
2. P.C.B. mounted with 2.0" X 2.0" (5 X 5 cm) copper pad areas.

Company reserves the right to improve product design , functions and reliability without notice.

REV:A

## Rating and Characteristic Curves (SS24BF-HF Thru. SS220BF-HF)

Fig.1 - Forward Current Derating Curve

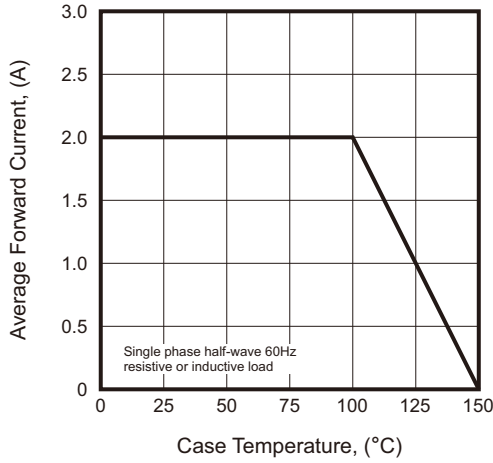

Fig.2 - Typical Reverse Characteristics

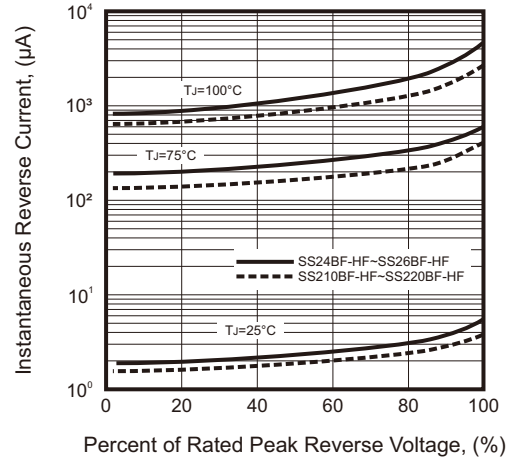

Fig.3 - Typical Forward Characteristic

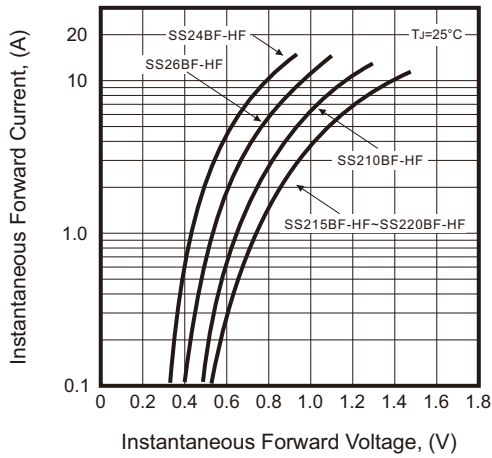

Fig.4 - Typical Junction Capacitance

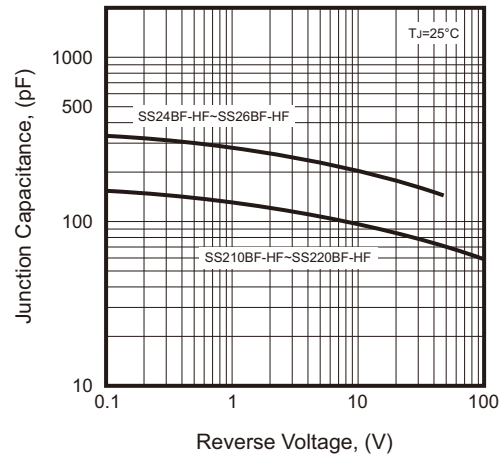

Fig.5 - Maximum Non-Repetitive Peak Forward Surge Current

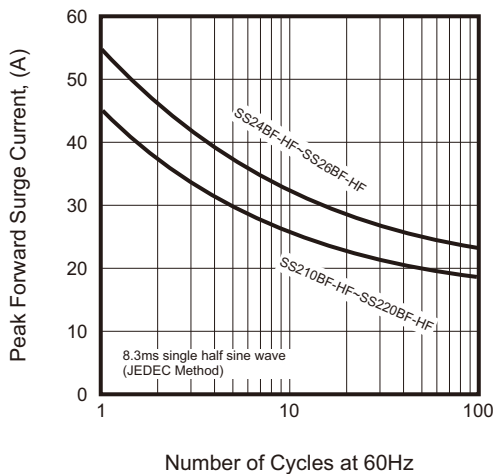
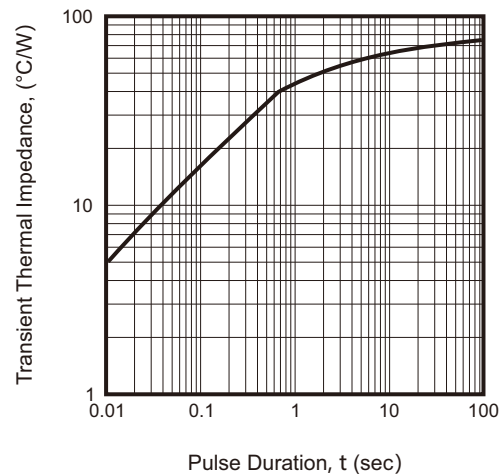
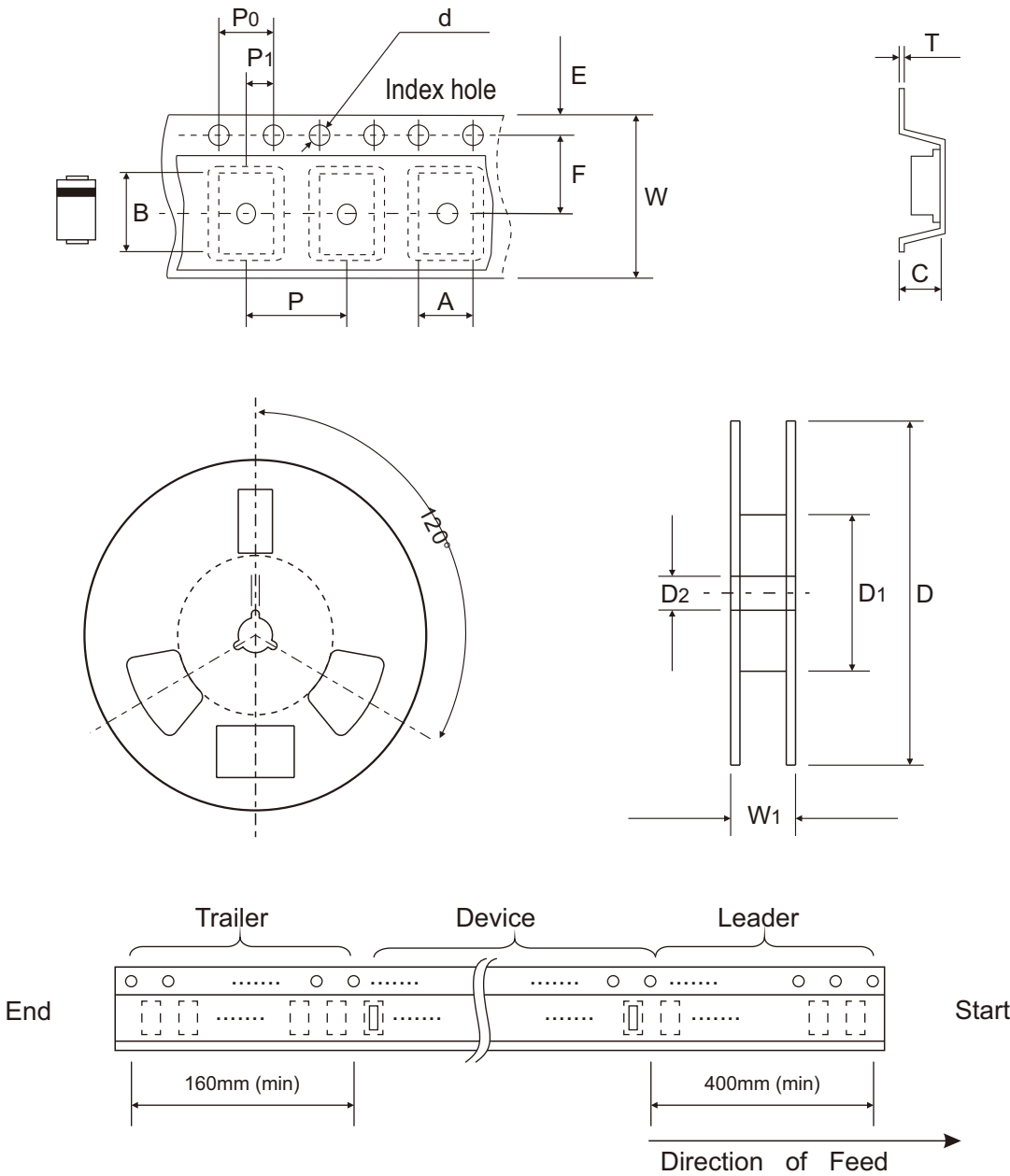

Fig.6 - Typical Transient Thermal Impedance



## Reel Taping Specification



SMBF	SYMBOL	A	B	C	d	D	D1	D2
	(mm)	3.80 ± 0.10	5.75 ± 0.10	1.40 ± 0.10	1.55 ± 0.05	330 ± 2.00	75 ± 1.00	13.00 ± 0.20
	(inch)	0.150 ± 0.004	0.226 ± 0.004	0.055 ± 0.004	0.061 ± 0.002	12.992 ± 0.079	2.953 ± 0.039	0.512 ± 0.008

SMBF	SYMBOL	E	F	P	P0	P1	T	W	W1
	(mm)	1.75 ± 0.10	5.50 ± 0.10	8.00 ± 0.10	4.00 ± 0.10	2.00 ± 0.05	0.23 ± 0.02	12.00 ± 0.10	14.70 + 2.00 - 1.00
	(inch)	0.069 ± 0.004	0.217 ± 0.004	0.315 ± 0.004	0.157 ± 0.004	0.079 ± 0.002	0.009 ± 0.001	0.472 ± 0.004	0.579 + 0.079 - 0.039

Company reserves the right to improve product design, functions and reliability without notice.

REV:A

## Marking Code

Part Number	Marking Code
SS24BF-HF	S24B
SS26BF-HF	S26B
SS210BF-HF	S210B
SS215BF-HF	S215B
SS220BF-HF	S220B

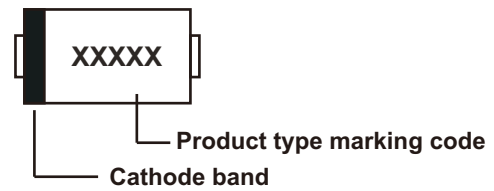

xxxx/xxxxx = Product type marking code

## Suggested PAD Layout

SIZE	SMBF	
	(mm)	(inch)
A	3.00	0.118
B	1.80	0.071
C	2.54	0.100
D	6.60	0.260

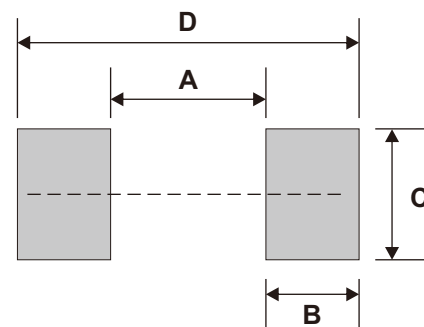

Note: 1. The pad layout is for reference purpose only.

## Standard Packaging

Case Type	REEL PACK	
	REEL ( pcs )	Reel Size (inch)
SMBF	5,000	13

# Mouser Electronics

Authorized Distributor

Click to View Pricing, Inventory, Delivery & Lifecycle Information:

[Comchip Technology:](#)

[SS210BF-HF](#) [SS24BF-HF](#) [SS215BF-HF](#) [SS26BF-HF](#) [SS220BF-HF](#)