

EMILY-D

~11° diffused spot beam. 14.74 mm high lens.

SPECIFICATION:

Dimensions	Ø 26.0 mm
Height	14.7 mm
Fastening	tape, pin
ROHS compliant	yes ⓘ

MATERIALS:

Component	Type	Material	Colour	Finish
EMILY-D	Single lens	PMMA	clear	
SPUTNIK-TAPE	Tape	Acrylic foam	black	

ORDERING INFORMATION:



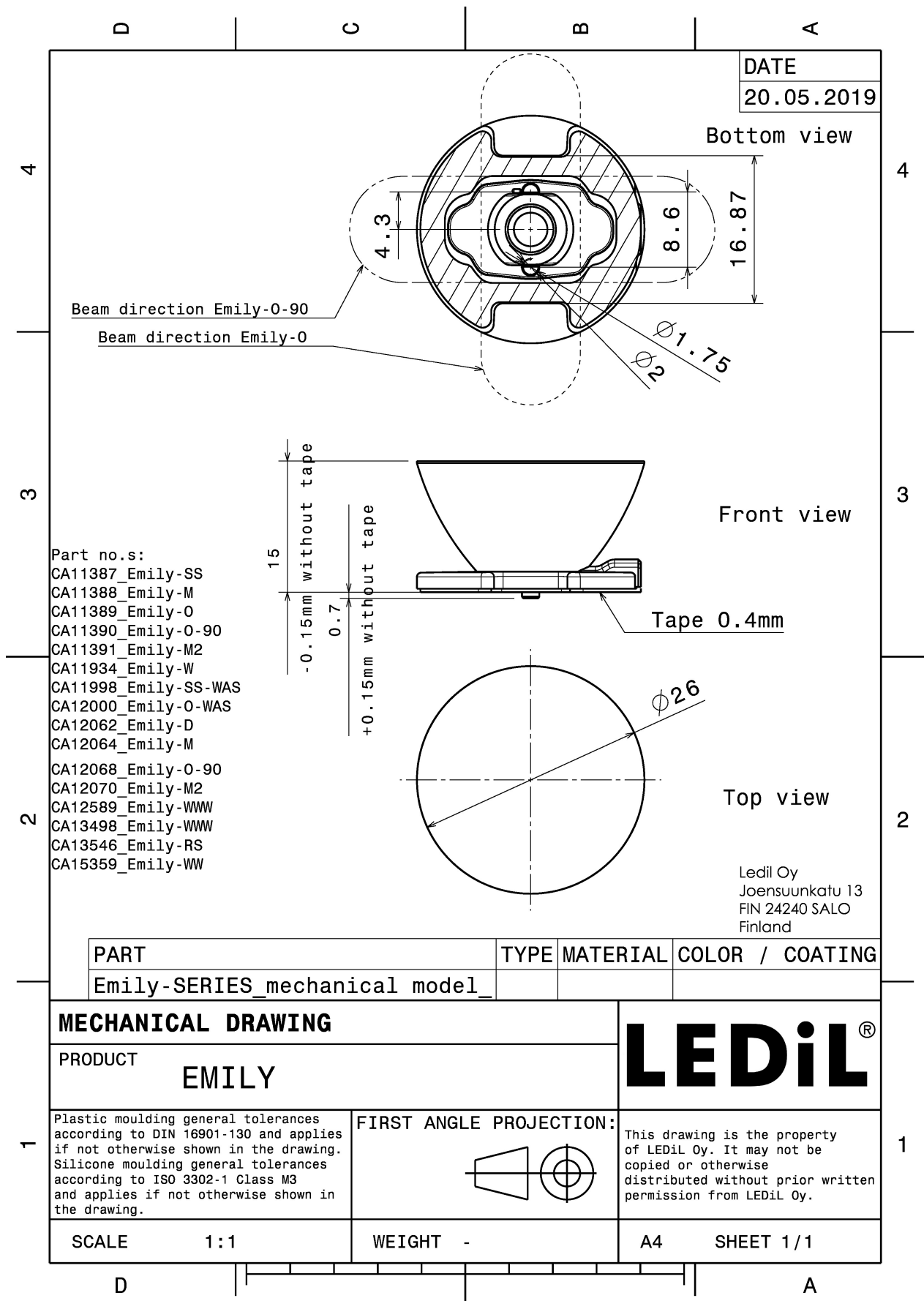

Component		Qty in box	MOQ	MPQ	Box weight (kg)
CA12062_EMILY-D	Single lens	1690	260	130	10.5
» Box size: 480 x 280 x 300 mm					



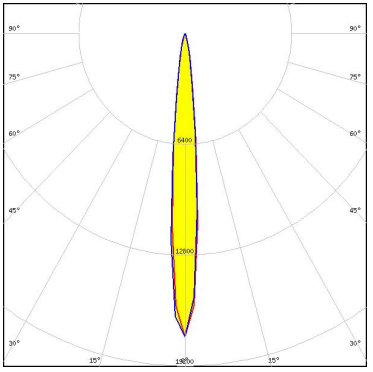

See also our general installation guide: www.ledil.com/installation_guide

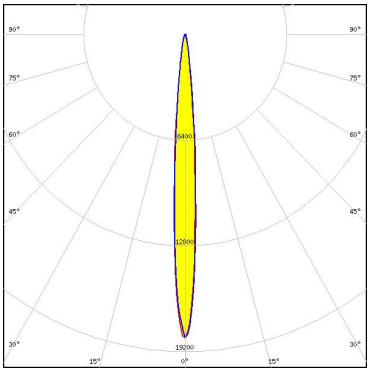
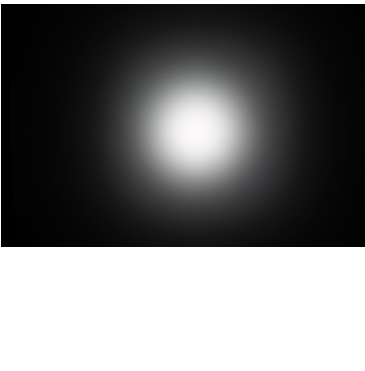
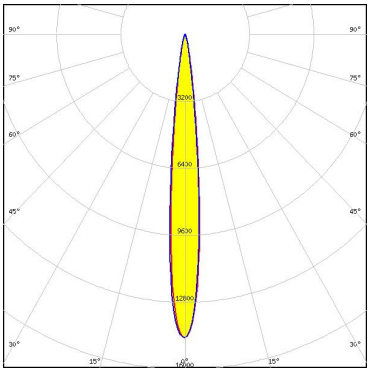
OPTICAL RESULTS (MEASURED):

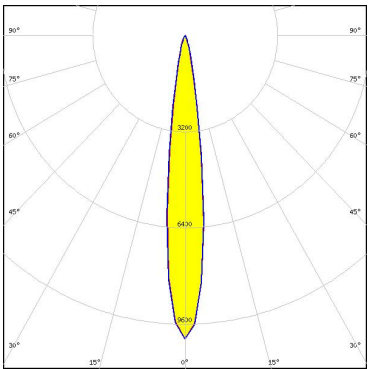
<p>CREE LEDs</p> <p>LED XB-H FWHM / FWTM 10.0° / 22.0° Efficiency 89 % Peak intensity 17.5 cd/lm LEDs/each optic 1 Light colour White Required components:</p>		
<p>CREE LEDs</p> <p>LED XD16 FWHM / FWTM 8.0° / 18.0° Efficiency 92 % Peak intensity 18.4 cd/lm LEDs/each optic 1 Light colour White Required components:</p>		
<p>CREE LEDs</p> <p>LED XHP35 HI FWHM / FWTM 11.0° / 22.0° Efficiency 92 % Peak intensity 14.5 cd/lm LEDs/each optic 1 Light colour White Required components:</p>		
<p>CREE LEDs</p> <p>LED XM-L FWHM / FWTM 14.0° / 27.0° Efficiency 90 % Peak intensity 10.1 cd/lm LEDs/each optic 1 Light colour White Required components:</p>		

OPTICAL RESULTS (MEASURED):



LED XM-L2
 FWHM / FWTM 14.0° / 27.0°
 Efficiency 90 %
 Peak intensity 10.2 cd/lm
 LEDs/each optic 1
 Light colour White
 Required components:

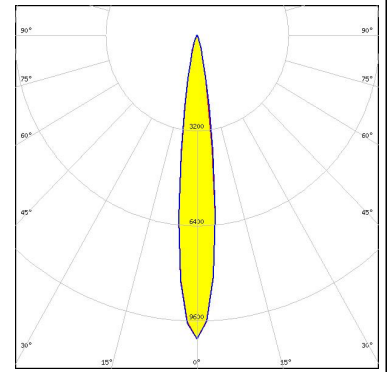

LED XP-E2
 FWHM / FWTM 8.0° / 18.0°
 Efficiency 87 %
 Peak intensity 27.3 cd/lm
 LEDs/each optic 1
 Light colour White
 Required components:

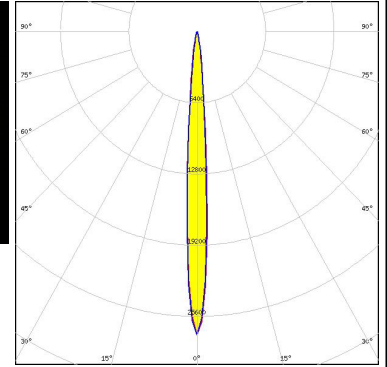

LED XP-G2
 FWHM / FWTM 10.0° / 20.0°
 Efficiency 90 %
 Peak intensity 20.8 cd/lm
 LEDs/each optic 1
 Light colour White
 Required components:

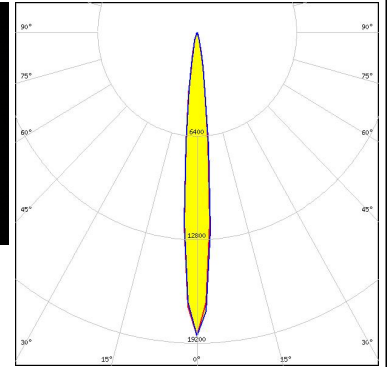

LED XP-G3
 FWHM / FWTM 11.0° / 24.0°
 Efficiency 94 %
 Peak intensity 13 cd/lm
 LEDs/each optic 1
 Light colour White
 Required components:

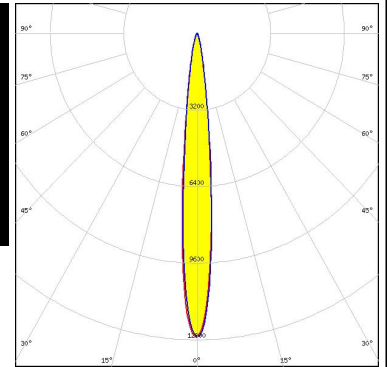

OPTICAL RESULTS (MEASURED):



LED XP-L HD
 FWHM / FWTM 13.0° / 26.0°
 Efficiency 90 %
 Peak intensity 10.2 cd/lm
 LEDs/each optic 1
 Light colour White
 Required components:

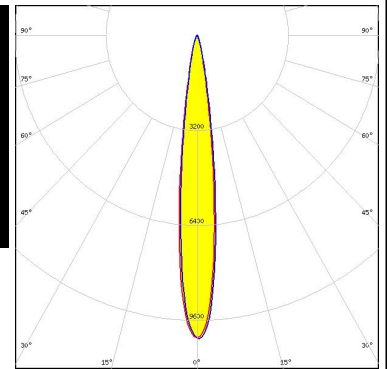
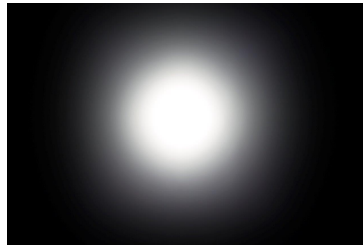

LED XP-L HI
 FWHM / FWTM 9.0° / 19.0°
 Efficiency 87 %
 Peak intensity 20 cd/lm
 LEDs/each optic 1
 Light colour White
 Required components:

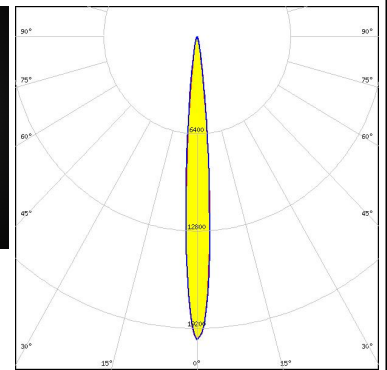





LED XT-E
 FWHM / FWTM 9.0°
 Efficiency %
 Peak intensity 14 cd/lm
 LEDs/each optic 1
 Light colour White
 Required components:

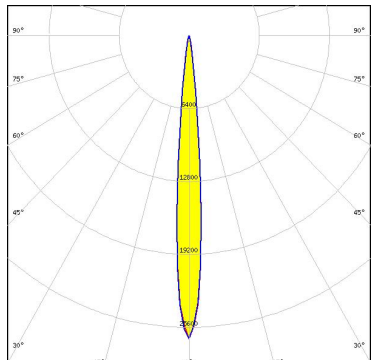

LED LUXEON A
 FWHM / FWTM 11.0°
 Efficiency 91 %
 LEDs/each optic 1
 Light colour White
 Required components:

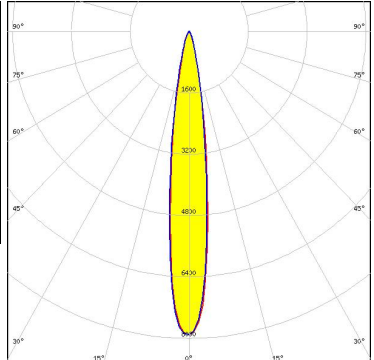
OPTICAL RESULTS (MEASURED):

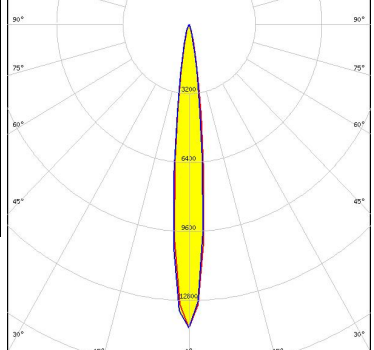
<p>LUMILEDS</p> <p>LED LUXEON Rebel ES</p> <p>FWHM / FWTM 10.0°</p> <p>Efficiency 91 %</p> <p>LEDs/each optic 1</p> <p>Light colour White</p> <p>Required components:</p>		
<p>NICHIA</p> <p>LED NS9x383</p> <p>FWHM / FWTM 14.0° / 30.0°</p> <p>Efficiency 90 %</p> <p>Peak intensity 7.9 cd/lm</p> <p>LEDs/each optic 1</p> <p>Light colour White</p> <p>Required components:</p>		
<p>OSRAM Opto Semiconductors</p> <p>LED OSLOM Square EC</p> <p>FWHM / FWTM 9.0° / 20.0°</p> <p>Efficiency 86 %</p> <p>Peak intensity 20.1 cd/lm</p> <p>LEDs/each optic 1</p> <p>Light colour White</p> <p>Required components:</p>		
<p>SAMSUNG</p> <p>LED LH351B</p> <p>FWHM / FWTM 12.0° / 25.0°</p> <p>Efficiency 88 %</p> <p>Peak intensity 14 cd/lm</p> <p>LEDs/each optic 1</p> <p>Light colour White</p> <p>Required components:</p>		

OPTICAL RESULTS (MEASURED):

SAMSUNG

LED LH351Z
 FWHM / FWTM 10.0° / 21.0°
 Efficiency 88 %
 Peak intensity 20 cd/lm
 LEDs/each optic 1
 Light colour White
 Required components:

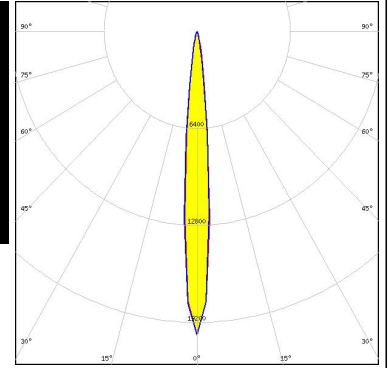

SEOUL SEMICONDUCTOR
 LED Z5M1/Z5M2
 FWHM / FWTM 10.0° / 20.0°
 Efficiency 94 %
 Peak intensity 18.2 cd/lm
 LEDs/each optic 1
 Light colour White
 Required components:

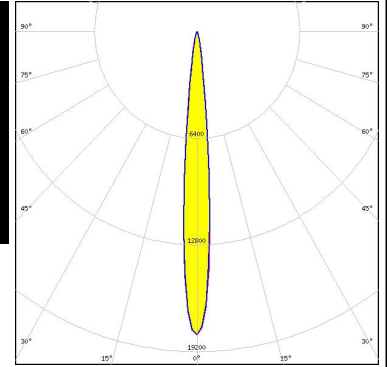

SEOUL SEMICONDUCTOR
 LED Z8Y22P
 FWHM / FWTM 11.0° / 24.0°
 Efficiency 93 %
 Peak intensity 11.3 cd/lm
 LEDs/each optic 1
 Light colour White
 Required components:

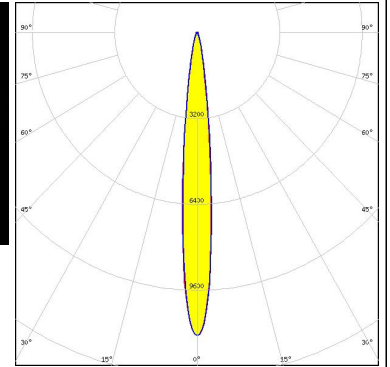

OPTICAL RESULTS (SIMULATED):



LED XHP35.2 HD
 FWHM / FWTM 16.0° / 30.0°
 Efficiency 93 %
 Peak intensity 8.2 cd/lm
 LEDs/each optic 1
 Light colour White
 Required components:

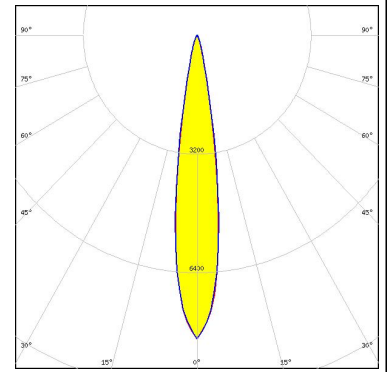

LED XM-L HVW
 FWHM / FWTM 14.0° / 27.0°
 Efficiency %
 LEDs/each optic 1
 Light colour White
 Required components:

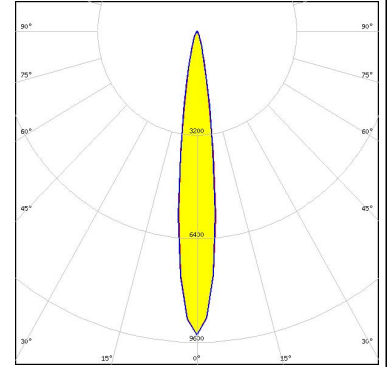

LED XP-G2 HE
 FWHM / FWTM 12.0° / 24.0°
 Efficiency 95 %
 Peak intensity 15.2 cd/lm
 LEDs/each optic 1
 Light colour White
 Required components:

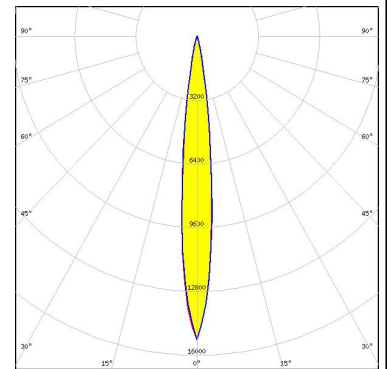

LED LUXEON C
 FWHM / FWTM 8.0° / 16.0°
 Efficiency 91 %
 Peak intensity 31.1 cd/lm
 LEDs/each optic 1
 Light colour White
 Required components:

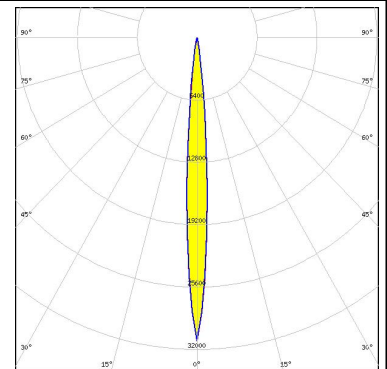

OPTICAL RESULTS (SIMULATED):

LUMILEDS

LED LUXEON HL2X
 FWHM / FWTM 12.0° / 24.0°
 Efficiency 96 %
 Peak intensity 14.7 cd/lm
 LEDs/each optic 1
 Light colour White
 Required components:

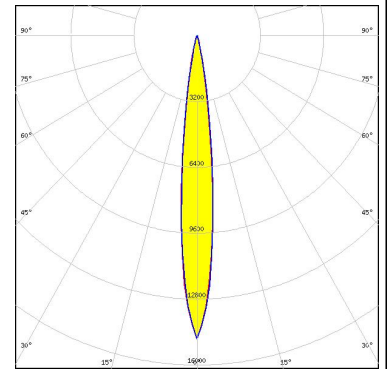

LUMILEDS

LED LUXEON HL2Z
 FWHM / FWTM 10.0° / 22.0°
 Efficiency 96 %
 Peak intensity 18.9 cd/lm
 LEDs/each optic 1
 Light colour White
 Required components:

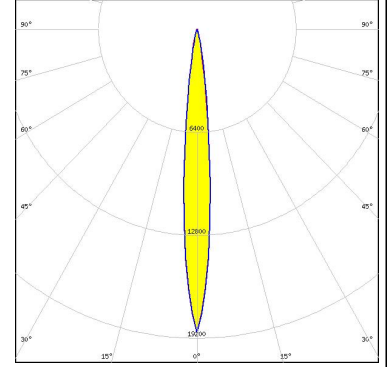

LUMILEDS

LED LUXEON MZ
 FWHM / FWTM 14.0° / 28.0°
 Efficiency 95 %
 Peak intensity 10.7 cd/lm
 LEDs/each optic 1
 Light colour White
 Required components:

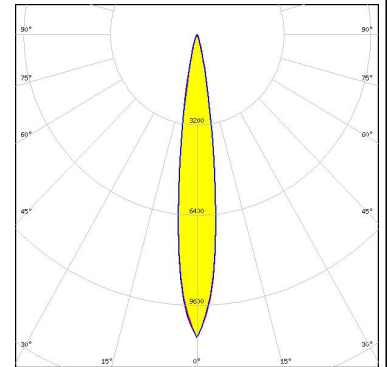





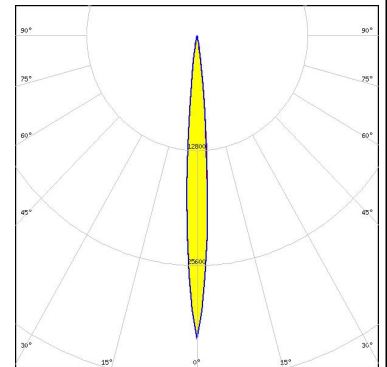

LUMILEDS

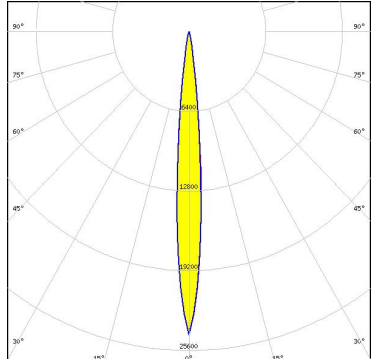
LED LUXEON SunPlus 20 Line (120 deg)
 FWHM / FWTM 8.0° / 16.0°
 Efficiency 95 %
 Peak intensity 33.8 cd/lm
 LEDs/each optic 1
 Light colour White
 Required components:

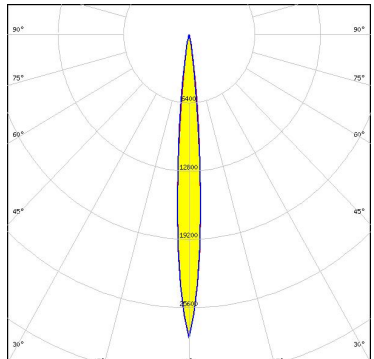

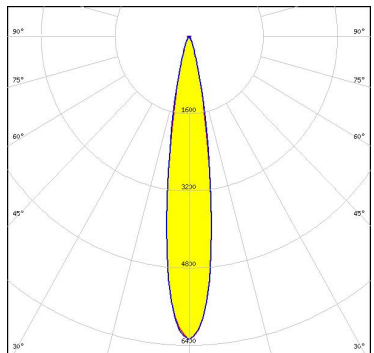
OPTICAL RESULTS (SIMULATED):

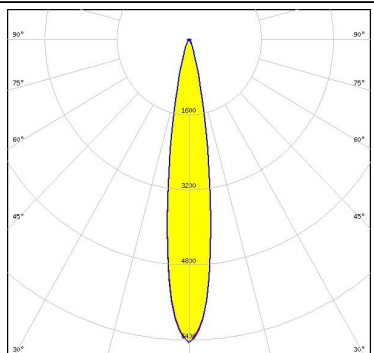
	<p>LED LUXEON TX FWHM / FWTM 10.0° / 18.0° Efficiency 95 % Peak intensity 24.3 cd/lm LEDs/each optic 1 Light colour White Required components:</p>	
	<p>LED LUXEON Z ES FWHM / FWTM 9.0° / 18.0° Efficiency 96 % Peak intensity 28.4 cd/lm LEDs/each optic 1 Light colour White Required components:</p>	
	<p>LED NCSxE17A FWHM / FWTM 16.0° / 34.0° Efficiency 89 % Peak intensity 6.3 cd/lm LEDs/each optic 4 Light colour White Required components:</p>	
	<p>LED NCSxE17A FWHM / FWTM 10.0° / 20.0° Efficiency 93 % Peak intensity 21.8 cd/lm LEDs/each optic 1 Light colour White Required components:</p>	

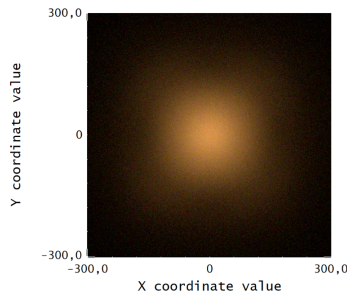

OPTICAL RESULTS (SIMULATED):

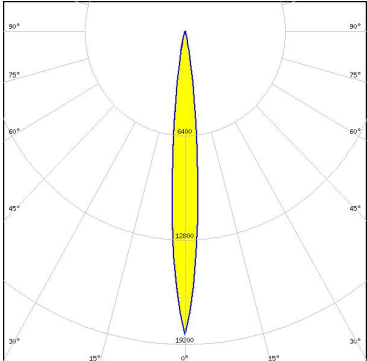
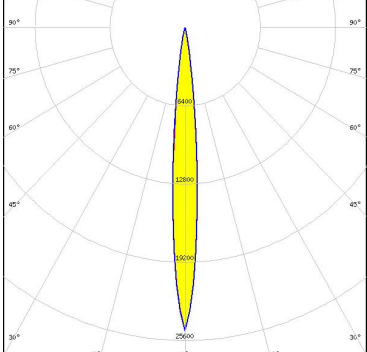
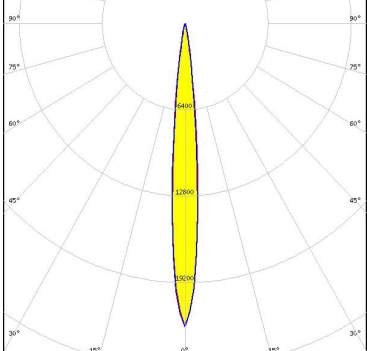
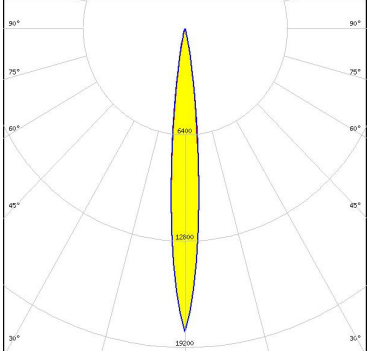
<p>NICHIA</p> <p>LED NVSxE21A FWHM / FWTM 10.0° / 22.0° Efficiency 94 % Peak intensity 18.6 cd/lm LEDs/each optic 1 Light colour White Required components:</p>	
<p>OSRAM Opto Semiconductors</p> <p>LED OSCONIQ C 2424 FWHM / FWTM 10.0° / 18.0° Efficiency 96 % Peak intensity 24.8 cd/lm LEDs/each optic 1 Light colour White Required components:</p>	
<p>OSRAM Opto Semiconductors</p> <p>LED OSOLON Square CSSRM2/CSSRM3 FWHM / FWTM 9.9° / 20.0° Efficiency 94 % Peak intensity 22.5 cd/lm LEDs/each optic 1 Light colour White Required components:</p>	
<p>OSRAM Opto Semiconductors</p> <p>LED SFH 4725AS FWHM / FWTM 11.0° / 22.0° Efficiency 95 % LEDs/each optic 1 Light colour IR Required components:</p>	

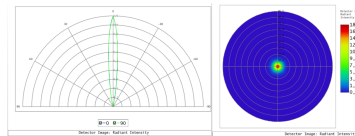

OPTICAL RESULTS (SIMULATED):



GENERAL INFORMATION:

NOTE: The typical beam angle will be changed by different color, chip size and chip position tolerance. The typical total beam angle is the full angle measured where the luminous intensity is half of the peak value.

MATERIALS:

As part of our continuous research and improvement processes, and to ensure the best possible quality and availability of our products, LEDiL reserves the right to change material grades without notice.

PRODUCT DATA USER AGREEMENT AND DISCLAIMER:

The measured data in the provided downloadable LEDiL Product Datasheets and Mechanical 2D-Drawings is rounded and provided as reference for planning. LEDiL Oy's optical specifications have been verified by conducting performance testing of the products in accordance with the company's quality system. The reported data are averaged results of multiple measurements with typical variation. LEDiL Oy reserves the right to without prior notification make changes and improvements to its products.

LEDiL Oy assumes neither warranty, nor guarantee nor any other liability of any kind for the contents and correctness of the provided data. The provided data has been generated with highest diligence but the provided data may in reality not represent the complete possible variation range of all intrinsic parameters. Therefore, in certain cases a deviation from the provided data could occur.

LEDiL Oy reserves the right to undertake technical changes of its products without further notification which could lead to changes in the provided data. LEDiL Oy assumes no liability of any kind for the possible deviation from any provided data or any other damage resulting from the usage of the provided data.

The user agrees to this disclaimer and user agreement with the download or usage of the provided files.

LEDiL Oy

Joensuunkatu 13
FI-24240 SALO
Finland

LEDiL Inc.

228 West Page Street
Suite D
Sycamore IL 60178
USA

Ledil Optics Technology (Shenzhen) Co., Ltd.

405 , Block B
Casic Motor Building
Shenzhen 518057
P.R.CHINA

Local sales and technical support

[www.ledil.com/
where_to_buy](http://www.ledil.com/where_to_buy)

Shipping locations

Salo, Finland
Hong Kong, China

Distribution Partners

[www.ledil.com/
where_to_buy](http://www.ledil.com/where_to_buy)

Mouser Electronics

Authorized Distributor

Click to View Pricing, Inventory, Delivery & Lifecycle Information:

Ledil:

[CA12062_EMILY-D](#)