

ILONA-SS

~14° smooth spot beam

SPECIFICATION:

Dimensions	Ø 49.8 mm
Height	29.3 mm
Fastening	socket
ROHS compliant	yes ⓘ

MATERIALS:

Component	Type	Material	Colour	Finish
ILONA-SS	Single lens	PMMA	clear	







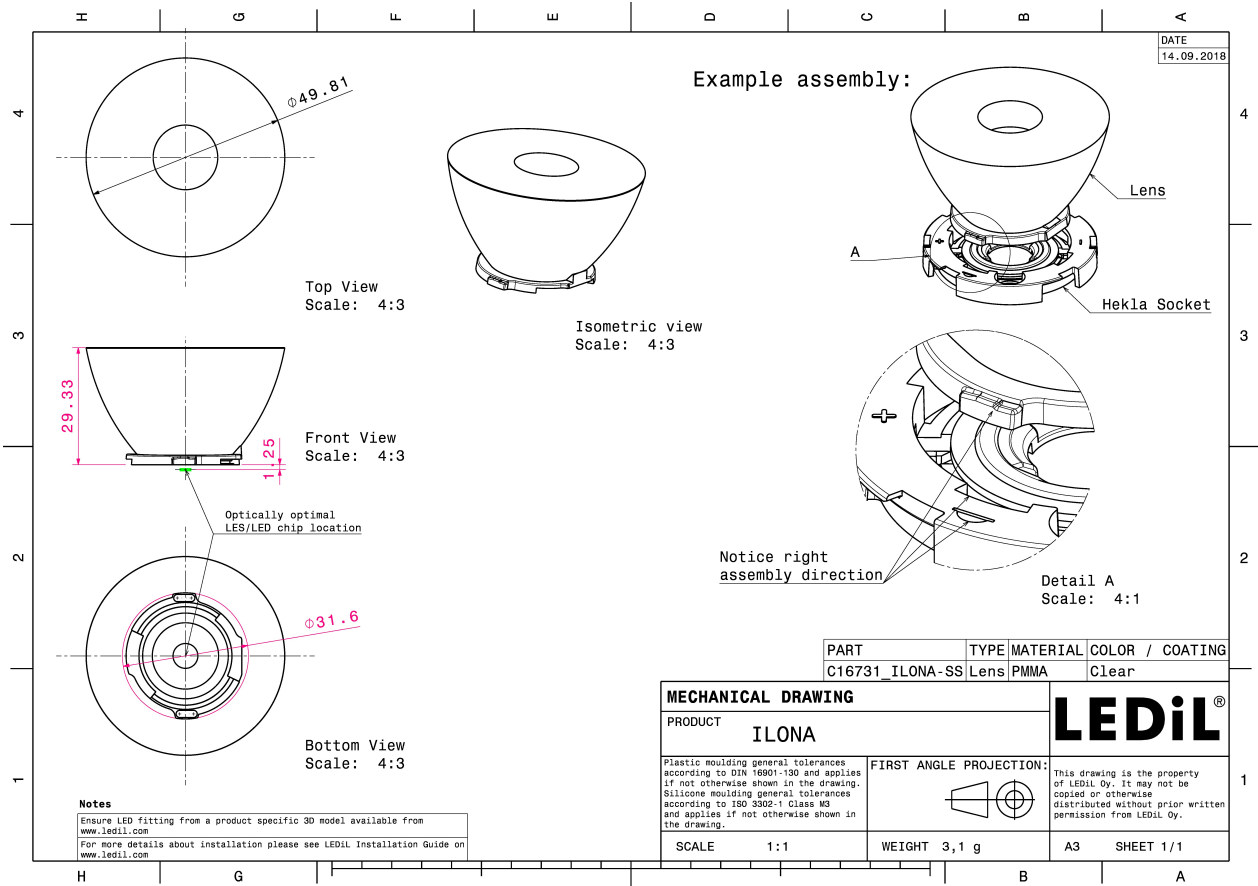



ORDERING INFORMATION:

Component	Qty in box	MOQ	MPQ	Box weight (kg)
C16731_ILONA-SS » Box size: 480 x 280 x 300 mm	264	99	33	9.7

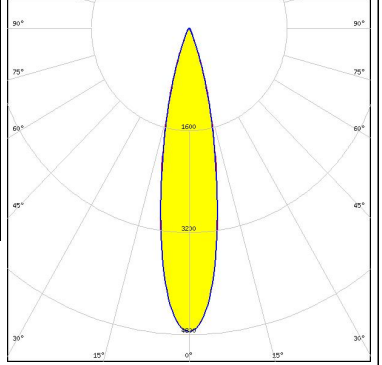

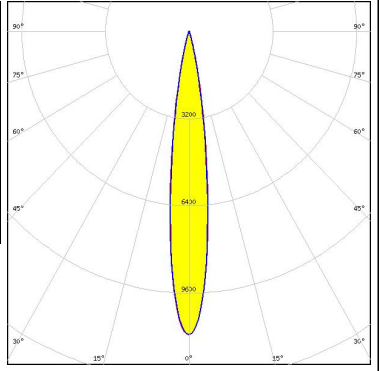
See also our general installation guide: www.ledil.com/installation_guide

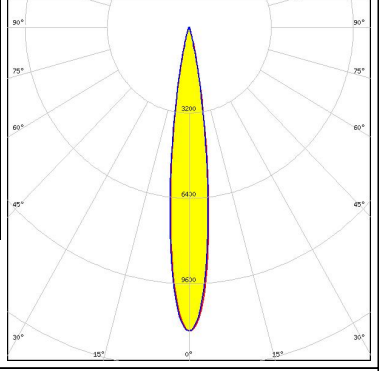
OPTICAL RESULTS (MEASURED):

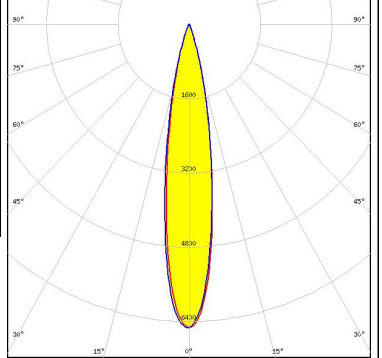
<p></p> <p>LED V11 HD Gen 8</p> <p>FWHM / FWTM 22.0° / 41.0°</p> <p>Efficiency 94 %</p> <p>Peak intensity 4.8 cd/lm</p> <p>LEDs/each optic 1</p> <p>Light colour White</p> <p>Required components: Bender Wirth: 633d Hekla</p>		
<p></p> <p>LED V6 HD Gen 7</p> <p>FWHM / FWTM 15.0° / 27.0°</p> <p>Efficiency 95 %</p> <p>Peak intensity 11.1 cd/lm</p> <p>LEDs/each optic 1</p> <p>Light colour White</p> <p>Required components: Bender Wirth: 634c Hekla</p>		
<p></p> <p>LED V6 HD Gen 7</p> <p>FWHM / FWTM 15.0° / 27.0°</p> <p>Efficiency 96 %</p> <p>Peak intensity 11.4 cd/lm</p> <p>LEDs/each optic 1</p> <p>Light colour White</p> <p>Required components: F15255_HEKLA-SOCKET-C</p>		
<p></p> <p>LED Vesta DTW 9mm (4W/6W/12W)</p> <p>FWHM / FWTM 18.0° / 36.0°</p> <p>Efficiency 93 %</p> <p>Peak intensity 6.5 cd/lm</p> <p>LEDs/each optic 1</p> <p>Light colour White</p> <p>Required components: C16142_HEKLA-SOCKET-K Bender Wirth: 490 Typ L8</p>		

OPTICAL RESULTS (MEASURED):



LED Vesta TW 6mm DP
 FWHM / FWTM 14.0° / 28.0°
 Efficiency 91 %
 Peak intensity 10.3 cd/lm
 LEDs/each optic 1
 Light colour White
 Required components:
 C16142_HEKLA-SOCKET-K
 Bender Wirth: 504 Typ L8

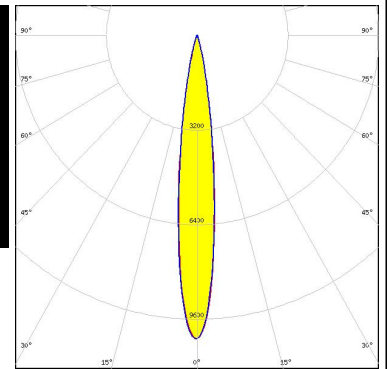

CITIZEN

LED CLU7A2/7A3
 FWHM / FWTM 11.0° / 21.0°
 Efficiency 94 %
 Peak intensity 18 cd/lm
 LEDs/each optic 1
 Light colour White
 Required components:
 F15255_HEKLA-SOCKET-C

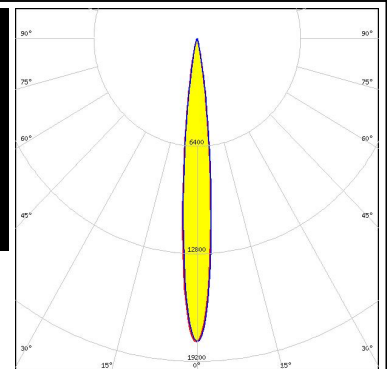

CITIZEN

LED CLU7B2
 FWHM / FWTM 10.0° / 20.0°
 Efficiency 94 %
 Peak intensity 19.7 cd/lm
 LEDs/each optic 1
 Light colour White
 Required components:
 F15255_HEKLA-SOCKET-C

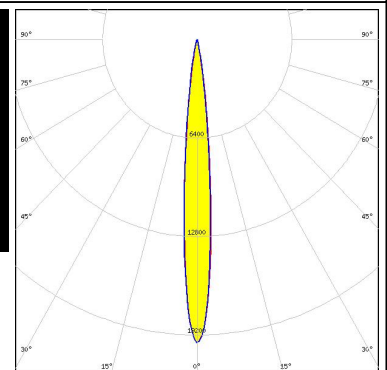
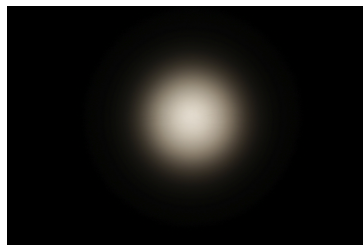

LED LUXEON CX Plus CoB L08 (Gen2)
 FWHM / FWTM 26.0° / 52.0°
 Efficiency 93 %
 Peak intensity 3 cd/lm
 LEDs/each optic 1
 Light colour White
 Required components:
 Bender Wirth: 637a Hekla

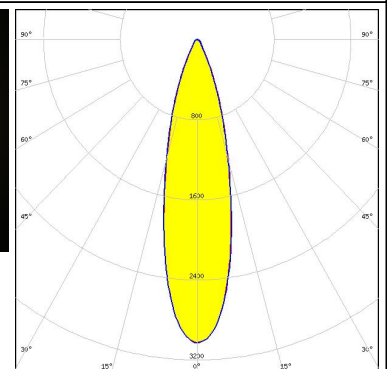
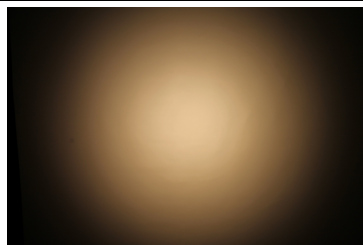

OPTICAL RESULTS (MEASURED):

LUMILEDS

LED LUXEON CX Plus CoB - HD S01H4
 FWHM / FWTM 13.0° / 25.0°
 Efficiency 95 %
 Peak intensity 13.2 cd/lm
 LEDs/each optic 1
 Light colour White
 Required components:
 Bender Wirth: 634c Hekla

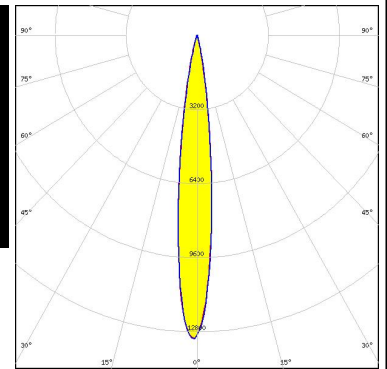

LUMILEDS

LED LUXEON CX Plus CoB - HD S02H6
 FWHM / FWTM 14.0° / 27.0°
 Efficiency 94 %
 Peak intensity 11.7 cd/lm
 LEDs/each optic 1
 Light colour White
 Required components:
 Bender Wirth: 634c Hekla

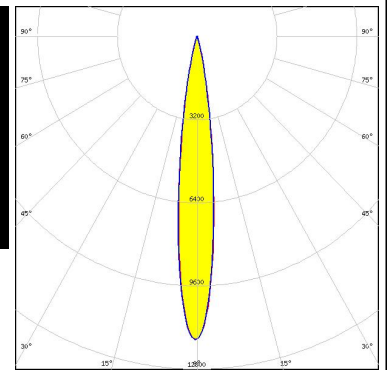
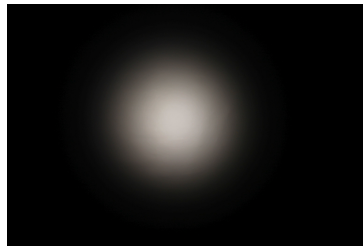

LUMILEDS

LED LUXEON CX Plus CoB - HD S04H9
 FWHM / FWTM 19.0° / 35.0°
 Efficiency 94 %
 Peak intensity 6.8 cd/lm
 LEDs/each optic 1
 Light colour White
 Required components:
 Bender Wirth: 634c Hekla

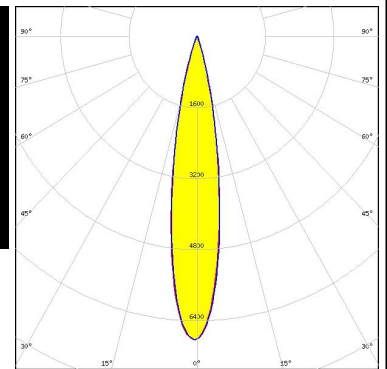

LUMILEDS

LED LUXEON CX Plus CoB L04 / L05 (Gen2)
 FWHM / FWTM 22.0° / 43.0°
 Efficiency 94 %
 Peak intensity 4.6 cd/lm
 LEDs/each optic 1
 Light colour White
 Required components:
 Bender Wirth: 637a Hekla

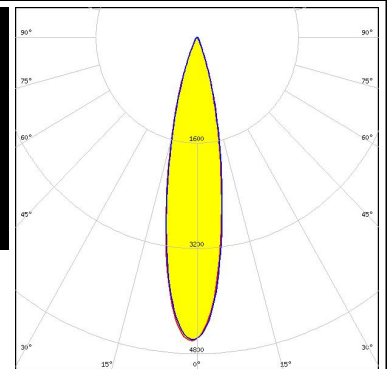
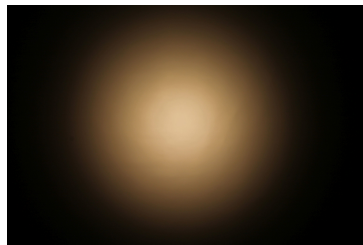

OPTICAL RESULTS (MEASURED):

LUMILEDS

LED LUXEON CX Plus CoB M02 / M03 (Gen2)
 FWHM / FWTM 17.0° / 33.0°
 Efficiency 94 %
 Peak intensity 7.6 cd/lm
 LEDs/each optic 1
 Light colour White
 Required components:
 Bender Wirth: 641a Hekla

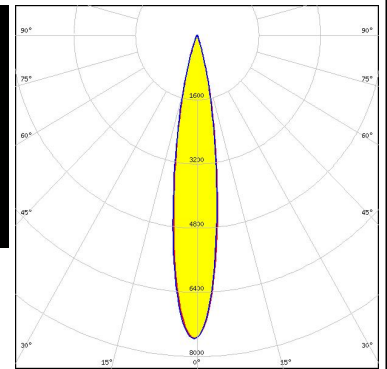

LUMILEDS

LED LUXEON CX Plus CoB S01 (Gen2)
 FWHM / FWTM 13.0° / 26.0°
 Efficiency 94 %
 Peak intensity 12.3 cd/lm
 LEDs/each optic 1
 Light colour White
 Required components:
 Bender Wirth: 634c Hekla

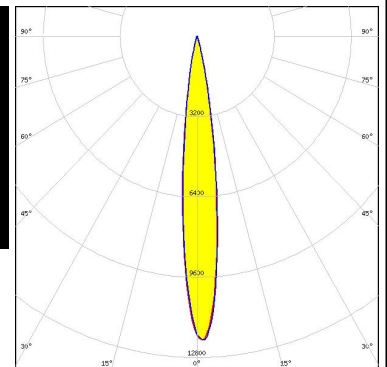

LUMINUS

LED CXM-3
 FWHM / FWTM 11.0° / 20.0°
 Efficiency 94 %
 Peak intensity 20.2 cd/lm
 LEDs/each optic 1
 Light colour White
 Required components:
 F15255_HEKLA-SOCKET-C

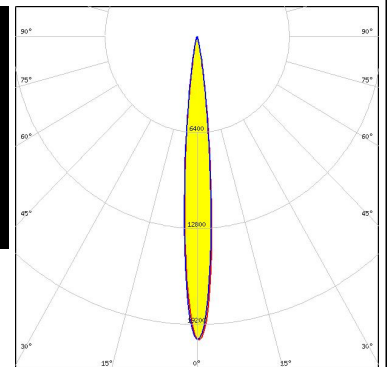

LUMINUS

LED CXM-4
 FWHM / FWTM 12.0° / 23.0°
 Efficiency 94 %
 Peak intensity 15.8 cd/lm
 LEDs/each optic 1
 Light colour White
 Required components:
 F15255_HEKLA-SOCKET-C

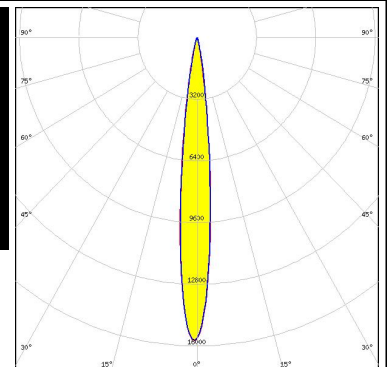
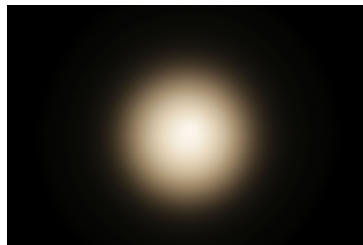

OPTICAL RESULTS (MEASURED):

OSRAM

Opto Semiconductors

LED OSTAR Stage (S2WN)
 FWHM / FWTM 10.0° / 19.0°
 Efficiency 94 %
 Peak intensity 22.9 cd/lm
 LEDs/each optic 1
 Light colour White
 Required components:
 F15859_HEKLA-SOCKET-I

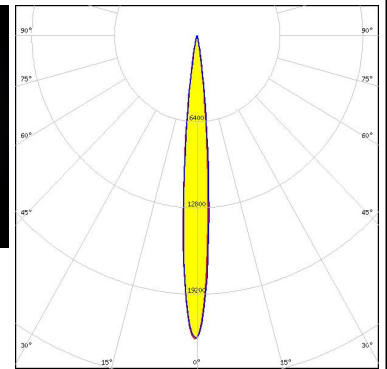
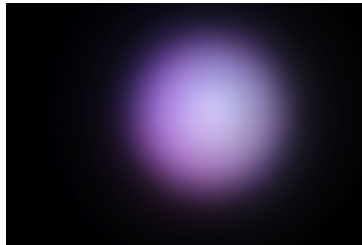

OSRAM

Opto Semiconductors

LED OSTAR Stage (S2WP)
 FWHM / FWTM 11.0° / 21.0°
 Efficiency 94 %
 Peak intensity 18.6 cd/lm
 LEDs/each optic 1
 Light colour White
 Required components:
 F15859_HEKLA-SOCKET-I

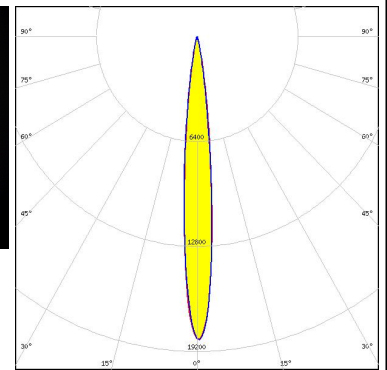
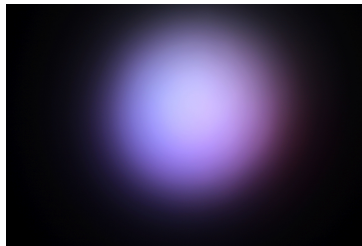

SAMSUNG

LED LC010T (Tunable White)
 FWHM / FWTM 18.0° / 37.0°
 Efficiency 94 %
 Peak intensity 6.1 cd/lm
 LEDs/each optic 1
 Light colour Tunable White
 Required components:
 C16142_HEKLA-SOCKET-K
 Bender Wirth: 501 Typ L8

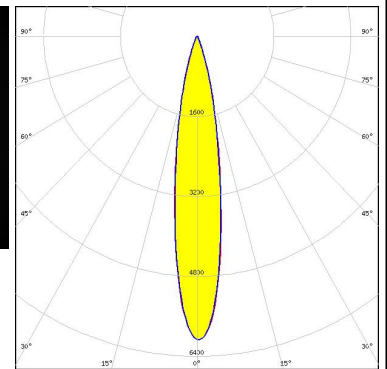
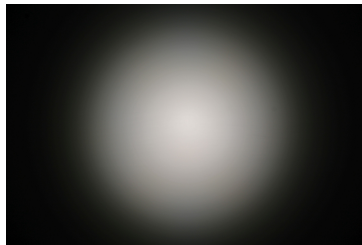





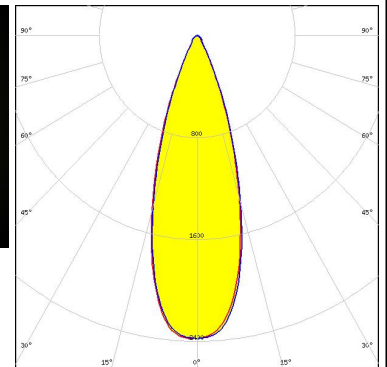
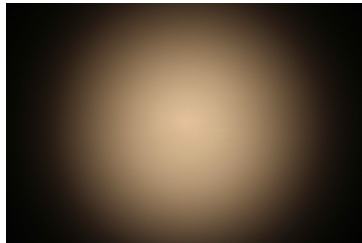

SEOUL SEMICONDUCTOR

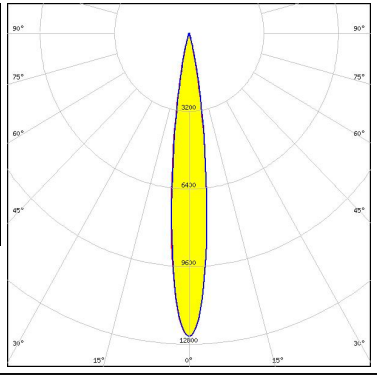
LED MJT COB LES 14.5
 FWHM / FWTM 33.0° / 57.0°
 Efficiency 95 %
 Peak intensity 2.4 cd/lm
 LEDs/each optic 1
 Light colour White
 Required components:
 F17438_HEKLA-G2-I

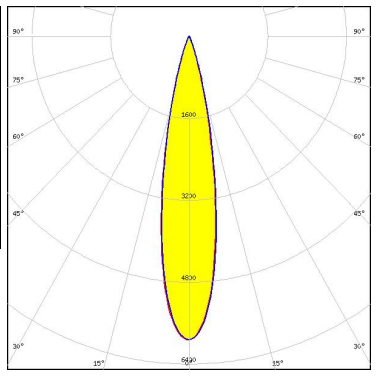

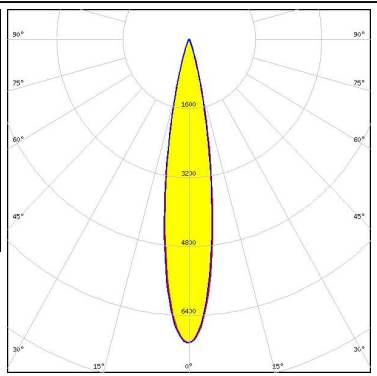
OPTICAL RESULTS (MEASURED):

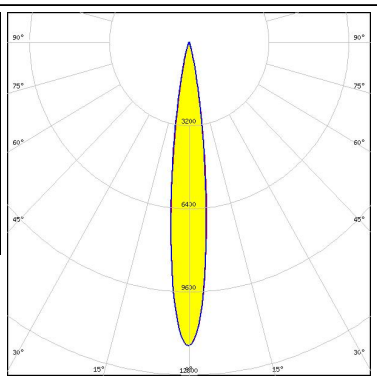
<p>SEOL SEOUL SEMICONDUCTOR</p> <p>LED MJT COB LES 6 FWHM / FWTM 14.0° / 26.0° Efficiency 96 % Peak intensity 12.5 cd/lm LEDs/each optic 1 Light colour White Required components: F17435_HEKLA-G2-C</p>		
<p>SEOL SEOUL SEMICONDUCTOR</p> <p>LED MJT COB LES 9.8 FWHM / FWTM 21.0° / 37.0° Efficiency 96 % Peak intensity 5.9 cd/lm LEDs/each optic 1 Light colour White Required components: F17435_HEKLA-G2-C</p>		
<p>TRIDONIC</p> <p>LED SLE G7 LES09 FWHM / FWTM 18.0° / 34.0° Efficiency 95 % Peak intensity 7 cd/lm LEDs/each optic 1 Light colour White Required components: F15255_HEKLA-SOCKET-C</p>		
<p>XICATO</p> <p>LED XOB 6 mm FWHM / FWTM 14.0° / 26.0° Efficiency 94 % Peak intensity 11.7 cd/lm LEDs/each optic 1 Light colour White Required components: F15255_HEKLA-SOCKET-C</p>		





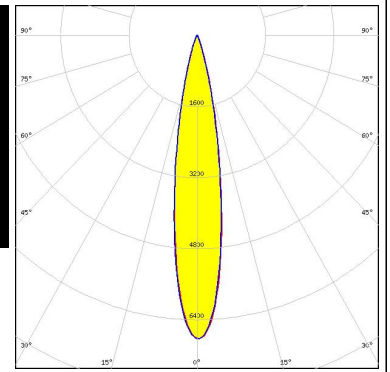

OPTICAL RESULTS (MEASURED):

XICATO

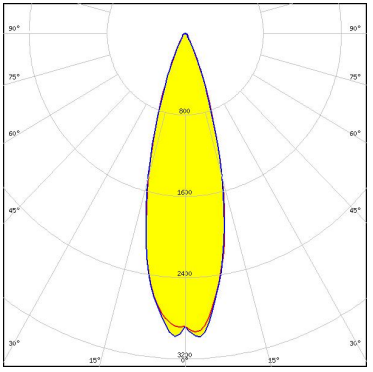

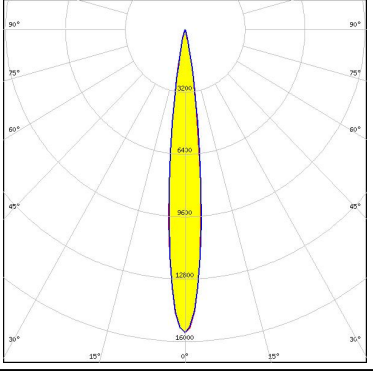
LED	XOB 9.8 mm
FWHM / FWTM	19.0° / 35.0°
Efficiency	94 %
Peak intensity	6.8 cd/lm
LEDs/each optic	1
Light colour	White
Required components:	
	F15255_HEKLA-SOCKET-C

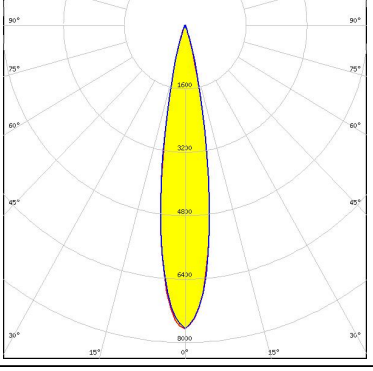

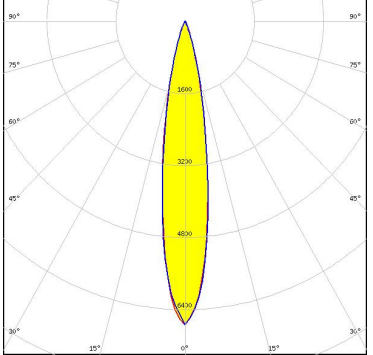
OPTICAL RESULTS (SIMULATED):

<p></p> <p>LED V13 Gen 8 FWHM / FWTM 30.0° / 52.0° Efficiency 92 % Peak intensity 3 cd/lm LEDs/each optic 1 Light colour White Required components: F15859_HEKLA-SOCKET-I</p>	
<p></p> <p>LED V4 HD Gen 7 FWHM / FWTM 12.0° / 23.0° Efficiency 91 % Peak intensity 15.6 cd/lm LEDs/each optic 1 Light colour White Required components: F15253_HEKLA-SOCKET-A</p>	
<p></p> <p>LED V9 HD Gen7 FWHM / FWTM 18.0° / 32.0° Efficiency 94 % Peak intensity 7.7 cd/lm LEDs/each optic 1 Light colour White Required components: F15859_HEKLA-SOCKET-I</p>	
<p></p> <p>LED Vero SE 10 FWHM / FWTM 18.0° / 36.0° Efficiency 94 % Peak intensity 6.7 cd/lm LEDs/each optic 1 Light colour White Required components:</p>	

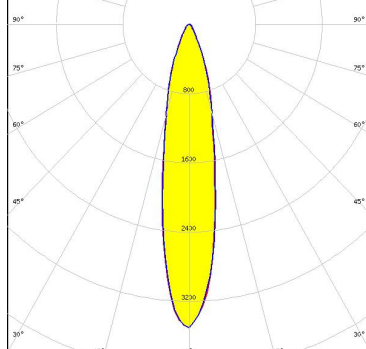
OPTICAL RESULTS (SIMULATED):

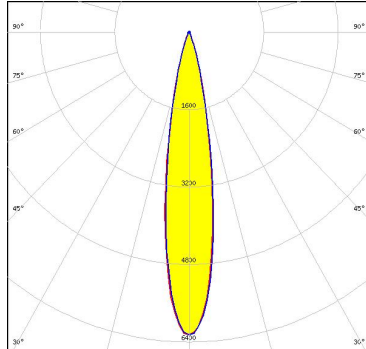
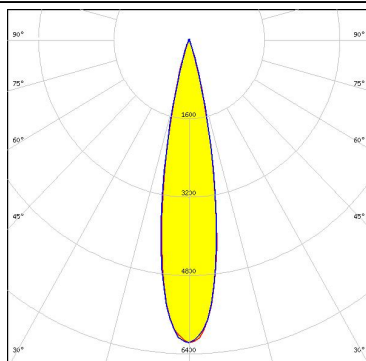
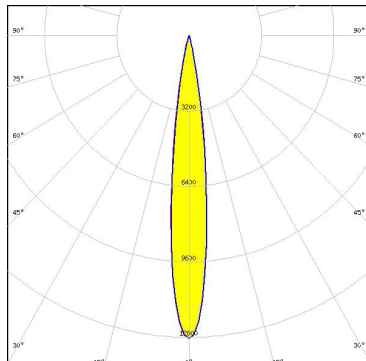
<p></p> <p>LED: Vero SE 13 FWHM / FWTM: 20.0° / 50.0° Efficiency: 91 % Peak intensity: 3.5 cd/lm LEDs/each optic: 1 Light colour: White Required components: C16142_HEKLA-SOCKET-K</p>	
<p></p> <p>LED: Vesta TW 9mm (9W) DP FWHM / FWTM: 18.0° / 35.0° Efficiency: 86 % Peak intensity: 6.3 cd/lm LEDs/each optic: 1 Light colour: White Required components: C16142_HEKLA-SOCKET-K Bender Wirth: 489 Typ L8</p>	
<p>CITIZEN</p> <p>LED: CLL02x/CLU02x (LES10) FWHM / FWTM: 21.0° / 35.0° Efficiency: 87 % Peak intensity: 6.2 cd/lm LEDs/each optic: 1 Light colour: White Required components: F15255_HEKLA-SOCKET-C</p>	
<p>CITIZEN</p> <p>LED: CLU700/701/702/703 FWHM / FWTM: 14.0° / 25.0° Efficiency: 91 % Peak intensity: 12.9 cd/lm LEDs/each optic: 1 Light colour: White Required components: F15255_HEKLA-SOCKET-C</p>	

OPTICAL RESULTS (SIMULATED):

CITIZEN

LED CLU712/713
 FWHM / FWTM 18.0° / 33.0°
 Efficiency 95 %
 Peak intensity 7.6 cd/lm
 LEDs/each optic 1
 Light colour White
 Required components:
 F17438_HEKLA-G2-I

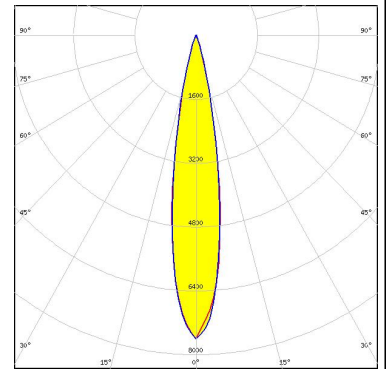

LED CHA0304
 FWHM / FWTM 11.0° / 22.0°
 Efficiency 95 %
 Peak intensity 18.1 cd/lm
 LEDs/each optic 1
 Light colour White
 Required components:
 F17435_HEKLA-G2-C

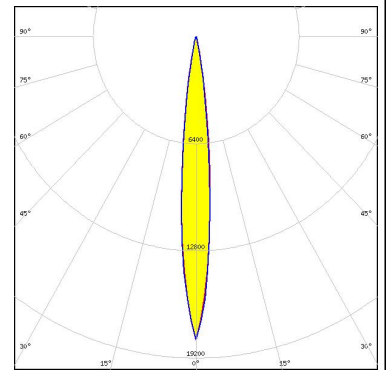

LED CHA0410
 FWHM / FWTM 12.0° / 24.0°
 Efficiency 95 %
 Peak intensity 15.1 cd/lm
 LEDs/each optic 1
 Light colour White
 Required components:
 F17435_HEKLA-G2-C

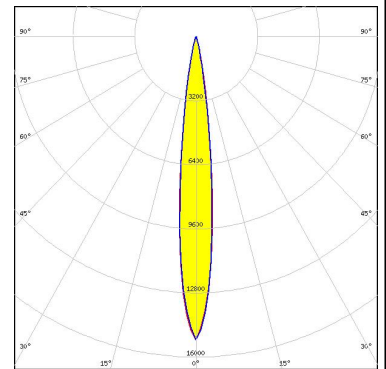

LED CMA1303
 FWHM / FWTM 12.0° / 24.0°
 Efficiency 96 %
 Peak intensity 16 cd/lm
 LEDs/each optic 1
 Light colour White
 Required components:
 F17439_HEKLA-G2-J

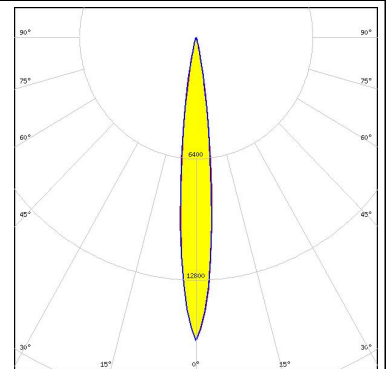

OPTICAL RESULTS (SIMULATED):

<p>LED ENGIN</p> <p>LED LZ4-00XX08 FWHM / FWTM 12.0° / 23.0° Efficiency 96 % LEDs/each optic 1 Light colour IR Required components: F15255_HEKLA-SOCKET-C</p>	
<p>LED ENGIN</p> <p>LED LZ4-00XX08 FWHM / FWTM 10.0° / 22.0° Efficiency 95 % Peak intensity 19.7 cd/lm LEDs/each optic 1 Light colour White Required components: F15255_HEKLA-SOCKET-C</p>	
<p>LUMILEDS</p> <p>LED LUXEON CoB 1202/1203 FWHM / FWTM 19.0° / 35.0° Efficiency 93 % Peak intensity 6.8 cd/lm LEDs/each optic 1 Light colour White Required components: F17437_HEKLA-G2-H</p>	
<p>LUMILEDS</p> <p>LED LUXEON CoB 1202s FWHM / FWTM 14.0° / 26.0° Efficiency 96 % Peak intensity 12.1 cd/lm LEDs/each optic 1 Light colour White Required components: F15858_HEKLA-SOCKET-H</p>	

OPTICAL RESULTS (SIMULATED):

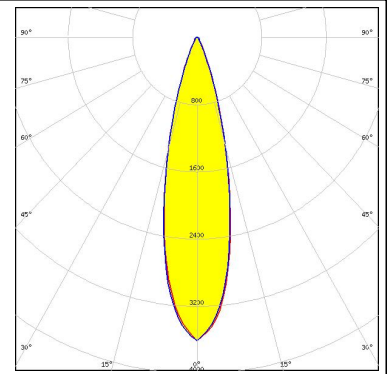
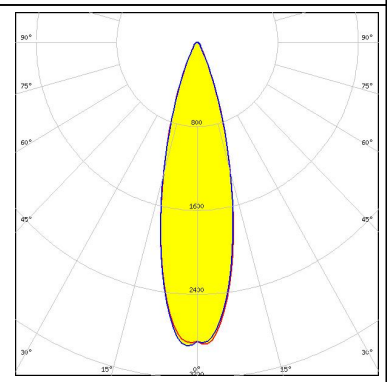
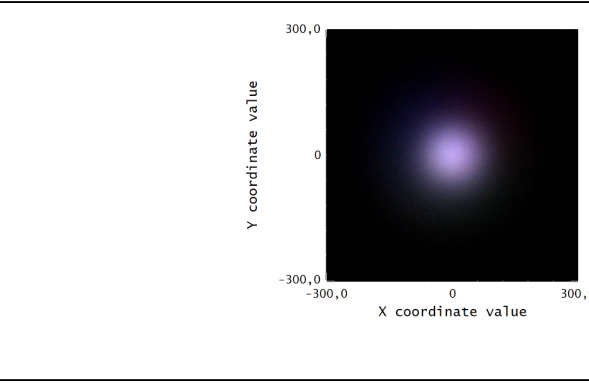
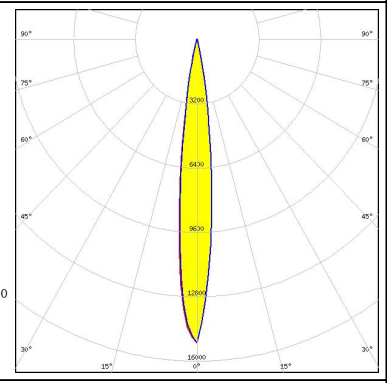
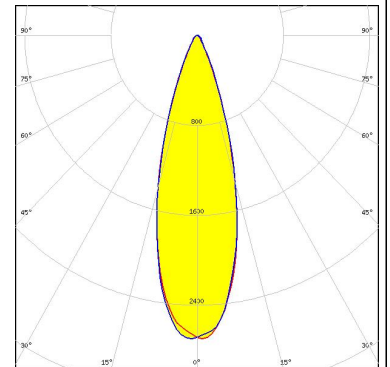
<p>LUMILEDS</p> <p>LED LUXEON CoB 1204/1205</p> <p>FWHM / FWTM 26.0° / 47.0°</p> <p>Efficiency 93 %</p> <p>Peak intensity 3.6 cd/lm</p> <p>LEDs/each optic 1</p> <p>Light colour White</p> <p>Required components:</p>		
<p>LUMILEDS</p> <p>LED LUXEON CoB 1208</p> <p>FWHM / FWTM 28.0° / 52.0°</p> <p>Efficiency 90 %</p> <p>Peak intensity 2.9 cd/lm</p> <p>LEDs/each optic 1</p> <p>Light colour White</p> <p>Required components:</p>		
<p>LUMILEDS</p> <p>LED LUXEON Rubix</p> <p>FWHM / FWTM 13.0° / 24.0°</p> <p>Efficiency 95 %</p> <p>Peak intensity 15.1 cd/lm</p> <p>LEDs/each optic 4</p> <p>Light colour RGBW</p> <p>Required components:</p>		
<p>LUMINUS</p> <p>LED CxM-14 (18.5x18.5)</p> <p>FWHM / FWTM 30.0° / 54.0°</p> <p>Efficiency 93 %</p> <p>Peak intensity 2.7 cd/lm</p> <p>LEDs/each optic 1</p> <p>Light colour White</p> <p>Required components: F17438_HEKLA-G2-I</p>		

OPTICAL RESULTS (SIMULATED):

<p>NICHIA</p> <p>LED COB S-Type (LES 6)</p> <p>FWHM / FWTM 14.0° / 26.0°</p> <p>Efficiency 93 %</p> <p>Peak intensity 12.1 cd/lm</p> <p>LEDs/each optic 1</p> <p>Light colour White</p> <p>Required components: F15848_HEKLA-SOCKET-G</p>	
<p>NICHIA</p> <p>LED COB S-Type (LES 6)</p> <p>FWHM / FWTM 14.0° / 26.0°</p> <p>Efficiency 93 %</p> <p>Peak intensity 12.2 cd/lm</p> <p>LEDs/each optic 1</p> <p>Light colour White</p> <p>Required components: F15848_HEKLA-SOCKET-G</p>	
<p>NICHIA</p> <p>LED COB S-Type (LES 7)</p> <p>FWHM / FWTM 16.0° / 30.0°</p> <p>Efficiency 95 %</p> <p>Peak intensity 10.2 cd/lm</p> <p>LEDs/each optic 1</p> <p>Light colour White</p> <p>Required components: F15848_HEKLA-SOCKET-G</p>	
<p>NICHIA</p> <p>LED NFSWE11A</p> <p>FWHM / FWTM 18.0° / 32.0°</p> <p>Efficiency 88 %</p> <p>Peak intensity 7.5 cd/lm</p> <p>LEDs/each optic 30</p> <p>Light colour White</p> <p>Required components: C16142_HEKLA-SOCKET-K</p>	

OPTICAL RESULTS (SIMULATED):

<p>NICHIA</p> <p>LED NJCWL024Z-V1MT: COB L-Type Tunable White</p> <p>FWHM / FWTM 16.0° / 30.0°</p> <p>Efficiency 94 %</p> <p>Peak intensity 9.7 cd/lm</p> <p>LEDs/each optic 1</p> <p>Light colour White</p> <p>Required components: C16142_HEKLA-SOCKET-K Bender Wirth: 497 Typ L8</p>	
<p>NICHIA</p> <p>LED NVCWJ024Z-V1MT: COB J-Type Tunable White</p> <p>FWHM / FWTM 20.0° / 40.0°</p> <p>Efficiency 93 %</p> <p>Peak intensity 5.3 cd/lm</p> <p>LEDs/each optic 1</p> <p>Light colour White</p> <p>Required components: C16142_HEKLA-SOCKET-K Bender Wirth: 498 Typ L8</p>	
<p>PHILIPS</p> <p>LED Fortimo SLM L13 CoB</p> <p>FWHM / FWTM 24.0° / 46.0°</p> <p>Efficiency 93 %</p> <p>Peak intensity 3.9 cd/lm</p> <p>LEDs/each optic 1</p> <p>Light colour White</p> <p>Required components: Bender Wirth: 632a Hekla XL</p>	
<p>PHILIPS</p> <p>LED Fortimo SLM L15 CoB</p> <p>FWHM / FWTM 26.0° / 51.0°</p> <p>Efficiency 92 %</p> <p>Peak intensity 3.2 cd/lm</p> <p>LEDs/each optic 1</p> <p>Light colour White</p> <p>Required components: Bender Wirth: 632a Hekla XL</p>	

OPTICAL RESULTS (SIMULATED):

SAMSUNG

LED LC003D / LC006D / LC009D / LC013D
 FWHM / FWTM 19.0° / 34.0°
 Efficiency 87 %
 Peak intensity 6.6 cd/lm
 LEDs/each optic 1
 Light colour White
 Required components:
 F15255_HEKLA-SOCKET-C

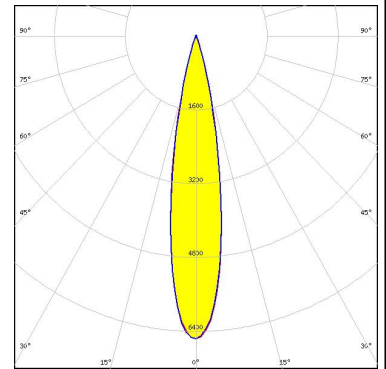

SAMSUNG

LED LC020C
 FWHM / FWTM 14.0° / 28.0°
 Efficiency 94 %
 Peak intensity 11.4 cd/lm
 LEDs/each optic 1
 Light colour White
 Required components:
 F17438_HEKLA-G2-I

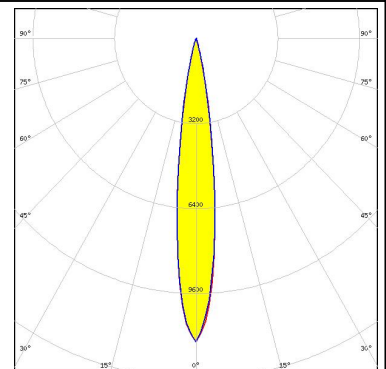

SAMSUNG

LED LC020T (Tunable white)
 FWHM / FWTM 22.0° / 42.0°
 Efficiency 92 %
 Peak intensity 4.6 cd/lm
 LEDs/each optic 1
 Light colour White
 Required components:
 C16142_HEKLA-SOCKET-K
 Bender Wirth: 501 Typ L8

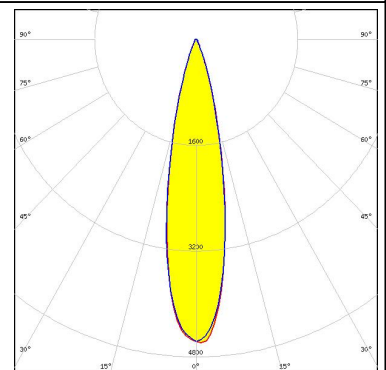

XICATO

LED XTM - 9mm LES
 FWHM / FWTM 18.0° / 34.0°
 Efficiency 94 %
 Peak intensity 7.5 cd/lm
 LEDs/each optic 1
 Light colour White
 Required components:
 C15743_XTM-ADAPTER-50-B

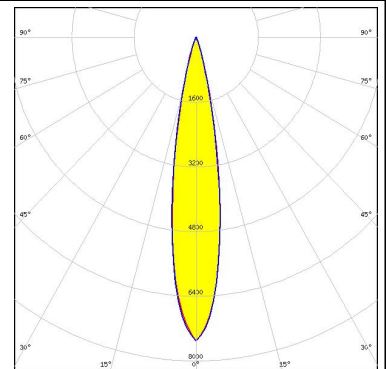

GENERAL INFORMATION:

NOTE: The typical beam angle will be changed by different color, chip size and chip position tolerance. The typical total beam angle is the full angle measured where the luminous intensity is half of the peak value.

Due to use of high power COB's with this product, special attention to proper thermal design is highly recommended. LEDiL has no liability for direct, indirect or consecutive damages arising from the LEDiL products being used outside of the recommended temperature range.

MATERIALS:

As part of our continuous research and improvement processes, and to ensure the best possible quality and availability of our products, LEDiL reserves the right to change material grades without notice.

PRODUCT DATA USER AGREEMENT AND DISCLAIMER:

The measured data in the provided downloadable LEDiL Product Datasheets and Mechanical 2D-Drawings is rounded and provided as reference for planning. LEDiL Oy's optical specifications have been verified by conducting performance testing of the products in accordance with the company's quality system. The reported data are averaged results of multiple measurements with typical variation. LEDiL Oy reserves the right to without prior notification make changes and improvements to its products.

LEDiL Oy assumes neither warranty, nor guarantee nor any other liability of any kind for the contents and correctness of the provided data. The provided data has been generated with highest diligence but the provided data may in reality not represent the complete possible variation range of all intrinsic parameters. Therefore, in certain cases a deviation from the provided data could occur.

LEDiL Oy reserves the right to undertake technical changes of its products without further notification which could lead to changes in the provided data. LEDiL Oy assumes no liability of any kind for the possible deviation from any provided data or any other damage resulting from the usage of the provided data.

The user agrees to this disclaimer and user agreement with the download or usage of the provided files.

LEDiL Oy

Joensuunkatu 13
FI-24240 SALO
Finland

LEDiL Inc.

228 West Page Street
Suite D
Sycamore IL 60178
USA

Ledil Optics Technology (Shenzhen) Co., Ltd.

405 , Block B
Casic Motor Building
Shenzhen 518057
P.R.CHINA

Local sales and technical support

[www.ledil.com/
where_to_buy](http://www.ledil.com/where_to_buy)

Shipping locations

Salo, Finland
Hong Kong, China

Distribution Partners

[www.ledil.com/
where_to_buy](http://www.ledil.com/where_to_buy)

Mouser Electronics

Authorized Distributor

Click to View Pricing, Inventory, Delivery & Lifecycle Information:

[Ledi:](#)

[C16731_ILONA-SS](#)