

FLARE-MAXI-D

34 x 33 mm lens with ~110° x 15° diffused oval beam

SPECIFICATION:

Dimensions	33.9 x 33.3 mm
Height	16.5 mm
Fastening	glue, pin
ROHS compliant	yes ⓘ



MATERIALS:

Component	Type	Material	Colour	Finish
FLARE-MAXI-D	Single lens	PMMA	clear	

ORDERING INFORMATION:

Component	Qty in box	MOQ	MPQ	Box weight (kg)
C13012_FLARE-MAXI-D » Box size: 451 x 254 x 197 mm	840		168	9.7

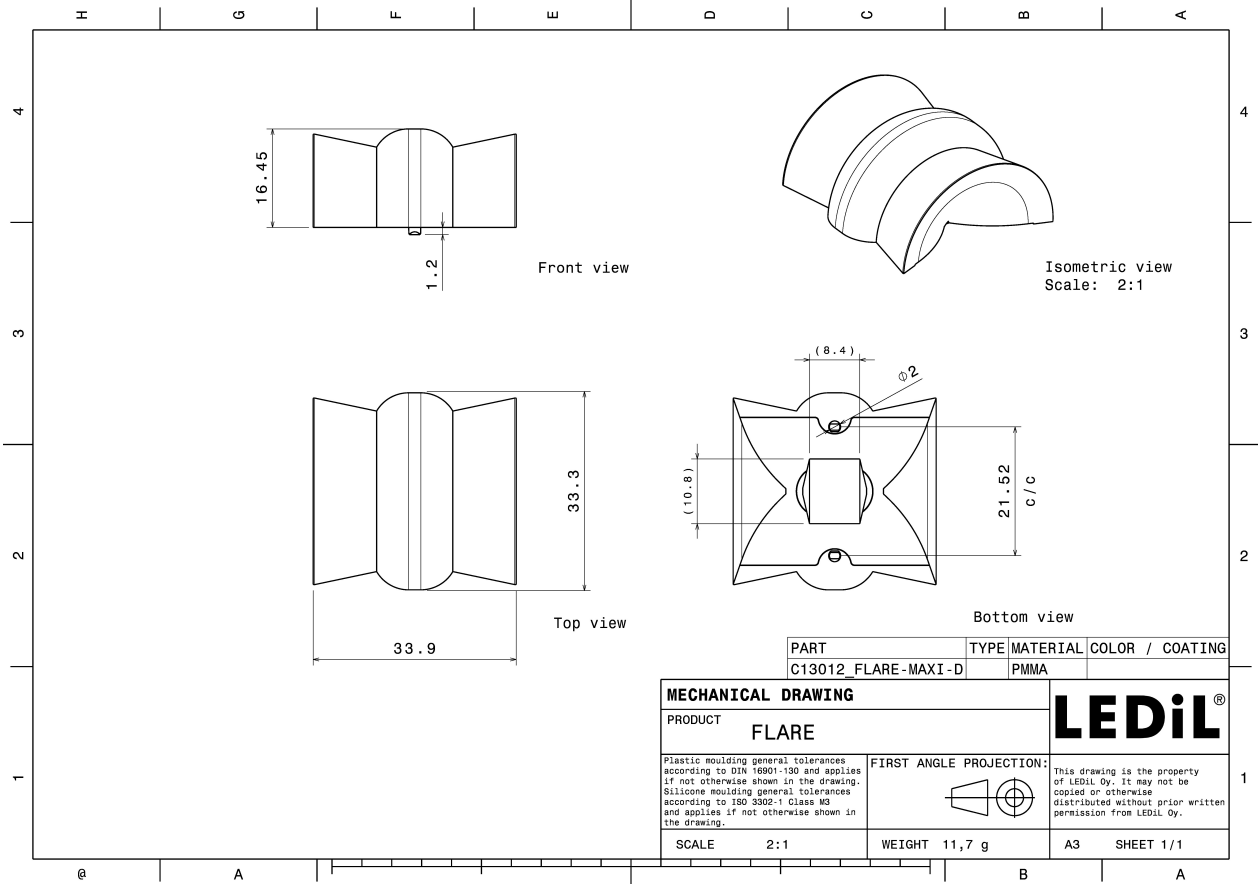

See also our general installation guide: www.ledil.com/installation_guide

OPTICAL RESULTS (MEASURED):



LED MK-R
 FWHM / FWTM 100.0 + 23.0° / 148.0 + 36.0°
 Efficiency 92 %
 Peak intensity 1.2 cd/lm
 LEDs/each optic 1
 Light colour White
 Required components:

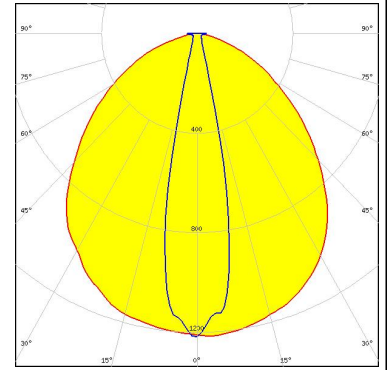

LED XHP50
 FWHM / FWTM 104.0 + 19.0° / 151.0 + 35.0°
 Efficiency 92 %
 Peak intensity 1.3 cd/lm
 LEDs/each optic 1
 Light colour White
 Required components:

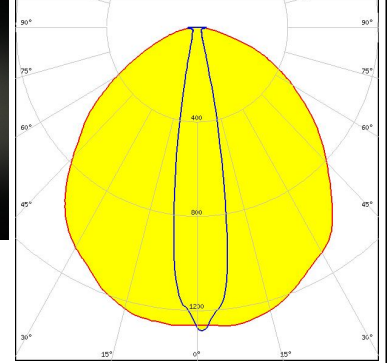
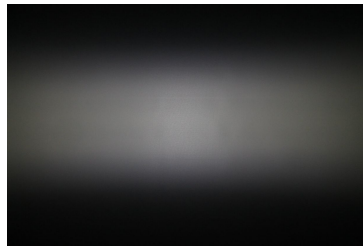

LED XHP70
 FWHM / FWTM 104.0 + 28.0° / 153.0 + 44.0°
 Efficiency 92 %
 Peak intensity 0.9 cd/lm
 LEDs/each optic 1
 Light colour White
 Required components:

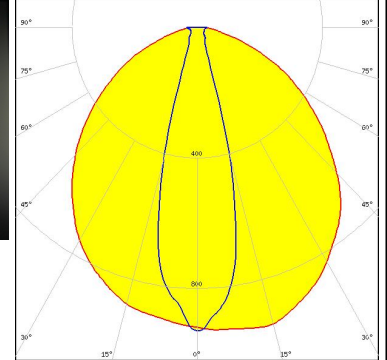
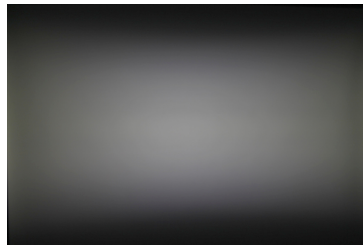

LED XM-L
 FWHM / FWTM 110.0 + 15.0° / 151.0 + 27.0°
 Efficiency 94 %
 Peak intensity 1.7 cd/lm
 LEDs/each optic 1
 Light colour White
 Required components:

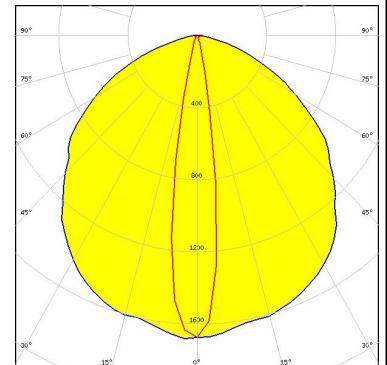

OPTICAL RESULTS (MEASURED):



LED XM-L2
 FWHM / FWTM 101.0 + 17.0° / 146.0 + 28.0°
 Efficiency 94 %
 Peak intensity 1.9 cd/lm
 LEDs/each optic 1
 Light colour White
 Required components:

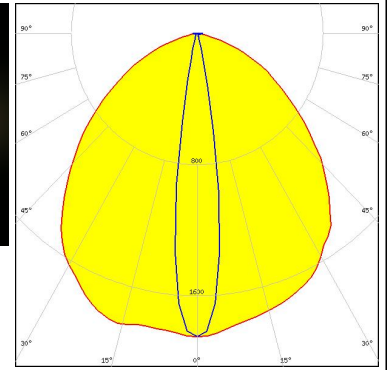
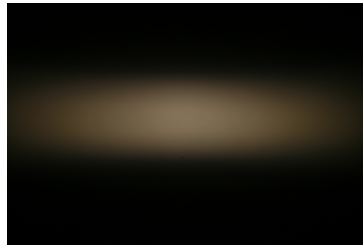

LED XP-G
 FWHM / FWTM 115.0 + 15.0° / 155.0 + 23.0°
 Efficiency 94 %
 Peak intensity 1.9 cd/lm
 LEDs/each optic 1
 Light colour White
 Required components:

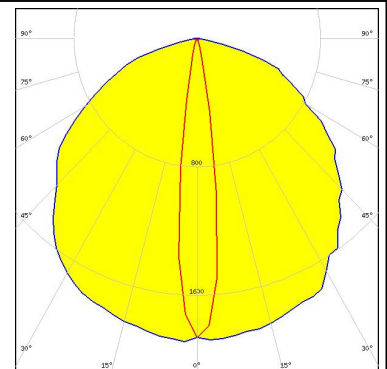

LED XP-G2
 FWHM / FWTM 106.0 + 14.0° / 150.0 + 24.0°
 Efficiency 94 %
 Peak intensity 2 cd/lm
 LEDs/each optic 1
 Light colour White
 Required components:

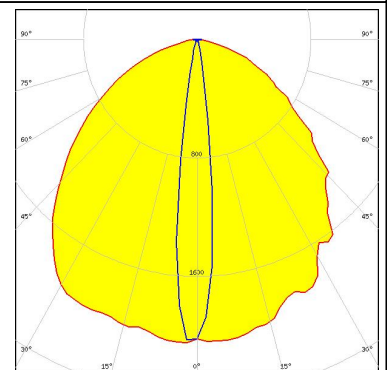

LED XP-L HD
 FWHM / FWTM 119.0 + 16.0° / 154.0 + 27.0°
 Efficiency 94 %
 Peak intensity 1.5 cd/lm
 LEDs/each optic 1
 Light colour White
 Required components:

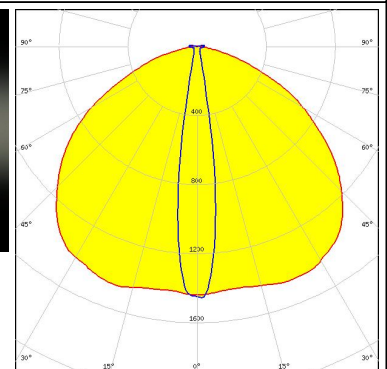
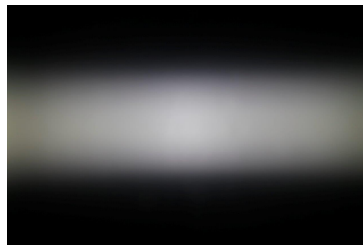

OPTICAL RESULTS (MEASURED):



LED XP-L2
 FWHM / FWTM 107.0 + 16.0° / 159.0 + 28.0°
 Efficiency 94 %
 Peak intensity 1.5 cd/lm
 LEDs/each optic 1
 Light colour White
 Required components:

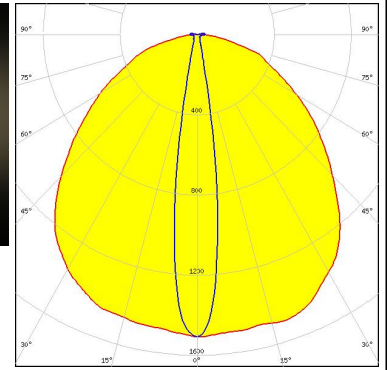

LED XT-E
 FWHM / FWTM 117.0 + 14.0° / 159.0 + 26.0°
 Efficiency 94 %
 Peak intensity 1.9 cd/lm
 LEDs/each optic 1
 Light colour White
 Required components:

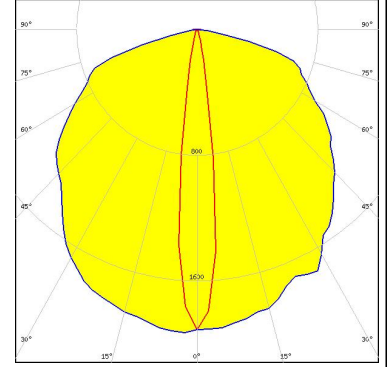

LED LUXEON A
 FWHM / FWTM 104.0 + 12.0° / 147.0 + 25.0°
 Efficiency 94 %
 Peak intensity 2.1 cd/lm
 LEDs/each optic 1
 Light colour White
 Required components:

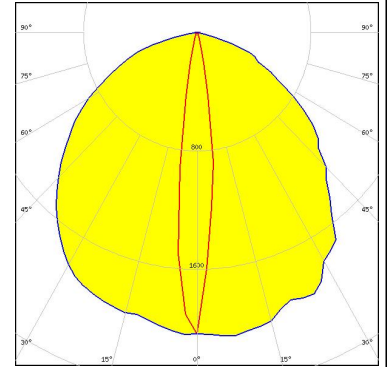

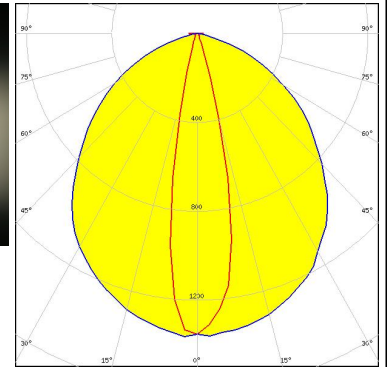
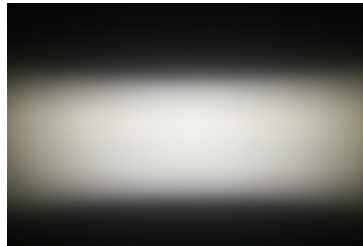

LED LUXEON M/MX
 FWHM / FWTM 102.0 + 25.0° / 146.0 + 39.0°
 Efficiency 94 %
 Peak intensity 1.4 cd/lm
 LEDs/each optic 1
 Light colour White
 Required components:

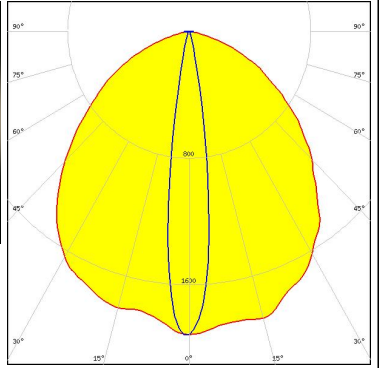
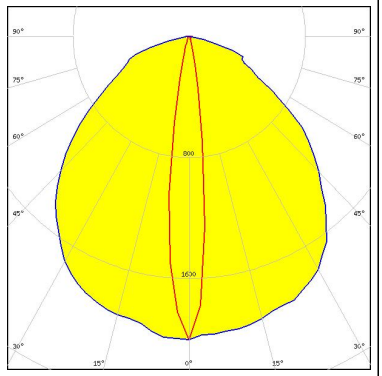
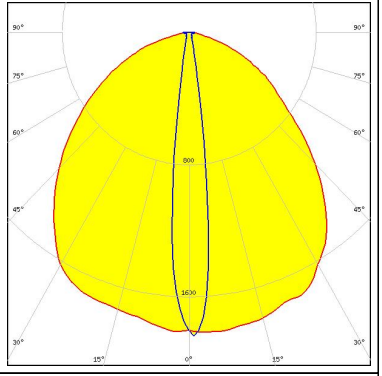
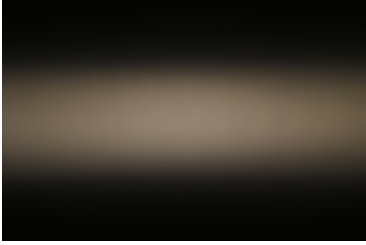
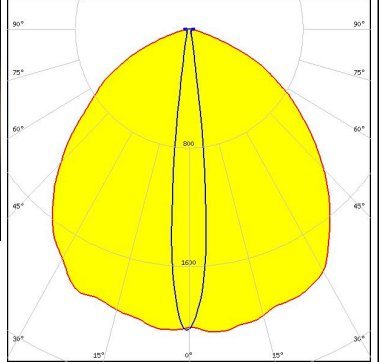

OPTICAL RESULTS (MEASURED):

<p>LUMILEDS</p> <p>LED LUXEON MZ</p> <p>FWHM / FWTM 101.0 + 16.0° / 146.0 + 27.0°</p> <p>Efficiency 94 %</p> <p>Peak intensity 1.9 cd/lm</p> <p>LEDs/each optic 1</p> <p>Light colour White</p> <p>Required components:</p>		
<p>LUMILEDS</p> <p>LED LUXEON Rebel ES</p> <p>FWHM / FWTM 104.0 + 13.0° / 150.0 + 25.0°</p> <p>Efficiency 94 %</p> <p>Peak intensity 2 cd/lm</p> <p>LEDs/each optic 1</p> <p>Light colour White</p> <p>Required components:</p>		
<p>LUMILEDS</p> <p>LED LUXEON T</p> <p>FWHM / FWTM 102.0 + 13.0° / 149.0 + 25.0°</p> <p>Efficiency 92 %</p> <p>Peak intensity 1.8 cd/lm</p> <p>LEDs/each optic 1</p> <p>Light colour White</p> <p>Required components:</p>		
<p>LUMILEDS</p> <p>LED LUXEON TX</p> <p>FWHM / FWTM 103.0 + 13.0° / 143.0 + 22.0°</p> <p>Efficiency 93 %</p> <p>Peak intensity 2.1 cd/lm</p> <p>LEDs/each optic 1</p> <p>Light colour White</p> <p>Required components:</p>		

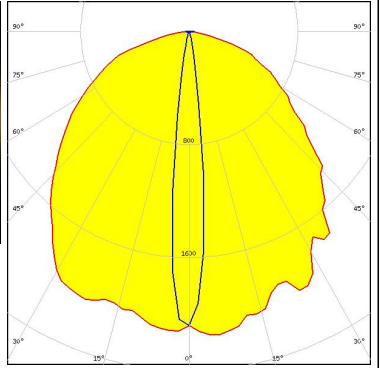
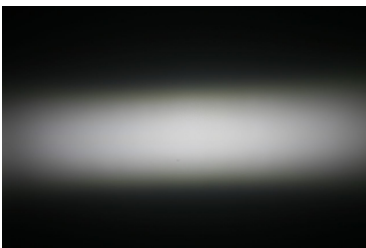
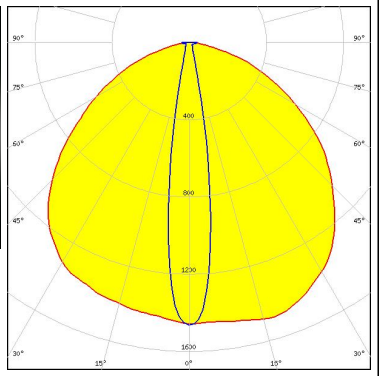
OPTICAL RESULTS (MEASURED):

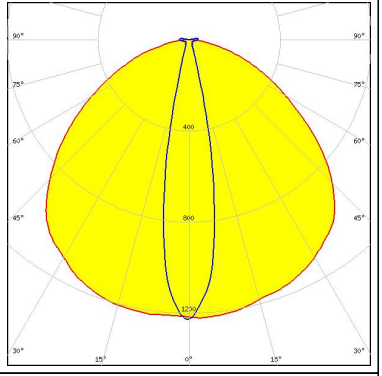
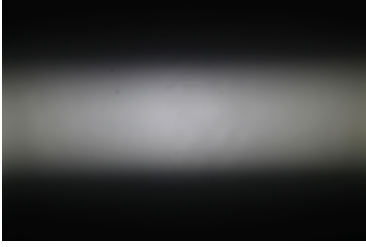
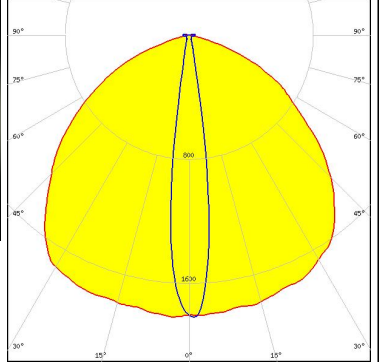
<p>NICHIA</p> <p>LED NCSxx19B FWHM / FWTM 107.0 + 13.0° / 156.0 + 23.0° Efficiency 94 % Peak intensity 2.1 cd/lm LEDs/each optic 1 Light colour White Required components:</p>		
<p>NICHIA</p> <p>LED NS9x383 FWHM / FWTM 110.0 + 16.0° / 152.0 + 30.0° Efficiency 93 % Peak intensity 1.5 cd/lm LEDs/each optic 1 Light colour White Required components:</p>		
<p>NICHIA</p> <p>LED NV4x144A FWHM / FWTM 111.0 + 20.0° / 145.0 + 144.0° Efficiency 89 % Peak intensity 0.6 cd/lm LEDs/each optic 1 Light colour White Required components:</p>		
<p>NICHIA</p> <p>LED NVSW219F FWHM / FWTM 109.0 + 14.0° / 146.0 + 24.0° Efficiency 94 % Peak intensity 1.9 cd/lm LEDs/each optic 1 Light colour White Required components:</p>		

OPTICAL RESULTS (MEASURED):



LED NVSxx19B/NVSxx19C
 FWHM / FWTM 116.0 + 13.0° / 154.0 + 25.0°
 Efficiency 94 %
 Peak intensity 1.7 cd/lm
 LEDs/each optic 1
 Light colour White
 Required components:

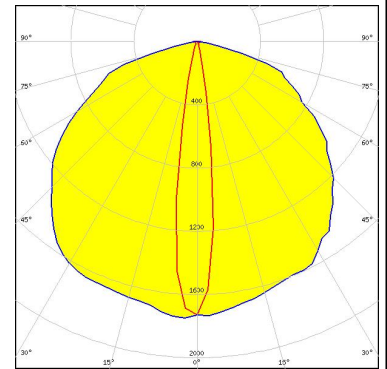

LED NWSx229A
 FWHM / FWTM 117.0 + 15.0° / 151.0 + 26.0°
 Efficiency 92 %
 Peak intensity 1.6 cd/lm
 LEDs/each optic 1
 Light colour White
 Required components:

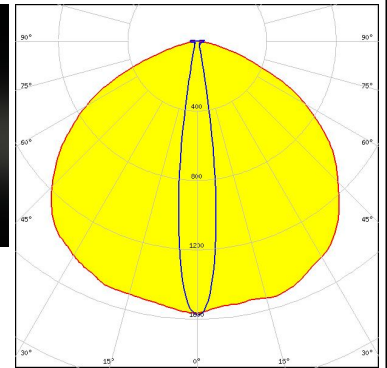
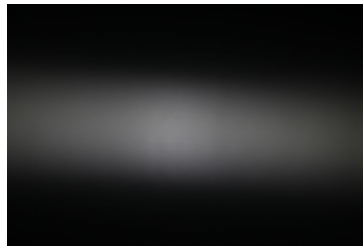

LED Duris S10
 FWHM / FWTM 92.0 + 20.0° / 144.0 + 36.0°
 Efficiency 93 %
 Peak intensity 1.6 cd/lm
 LEDs/each optic 1
 Light colour White
 Required components:

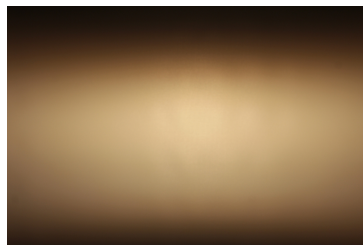

LED OSLOM Square EC
 FWHM / FWTM 99.0 + 14.0° / 149.0 + 27.0°
 Efficiency 94 %
 Peak intensity 2 cd/lm
 LEDs/each optic 1
 Light colour White
 Required components:

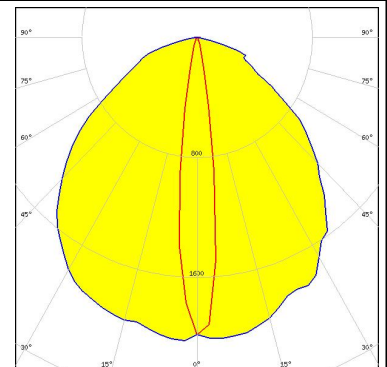

OPTICAL RESULTS (MEASURED):

OSRAM

Opto Semiconductors

LED OSLON Square PC
 FWHM / FWTM 104.0 + 12.0° / 150.0 + 25.0°
 Efficiency 94 %
 Peak intensity 2 cd/lm
 LEDs/each optic 1
 Light colour White
 Required components:

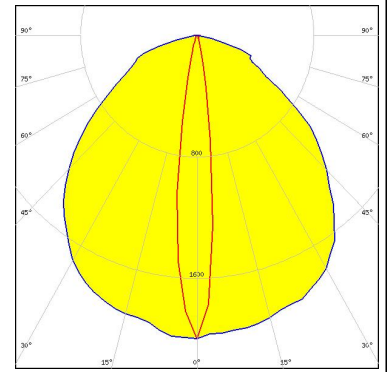

OSRAM

Opto Semiconductors

LED OSLON SSL 150
 FWHM / FWTM 128.0 + 13.0° / 152.0 + 23.0°
 Efficiency 94 %
 Peak intensity 2 cd/lm
 LEDs/each optic 1
 Light colour White
 Required components:

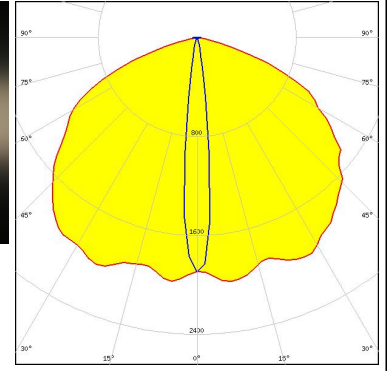
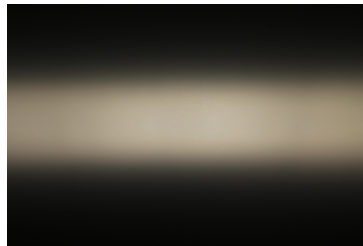

SAMSUNG

LED LH351Z
 FWHM / FWTM 98.0 + 13.0° / 128.0 + 22.0°
 Efficiency 94 %
 Peak intensity 2.2 cd/lm
 LEDs/each optic 1
 Light colour White
 Required components:

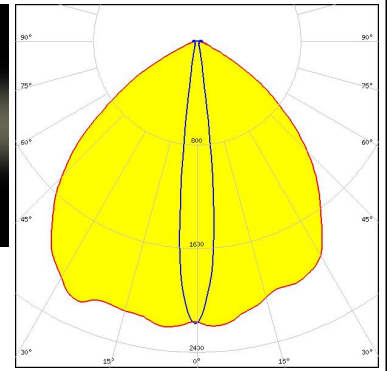
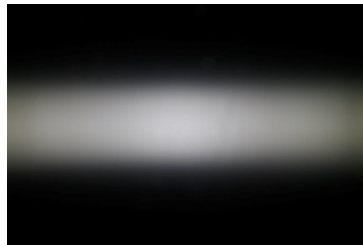

SEOUL SEMICONDUCTOR

LED Z5M1/Z5M2
 FWHM / FWTM 104.0 + 14.0° / 144.0 + 25.0°
 Efficiency 94 %
 Peak intensity 2.1 cd/lm
 LEDs/each optic 1
 Light colour White
 Required components:

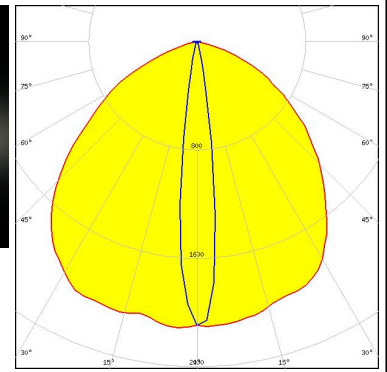
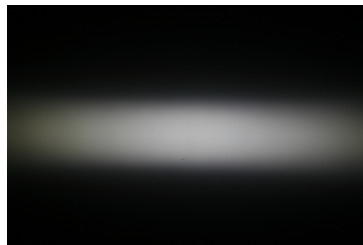

OPTICAL RESULTS (MEASURED):



OPTICAL RESULTS (SIMULATED):



LED XHP50.2
 FWHM / FWTM 92.0 + 20.0° / 144.0 + 34.0°
 Efficiency 94 %
 Peak intensity 1.5 cd/lm
 LEDs/each optic 1
 Light colour White
 Required components:

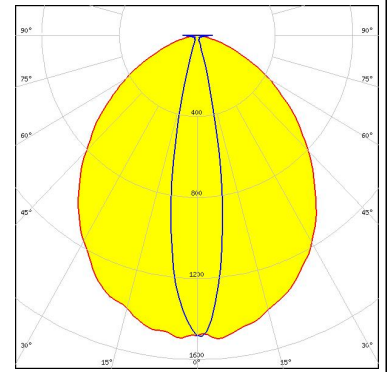

LED XHP50.3 HD
 FWHM / FWTM 88.0 + 18.0° / 139.0 + 30.0°
 Efficiency 95 %
 Peak intensity 1.7 cd/lm
 LEDs/each optic 1
 Light colour White
 Required components:

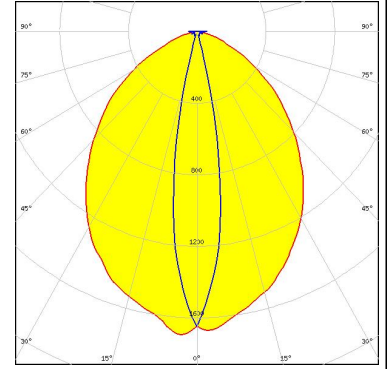

LED XP-G2 HE
 FWHM / FWTM 84.0 + 13.0° / 140.0 + 21.0°
 Efficiency 95 %
 Peak intensity 2.3 cd/lm
 LEDs/each optic 1
 Light colour White
 Required components:

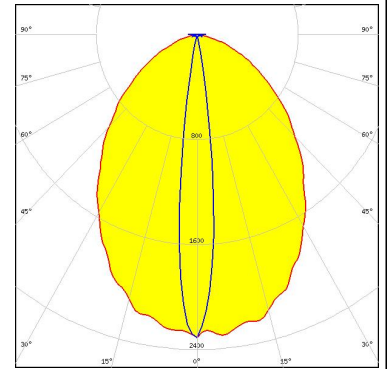

LED XP-G3
 FWHM / FWTM 82.0 + 12.0° / 145.0 + 20.0°
 Efficiency 95 %
 Peak intensity 2.4 cd/lm
 LEDs/each optic 1
 Light colour White
 Required components:

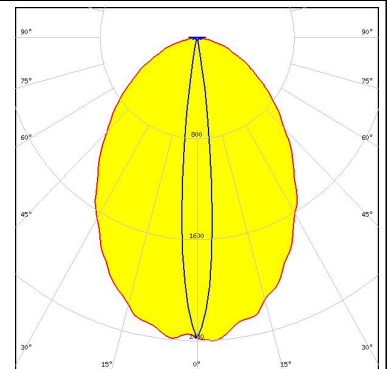

OPTICAL RESULTS (SIMULATED):

LUMILEDS

LED LUXEON 7070
 FWHM / FWTM 89.0 + 22.0° / 144.0 + 38.0°
 Efficiency 95 %
 Peak intensity 1.4 cd/lm
 LEDs/each optic 1
 Light colour White
 Required components:

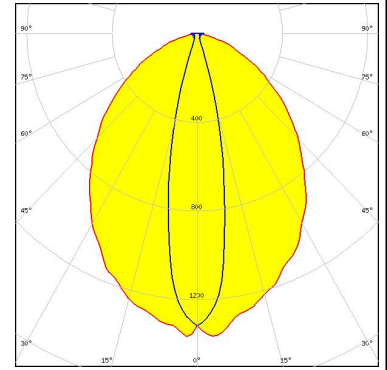

LUMILEDS

LED LUXEON H50-2
 FWHM / FWTM 10.0 + 65.0° / 18.0 + 126.0°
 Efficiency 92 %
 Peak intensity 3.3 cd/lm
 LEDs/each optic 1
 Light colour White
 Required components:

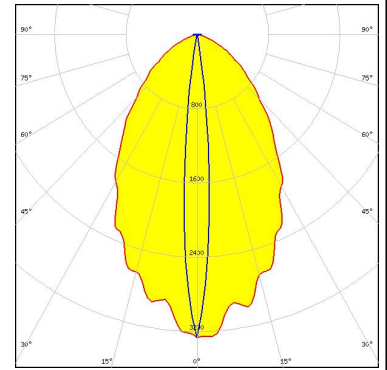

OSRAM

Opto Semiconductors
 LED OSCONIQ P 7070
 FWHM / FWTM 86.0 + 18.0° / 142.0 + 28.0°
 Efficiency 92 %
 Peak intensity 1.7 cd/lm
 LEDs/each optic 1
 Light colour White
 Required components:

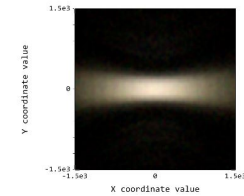

Detector image: illuminance
 OSRAM
 C13012_FLARE-MAXI-D_P005_P08-200
 configuration 1 of 1

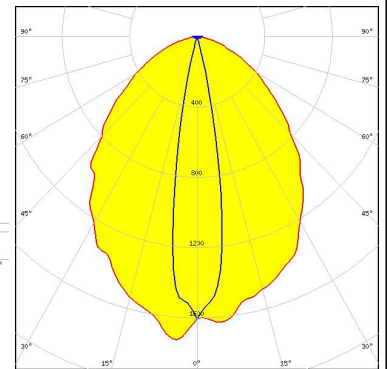

GENERAL INFORMATION:

NOTE: The typical beam angle will be changed by different color, chip size and chip position tolerance. The typical total beam angle is the full angle measured where the luminous intensity is half of the peak value.

MATERIALS:

As part of our continuous research and improvement processes, and to ensure the best possible quality and availability of our products, LEDiL reserves the right to change material grades without notice.

PRODUCT DATA USER AGREEMENT AND DISCLAIMER:

The measured data in the provided downloadable LEDiL Product Datasheets and Mechanical 2D-Drawings is rounded and provided as reference for planning. LEDiL Oy's optical specifications have been verified by conducting performance testing of the products in accordance with the company's quality system. The reported data are averaged results of multiple measurements with typical variation. LEDiL Oy reserves the right to without prior notification make changes and improvements to its products.

LEDiL Oy assumes neither warranty, nor guarantee nor any other liability of any kind for the contents and correctness of the provided data. The provided data has been generated with highest diligence but the provided data may in reality not represent the complete possible variation range of all intrinsic parameters. Therefore, in certain cases a deviation from the provided data could occur.

LEDiL Oy reserves the right to undertake technical changes of its products without further notification which could lead to changes in the provided data. LEDiL Oy assumes no liability of any kind for the possible deviation from any provided data or any other damage resulting from the usage of the provided data.

The user agrees to this disclaimer and user agreement with the download or usage of the provided files.

LEDiL Oy

Joensuunkatu 13
FI-24240 SALO
Finland

LEDiL Inc.

228 West Page Street
Suite D
Sycamore IL 60178
USA

Ledil Optics Technology (Shenzhen) Co., Ltd.

405 , Block B
Casic Motor Building
Shenzhen 518057
P.R.CHINA

Local sales and technical support

[www.ledil.com/
where_to_buy](http://www.ledil.com/where_to_buy)

Shipping locations

Salo, Finland
Hong Kong, China

Distribution Partners

[www.ledil.com/
where_to_buy](http://www.ledil.com/where_to_buy)

Mouser Electronics

Authorized Distributor

Click to View Pricing, Inventory, Delivery & Lifecycle Information:

[Ledil:](#)

[C13012_FLARE-MAXI-D](#)