

# Smallest book-style EMC/RFI Filter for Inverter and Power Drive Systems



- Standard and high performance EMC solution
- Footprint space-saving book-style housing
- Solid safety connector blocks
- Standard attenuation performance FN 3287
- High attenuation performance FN 3288
- HV versions for 690 VAC applications
- HVIT- and IT versions for IT distribution networks
- Versions with low leakage current



### Performance indicators

Attenuation performance

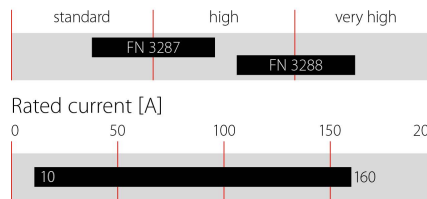

### Approvals



600 VAC

### Features and benefits

- FN 3287 and FN 3288 series of filters provides state-of-the-art EMI attenuation based on an innovative filter topology. They help to ensure compliance with Class C2 or even C1 limits.
- The slim book-style shape allows a convenient and space-saving installation next to inverters, converters or motor drives.
- The compact FN3287 and FN3288 filter from 10 to 160A are designed for the most diverse applications worldwide, including machinery and machine tools.
- FN 3288 HV filters up to 160 A are applicable for 690 VAC distribution networks.
- FN 3288IT and FN 3288HVIT filters up to 160 A meet the special requirements for IT distribution networks.
- Low leakage current filter versions help to fulfill tough requirements (<3.5 mA) in respect of leakage current limitation.

### Technical specifications

<b>Maximum continuous operating voltage</b>	3x 530/305 VAC (FN 3287, FN 3288) 3x 530 VAC (FN 3288 IT) 3x 760/440 VAC (FN 3288 HV) 3x 760 VAC (FN 3288 HVIT)
<b>Rated currents</b>	10 to 160 A @50°C
<b>Operating frequency</b>	DC to 60 Hz
<b>High potential test voltage</b>	P -> E 2260 VDC for 2 s (FN 3287, FN 3288) P -> E 2900 VDC for 2 s (FN 3288 IT) P -> P 2280 VDC for 2 s (FN 3287, FN 3288, FN 3288 IT) P -> E 2650 VDC for 2 s (FN 3288 HV) P -> E 3530 VDC for 2 s (FN 3288 HVIT) P -> P 3270 VDC for 2 s (FN 3288 HV)
<b>Oversvoltage category</b>	II acc. IEC 60664-1
<b>Pollution degree</b>	2 acc. IEC 60664-1
<b>Protection category</b>	IP 20 acc. to IEC 60529
<b>Overload capability</b>	6x rated current for 1 sec, once per hour 1.5x rated current for 1 minute, once per hour
<b>Temperature range (operation and storage)</b>	-40°C to +100°C (with current derating >50°C)
<b>Climatic class</b>	-40/100/21 acc. to IEC 60068-1
<b>Vibration and shock</b>	3M4 (operation); 2M2 (transport) acc. to IEC 60721-3-3; IEC 60721-3-2
<b>Flammability according to</b>	UL 94 V-0
<b>Compliance with insulation requirement</b>	> 1MΩ acc. to IEC 60204-1
<b>Design corresponding to</b>	UL 60939-3, IEC 60939-3
<b>MTBF</b>	> 200,000 hours

### Typical applications

- Three-phase variable speed drives and power drive systems (PDS)
- Machine tool and machinery equipment
- IT power distribution networks (FN 3288IT and FN 3288 HVIT)
- General energy conversion devices (inverters, converters)
- Process automation equipment
- Three-phase power supplies
- Low-leakage current requirements

### Typical electrical schematic

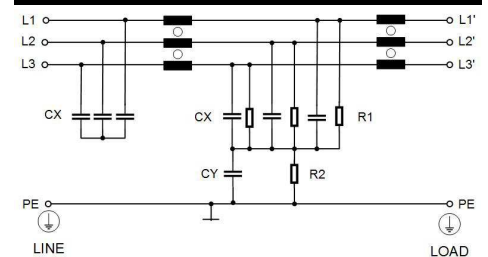

Note: IT and HVIT versions without discharge resistor to ground.

## Filter selection table

Filter	Rated current @ 50°C (40°C)	Typical drive power rating**	Leakage current*** @ 530 VAC/50 Hz	Power loss @ 25°C	Terminal Type	Weight [kg]	Frame
	[A]	[kW]	[mA]	[W]			
<b>Standard performance*:</b>							
FN 3287-10-44-C28-R65	10 (11)	5.5	3.7	6.9	-44	0.7	Q
FN 3287-16-44-C33-R65	16 (17)	7.5	4.3	8.5	-44	0.8	R
FN 3287-20-33-C33-R65	20 (22)	11	4.9	9.4	-33	0.9	S
FN 3287-25-33-C33-R65	25 (27)	15	4.9	11.0	-33	1.0	S
FN 3287-40-33-C33-R65	40 (44)	22	4.9	19.2	-33	1.5	T
FN 3287-50-53-C33-R65	50 (55)	30	4.9	21.7	-53	2.1	U
FN 3287-63-53-C33-R65	63 (69)	37	4.9	27.4	-53	2.2	U
FN 3287-80-34-C33-R65	80 (88)	45	5.6	32.6	-34	3.4	F
FN3287-100-35-C33-R65	100 (110)	55	5.6	33.0	-35	4.2	G
FN3287-125-35-C33-R65	125 (137)	75	5.6	37.5	-35	4.6	G
FN3287-160-40-C33-R65	160 (175)	90	5.6	38.4	-40	6.0	H
<b>High performance (HP)*:</b>							
FN 3288-10-44-C34-R65	10 (11)	5.5	5.9	6.8	-44	0.8	A
FN 3288-16-44-C35-R65	16 (17)	7.5	6.0	9.2	-44	1.0	B
FN 3288-20-33-C35-R65	20 (22)	11	6.0	10.0	-33	1.2	C
FN 3288-25-33-C35-R65	25 (27)	15	6.0	16.9	-33	1.2	C
FN 3288-40-33-C35-R65	40 (44)	22	6.0	20.2	-33	1.8	D
FN 3288-50-53-C35-R65	50 (55)	30	6.6	24.0	-53	2.5	E
FN 3288-63-53-C35-R65	63 (69)	37	6.6	34.5	-53	2.7	E
FN 3288-80-34-C35-R65	80 (88)	45	7.1	28.8	-35	4.3	F
FN 3288-100-35-C35-R65	100 (110)	55	7.1	36.0	-35	5.1	G
FN 3288-125-35-C35-R65	125 (137)	75	7.1	42.2	-35	5.0	G
FN 3288-160-40-C35-R65	160 (175)	90	7.1	46.1	-40	6.6	H
<b>HP for IT power networks****:</b>							
FN 3288IT-10-44-C34-R60	10 (11)	5.5	5.9	6.2	-44	1.1	I
FN 3288IT-16-44-C34-R60	16 (17)	7.5	5.9	9.6	-44	1.3	J
FN 3288IT-20-33-C34-R60	20 (22)	11	5.9	13.2	-33	1.6	K
FN 3288IT-25-33-C34-R60	25 (27)	15	5.9	15.6	-33	1.6	K
FN 3288IT-40-33-C34-R60	40 (44)	22	5.9	18.7	-33	2.8	L
FN 3288IT-50-53-C34-R60	50 (55)	30	6.5	22.2	-53	2.8	M
FN 3288IT-63-53-C34-R60	63 (69)	37	6.5	29.8	-53	2.9	M
FN 3288IT-80-34-C34-R60	80 (88)	45	7.0	28.8	-34	4.6	N
FN 3288IT-100-35-C34-R60	100 (110)	55	7.0	33.0	-35	5.4	O
FN 3288IT-125-35-C34-R60	125 (137)	75	7.0	42.2	-35	5.3	O
FN 3288IT-160-40-C34-R60	160 (175)	90	7.0	46.1	-40	6.9	P

\* Additional FN 3287 and FN 3288 filter versions with lower leakage currents available -> replace Cxx with C26.

\*\* Typical power rating at 400 VAC for FN 3287 and FN 3288 with  $\cos \phi = 0.85$ . The exact value depends upon the efficiency of the drive, the motor and the entire application.

\*\*\* Standardized calculated leakage current acc. IEC 60939 under normal operating conditions (FN 3287, FN 3288 and FN 3288 IT at 530 VAC).

\*\*\*\* These filters may be operated in IT system as long as the operation conditions and possible short circuit/fault (earth connection of one conductor) occurs between the supply (line side) and the filter. The filters are not designed for short circuit/faults occurring between converter and motor.

## Filter selection table

Filter*	Rated current @ 50°C (40°C)	Typical drive power rating**	Leakage current*** @ 760 VAC/50 Hz	Power loss @ 25°C	Input/Output Connections	Weight [kg]	Frame
	[A]	[kW]	[mA]	[W]			
<b>High voltage versions*:</b>							
FN 3288HV-10-44-C34-R65	10 (11)	10	8.4	6.9	-44	1.2	I
FN 3288HV-16-44-C34-R65	16 (17)	16	8.4	10.8	-44	1.5	J
FN 3288HV-20-33-C36-R65	20 (22)	20	10.9	12.0	-33	1.8	K
FN 3288HV-25-33-C36-R65	25 (27)	25	10.9	14.6	-33	1.9	K
FN 3288HV-40-33-C36-R65	40 (44)	40	12.4	19.2	-33	2.9	L
FN 3288HV-50-53-C36-R65	50 (55)	50	12.4	26.3	-53	3.3	M
FN 3288HV-63-53-C36-R65	63 (69)	64	12.4	32.1	-53	3.5	M
FN 3288HV-80-34-C36-R65	80 (88)	80	12.4	28.8	-34	4.9	N
FN 3288HV-100-35-C36-R65	100 (110)	100	12.4	33.0	-35	5.8	O
FN 3288HV-125-35-C36-R65	125 (137)	125	12.4	42.0	-35	5.9	O
FN 3288HV-160-40-C36-R65	160 (175)	160	12.4	46.1	-40	7.2	P
<b>HV for IT power networks****:</b>							
FN 3288HVIT-10-44-C42-R60	10 (11)	10	4.6	6.9	-44	1.2	I
FN 3288HVIT-16-44-C43-R60	16 (17)	16	6.8	10.8	-44	1.5	J
FN 3288HVIT-20-33-C43-R60	20 (22)	20	6.8	12.0	-33	1.8	K
FN 3288HVIT-25-33-C43-R60	25 (27)	25	6.8	14.6	-33	1.9	K
FN 3288HVIT-40-33-C43-R60	40 (44)	40	6.8	19.2	-33	2.9	L
FN 3288HVIT-50-53-C43-R60	50 (55)	50	6.8	26.3	-53	3.3	M
FN 3288HVIT-63-53-C43-R60	63 (69)	64	6.8	32.1	-53	3.5	M
FN 3288HVIT-80-34-C43-R60	80 (88)	80	6.8	28.8	-34	4.9	N
FN 3288HVIT-100-35-C43-R60	100 (110)	100	6.8	33.0	-35	5.8	O
FN 3288HVIT-125-35-C44-R60	125 (137)	125	5.9	42.2	-35	5.9	O
FN 3288HVIT-160-40-C43-R60	160 (175)	160	6.8	46.1	-40	7.2	P

\* Additional filter versions with lower leakage currents (lower Cy capacitors) available -> replace Cxx with C25.

\*\* Typical power rating (400 VAC for FN 3287 and FN 3288 / 690 VAC for FN 3288 HV and FN 3288 HVIT) with  $\cos \phi=0.85$ . The exact value depends upon the efficiency of the drive, the motor and the entire application.

\*\*\* Standardized calculated leakage current acc. IEC 60939 under normal operating conditions (FN 3287, FN 3288 and FN 3288 IT at 480 VAC, FN 3288 HV and FN 3288 HVIT at 690 VAC).

\*\*\*\*These filters may be operated in IT system as long as the operation conditions and possible short circuit/fault (earth connection of one conductor) occurs between the supply (line side) and the filter. The filters are not designed for short circuit/faults occurring between converter and motor.

### Typical filter attenuation – FN 3287

(FN 3287 standard performance version with standard leakage current)

Per CISPR 17: symmetrical 50 Ω/50 Ω -> Differential Mode (DM); asymmetrical 50 Ω/50 Ω -> Common Mode (CM)

FN 3287: 10 A

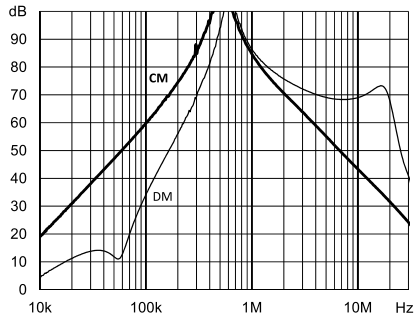

FN 3287: 16 A

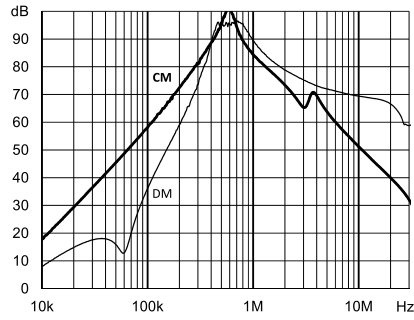

FN 3287: 20 A

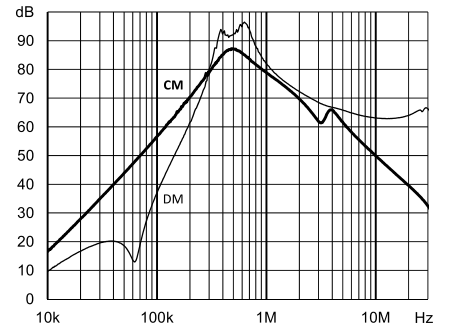

FN 3287: 25 A

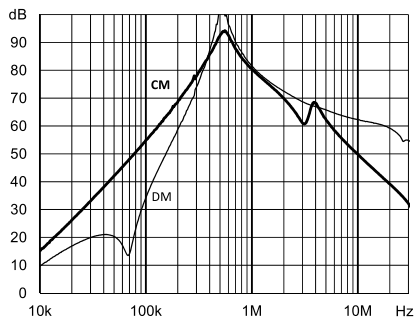

FN 3287: 40 A

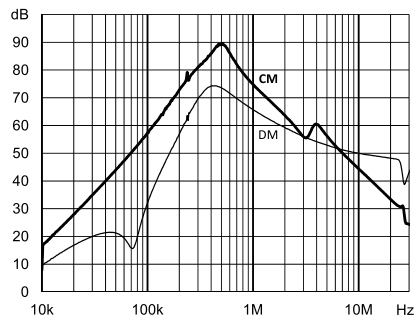

FN 3287: 50 A

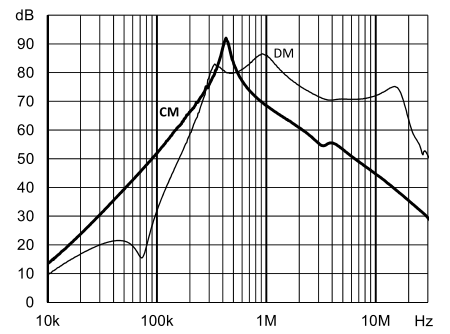

FN 3287: 63 A

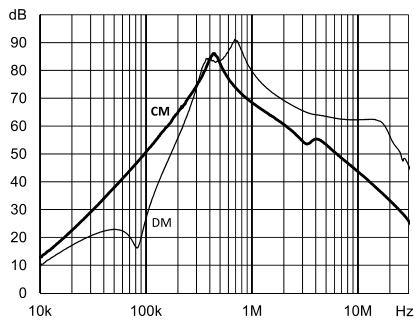

FN 3287: 80 A

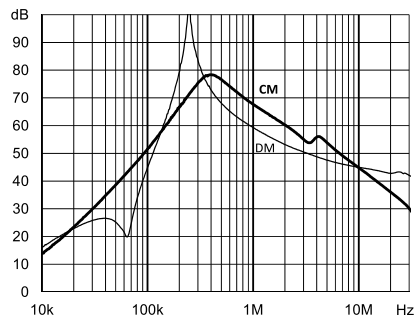

FN 3287: 100 A

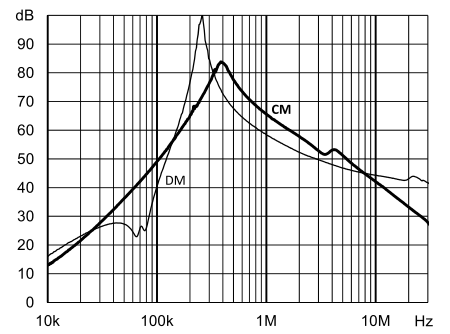

FN 3287: 125 A

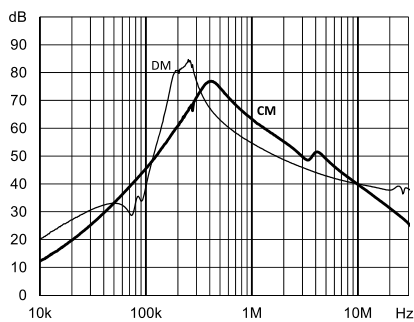

FN 3287: 160 A

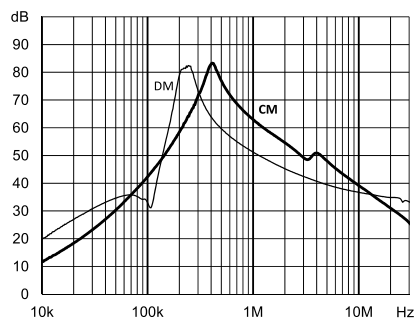

### Typical filter attenuation – FN 3288

(FN 3288 standard performance version with standard leakage current)

Per CISPR 17: symmetrical 50 Ω/50 Ω -> Differential Mode (DM); asymmetrical 50 Ω/50 Ω -> Common Mode (CM)

FN 3288: 10 A

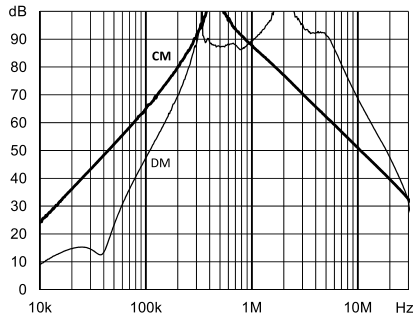

FN 3288: 16 A

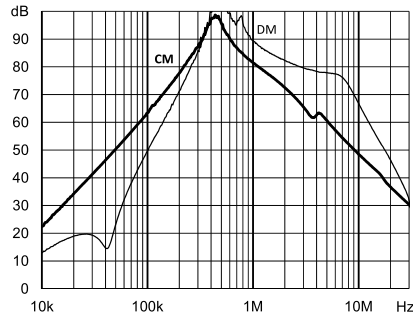

FN 3288: 20 A

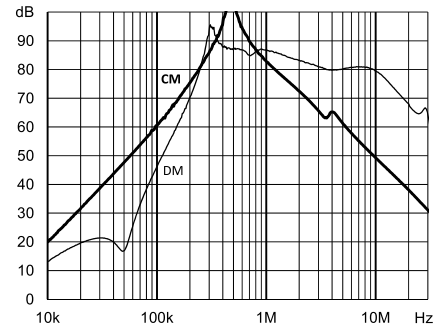

FN 3288: 25 A

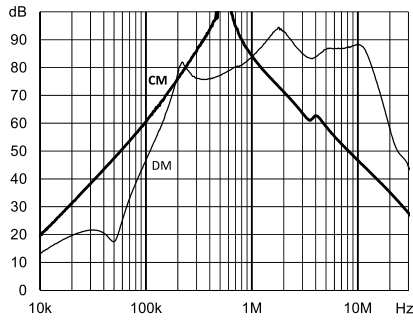

FN 3288: 40 A

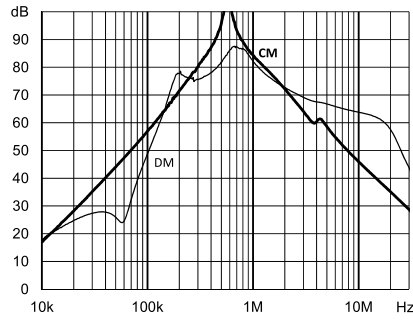

FN 3288: 50 A

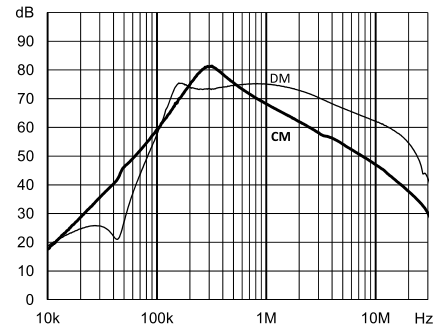

FN 3288: 63 A

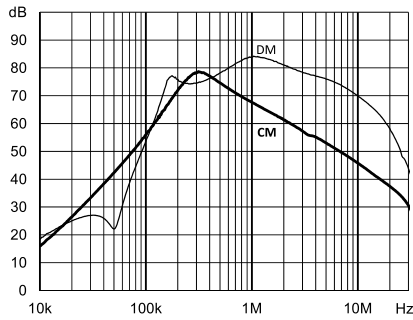

FN 3288: 80 A

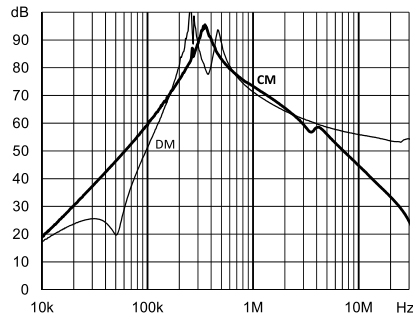

FN 3288: 100 A

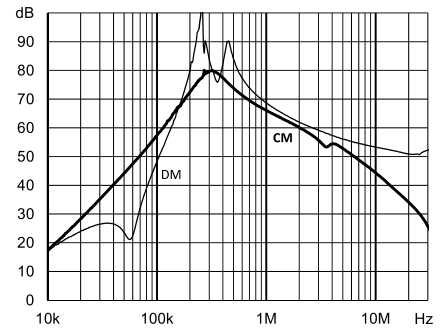

FN 3288: 125 A

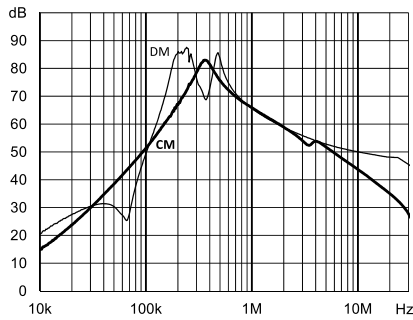

FN 3288: 160 A

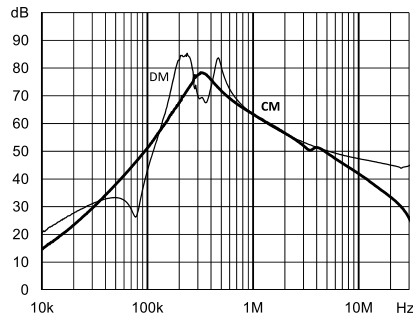

## Mechanical data

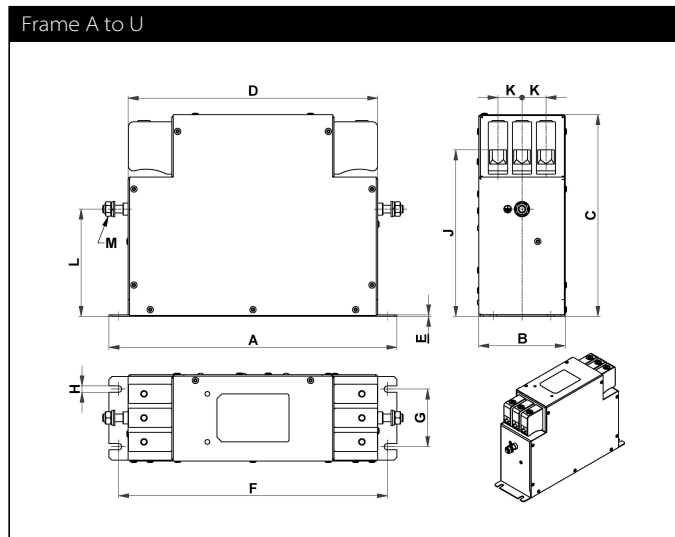

## Dimensions\*

Frame	A	B	C	D	E	F	G	H	J+/-2	K	L+/-1	M**
A	185	40	120	157	0.8	175	20	4.5	102	11	76	M5
B	195	45	140	164	0.8	180	25	5.4	122	11	93	M5
C	210	45	145	174	0.8	195	25	5.4	126	13	96	M5
D	235	50	168	207	1.0	220	30	5.4	149	13	115	M6
E	255	65	180	226	1.0	240	45	5.4	156	16	120	M6
F	230	80	205	250	1.2	270	50	6.5	172	22	110	M6
G	230	90	210	260	1.5	280	60	6.5	173	25	112	M8
H	230	100	225	270	1.5	290	70	6.5	183	28	110	M10
I	230	50	132	203	0.8	220	30	4.5	114	12.5	88	M5
J	230	55	159	198	0.8	215	35	5.4	141	13	112	M5
K	245	55	167	212	0.8	230	35	5.4	148	13	118	M5
L	265	60	191	237	1.0	250	40	5.4	172	13	135	M6
M	265	70	194	237	1.0	250	50	5.4	170	16	133	M6
N	310	95	220	270	1.2	290	65	6.5	187	22	125	M6
O	320	95	230	280	1.5	300	65	6.5	192	25	127	M8
P	330	100	240	209	1.5	310	70	6.5	198	30	127	M10
Q	180	40	112	153	0.8	170	20	4.5	94	11	68	M5
R	200	45	112	170	0.8	185	25	5.4	102	11	76	M5
S	205	45	132	173	0.8	190	25	5.4	113	13	83	M5
T	215	50	147	185	1.0	200	30	5.4	128	13	95	M6
U	220	65	180	186	1.0	205	45	5.4	156	16	120	M6

\* All dimensions in mm. For dimensions without stated tolerances: ISO 2768-m/EN 22768-m

\*\* Earth screw torque: M5 2.0-2.2 Nm; M6 3.5-4.0 Nm; M8 8.0-9.0 Nm; M10 15-17 Nm

## Filter input/output connector cross sections

	-44	-33	-53	-34	-35	-40
<b>Solid wire</b>	0.5-10 mm <sup>2</sup>	0.5-16 mm <sup>2</sup>	0.5-16 mm <sup>2</sup>	6-35 mm <sup>2</sup>	10-50 mm <sup>2</sup>	25-95 mm <sup>2</sup>
<b>Flex wire</b>	0.5-6 mm <sup>2</sup>	0.5-10 mm <sup>2</sup>	0.5-16 mm <sup>2</sup>	6-25 mm <sup>2</sup>	10-16 mm <sup>2</sup>	25-95 mm <sup>2</sup>
<b>Flex wire AWG</b>	AWG 20-8	AWG 22-6	AWG 20-4	AWG 10-2	AWG 6-1/0	AWG 0-4/0
<b>Recommended torque</b>	1.0-1.2 Nm	1.5-1.8 Nm	2.0-2.3 Nm	4.0-4.5 Nm	7.0-8.0 Nm	17-20 Nm

Please visit [www.schaffner.com](http://www.schaffner.com) to find more details on filter connectors.



## Headquarters, global innovation and development

### Switzerland

#### Schaffner Group

Nordstrasse 11  
4542 Luterbach  
T +41 32 681 66 26  
[info@schaffner.com](mailto:info@schaffner.com)  
[www.schaffner.com](http://www.schaffner.com)



## Sales and application centers

### China

#### Schaffner EMC Ltd. Shanghai

T20-3 C, No 565 Chuangye Road,  
Pudong district  
201201 Shanghai  
T +86 21 3813 9500  
[cschina@schaffner.com](mailto:cschina@schaffner.com)  
[www.schaffner.com.cn](http://www.schaffner.com.cn)

### Finland

#### Schaffner Oy

Sauvonrinne 19 H  
08500 Lohja  
T +358 50 468 7284  
[finlandsales@schaffner.com](mailto:finlandsales@schaffner.com)

### France

#### Schaffner EMC S.A.S.

16-20 Rue Louis Rameau  
95875 Bezons  
T +33 1 34 34 30 60  
F +33 1 39 47 02 28  
[francesales@schaffner.com](mailto:francesales@schaffner.com)

### Germany

#### Schaffner Deutschland GmbH

Schoemperlenstrasse 12B  
76185 Karlsruhe  
T +49 721 56910  
F +49 721 569110  
[germanysales@schaffner.com](mailto:germanysales@schaffner.com)

### India

#### Schaffner India Pvt. Ltd

REGUS WORLD TRADE CENTRE  
WTC, 22nd Floor Unit No 2238, Brigade  
Gateway Campus, 26/1, Dr. Rajkumar Road  
Malleswaram (W)  
560055 Bangalore  
T +91 80 67935355  
[indiasales@schaffner.com](mailto:indiasales@schaffner.com)

### Italy

#### Schaffner EMC S.r.l.

Via Ticino, 30  
20900 Monza (MB)  
T +39 039 21 41 070  
[italysales@schaffner.com](mailto:italysales@schaffner.com)

### Japan

#### Schaffner EMC K.K.

1-32-12, Kamiyama, Setagaya-ku  
7F Mitsui-seimei Sangenjaya Bldg.  
154-0011 Tokyo  
T +81 3 5712 3650  
F +81 3 5712 3651  
[japansales@schaffner.com](mailto:japansales@schaffner.com)  
[www.schaffner.jp](http://www.schaffner.jp)

### Singapore

#### Schaffner EMC Pte Ltd.

#05-09, Kg Ubi Ind. Estate  
408705 Singapore  
T +65 6377 3283  
F +65 6377 3281  
[singaporesales@schaffner.com](mailto:singaporesales@schaffner.com)

### Spain

#### Schaffner EMC España

Calle Caléndula 93, Miniparc III, Edificio E  
El Soto de Moraleja, Alcobendas  
28109 Madrid  
T +34 917 912 900  
F +34 917 912 901  
[spainsales@schaffner.com](mailto:spainsales@schaffner.com)

### Sweden

#### Schaffner EMC AB

Tegeluddsvägen 76, 2tr  
115 28 Stockholm  
T +46 8 5050 2425  
[swedensales@schaffner.com](mailto:swedensales@schaffner.com)  
[www.schaffner.com](http://www.schaffner.com)

### Switzerland

#### Schaffner EMV AG

Nordstrasse 11  
4542 Luterbach  
T +41 32 681 66 26  
[switzerlandsales@schaffner.com](mailto:switzerlandsales@schaffner.com)

### Taiwan R.O.C.

#### Schaffner EMV Ltd.

20 Floor-2, No 97, Section 1, XinTai 5th Road  
22175 XiZhi District New Taipei City 22175  
T +886 2 2697 5500  
F +886 2 2697 5533  
[taiwansales@schaffner.com](mailto:taiwansales@schaffner.com)  
[www.schaffner.com.tw](http://www.schaffner.com.tw)

### Thailand

#### Schaffner EMC Co. Ltd.

Northern Region Industrial Estate  
67 Moo 4 Tambon Ban Klang  
Amphur Muangng P.O. Box 14  
51000 Lamphun  
T +66 53 58 11 04  
F +66 53 58 10 19  
[thailandsales@schaffner.com](mailto:thailandsales@schaffner.com)

### United Kingdom

#### Schaffner Ltd.

5 Ashville Way, Molly Millars Lane  
Wokingham  
RG41 2PL Berkshire  
T +44 118 9770070  
F +44 118 9792969  
[uksales@schaffner.com](mailto:uksales@schaffner.com)

### USA

#### Schaffner EMC Inc.

52 Mayfield Avenue  
08837 Edison, New Jersey  
T +1 800 367 5566  
T +1 732 225 9533  
F +1 732 225 4789  
[usasales@schaffner.com](mailto:usasales@schaffner.com)  
[www.schaffnerusa.com](http://www.schaffnerusa.com)

#### Schaffner North America

6722 Thirlane Road  
24019 Roanoke, Virginia  
T +1 276 228 7943  
F +1 276 228 7953

#### Schaffner North America

823 Fairview Road  
24382 Wytheville, Virginia  
T +1 276 228 7943  
F +1 276 228 7258

To find your local partner within Schaffner's global network: [www.schaffner.com](http://www.schaffner.com)

© 2018 Schaffner Group

The content of this document has been carefully checked and understood. However, neither Schaffner nor its subsidiaries assume any liability whatsoever for any errors or inaccuracies of this document and the consequences thereof. Published specifications are subject to change without notice. Product suitability for any area of application must ultimately be determined by the customer. In all cases, products must never be operated outside their published specifications. Schaffner does not guarantee the availability of all published products. This disclaimer shall be governed by substantive Swiss law and resulting disputes shall be settled by the courts at the place of business of Schaffner Holding AG. Latest publications and a complete disclaimer can be downloaded from the Schaffner website. All trademarks recognized.