

Time-of-Flight high accuracy proximity sensor

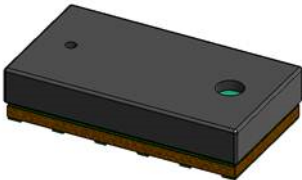

Features

High accuracy proximity ranging

- High performance proximity sensor
- From 0 to 1300 mm with full field of view (FoV)
- Short distance linearity down to 1 mm
- FoV of 18°
- Autonomous low power mode with programmable interrupt threshold to wake up the host
- Fast ranging frequency up to 100 Hz

Fully integrated miniature module

- 940 nm invisible laser emitter (VCSEL) and analog driver
- Low power microcontroller running advanced digital Firmware
- 4.4 x 2.4 x 1 mm size
- Pin-to-pin compatible with VL53L0X, VL53L1X, VL53L1CB, VL53L3CX and VL53L4CX

Easy integration

- Reflowable component
- Single power supply 2v8
- Can be hidden behind cover glass
- I²C interface (up to 1 MHz)
- Full set of C software drivers (Linux compatible) for turnkey ranging
- Embedded processing for very low memory footprint in the host

Product status link

[VL53L4CD](#)

Applications

- Proximity ranging applications such as:
 - Wall tracking and cliff detection for robotics
 - System activation and presence detection
 - Touchless switch
- Very low power consumption for battery powered devices including:
 - Access control
 - Sanitary (faucets, dispensers, etc.)
 - Home appliances (thermostats, lighting control, etc.)
- Fast ranging
 - Bar code readers
 - Biometric distance applications
 - Virtual fences

Description

Specifically designed for proximity and short-range measurements, the VL53L4CD provides very accurate distance measurements from only 1 mm up to 1300 mm. A new generation laser emitter with 18° FoV improves performances under ambient light, with ranging speed up to 100 Hz.

With very low power consumption thanks to an Autonomous mode with programmable distance threshold, the VL53L4CD is ideal for use in battery powered devices. Its fully embedded on-chip processing helps to reduce design complexity as well as BOM cost since less powerful and less expensive microcontrollers can be used.

Like all Time-of-Flight (ToF) sensors based on ST's FlightSense technology, the VL53L4CD records an absolute distance measurement regardless of the target color and reflectance.

Housed in a miniature reflowable package, which integrates a SPAD (single photon avalanche diode) array, the VL53L4CD achieves the best ranging performance in various ambient lighting conditions and for a wide range of cover glass materials.

All of ST's ToF sensors integrate a VCSEL (vertical cavity surface emitting laser). It emits a fully invisible 940 nm IR light that is totally safe for eyes (Class 1 certification).

1 Product overview

1.1 Technical specification

Table 1. Technical specification

Feature	Detail
Package	Optical LGA12
Size	4.4 x 2.4 x 1 mm
Operating voltage	2.6 to 3.5 V
Operating temperature	-30 to 85°C
Infrared emitter	940 nm
I2C	Up to 1 MHz (Fast mode plus) serial bus Address: 0x52

1.2 System block diagram

Figure 1. VL53L4CD block diagram

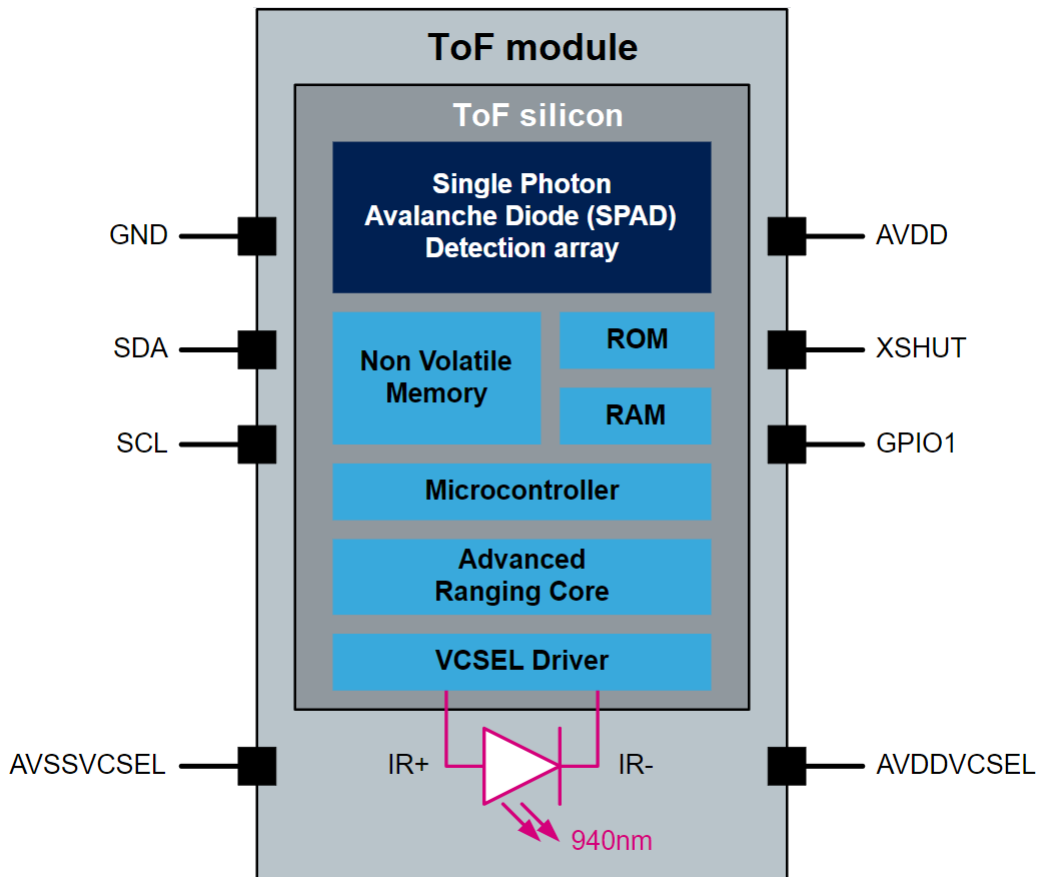

1.3 Device pinout

The following figure shows the pinout of the VL53L4CD (see also [Section 6 Outline drawings](#)).

Figure 2. VL53L4CD pinout (bottom view)

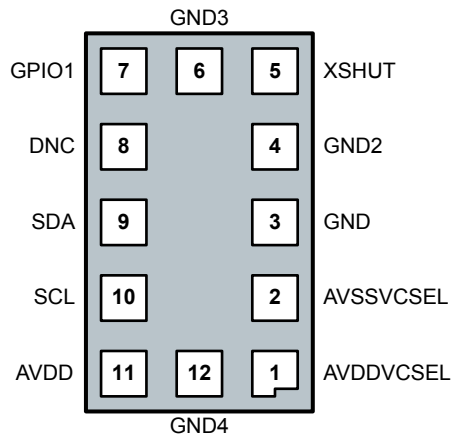

Table 2. VL53L4CD pin description

Pin number	Signal name	Signal type	Signal description
1	AVDDVCSEL	Supply	VCSEL supply, to be connected to main supply
2	AVSSVCSEL	Ground	VCSEL ground, to be connected to main ground
3	GND		To be connected to main ground
4	GND2		
5	XSHUT		Digital input
6	GND3	Ground	To be connected to main ground
7	GPIO1	Digital output	Interrupt output. Open drain output
8	DNC	Digital input	Do not connect, must be left floating
9	SDA	Digital input/output	I2C serial data
10	SCL	Digital input	I2C serial clock input
11	AVDD	Supply	Supply, to be connected to main supply
12	GND4	Ground	To be connected to main ground

Note: AVSSVCSEL and GND are ground pins and can be connected together in the application schematics.

Note: GND2, GND3, and GND4 are standard pins that are forced to the ground domain in the application schematics to avoid possible instabilities if set to other states.

Table 4. Suggested pull up and series resistors for I2C Fast mode plus

I2C load capacitance (CL) ⁽¹⁾	Pull up resistor (Ohms)	Series resistor (Ohms)
$C_L \leq 90 \text{ pF}$	1.5 k	100
$90 \text{ pF} < C_L \leq 140 \text{ pF}$	1 k	50
$140 \text{ pF} < C_L \leq 270 \text{ pF}$	0.5 k	50
$270 \text{ pF} < C_L \leq 400 \text{ pF}$	0.3 k	50

1. For each bus line, CL is measured in application PCB by customer.

2 Functional description

2.1 System functional description

Figure 4. VL53L4CD system functional description shows the system level functional description.

The host customer application controls the VL53L4CD device using a driver called Ultra Lite Driver (ULD). The ULD contains a set of high level functions that allow control of the VL53L4CD Firmware (FW), like initialization, ranging start/stop, setting the system accuracy.

The driver is a turnkey solution consisting of a set of “C” functions that enable fast development of end user applications without the complication of direct multiple register access. The driver is structured in a way that it can be compiled on any kind of platform through a well abstracted platform layer. The driver package allows the user to take full advantage of the VL53L4CD capabilities.

A detailed description of the driver is available in the user manual (UM2931).

The FW fully manages the hardware (HW) registers access.

Section 2.2 State machine description details the Firmware state machine.

Figure 4. VL53L4CD system functional description

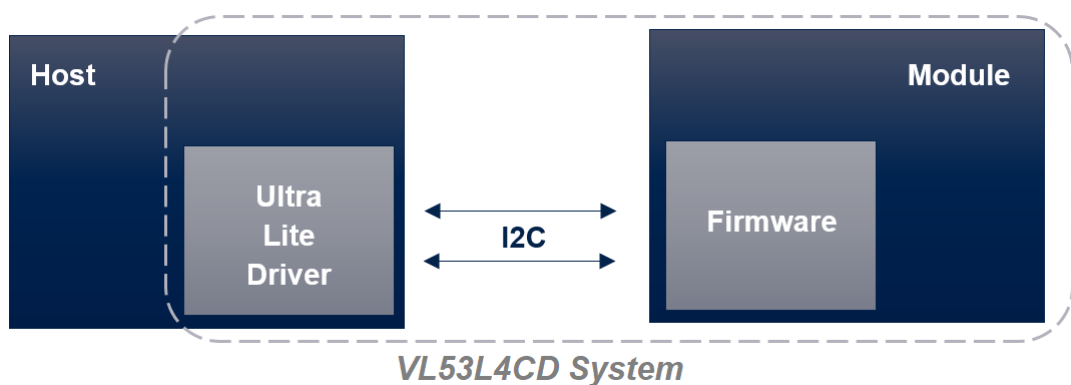

2.2 State machine description

The following figure shows the device state machine.

Figure 5. Device state machine

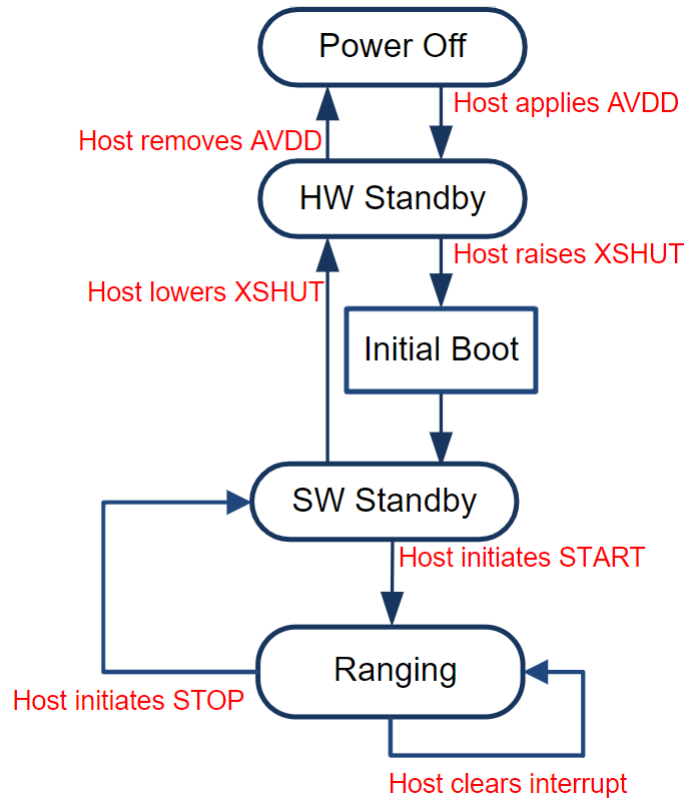

2.3 Customer manufacturing calibration flow

Up to two calibrations are needed to ensure the best sensor performances. Offset needed in all applications. If a cover glass is used, cross-talk calibration is needed also.

The detailed procedure is provided in the VL53L4CD Ultra Lite Driver user manual (UM2931).

2.4 Device programming and control

The device physical control interface is I2C, described in [Section 3 Control interface](#).

A software layer (driver) is provided to control the device. This avoids complex I2C register operations with turnkey functions to start, stop and read the ranging values.

The driver structure and functions are described in the VL53L4CD Ultra Lite Driver user manual.

2.5 Digital processing and reading the results

Digital processing is the final operation of the ranging sequence that computes, validates or rejects a ranging measurement. All the processing is performed by the VL53L4CD internal firmware. The software driver allows reading the results when they are valid.

If the distance cannot be measured (no target or weak signal), a corresponding status error code is generated and can be read by the host.

A full description of the status errors is provided in the VL53L4CD Ultra Lite Driver user manual (UM2931).

2.6 Reading the results

The software driver provides turnkey functions to read output results after the measurement:

- Signal rate
- Ranging distance
- Measurement status

A full description is provided in the VL53L4CD Ultra Lite Driver user manual (UM2931).

2.7 Power sequence

There are two options available for device power up and boot sequence.

Note: In all cases, XSHUT has to be raised only when AVDD is tied on.

Option 1

The XSHUT pin is connected and controlled from the host.

This option optimizes power consumption as the device can be completely powered off when not used, and then woken up through the host (using the XSHUT pin).

HW Standby mode is the period when AVDD is present and XSHUT is low.

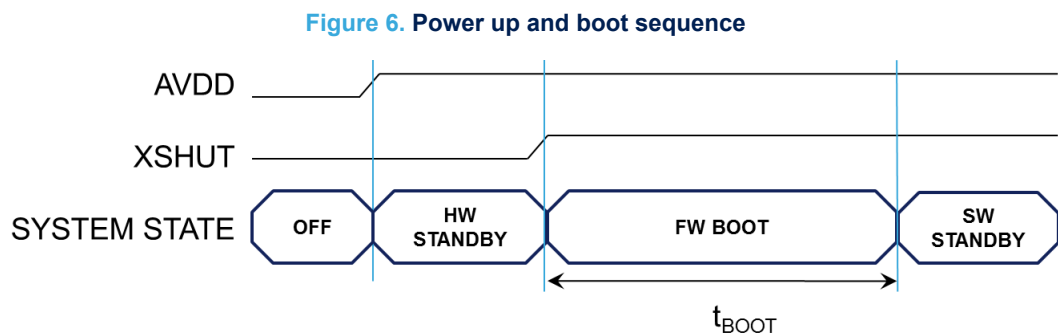

Note: t_{BOOT} is 1.2 ms maximum.

Option 2

The XSHUT pin is not controlled by the host; it is tied to AVDD through the pull up resistor.

When the XSHUT pin is not controlled, the power-up sequence is presented in the following figure. In this case, the device goes automatically to SW STANDBY after FW BOOT, without entering HW STANDBY.

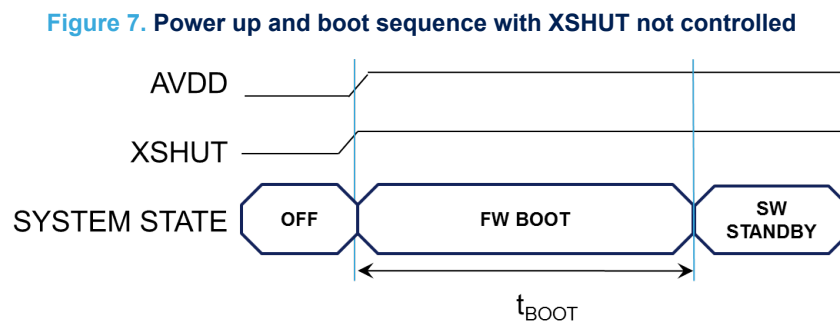

Note: t_{BOOT} is 1.2 ms maximum.

2.8 Ranging sequence

Figure 8. Ranging sequence

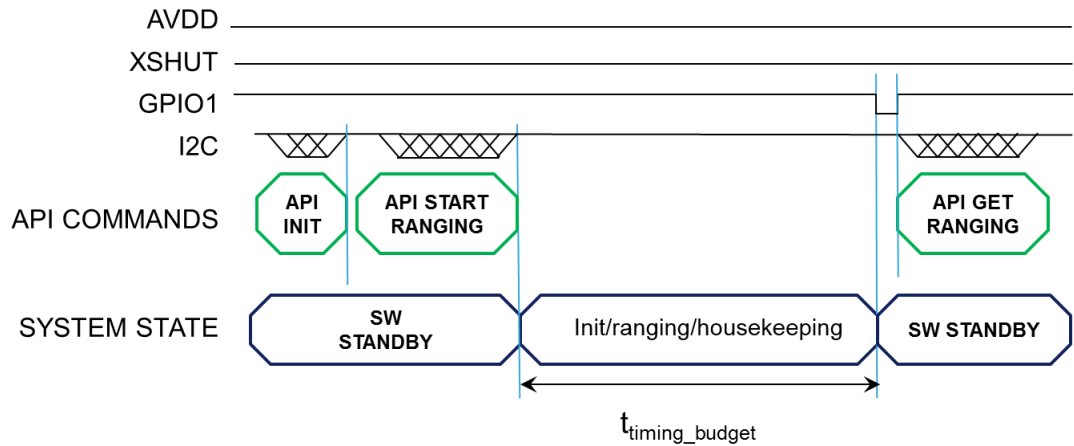

Note: API in the figure above means application programmable interface.

Note: $t_{\text{timing_budget}}$ is a parameter set by the user, using a dedicated driver function.

2.9 Handshake management

Once a ranging measurement is available, an interrupt is generated. This is communicated to the host as a physical signal on the GPIO1 pin, which is driven low, and the output of a driver function. The former operating method is called “hardware interrupt”, and the latter is referred to as “polling mode”.

Once the host reads the result, the interrupt is cleared by the driver and the ranging sequence can continue. If the interrupt is not cleared, the ranging operation inside the device is on hold. The interrupt behavior allows a good synchronization between the device and the host, which avoids losing results if the host is not available to acquire or process the data.

It is strongly recommended to use the hardware interrupt pin to manage this handshake.

For more details refer to VL53L4CD Ultra Lite Driver user manual.

3 Control interface

This section specifies the control interface. The I2C interface uses two signals: serial data line (SDA) and serial clock line (SCL). Each device connected to the bus uses a unique address and a simple master / slave relationship exists.

Both SDA and SCL lines are connected to a positive supply voltage using pull-up resistors located on the host. Lines are only actively driven low. A high condition occurs when lines are floating and the pull up resistors pull lines up. When no data is transmitted both lines are high.

Clock signal generation is performed by the master device. The master device initiates data transfer. The I2C bus has a maximum speed of 1 Mbits/s and uses a default device address of 0x52.

Figure 9. Data transfer protocol

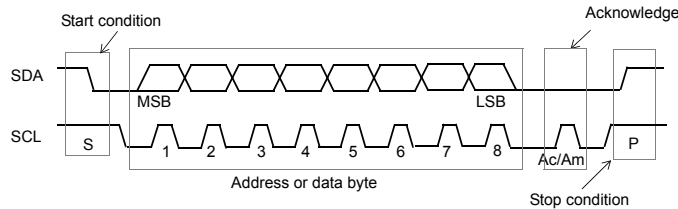

Information is packed in 8 bit packets (bytes) and is always followed by an acknowledge bit, Ac for VL53L4CD acknowledge and Am for master acknowledge (host bus master). The internal data is produced by sampling SDA at a rising edge of SCL. The external data must be stable during the high period of SCL. The exceptions to this are start (S) or stop (P) conditions when SDA falls or rises respectively, while SCL is high.

A message contains a series of bytes preceded by a start condition and followed by either a stop or repeated start (another start condition but without a preceding stop condition) followed by another message. The first byte contains the device address (0x52) and also specifies the data direction. If the least significant bit is low (that is, 0x52) the message is a master-write-to-the-slave. If the LSB is set (that is, 0x53) then the message is a master-read-from-the-slave.

Figure 10. I2C device address: 0x52

MSBit							LSBit
0	1	0	1	0	0	1	R/W

All serial interface communications with the Time-of-Flight sensor must begin with a start condition. The VL53L4CD module acknowledges the receipt of a valid address by driving the SDA wire low. The state of the read/write bit (LSB of the address byte) is stored and the next byte of data, sampled from SDA, can be interpreted. During a write sequence, the second byte received provides a 16 bit index which points to one of the internal 8 bit registers.

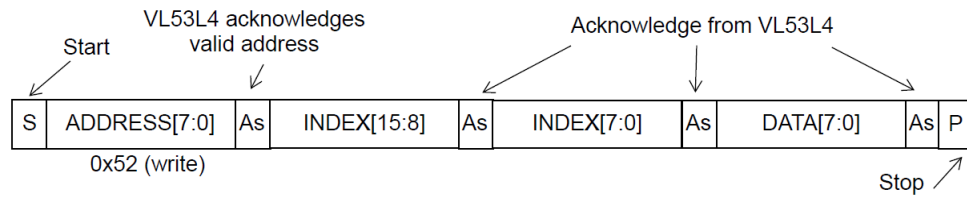
Figure 11. Data format (write)

As data are received by the slave, they are written bit by bit to a serial/parallel register. After each data byte has been received by the slave, an acknowledge is generated, the data are then stored in the internal register addressed by the current index.

During a read message, the contents of the register addressed by the current index is read out in the byte following the device address byte. The contents of this register are parallel loaded into the serial/parallel register and clocked out of the device by the falling edge of SCL.

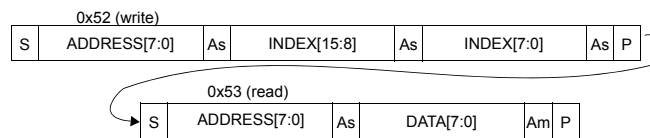
Figure 12. Data format (read)

At the end of each byte, in both read and write message sequences, an acknowledge is issued by the receiving device (that is, the VL53L4CD for a write and the host for a read).

A message can only be terminated by the bus master, either by issuing a stop condition or by a negative acknowledge (that is, not pulling the SDA line low) after reading a complete byte during a read operation.

The interface also supports auto increment indexing. After the first data byte has been transferred, the index is automatically incremented by 1. The master can therefore send data bytes continuously to the slave until the slave fails to provide an acknowledge or the master terminates the write communication with a stop condition. If the auto increment feature is used the master does not have to send address indexes to accompany the data bytes.

Figure 13. Data format (sequential write)

Figure 14. Data format (sequential read)



3.1 I2C interface - timing characteristics

Timing characteristics are shown in the following tables. Refer to [Figure 15. I2C timing characteristics](#) for an explanation of the parameters used.

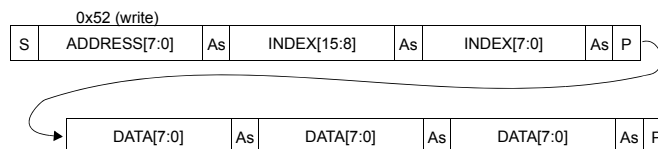
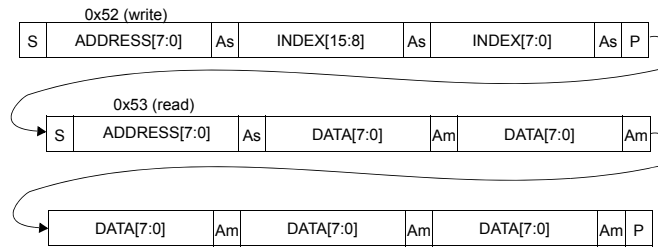
Timings are given for all PVT conditions

Table 5. I2C interface - timing characteristics for Fast mode plus (1 MHz)

Symbol	Parameter	Minimum	Typical	Maximum	Unit
F _{I2C}	Operating frequency	0	-	1000	kHz
t _{LOW}	Clock pulse width low	0.5	-	-	μs
t _{HIGH}	Clock pulse width high	0.26	-	-	
t _{SP}	Pulse width of spikes which are suppressed by the input filter	-	-	50	ns
t _{BUF}	Bus free time between transmissions	0.5	-	-	μs
t _{HD.STA}	Start hold time	0.26	-	-	
t _{SU.STA}	Start setup time	0.26	-	-	
t _{HD.DAT}	Data in hold time	0	-	0.9	
t _{SU.DAT}	Data in setup time	50	-	-	ns
t _R	SCL/SDA rise time - -	-	-	120	
t _F	SCL/SDA fall time	-	-	120	
t _{SU.STO}	Stop set-up time	0.26	-	-	μs
C _{i/o}	Input/output capacitance (SDA)	-	-	10	pF
C _{in}	Input capacitance (SCL)	-	-	4	
C _L	Load capacitance	-	140	550	

Table 6. I2C interface - timing characteristics for Fast mode (400 kHz)

Symbol	Parameter	Minimum	Typical	Maximum	Unit
F_{I2C}	Operating frequency	0	-	400	kHz
t_{LOW}	Clock pulse width low	1.3	-	-	μs
t_{HIGH}	Clock pulse width high	0.6	-	-	
t_{SP}	Pulse width of spikes which are suppressed by the input filter	-	-	50	ns
t_{BUF}	Bus free time between transmissions	1.3	-	-	μs
$t_{HD.STA}$	Start hold time	0.26	-	-	
$t_{SU.STA}$	Start setup time	0.26	-	-	
$t_{HD.DAT}$	Data in hold time	0	-	0.9	
$t_{SU.DAT}$	Data in setup time	50	-	-	ns
t_R	SCL/SDA rise time - -	-	-	300	
t_F	SCL/SDA fall time	-	-	300	
$t_{SU.STO}$	Stop set-up time	0.6	-	-	μs
$C_{i/o}$	Input/output capacitance (SDA)	-	-	10	pF
C_{in}	Input capacitance (SCL)	-	-	4	
C_L	Load capacitance	-	125	400	

Figure 15. I2C timing characteristics

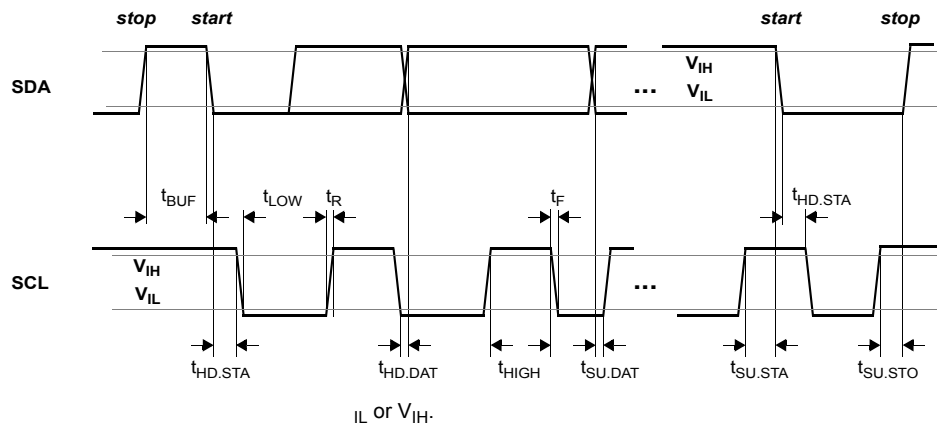

All timings are measured from either V_{IL} or V_{IH}.

3.2 I2C interface - reference registers

The registers shown in the table below can be used to validate the user I2C interface.

Table 7. Reference registers

Register name	Index	Value
Model_ID	0x010F	0xEB
Module_Type	0x0110	0xAA

Note:

The I2C read/writes can be 8, 16 or 32-bit. Multi-byte reads/writes are always addressed in ascending order with MSB first as shown in the following table.

The customer must use the VL53L4CD software driver for easy and efficient ranging operations to match performance and accuracy criteria. Hence full register details are not exposed. The customer should refer to the VL53L4CD Ultra Lite Driver user manual.

Table 8. 32-bit register example

Register address	Byte
Address	MSB
Address + 1	-
Address + 2	-
Address + 3	LSB

4 Electrical characteristics

4.1 Absolute maximum ratings

Warning:

Stresses above those listed in the following table may cause permanent damage to the device. This is a stress rating only and functional operation of the device at these or any other conditions above those indicated in the operational sections of the specification is not implied. Exposure to absolute maximum rating conditions for extended periods may affect device reliability.

Table 9. Absolute maximum ratings

Parameter	Min.	Typ.	Max.	Unit
AVDD	-0.5	-	3.6	V
SCL, SDA, XSHUT and GPIO1				

4.2 Recommended operating conditions

There are no power supply sequencing requirements. The I/Os may be high, low or floating when AVDD is applied. The I/Os are internally failsafe with no diode connecting them to AVDD.

Table 10. Recommended operating conditions

There are no power supply sequencing requirements. The I/Os may be high, low or floating when AVDD is applied. The I/Os are internally failsafe with no diode connecting them to AVDD.

Parameter	Min.	Typ.	Max.	Unit
Voltage (AVDD)	2.6	2.8	3.5	V
IO (IOVDD) ⁽¹⁾	1.6	1.8/2.8	3.5	
Ambient operating temperature range without damage ⁽²⁾	-30	—	85	°C

1. XSHUT should be high level only when AVDD is on
2. Performances described in the datasheet are given under 23deg ambient temperature

4.3 ESD

The VL53L4CD is compliant with ESD values presented in the following table.

Table 11. ESD performances

Parameter	Specification	Conditions
Human body model	JS-001-2012	± 2 kV, 1500 Ohms, 100 pF
Charged device model	JESD22-C101	± 500 V

4.4 Current consumption

Table 12. Power consumption at ambient temperature

All current consumption values include silicon process variations. Temperature and voltage are nominal conditions (23°C and 2v8). All values include AVDD and AVDDVCSEL.

Parameter	Min.	Typ.	Max.	Unit
HW STANDBY	3	5	7	μA
SW STANDBY	4	6	9	
Active ranging average consumption (including VCSEL) ^{(1) (2)}		22	24	mA

- Active ranging is an average value, measured using default driver settings.
- Peak current (including VCSEL) can reach 40 mA

4.5 Digital input and output

Table 13. Digital I/O electrical characteristics

Symbol	Parameter	Min.	Typ.	Max.	Unit
Interrupt pin (GPIO1)					
VIL	Low level input voltage	-	-	0.3 IOVDD	V
VIH	High level input voltage	0.7 IOVDD		-	
VOL	Low level output voltage (IOUT = 4 mA)	-		0.4	
VOH	High level output voltage (IOUT = 4 mA)	IOVDD-0.4		-	
FGPIO	Operating frequency (CLOAD = 20 pF)	0		108	MHz
I2C interface (SDA/SCL)					
VIL	Low level input voltage	-0.5	-	0.6	V
VIH	High level input voltage	1.12		IOVDD+0.5	
VOL	Low level output voltage (IOUT = 4 mA)	-		0.4	
IIL/IH	Leakage current ⁽¹⁾	-		10	
	Leakage current ⁽²⁾	-		0.15	μA

- AVDD = 0 V
- AVDD = 2.85 V; I/O voltage = 1.8 V

5 Ranging performances

5.1 Measurement conditions

In all the measurement tables of this document, it is considered that:

- All ranging performances are measured with the target covering the full FoV.
- Charts used as targets are: gray (17% reflectance, N4.74 Munsell) and white (88% reflectance N9.5 Munsell).
- Nominal voltage is 2.8 V and temperature is 23°C.
- The device is controlled through the driver using the default settings (refer to the user manual for driver settings description).
- Indoor (no IR) means there is no contribution of light in the band 940 nm ± 30 nm
- Outdoor overcast corresponds to an ambient light level of 10 kcps/SPAD. For reference, this corresponds to a 1.2 W/m² at 940 nm following the AM1.5G spectrum and is equivalent to 5 kLux daylight as reflected by a gray 17% chart at 40 cm.
- No cover glass is present.
- Typical samples are used.
- Offset correction made at 100 mm from sensor with gray 17% target.

5.2 Minimum ranging distance

The minimum detection distance is 0 mm. The minimum ranging distance with a linear response is 1 mm.

5.3 Maximum ranging distance

The following table shows the ranging specification for the VL53L4CD bare module, without cover glass, at room temperature (23°C), with nominal voltage (2.8 V) and full FoV covered.

Table 14. Max. ranging capabilities with 33 ms timing budget

Target reflectance level, full FoV (reflectance %)	Indoor (detection rate %)	Outdoor overcast (detection rate %)
White target (88%)	Typical: 1200 mm @ 90% min Typical: 1300 mm @ 50% min	Typical: 550 mm @ 90% min Typical: 600 mm @ 50% min
Gray target (17%)	Typical: 450 mm @ 90% min Typical: 475 mm @ 50% min	Typical: 400 mm @ 90% min Typical: 450 mm @ 50% min

Detection rate is a statistical value indicating the worst case percentage of measurements that return a valid ranging. For example, taking 1000 measurements with 90% detection rate will give 900 valid distances. The 100 other distances may be outside of the specification and are flagged with an error status.

5.4 Ranging accuracy

The figure below illustrates how range accuracy is defined over distance.

Figure 16. Ranging accuracy vs. distance

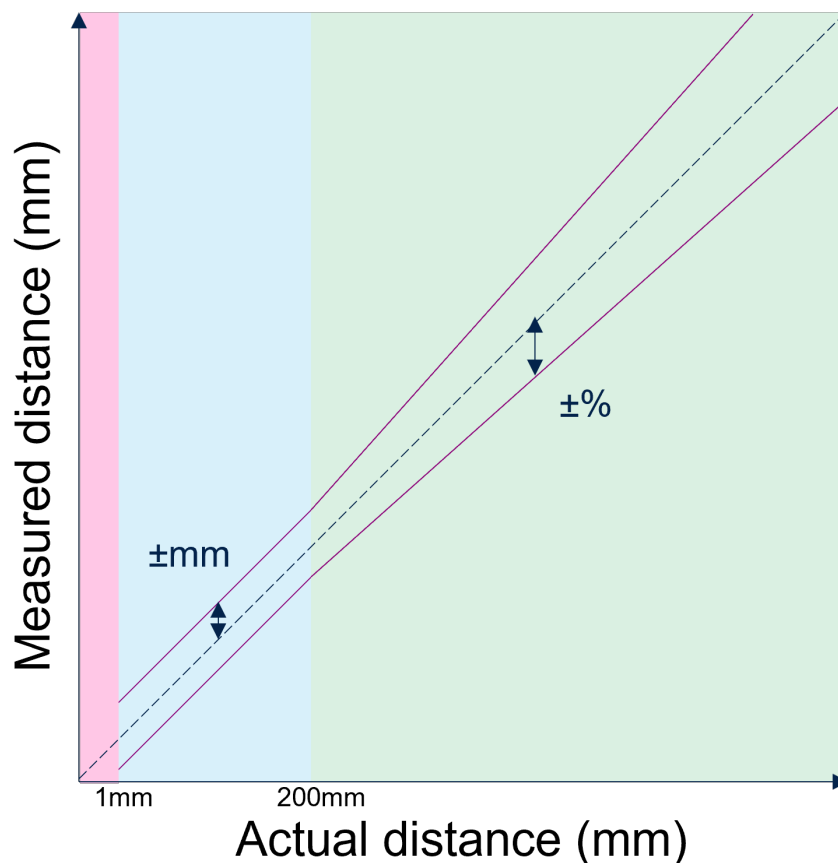

The ranging accuracy is a direct evaluation of the measurement error, including offset errors and output noise. At least 90% of the ranging values are within the declared ranges. This quality indicator includes measure-to-measure and part-to-part dispersion.

Table 15. Typical ranging accuracy with 33 ms timing budget

Target reflectance level, full FoV	Distance (mm)	Indoor (no infrared)	Outdoor overcast
White target (88%)	1-100	± 7 mm	± 8 mm
	101-200	± 8 mm	± 9 mm
	>200	± 3%	± 8%
Gray target (17%)	1-100	± 6 mm	± 7 mm
	101-200	± 8 mm	± 9 mm
	>200	± 4%	± 8%

5.5 Ranging drift with temperature

When the temperature increases, the ranging value may be affected.

This value is an offset and not a gain, and it does not depend on the target distance.

The device embeds a feature that allows to compensate the temperature variation effect.

In order to get the most accurate performances, perform a manual temperature update when temperature varies. This operation is done using a dedicated driver function. Refer to the VL53L4CD Ultra Lite Driver user manual (UM2931).

6 Outline drawings

ST delivers any of the two alternative dual source cap assemblies as detailed in the drawings below. Both versions are transparent for the customer, since the pad and substrate design are identical for both versions and have no impact on customer PCB design. Ranging performances, reflow, and technical parameters are identical for all module designs presented in the figures below.

Figure 17. Outline drawing (page 1/4)

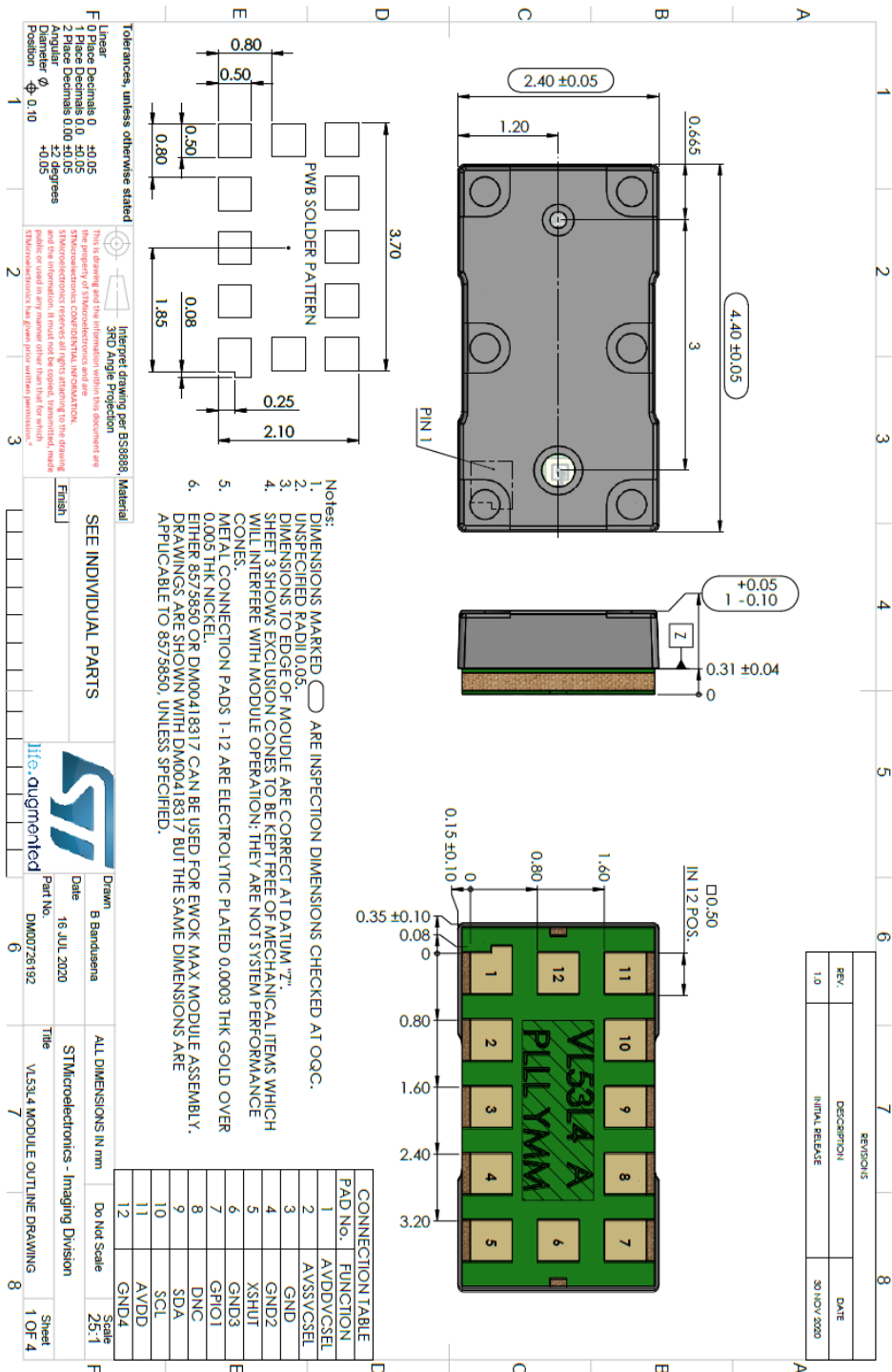

Figure 19. Outline drawing (page 3/4)

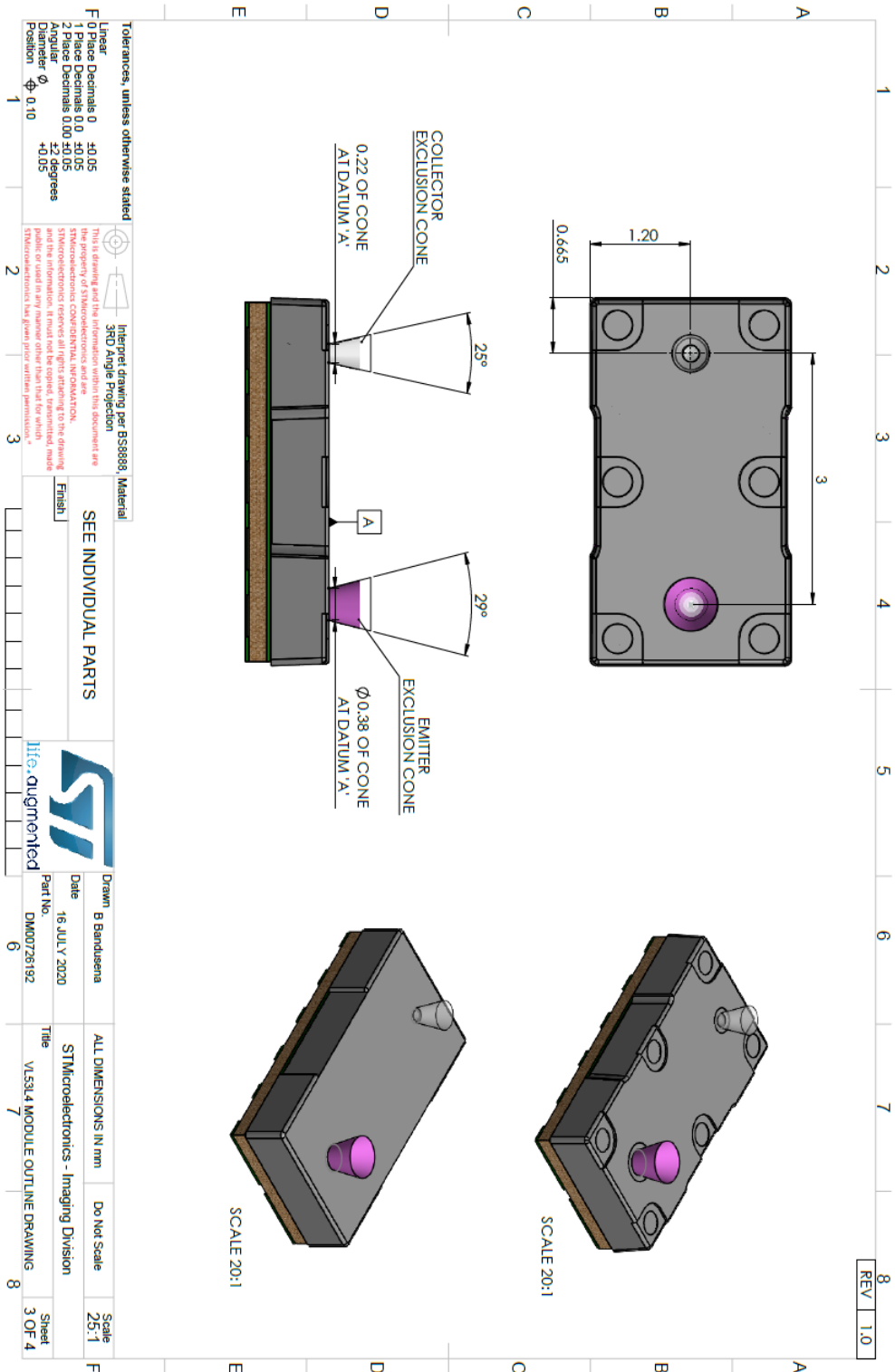
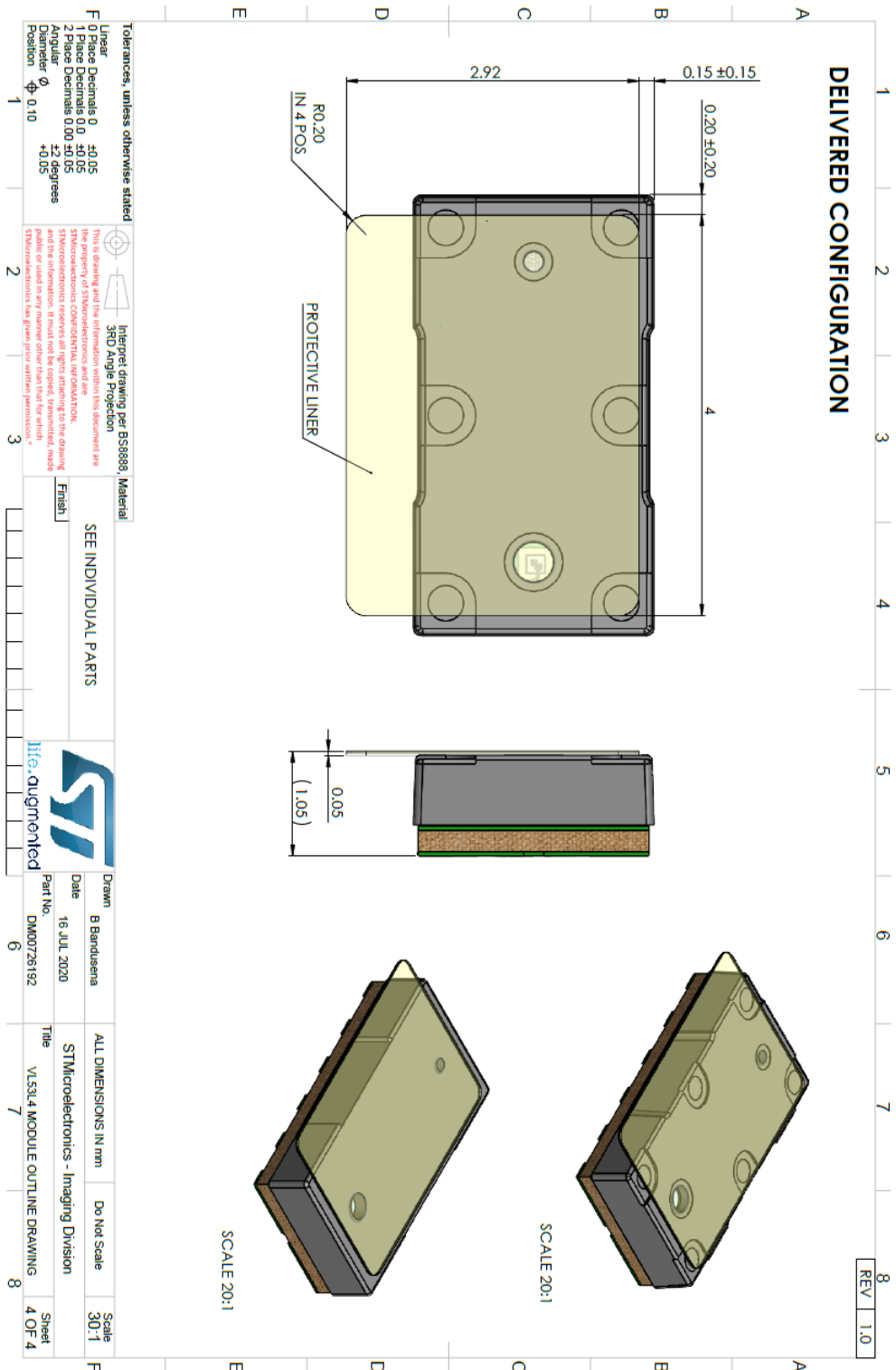

Figure 20. Outline drawing with liner (page 4/4)



7 Field of view (FoV) and field of illumination (Fol)

The Rx (or collector) exclusion zone includes all module assembly tolerances and is used to define the cover window dimensions. The cover window opening must be equal to or wider than the exclusion zone.

The detection volume represents the applicative or system FoV in which a target is detected, and a distance measured. It is determined by the Rx lens or the Rx aperture, and is narrower than the exclusion zone.

Figure 21. System FoV and exclusion zone description (not to scale)

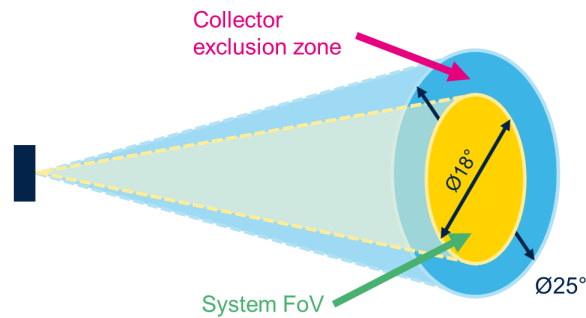

Table 16. FoV angles

Setting	Target at 100 mm (white 88%)	Target at 1000 mm (white 88%)
Detection volume (°)	22°	18°
Collector exclusion cone (°)	25°	25°

Note: Detection volume depends on the environment and sensor configuration as well as target distance, reflectance, ambient light level, sensor timing budget, distance mode, and tuning parameters.

Note: The detection volume of Table 16. FoV angles has been measured with a white 88% reflectance perpendicular target in full FoV, located at 100 mm and 1000 mm from the sensor, without ambient light (dark conditions), using the default driver configuration.

The VCSEL Fol is shown in the figure below. The X-axis is 16° and the Y-axis is 16° (1/e²).

Figure 22. VL53L4CD Fol

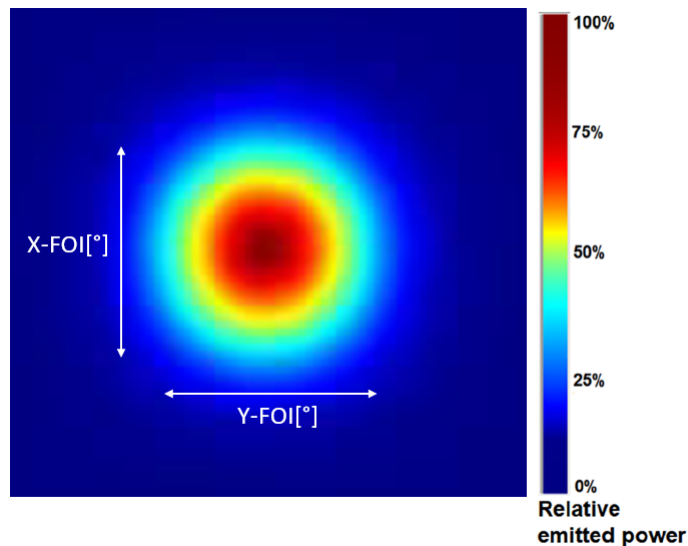

8 Laser safety considerations

The VL53L4CD contains a laser emitter and corresponding drive circuitry. The laser output is designed to remain within Class 1 laser safety limits under all reasonably foreseeable conditions including single faults in compliance with IEC 60825-1:2014 (third edition).

The laser output remains within Class 1 limits as long as STMicroelectronics's recommended device settings are used and the operating conditions specified are respected (particularly the maximum timing budget, as described in the user manual).

The laser output power must not be increased by any means and no optics should be used with the intention of focusing the laser beam.

Caution: Use of controls or adjustments or performance of procedures other than those specified herein may result in hazardous radiation exposure.

Figure 23. Class 1 laser product label

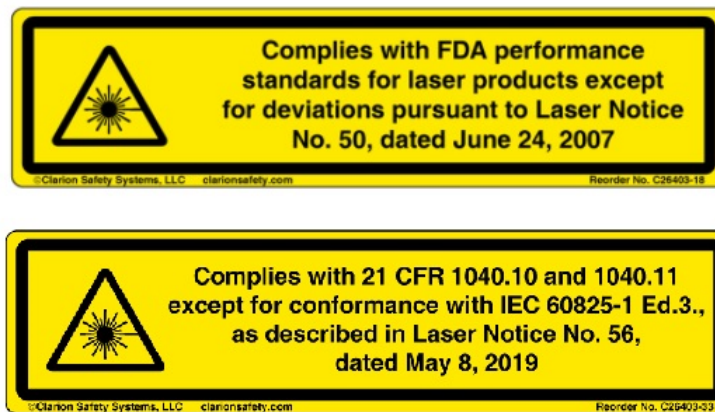

9 Packaging and labeling

9.1 Product marking

A two line product marking is applied on the backside of the module (i.e. on the substrate). The first line is the silicon product code, and the second line, the internal tracking code.

9.2 Inner box labeling

The labeling follows the ST standard packing acceptance specification.

The following information will be on the inner box label:

- Assembly site
- Sales type
- Quantity
- Trace code
- Marking
- Bulk ID number

9.3 Packing

At customer level, it is recommended to mount the VL53L4CD in a clean environment to avoid foreign material deposition.

To help avoid any foreign material contamination at product assembly level the modules is shipped in a tape and reel format. The tape is described in [Figure 24. Tape outline drawing](#).

The packaging is vacuum sealed and includes a desiccant.

9.4 Tape outline drawing

Figure 24. Tape outline drawing

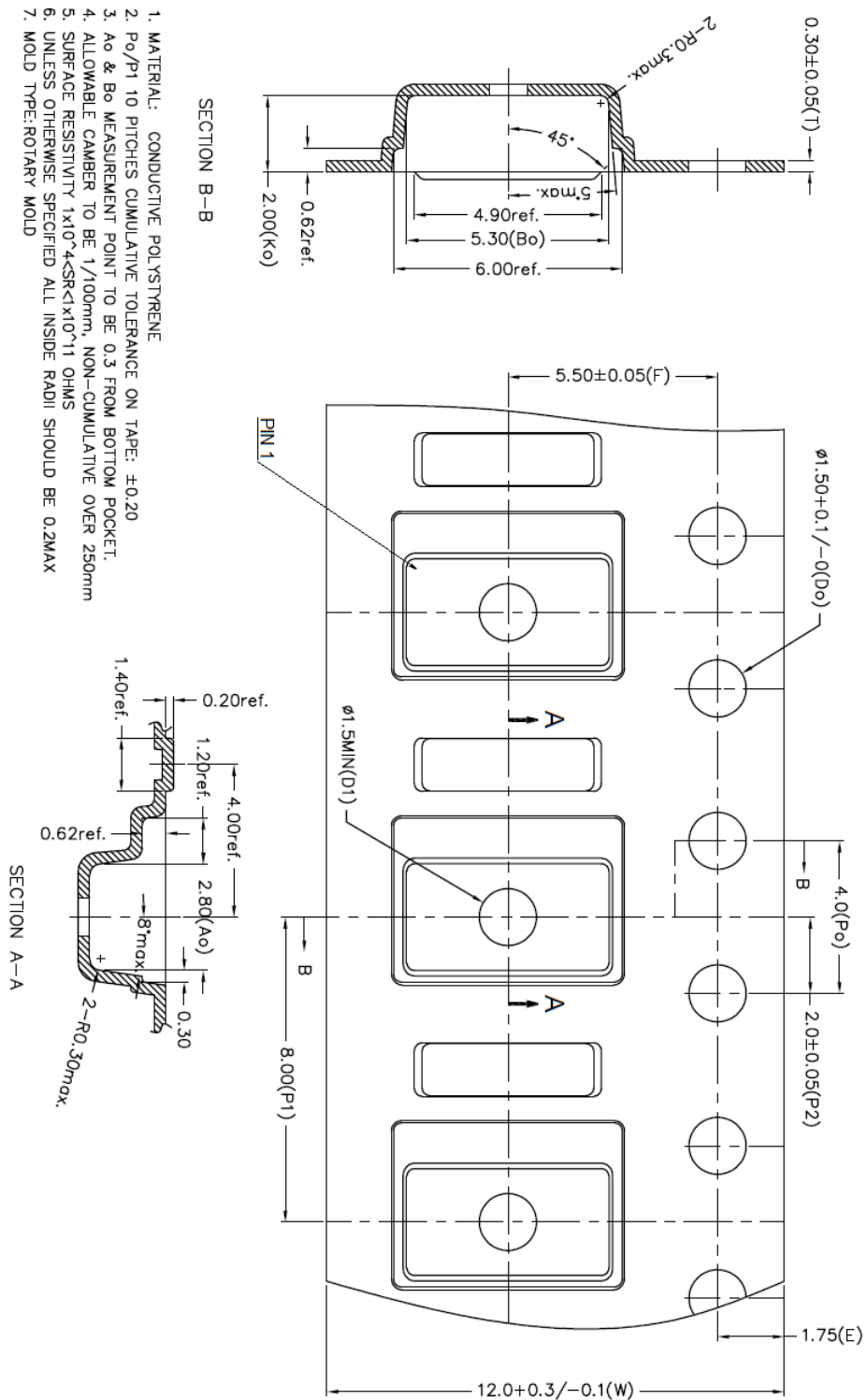

9.5 Pb-free solder reflow process

Table 17. Recommended solder profile and Figure 25. Solder profile show the recommended and maximum values for the solder profile.

Customers have to tune the reflow profile depending on the PCB, solder paste and material used. We expect customers to follow the recommended reflow profile, which is specifically tuned for package.

For any reason, if a customer must perform a reflow profile which is different from the recommended one (especially peak $>240^{\circ}\text{C}$), this new profile must be qualified by the customer at their own risk. In any case, the profile must be within the “maximum” profile limit described in the following table.

Note: Temperature mentioned in the following table are measured at the top of the package.

Table 17. Recommended solder profile

Parameters	Recommended	Maximum	Unit
Minimum temperature (TS min)	130	150	°C
Maximum temperature (TS max)	200	200	
Time ts (TS min to TS max)	90-110	60-120	s
Temperature (TL)	217	217	°C
Time (tL)	55-65	55-65	s
Ramp up	2	3	°C/s
Temperature (Tp-10)	-	250	°C
Time (tp-10)		10	s
Ramp up		3	°C/s
Peak temperature (Tp)	240	260 max	°C
Time to peak	30	300	s
Ramp down (peak to Tl)	-4	-6	°C/s

Figure 25. Solder profile

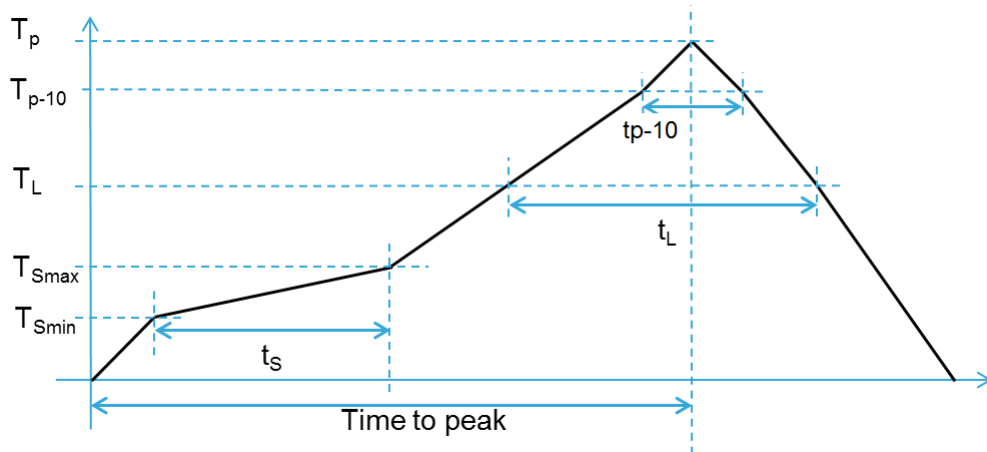

Note: The component should be limited to a maximum of three passes through this solder profile.

Note: As the VL53L4CD package is not sealed, only a dry reflow process should be used (such as convection reflow). Vapor phase reflow is not suitable for this type of optical component.

Note: The VL53L4CD is an optical component and as such, it should be treated carefully. This would typically include using a ‘no wash’ assembly process.

9.6 Handling and storage precautions

9.6.1 Shock precaution

Sensor modules house numerous internal components that are susceptible to shock damage. If a unit is subject to excessive shock, is dropped on the floor, or a tray/reel of units is dropped on the floor, it must be rejected, even if no apparent damage is visible.

9.6.2 Part handling

Handling must be done with non-marring ESD safe carbon, plastic, or teflon tweezers. Ranging modules are susceptible to damage or contamination. The customer is advised to use a clean assembly process after removing the tape from the parts, and until a protective cover glass is mounted.

9.6.3 Compression force

A maximum compressive load of 25 N should be applied on the module.

9.6.4 Moisture sensitivity level

Moisture sensitivity is level 3 (MSL) as described in IPC/JEDEC JSTD-020-C.

9.7 Storage temperature conditions

Table 18. Recommended storage conditions

Parameter	Min.	Typ.	Max.	Unit
Temperature (storage)	-40	23	85	°C

10 Package information

In order to meet environmental requirements, ST offers these devices in different grades of **ECOPACK** packages, depending on their level of environmental compliance. ECOPACK specifications, grade definitions and product status are available at: www.st.com. ECOPACK is an ST trademark.

11 Ordering information

Table 19. Order codes

Order codes	Package	Packing	Minimum order quantity
VL53L4CDV0DH/1	Optical LGA12 with liner	Tape and reel	4500 pcs

Revision history

Table 20. Document revision history

Date	Version	Changes
15-Oct-2021	1	Initial release
29-Oct-2021	2	Correct the Active Ranging values in Section 4.4 Current consumption Update Figure 16. Ranging accuracy vs. distance
03-Jan-2022	3	Modify the FoV range from 1200 mm to 1300 mm in Section Features and Section Description

Contents

1	Product overview	3
1.1	Technical specification	3
1.2	System block diagram	3
1.3	Device pinout	4
1.4	Application schematic	5
2	Functional description	7
2.1	System functional description	7
2.2	State machine description	8
2.3	Customer manufacturing calibration flow	8
2.4	Device programming and control	8
2.5	Digital processing and reading the results	8
2.6	Reading the results	9
2.7	Power sequence	9
2.8	Ranging sequence	10
2.9	Handshake management	10
3	Control interface	11
3.1	I2C interface - timing characteristics	13
3.2	I2C interface - reference registers	15
4	Electrical characteristics	16
4.1	Absolute maximum ratings	16
4.2	Recommended operating conditions	16
4.3	ESD	16
4.4	Current consumption	17
4.5	Digital input and output	17
5	Ranging performances	18
5.1	Measurement conditions	18
5.2	Minimum ranging distance	18
5.3	Maximum ranging distance	18
5.4	Ranging accuracy	19

5.5	Ranging drift with temperature.	20
6	Outline drawings	21
7	Field of view (FoV) and field of illumination (Fol)	25
8	Laser safety considerations.	26
9	Packaging and labeling	27
9.1	Product marking	27
9.2	Inner box labeling	27
9.3	Packing	27
9.4	Tape outline drawing	28
9.5	Pb-free solder reflow process	29
9.6	Handling and storage precautions	30
9.6.1	Shock precaution	30
9.6.2	Part handling	30
9.6.3	Compression force	30
9.6.4	Moisture sensitivity level	30
9.7	Storage temperature conditions	30
10	Package information	31
11	Ordering information	32
	Revision history	33
	Contents	34

IMPORTANT NOTICE – PLEASE READ CAREFULLY

STMicroelectronics NV and its subsidiaries (“ST”) reserve the right to make changes, corrections, enhancements, modifications, and improvements to ST products and/or to this document at any time without notice. Purchasers should obtain the latest relevant information on ST products before placing orders. ST products are sold pursuant to ST’s terms and conditions of sale in place at the time of order acknowledgement.

Purchasers are solely responsible for the choice, selection, and use of ST products and ST assumes no liability for application assistance or the design of Purchasers’ products.

No license, express or implied, to any intellectual property right is granted by ST herein.

Resale of ST products with provisions different from the information set forth herein shall void any warranty granted by ST for such product.

ST and the ST logo are trademarks of ST. For additional information about ST trademarks, please refer to www.st.com/trademarks. All other product or service names are the property of their respective owners.

Information in this document supersedes and replaces information previously supplied in any prior versions of this document.

© 2022 STMicroelectronics – All rights reserved