

MC22005A6W-SPTLY3.3-V2	2 x 20	5mm Character Height	LCD Module
Specification			
Version: 1		Date: 12/03/2021	
Revision			
1	10/03/2021	First Issue	

Display Features			
Character Count		2 x 20	
Appearance		Black on Yellow/Green	
Logic Voltage		3.3V	
Interface		Parallel	
Font Set		English / Japanese	
Display Mode		Transflective	
Character Height		5.55mm	
LC Type		STN	
Module Size		116.00 x 37.00 x 13.50 mm	
Operating Temperature		-20°C ~ +70°C	
Construction	COB	Box Quantity	Weight / Display
LED Backlight	Yellow/Green	---	---



* - For full design functionality, please use this specification in conjunction with the ST7066U + ST7063C specification. (Provided Separately)

Display Accessories	
Part Number	Description
MCCBL1A16SLIP -16DILS-150	16 Way, Single in-line to Dual In-line connector Cable.

Optional Variants		
Fonts	Appearances	Voltage
	Black on White White on Blue	



FEATURES

AVAILABLE OPTIONS	CHARACTERISTICS
DISPLAY FORMAT	20 Characters by 2 Lines
POLARIZER OPTIONS	Positive Transflective
BACKLIGHT TYPE OPTIONS	Edge Type LED Backlight (Long life span version)
BACKLIGHT COLOR OPTIONS	Yellow-Green color
LCD PANEL OPTIONS	Yellow-Green STN
VIEWING ANGLE OPTIONS	6:00 (Bottom)
TEMPERATURE RANGE OPTIONS	-20°C ~ 70°C, Single Supply Voltage
SUGGESTED DRIVING VOLTAGE	V _{lcm} = 3.3V V _{led} = 3.3V
SUGGESTED LED DRIVING MODE	PIN15: LED+, PIN16: LED-
CONTROLLER	ST7066U + ST7063C
FONT MAP CODE	E Version
DRIVING DUTY	1/16
DRIVING BIAS	1/5

MECHANICAL SPECIFICATIONS

OVERALL SIZE	116.0W x 37.0H	mm	THICKNESS	max 13.5	mm
VIEWING AREA	83.0W x 18.6H	mm	HOLE-HOLE	108.0W x 29.0H	mm
CHARACTER SIZE	3.2W x 5.55H	mm	CHARACTER PITCH	0.50W x 0.80H	mm
DOT SIZE	0.60W x 0.65H	mm	DOT PITCH	0.05W x 0.05H	mm

ABSOLUTE MAXIMUM RATINGS

ITEM	SYMBOL	CONDITION	MIN	TYP	MAX	UNIT
POWER SUPPLY (LOGIC)	V _{dd}	25°C	-0.3	—	7.0	V
POWER SUPPLY (LCD)	V ₀	25°C	V _{dd} -13.5	—	V _{dd} +0.3	V
INPUT VOLTAGE	V _{in}	25°C	-0.3	—	V _{dd} +0.3	V
OPERATING TEMPERATURE	V _{opr}	—	-20	—	70	°C
STORAGE TEMPERATURE	V _{stg}	—	-30	—	80	°C

ELECTRONIC CHARACTERISTICS *

	ITEM	SYMBOL	CONDITION	MIN	TYP	MAX	UNIT
	INPUT VOLTAGE	V _{lcm} = V _{dd}	—	—	3.3	—	V
	SUPPLY CURRENT	I _{dd}	V _{dd} =3.3V	—	1.4	—	mA
	DRIVING VOLTAGE FOR LCD PANEL	V _{lcd} = (V _{dd} - V ₀)	-20°C	—	—	—	V
			0°C	—	—	—	
			25°C	—	—	—	
			50°C	—	—	—	
			70°C	—	—	—	

LCD CHARACTERISTICS

FOR STN/FSTN TYPE LCD Panel (TA=25 °C, Vlcd=5.0V ± 0.5V)

	ITEM	SYMBOL	CONDITION	MIN	TYP	MAX	UNIT
	VIEWING ANGLE	$\Phi 2 - \Phi 1$	K=4	40	—	—	deg
		θ		60			
	CONTRAST RATIO	K	—	6	—	—	—
	RESPONSE TIME(RISE)	TR	—	—	150	250	ms
	RESPONSE TIME(FALL)	TF	—	—	150	250	ms

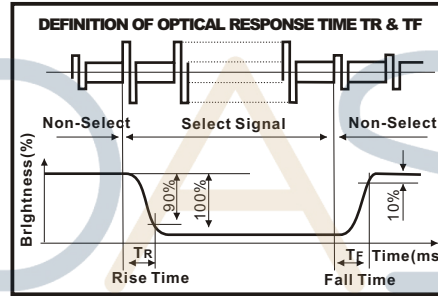
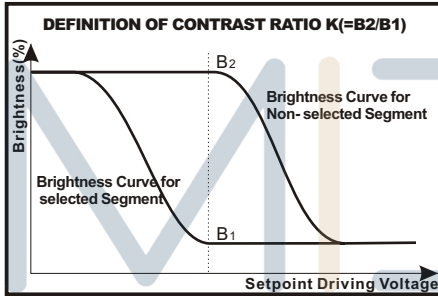
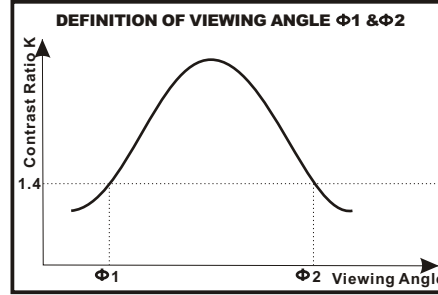
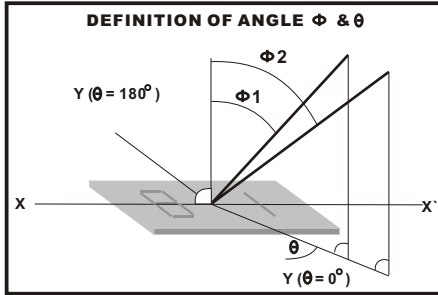

LED CHARACTERISTICS

	ITEM	SYMBOL	CONDITION	MIN	TYP	MAX	UNIT
	LED FORWARD VOLTAGE	Vf	25°C If = 10mA	2.6	—	3.0	V
	LED FORWARD CURRENT	If	25°C	—	10	—	mA
	LED REVERSE CURRENT	Ir	25°C Vr=5.0V	—	—	20	μA
	LED PEAK WAVE LENGTH	λ_p	25°C If = 10mA	569	—	575	nm
	LED BRIGHTNESS (WITHOUT LCD)	Lv	25°C If = 10mA	—	188	—	cd/m ²
	LED BRIGHTNESS UNIFORMITY	Lvmin/Lvmax	25°C If = 10mA	70	—	—	Ratio
	LED LIFE TIME	—	25°C If = 10mA	20K	—	—	Hours



PIN ASSIGNMENT

PIN	SYMBOL	DESCRIPTION	REMARKS
1	Vss	GND	
2	Vdd	Power supply for LCM	3.3V
3	NC	No connection	
4	RS	Register Select Signal	
5	R/W	Data Read / Write	
6	E	Enable Signal	
7	DB0	Data bus line	
8	DB1	Data bus line	
9	DB2	Data bus line	
10	DB3	Data bus line	
11	DB4	Data bus line	
12	DB5	Data bus line	
13	DB6	Data bus line	
14	DB7	Data bus line	
15	LED+	Power supply for BKL	3.3V
16	LED-	Power supply for BKL	

BLOCK DIAGRAM

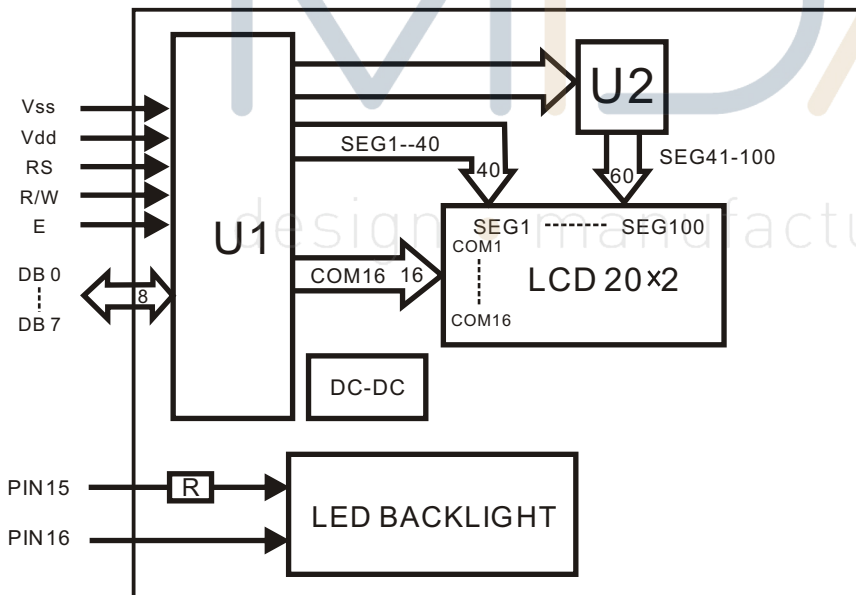

POWER SUPPLY DIAGRAM

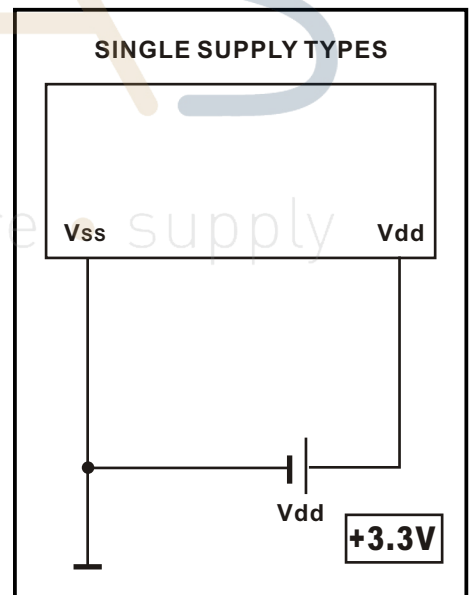

Upper 4bit Lower 4bit	LLLL	LLLH	LLHL	LLHH	LHLL	LHLH	LHHL	LHHH	HLLL	HLLH	HLHL	HLHH	HHLL	HHLH	HHHL	HHHH
LLLL	CG RAM (1)															
LLLH	(2)															
LLHL	(3)															
LLHH	(4)															
LHLL	(5)															
LHLH	(6)															
LHHL	(7)															
LHHH	(8)															
HLLL	(1)															
HLLH	(2)															
HLHL	(3)															
HLHH	(4)															
HHLL	(5)															
HHLH	(6)															
HHHL	(7)															
HHHH	(8)															



