

# SOT-23 Plastic-Encapsulate Transistors

## 2SC2712 TRANSISTOR (NPN)

### FEATURE

- Audio Frequency General Purpose Amplifier Applications
- Low Noise: NF=1 dB (Typ),10dB(MAX)
- Complementary to 2SA1162

### SOT-23

1. BASE
2. EMITTER
3. COLLECTOR

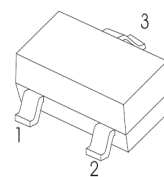

### MAXIMUM RATINGS (T<sub>a</sub>=25°C unless otherwise noted)

| Symbol           | Parameter                     | Value   | Unit |
|------------------|-------------------------------|---------|------|
| V <sub>CB0</sub> | Collector-Base Voltage        | 60      | V    |
| V <sub>CEO</sub> | Collector-Emitter Voltage     | 50      | V    |
| V <sub>EBO</sub> | Emitter-Base Voltage          | 5       | V    |
| I <sub>C</sub>   | Collector Current -Continuous | 150     | mA   |
| P <sub>C</sub>   | Collector Power Dissipation   | 150     | mW   |
| T <sub>J</sub>   | Junction Temperature          | 150     | °C   |
| T <sub>stg</sub> | Storage Temperature           | -55-150 | °C   |

### ELECTRICAL CHARACTERISTICS (T<sub>a</sub>=25°C unless otherwise specified)

| Parameter                            | Symbol               | Test conditions  | Min | Typ | Max  | Unit |
|--------------------------------------|----------------------|--|-----|-----|------|------|
| Collector-base breakdown voltage     | V <sub>(BR)CBO</sub> | I <sub>C</sub> = 100μA, I <sub>E</sub> =0                                | 60  |     |      | V    |
| Collector-emitter breakdown voltage  | V <sub>(BR)CEO</sub> | I <sub>C</sub> =1mA, I <sub>B</sub> =0                                   | 50  |     |      | V    |
| Emitter-base breakdown voltage       | V <sub>(BR)EBO</sub> | I <sub>E</sub> = 100μA, I <sub>C</sub> =0                                | 5   |     |      | V    |
| Collector cut-off current            | I <sub>CBO</sub>     | V <sub>CB</sub> = 60 V, I <sub>E</sub> =0                                |     |     | 0.1  | μA   |
| Emitter cut-off current              | I <sub>EBO</sub>     | V <sub>EB</sub> =5V, I <sub>C</sub> =0                                   |     |     | 0.1  | μA   |
| DC current gain                      | h <sub>FE</sub>      | V <sub>CE</sub> =6V, I <sub>C</sub> =2mA                                 | 70  |     | 700  |      |
| Collector-emitter saturation voltage | V <sub>CE(sat)</sub> | I <sub>C</sub> = 100mA, I <sub>B</sub> =10mA                             |     | 0.1 | 0.25 | V    |
| Transition frequency                 | f <sub>T</sub>       | V <sub>CE</sub> =10V, I <sub>C</sub> = 1mA                               | 80  |     |      | MHz  |
| Output capacitance                   | C <sub>ob</sub>      | V <sub>CB</sub> =10V, I <sub>E</sub> =0, f=1 MHz                         |     | 2.0 | 3.5  | pF   |
| Noise Figure                         | NF                   | V <sub>CE</sub> =6V, I <sub>C</sub> =0.1mA, f=1kHz, R <sub>g</sub> =10kΩ |     | 1.0 | 10   | dB   |

### CLASSIFICATION OF h<sub>FE</sub>

| Rank    | O      | Y       | GR      | BL      |
|---------|--------|---------|---------|---------|
| Range   | 70-140 | 120-240 | 200-400 | 350-700 |
| Marking | LO     | LY      | LG      | LL      |

# Typical Characteristics

Static Characteristic

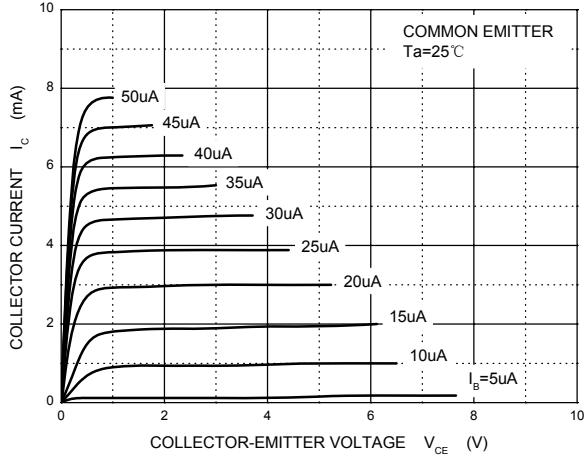

$h_{FE}$  —  $I_c$

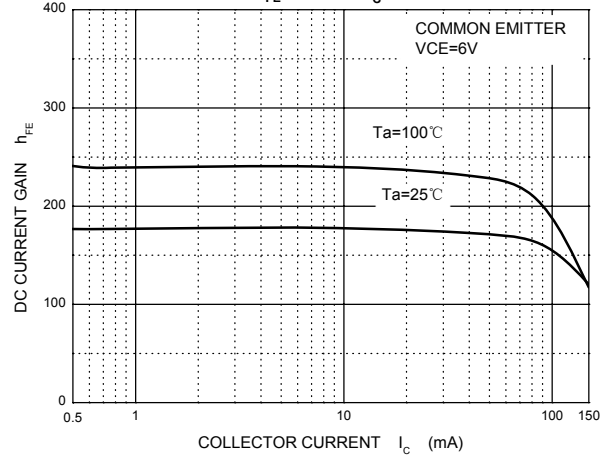

$V_{CEsat}$  —  $I_c$

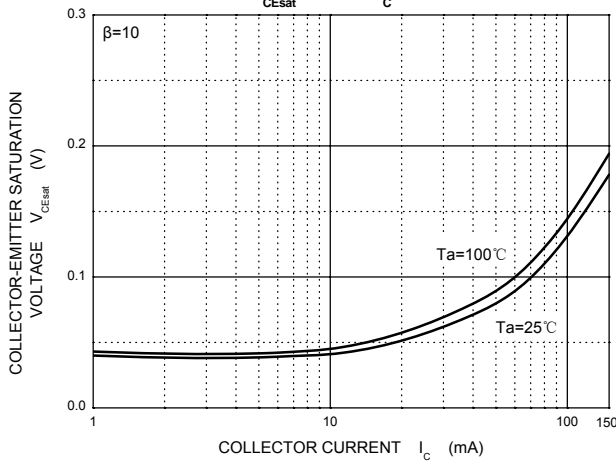

$V_{BEsat}$  —  $I_c$

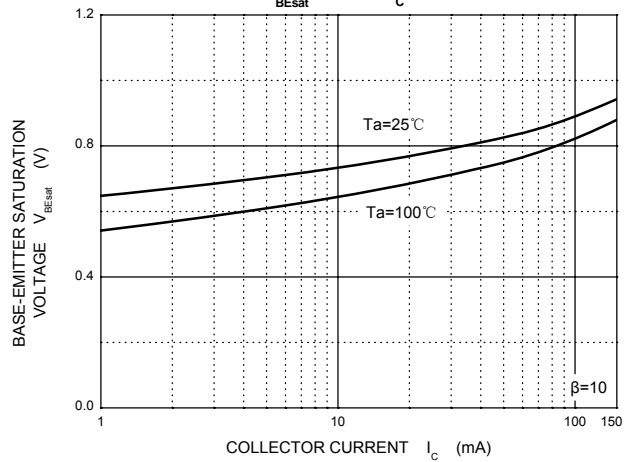

$I_c$  —  $V_{BE}$

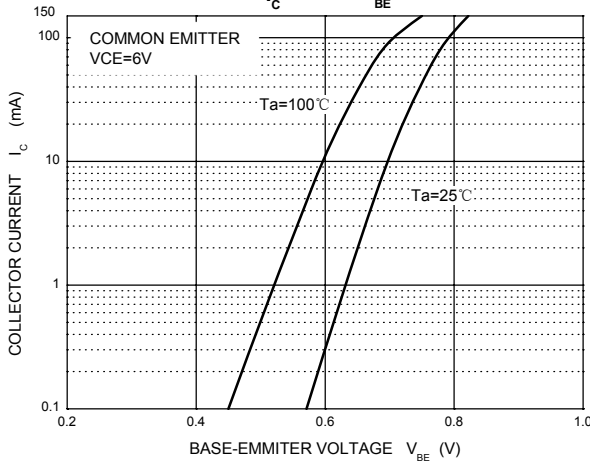

$f_T$  —  $I_c$

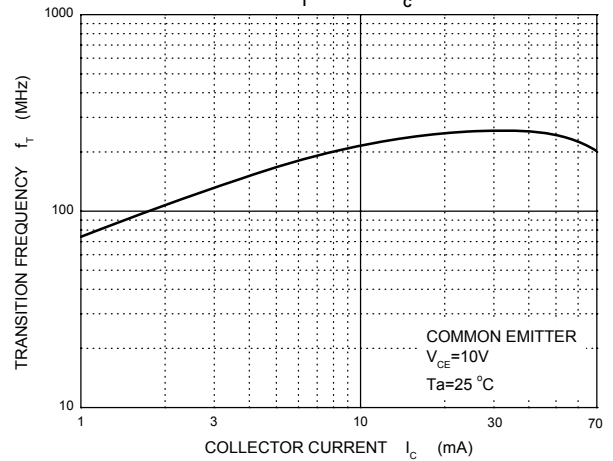

$C_{ob}/C_{ib}$  —  $V_{CB}/V_{EB}$

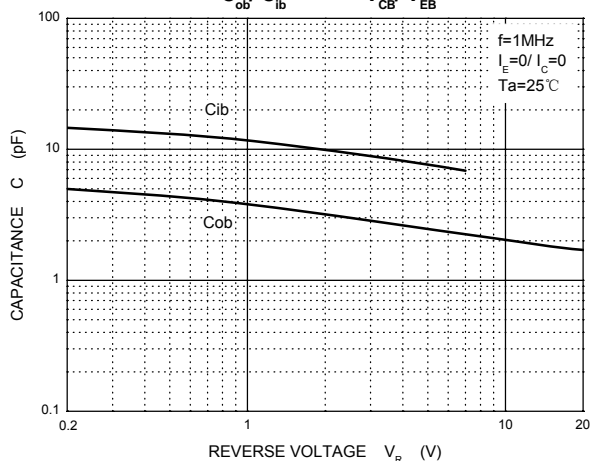

$P_c$  —  $T_a$

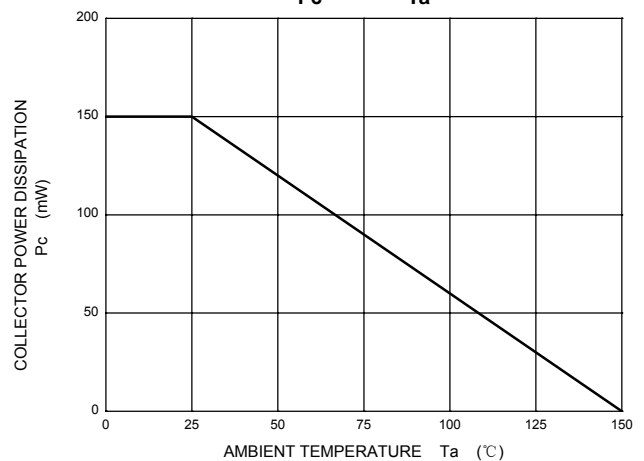

## SOT-23 Package Outline Dimensions

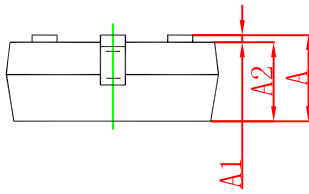

| Symbol | Dimensions In Millimeters |       | Dimensions In Inches |       |
|--------|---------------------------|-------|----------------------|-------|
|        | Min                       | Max   | Min                  | Max   |
| A      | 0.900                     | 1.150 | 0.035                | 0.045 |
| A1     | 0.000                     | 0.100 | 0.000                | 0.004 |
| A2     | 0.900                     | 1.050 | 0.035                | 0.041 |
| b      | 0.300                     | 0.500 | 0.012                | 0.020 |
| c      | 0.080                     | 0.150 | 0.003                | 0.006 |
| D      | 2.800                     | 3.000 | 0.110                | 0.118 |
| E      | 1.200                     | 1.400 | 0.047                | 0.055 |
| E1     | 2.250                     | 2.550 | 0.089                | 0.100 |
| e      | 0.950 TYP                 |       | 0.037 TYP            |       |
| e1     | 1.800                     | 2.000 | 0.071                | 0.079 |
| L      | 0.550 REF                 |       | 0.022 REF            |       |
| L1     | 0.300                     | 0.500 | 0.012                | 0.020 |
| θ      | 0°                        | 8°    | 0°                   | 8°    |

## SOT-23 Suggested Pad Layout



### Note:

1. Controlling dimension: in millimeters.
2. General tolerance:  $\pm 0.05$  mm.
3. The pad layout is for reference purposes only.

# SOT-23 Tape and Reel

## SOT-23 Embossed Carrier Tape



### Packaging Description:

SOT-23 parts are shipped in tape. The carrier tape is made from a dissipative (carbon filled) polycarbonate resin. The cover tape is a multilayer film (Heat Activated Adhesive in nature) primarily composed of polyester film, adhesive layer, sealant, and anti-static sprayed agent. These reeled parts in standard option are shipped with 3,000 units per 7" or 17.8cm diameter reel. The reels are clear in color and is made of polystyrene plastic (anti-static coated).

Dimensions are in millimeter

| Pkg type | A    | B    | C    | d     | E    | F    | P0   | P    | P1   | W    |
|----------|------|------|------|-------|------|------|------|------|------|------|
| SOT-23   | 3.15 | 2.77 | 1.22 | Ø1.50 | 1.75 | 3.50 | 4.00 | 4.00 | 2.00 | 8.00 |

## SOT-23 Tape Leader and Trailer



## SOT-23 Reel

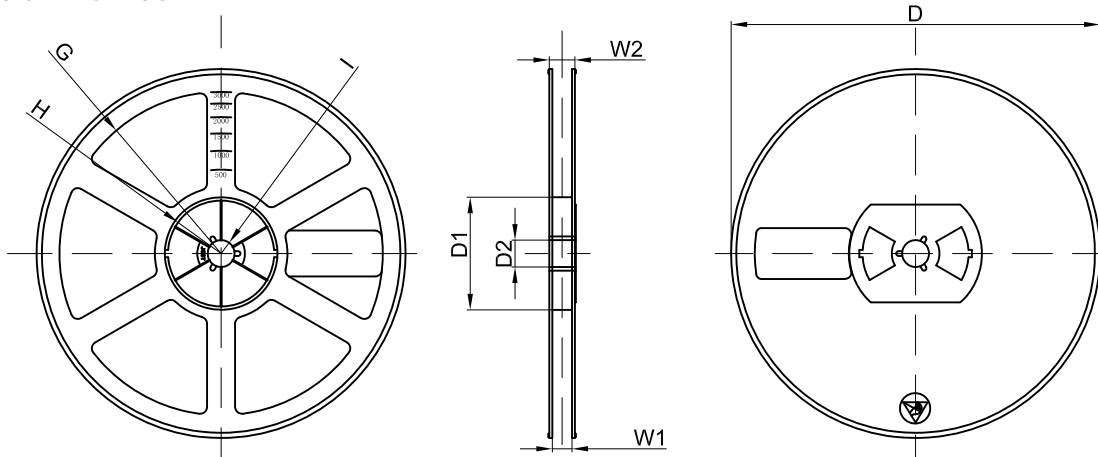

Dimensions are in millimeter

| Reel Option | D       | D1    | D2    | G      | H      | I     | W1   | W2    |
|-------------|---------|-------|-------|--------|--------|-------|------|-------|
| 7"Dia       | Ø178.00 | 54.40 | 13.00 | R78.00 | R25.60 | R6.50 | 9.50 | 12.30 |

| REEL     | Reel Size | Box        | Box Size(mm) | Carton      | Carton Size(mm) | G.W.(kg) |
|----------|-----------|------------|--------------|-------------|-----------------|----------|
| 3000 pcs | 7 inch    | 45,000 pcs | 203×203×195  | 180,000 pcs | 438×438×220     |          |