

GaAs PHEMT MMIC LOW NOISE AMPLIFIER, 700 - 1000 MHz



Typical Applications

The HMC376LP3 / HMC376LP3E is ideal for:

- Cellular/3G Infrastructure
- Base Stations & Repeaters
- CDMA, W-CDMA, & TD-SCDMA
- Private Land Mobile Radio
- GSM/GPRS & EDGE
- UHF Reallocation Applications

Features

- Noise Figure: 0.7 dB
- Output IP3: +36 dBm
- Gain: 15 dB
- Externally Adjustable Supply Current
- Single Positive Supply: +5V
- 50 Ohm Matched Input/Output

Functional Diagram

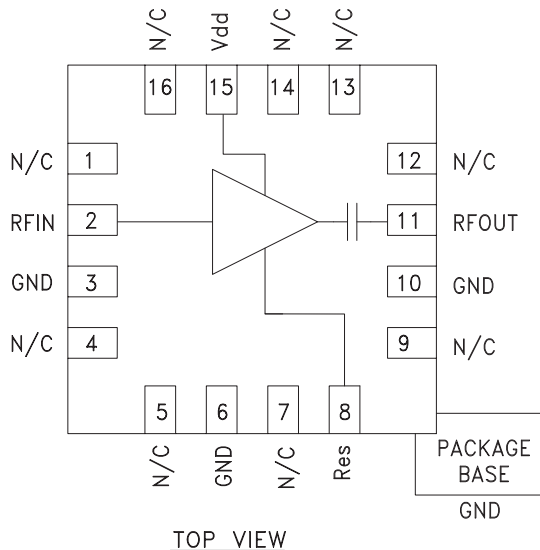

General Description

The HMC376LP3 & HMC376LP3E are GaAs PHEMT MMIC Low Noise Amplifiers that are ideal for GSM & CDMA cellular basestation front-end receivers operating between 700 and 1000 MHz. The amplifier has been optimized to provide 0.7 dB noise figure, 15 dB gain and +36 dBm output IP3 from a single supply of +5V. The HMC376LP3(E) feature an externally adjustable supply current which allows the designer to tailor the linearity performance of the LNA for each application. For applications which require improved noise figure, please see the HMC617LP3(E).

Electrical Specifications, $T_A = +25^\circ C$, $V_{DD} = +5V$, $R_{bias} = 10 Ohms^*$

Parameter	Min.	Typ.	Max.	Min.	Typ.	Max.	Units
Frequency Range	810 - 960			700 - 1000			MHz
Gain	12.5	14.5		11.5	14.5		dB
Gain Variation Over Temperature		0.005	0.01		0.005	0.01	dB / °C
Noise Figure		0.7	1.0		0.7	1.0	dB
Input Return Loss		13			14		dB
Output Return Loss		12			12		dB
Reverse Isolation		20			22		dB
Output Power for 1dB Compression (P1dB)		21.5			21		dBm
Saturated Output Power (Psat)		22			22		dBm
Output Third Order Intercept (IP3) (-20 dBm Input Power per tone, 1 MHz tone spacing)		36			36		dBm
Supply Current (I _{DD})		73			73		mA

*R_{bias} resistor value sets current, see application circuit herein.



GaAs PHEMT MMIC LOW NOISE AMPLIFIER, 700 - 1000 MHz

Broadband Gain & Return Loss

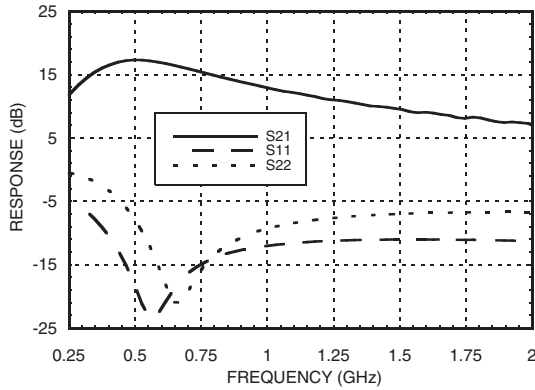

Gain vs. Temperature

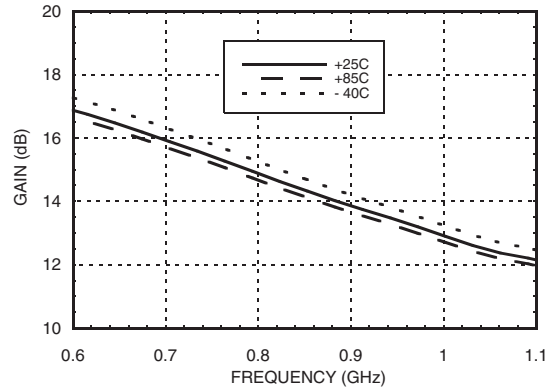

Input Return Loss vs. Temperature

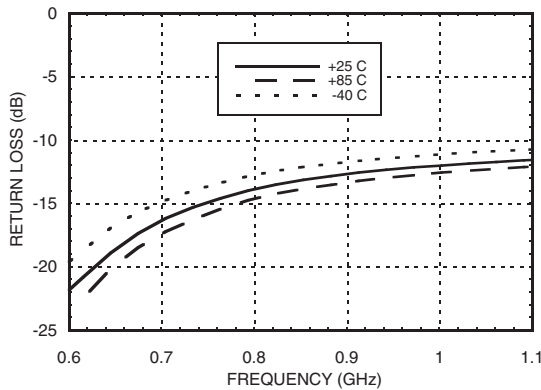

Output Return Loss vs. Temperature

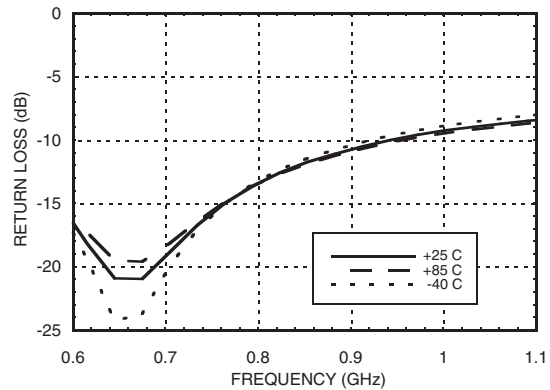

Reverse Isolation vs. Temperature

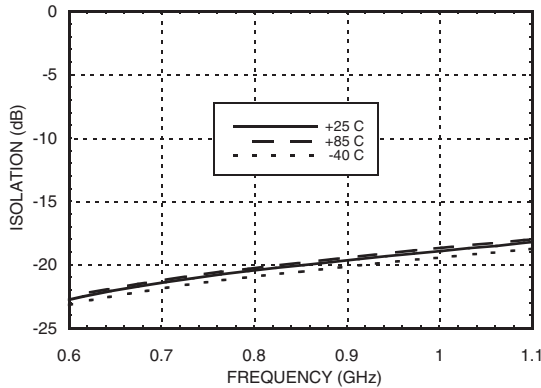

Noise Figure vs. Temperature

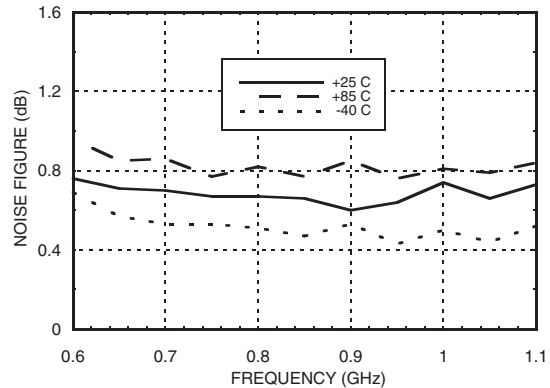

Information furnished by Analog Devices is believed to be accurate and reliable. However, no responsibility is assumed by Analog Devices for its use, nor for any infringements of patents or other rights of third parties that may result from its use. Specifications subject to change without notice. No license is granted by implication or otherwise under any patent or patent rights of Analog Devices. Trademarks and registered trademarks are the property of their respective owners.

For price, delivery, and to place orders: Analog Devices, Inc., One Technology Way, P.O. Box 9106, Norwood, MA 02062-9106 Phone: 781-329-4700 • Order online at www.analog.com Application Support: Phone: 1-800-ANALOG-D



P1dB vs. Temperature @ Idd = 73 mA

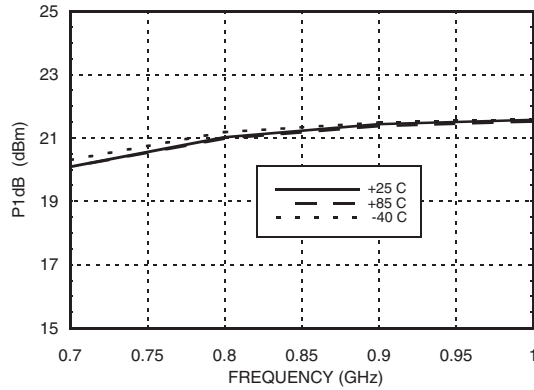

Psat vs. Temperature @ Idd = 73 mA

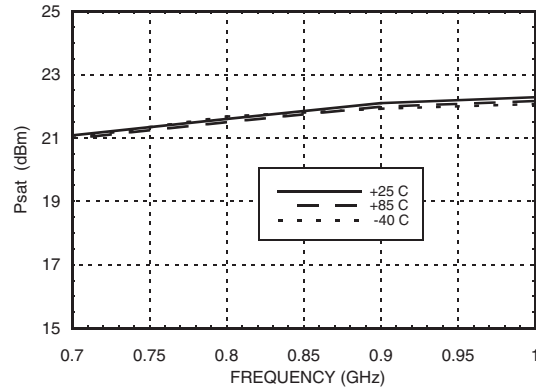

Output IP3 vs. Temperature @ Idd = 73 mA

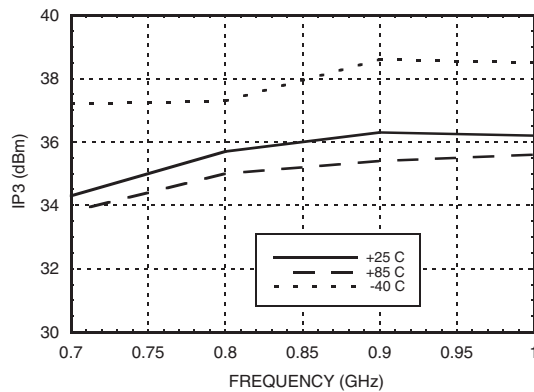

Gain, Noise Figure & Power vs. Supply Current @ 900 MHz

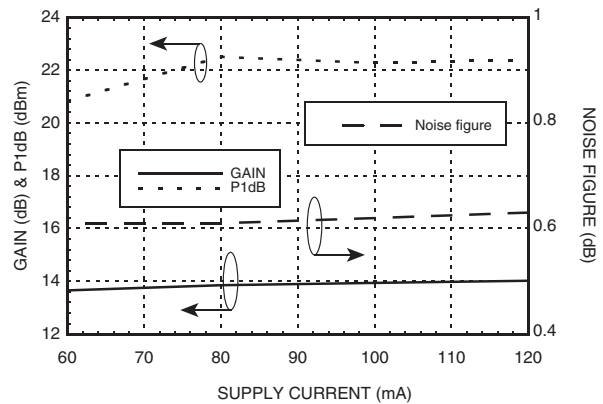

Absolute Maximum Ratings

Drain Bias Voltage (Vdd)	+8.0 Vdc
RF Input Power (RFIN)(Vs = +5.0 Vdc)	+15 dBm
Channel Temperature	150 °C
Continuous P _{diss} (T = 85 °C) (derate 11.83 mW/°C above 85 °C)	0.769 W
Thermal Resistance (channel to ground paddle)	84.5 °C/W
Storage Temperature	-65 to +150 °C
Operating Temperature	-40 to +85 °C

Typical Supply Current vs. Vdd with R_{bias} = 10 Ohms

Vdd (Vdc)	Idd (mA)
+4.5	73.0
+5.0	73.4
+5.5	73.6

Recommended Bias Resistor Values for Various Idd

Idd (mA)	R _{bias} (Ohms)
60	12
70	10
80	9.1
100	6.8
120	5.1



**ELECTROSTATIC SENSITIVE DEVICE
OBSERVE HANDLING PRECAUTIONS**

Information furnished by Analog Devices is believed to be accurate and reliable. However, no responsibility is assumed by Analog Devices for its use, nor for any infringements of patents or other rights of third parties that may result from its use. Specifications subject to change without notice. No license is granted by implication or otherwise under any patent or patent rights of Analog Devices. Trademarks and registered trademarks are the property of their respective owners.

For price, delivery, and to place orders: Analog Devices, Inc., One Technology Way, P.O. Box 9106, Norwood, MA 02062-9106 Phone: 781-329-4700 • Order online at www.analog.com Application Support: Phone: 1-800-ANALOG-D



Outline Drawing

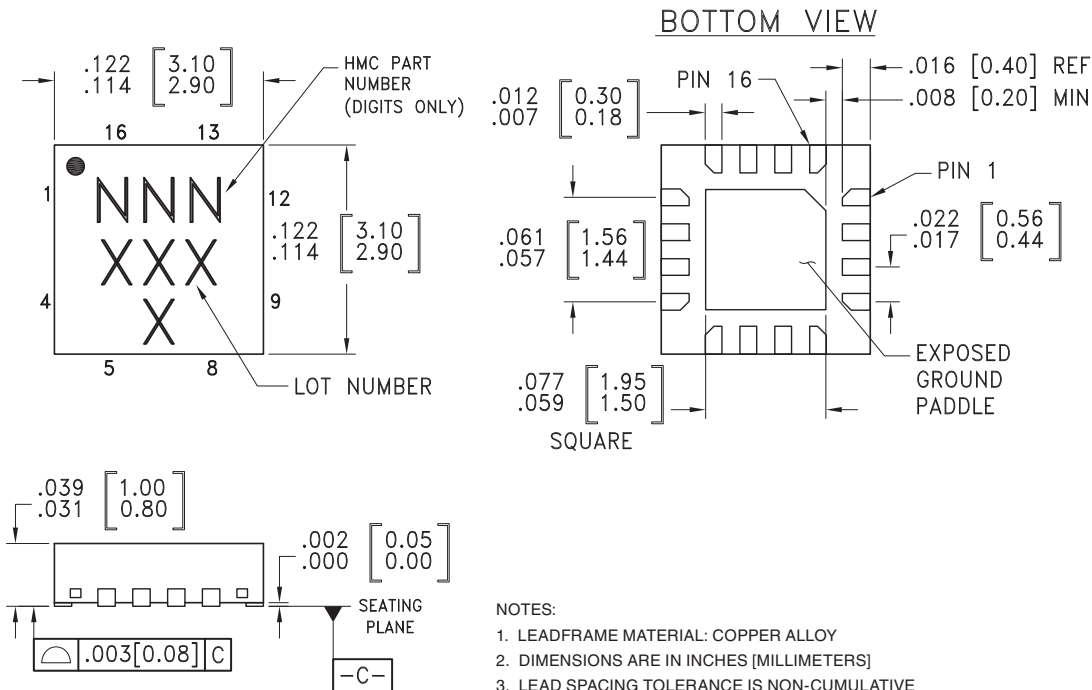

- NOTES:
1. LEADFRAME MATERIAL: COPPER ALLOY
 2. DIMENSIONS ARE IN INCHES [MILLIMETERS]
 3. LEAD SPACING TOLERANCE IS NON-CUMULATIVE
 4. PAD BURR LENGTH SHALL BE 0.15mm MAXIMUM.
PAD BURR HEIGHT SHALL BE 0.05mm MAXIMUM.
 5. PACKAGE WARP SHALL NOT EXCEED 0.05mm.
 6. ALL GROUND LEADS AND GROUND PADDLE MUST BE SOLDERED TO PCB RF GROUND.
 7. REFER TO HITTITE APPLICATION NOTE FOR SUGGESTED LAND PATTERN.

Package Information

Part Number	Package Body Material	Lead Finish	MSL Rating	Package Marking ^[3]
HMC376LP3	Low Stress Injection Molded Plastic	Sn/Pb Solder	MSL1 ^[1]	H376 XXXX
HMC376LP3E	RoHS-compliant Low Stress Injection Molded Plastic	100% matte Sn	MSL1 ^[2]	H376 XXXX

[1] Max peak reflow temperature of 235 °C

[2] Max peak reflow temperature of 260 °C

[3] 4-Digit lot number XXXX



Pin Descriptions

Pin Number	Function	Description	Interface Schematic
1, 4, 5, 7, 9, 12 - 14, 16	N/C	No connection necessary. These pins may be connected to RF/DC ground. Performance will not be affected.	
2	RFIN	This pin is matched to 50 Ohms with a 47 nH inductor to ground. See application circuit.	
3, 6, 10	GND	These pins and package bottom must be connected to RF/DC ground.	
8	Res	This pin is used to set the DC current of the amplifier by selection of external bias resistor. See application circuit.	
11	RFOUT	This pin is AC coupled and matched to 50 Ohms from 0.7 - 1.0 GHz.	
15	Vdd	Power supply voltage. Choke inductor and bypass capacitors are required. See application circuit.	

Application Circuit

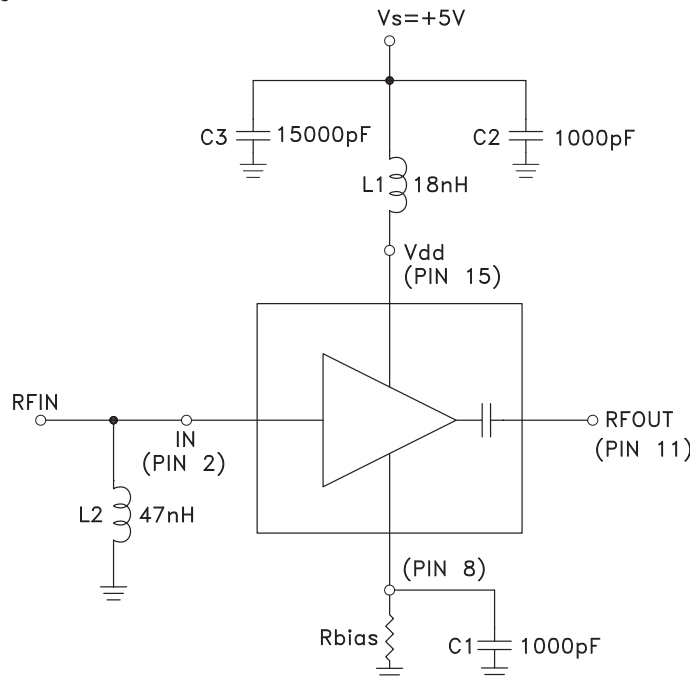

Note 1: L1, L2 and C1 should be located as close to the pins as possible.

Information furnished by Analog Devices is believed to be accurate and reliable. However, no responsibility is assumed by Analog Devices for its use, nor for any infringements of patents or other rights of third parties that may result from its use. Specifications subject to change without notice. No license is granted by implication or otherwise under any patent or patent rights of Analog Devices. Trademarks and registered trademarks are the property of their respective owners.

For price, delivery, and to place orders: Analog Devices, Inc., One Technology Way, P.O. Box 9106, Norwood, MA 02062-9106 Phone: 781-329-4700 • Order online at www.analog.com Application Support: Phone: 1-800-ANALOG-D



Evaluation PCB

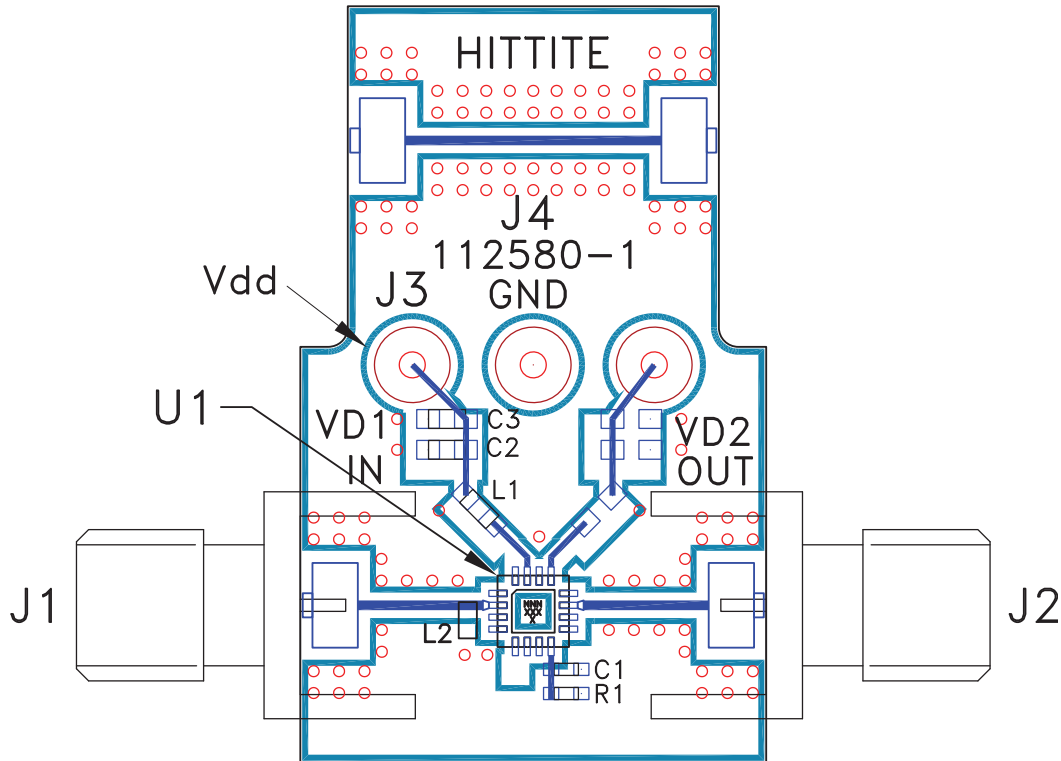

List of Materials for Evaluation PCB 112585 [1]

Item	Description
J1 - J2	PCB Mount SMA RF Connector
J3 - J4	DC Pin
C1	1000 pF Capacitor, 0402 Pkg.
C2	1000 pF Capacitor, 0603 Pkg.
C3	15000 pF Capacitor, 0603 Pkg.
L1	18 nH Inductor, 0603 Pkg.
L2	47 nH Inductor, 0603 Pkg.
R1	Resistor, 0402 Pkg.
U1	HMC376LP3 / HMC376LP3E Amplifier
PCB [2]	112580 Evaluation PCB

[1] Reference this number when ordering complete evaluation PCB

[2] Circuit Board Material: Rogers 4350

The circuit board used in the application should use RF circuit design techniques. Signal lines should have 50 Ohm impedance while the package ground leads and exposed paddle should be connected directly to the ground plane similar to that shown. A sufficient number of via holes should be used to connect the top and bottom ground planes. The evaluation circuit board shown is available from Hittite upon request.

Mouser Electronics

Authorized Distributor

Click to View Pricing, Inventory, Delivery & Lifecycle Information:

[Analog Devices Inc.:](#)

[HMC376LP3E](#) [HMC376LP3ETR](#) [112585-HMC376LP3](#)