

Datasheet

SaBLE-x-R2[™] Bluetooth[®] Smart (BLE) Module

Version 1.6

REVISION HISTORY

Version	Date	Notes	Contributors	Approver
1.0	20 June 2017	Initial Release		Josh Bablitch
1.1	22 June 2017	Updated Device Markings Section		Josh Bablitch
1.2	6 July 2017	Added Industry Canada Statement		Josh Bablitch
1.3	21 Aug 2017	Added mFlexPIFA antenna information		Bill Steinike
1.4	9 Nov 2017	Updated Certification Section		Robert Gosewehr
1.5	22 Oct 2018	Updated legal statement, label info, & added new part numbers		Robert Gosewehr
1.6	13 Nov 2019	Fixed antenna type error in Ordering Information table (450-0185)	Derek Wong	Jonathan Kaye

CONTENTS

1	Description.....	4
2	Features	4
3	Applications	4
4	Ordering Information.....	5
5	Module Accessories	6
6	Pin Descriptions.....	8
1	Electrical Specifications.....	9
1.1	Absolute Maximum Ratings.....	9
1.2	Recommended Operating Conditions	9
1.3	General Characteristics.....	9
1.4	DC Characteristics	10
1.5	General Power Consumption	11
1.6	RF Characteristics - TX.....	11
1.7	RF Characteristics – RX 1 Mbps (BLE).....	12
1.8	RF Characteristics – RX 2 Mbps (BLE5).....	12
1.9	RF Characteristics – RX 125-kbps Coded (BLE5)	13
1.10	RF Characteristics – RX 500-kbps Coded (BLE5)	13
1.11	Wakeup Timing	14
2	Soldering Recommendations.....	16
3	Cleaning	16
4	Optical Inspection.....	16
5	Rework	17
6	Shipping, Handling, and Storage.....	17
7	Agency Certifications.....	17
8	Agency Statements	18
9	Europe.....	20
10	Australia	21
11	Bluetooth SIG Qualification	22
12	Antenna Information	24
13	Mechanical Data.....	31
14	PCB Footprint.....	32
14.1	Tape and Reel Dimensions	33
15	Device Markings	34
15.1	450-0177 and 450-0178.....	34
15.2	450-0194 and 450-0195.....	35
16	Contacting Laird	36

1 DESCRIPTION

Laird is announcing a low-cost and low-power consumption module with all Bluetooth 5 Low Energy functionalities.

The SaBLE-x-R2 module fully supports the single mode Bluetooth Low Energy operation and the output power can support class 2. The module provides the ability to either put your entire application into the integrated ARM Cortex M3 microcontroller.

Need to get to market quickly? Not an expert in Bluetooth Low Energy? Need a custom antenna? Do you need help with your host board? Laird Connectivity Design Services will be happy to develop custom hardware or software or help integrate the design. Contact us at sales@lairdconnect.com or call us at 262-375-4400.



2 FEATURES

- Built-in CC2640R2F Bluetooth 5 Low Energy System-On-Chip (SOC) 5x5 mm RHB package with 15 GPIOs
- 128 kB Flash/20 kB SRAM
- RF Output Power: +5 dBm
- RF Receive Sensitivity: -96 dBm
- Size: 11.6 mm x 17.9 mm x 2.4 mm
- Operating Voltage: 1.8V to 3.8V
- Operating Temperature: -40 to +85C
- 8.4 mA Transmit Mode (+5 dBm)
- 7.4 mA Receive Mode
- 1µA Standby (SRAM/CPU retention and RTC running) with quick 100 µs start up
- 200 nA Shutdown
- 61µA/MHz Active CPU Current
- Drivers, Bluetooth Low Energy Controller, and bootloader in ROM
- Flexible peripheral set
- On board 32 KHz and 24 MHz Crystals
- Worldwide Acceptance:
 - FCC (USA)
 - IC (Canada)
 - ETSI (Europe)
 - Giteki (Japan)
 - RCM (AU/NZ)
- BT SIG QD ID: 96853
- REACH and RoHS-compliant

3 APPLICATIONS

- Consumer electronics
- Mobile phone accessories
- Sports and fitness equipment
- HID applications
- Home and building automation, lighting control, alarm and security
- Electronic shelf labeling and proximity tags





4 ORDERING INFORMATION

Table 1: Orderable model numbers

Order Number	Description
450-0177C	SaBLE-x-R2 Module, PCB Trace Antenna (Cut Tape)
450-0177R	SaBLE-x-R2 Module, PCB Trace Antenna (Tape & Reel)
450-0178C	SaBLE-x-R2 Module, External Antenna Port (Cut Tape)
450-0178R	SaBLE-x-R2 Module, External Antenna Port (Tape & Reel)
450-0184	SaBLE-x-R2 Evaluation Kit, PCB Trace Antenna
450-0185	SaBLE-x-R2 Development Kit, External Antenna Port
450-0194C	SaBLE-x-R2 Module, Non-Ferrous Shield, PCB Trace Antenna (Cut Tape)
450-0194R	SaBLE-x-R2 Module, Non-Ferrous Shield, PCB Trace Antenna (Tape & Reel)
450-0195C	SaBLE-x-R2 Module, Non-Ferrous Shield, External Antenna Port (Cut Tape)
450-0195R	SaBLE-x-R2 Module, Non-Ferrous Shield, External Antenna Port (Tape & Reel)

5 MODULE ACCESSORIES

Table 2: Module accessories

	Order Number	Description
	001-0001	2.4 GHz Dipole Antenna with Reverse Polarity SMA Connector
	080-0001	U.FL to Reverse Polarity SMA Bulkhead Cable 105 mm
	001-0014	2.4 GHz FlexPIFA antenna
	001-0015	2.4 GHz FlexNotch Antenna
	001-0030	2.4 GHz Metal FlexPIFA Antenna w/U.FL Cable, 100mm

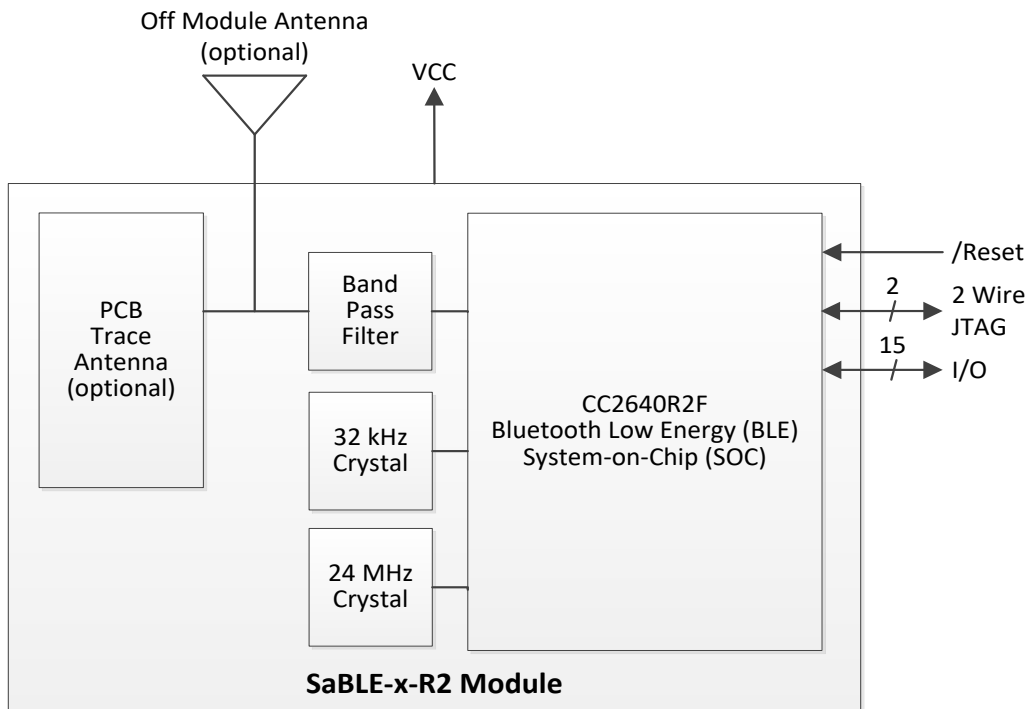

Figure 1: SaBLE-x-R2 module block diagram

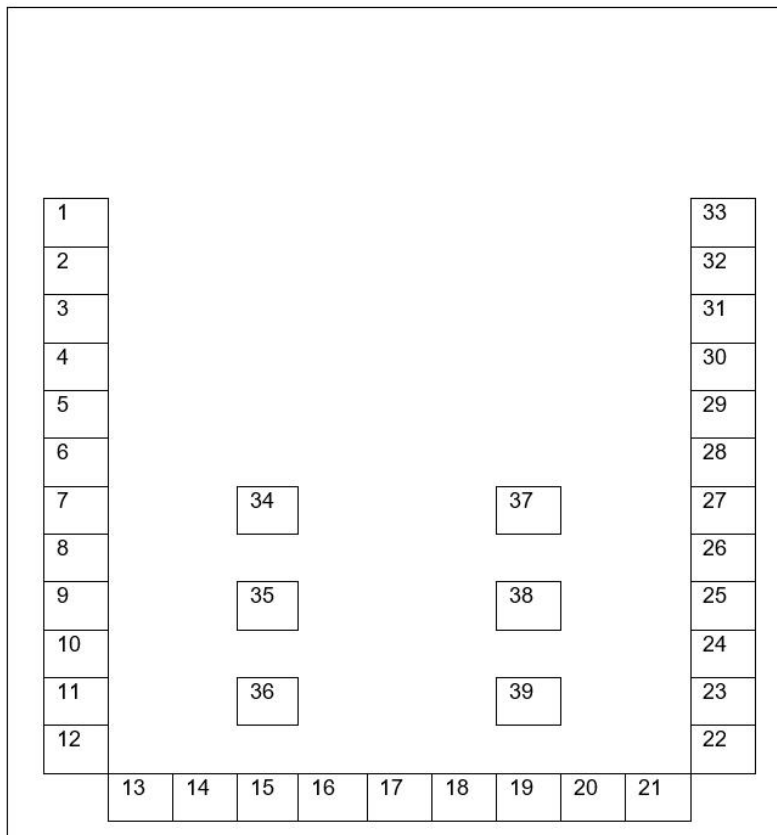

Figure 2: SaBLE-x-R2 module footprint (viewed from top)

6 PIN DESCRIPTIONS

Table 3: SaBLE-x-R2 Pin Descriptions

Module Pin	Name	I/O Type	Description
1	RF OUT	RF	Antenna, 50 OHMS
2	GND	GND	Ground
3	GND	GND	Ground
4	NC	-	No Connect (Do Not Connect)
5	NC	-	No Connect (Do Not Connect)
6	/RESET	DI	Active Low Reset. 100 kΩ Pull-up
7	JTAG_TCKC	DI/DIO	JTAG TCKC
8	JTAG_TMSC	DIO	JTAG TMS
9	NC	-	No Connect (Do Not Connect)
10	NC	-	No Connect (Do Not Connect)
11	VCC	PI	Power Supply to Module
12	VCC	PI	Power Supply to Module
13	DIO_5/JTAG_TDO	DIO	GPIO, JTAG_TDO, LED Driving Capability
14	DIO_6/JTAG_TDI	DIO	GPIO, JTAG_TDI, LED Driving Capability
15	DIO_4	DIO	GPIO, ULP Sensor Interface, LED Driving Capability
16	DIO_3	DIO	GPIO, ULP Sensor Interface, LED Driving Capability
17	DIO_2	DIO	GPIO, ULP Sensor Interface, LED Driving Capability
18	DIO_1/BOOT_RX	DIO	GPIO, ULP Sensor Interface, Bootloader RX (UART0)
19	DIO_0/BOOT_TX	DIO	GPIO, ULP Sensor Interface, Bootloader TX (UART0)
20	DIO_7	DIO	GPIO, Analog Input, ULP Sensor Interface
21	DIO_8	DIO	GPIO, Analog Input, ULP Sensor Interface
22	GND	GND	Ground
23	DIO_10	DIO	GPIO, Analog Input, ULP Sensor Interface
24	DIO_9	DIO	GPIO, Analog Input, ULP Sensor Interface
25	NC	-	No Connect (Do Not Connect)
26	NC	-	No Connect (Do Not Connect)
27	NC	-	No Connect (Do Not Connect)
28	NC	-	No Connect (Do Not Connect)
29	DIO_11	DIO	GPIO, Analog Input, ULP Sensor Interface
30	DIO_12	DIO	GPIO, Analog Input, ULP Sensor Interface
31	DIO_13	DIO	GPIO, Analog Input, ULP Sensor Interface
32	DIO_14	DIO	GPIO, Analog Input, ULP Sensor Interface
33	GND	GND	Ground
34-39	GND	GND	Ground and Thermal Relief Pads

PI = Power Input
GND = Ground
DI = Digital Input

DO = Digital Output
DIO = Digital Input/Output

AI = Analog Input
RF = Bi-directional RF Port

Note: See the Texas Instruments CC2640 datasheet and user guide for further details on the I/O.

1 ELECTRICAL SPECIFICATIONS

1.1 Absolute Maximum Ratings

Table 4: Absolute maximum ratings

Symbol	Description	Min	Max	Unit
VCC	Digital Input Supply Voltage	-0.3	4.1	V
Voltage on any digital pin		-0.3	VCC+0.3, max 4.1	V
Input RF level			+5	dBm

IMPORTANT!

Do not exceed the absolute maximum ratings specified in Table 4 under any circumstances. Stressing the module beyond these limits may result in permanent damage to the module; this damage is not covered by the warranty.

1.2 Recommended Operating Conditions

Test Conditions: Ambient Temp = 25°C

Table 5: Recommended operating conditions

Symbol	Min	Typ	Max	Unit
VCC	1.8	3.3	3.8	V

1.3 General Characteristics

Table 6: General Characteristics

Characteristic	Description
Model Name	SaBLE-x-R2
Product Description	Bluetooth Low Energy Wireless Module
Dimension	11.63 mm x 17.86 mm x 2.4 mm (W*L*T)
Operating temperature	-40°C to 85°C
Storage temperature	-40°C to 85°C
Humidity	Operating Humidity: 10% to 95% Non-Condensing Storage Humidity: 5% to 95% Non-Condensing
Weight	0.75 g ± 0.05 g

1.4 DC Characteristics

Table 7: SaBLE-x-R2 module Bluetooth general DC characteristics

Parameter	Test Conditions	Min	Typ	Max	Unit
Input low-to-high transition with hysteresis	Transition from 0 to 1, T _A = 25°C, VCC=1.8V		1.07		V
Input high-to-low transition with hysteresis	Transition from 1 to 0, T _A = 25°C, VCC=1.8V		0.74		V
Input hysteresis	Difference between 0 to 1 and 1 to 0.		0.33		V
Input low-to-high transition with hysteresis	Transition from 0 to 1, T _A = 25°C, VCC=3.8V		1.94		V
Input high-to-low transition with hysteresis	Transition from 1 to 0, T _A = 25°C, VCC=3.8V		1.54		V
Input hysteresis	Difference between 0 to 1 and 1 to 0.		0.40		V
Logic-0 output voltage, 4 mA pins	Output load 4 mA, T _A = 25°C, VCC=1.8V		0.26		V
Logic-1 output voltage, 4 mA pins	Output load 4 mA, T _A = 25°C, VCC=1.8V		1.54		V
Logic-0 output voltage, 8 mA pins	Output load 8 mA, T _A = 25°C, VCC=1.8V		0.21		V
Logic-1 output voltage, 8 mA pins	Output load 8 mA, T _A = 25°C, VCC=1.8V		1.58		V
Logic-0 output voltage, 4 mA pins	Output load 4 mA, T _A = 25°C, VCC=3.0V		0.33		V
Logic-1 output voltage, 4 mA pins	Output load 4 mA, T _A = 25°C, VCC=3.0V		2.72		V
Logic-0 output voltage, 8 mA pins	Output load 8 mA, T _A = 25°C, VCC=3.0V		0.28		V
Logic-1 output voltage, 8 mA pins	Output load 8 mA, T _A = 25°C, VCC=3.0V		2.68		V
Input pullup current	Vpad=0V, T _A = 25°C, VCC=1.8V		72		uA
Input pulldown current	Vpad=1.8V, T _A = 25°C, VCC=1.8V		22		uA
Input pullup current	Vpad=0V, T _A = 25°C, VCC=3.8V		277		uA
Input pulldown current	Vpad=3.8V, T _A = 25°C, VCC=3.8V		113		uA

1.5 General Power Consumption

$T_A = 25^\circ\text{C}$

Table 8: SaBLE-x-R2 module Bluetooth TX and RX current consumption specifications

Parameter	Test Conditions	Min	Typical Average Current				Max	Unit
			1.8V	3.0V	3.3V	3.8V		
Shutdown	No clocks running, no data retention				200			nA
Standby 1	With RTC, CPU, RAM, and partial register retention. XOSC_LF				1.2			uA
Standby 2	With Cache, RTC, CPU, RAM, and partial register retention. XOSC_LF				2.7			uA
Idle	Supply Systems and RAM powered.				550			uA
Active	Core running CoreMark				1.45 mA + 31 uA/MHz			
Radio RX	DC-DC Turned OFF		12.7	12.8	12.9	13.0		mA
Radio TX	+5 dBm output power		13.6	9.0	8.4	7.9		

1.6 RF Characteristics - TX

The following results are typical performance for the following data rates:

1 Mbps (BLE), 2 Mbps (BLE5), 125 kbps, and 500 kbps Coded (BLE5)

Results measured on Laird Connectivity SaBLE-x-R2 external antenna development board reference design with $T_A = 25^\circ\text{C}$, LEDs disabled, DC-to-DC converter enabled, and measured at RF connector.

Table 9: BLE TX RF characteristics

Parameter	Test Conditions	Min	Typical				Max	Unit
			1.8V	3.0V	3.3V	3.8V		
Output Power	CH 0 (2402 MHz)		4.8	4.8	4.8	4.8		dBm
	CH 19 (2440 MHz)		4.6	4.7	4.7	4.7		
	CH 39 (2480 MHz)		4.3	4.3	4.3	4.4		
Spurious Emission Conducted Measurement	$f < 1\text{ GHz}$				-43			dBm
	$f > 1\text{ GHz}$				-46			dBm
RF Frequency Range	Programmable in one-MHz steps	2402					2480	MHz

1.7 RF Characteristics – RX 1 Mbps (BLE)

Table 10: BLE TX RF characteristics

Parameter	Test Conditions	Min	Typical				Max	Unit
			1.8V	3.0V	3.3V	3.8V		
Receiver Sensitivity DC to DC Disabled	CH 0 (2402 MHz)		-95	-95	-95	-95	dBm	
	CH 19 (2440 MHz)		-95	-95	-95	-95		
	CH 39 (2480 MHz)		-95	-95	-95	-95		
Receiver Sensitivity DC to DC Enabled	CH 0 (2402 MHz)		-95	-94	-93	-92	dBm	
	CH 19 (2440 MHz)		-95	-94	-93	-92		
	CH 39 (2480 MHz)		-95	-94	-93	-92		
Saturation	BER < 0.1%			4			dBm	
Co-channel Rejection	Wanted signal –67 dBm				-6		dB	
Frequency Error Tolerance	Difference between the incoming carrier frequency and the internally-generated carrier frequency	-350				350	kHz	
Intermodulation	Minimum interferer level				-34		dBm	

1.8 RF Characteristics – RX 2 Mbps (BLE5)

Table 11: BLE TX RF characteristics

Parameter	Test Conditions	Min	Typical				Max	Unit
			1.8V	3.0V	3.3V	3.8V		
Receiver Sensitivity DC to DC Disabled	CH 0 (2402 MHz)		-91.5	-91.5	-91.5	-91.5	dBm	
	CH 19 (2440 MHz)		-91.5	-91.5	-91.5	-91.5		
	CH 39 (2480 MHz)		-91.5	-91.5	-91.5	-91.5		
Receiver Sensitivity DC to DC Enabled	CH 0 (2402 MHz)		-91.5	-90	-89.5	-89	dBm	
	CH 19 (2440 MHz)		-91.5	-90	-89.5	-89		
	CH 39 (2480 MHz)		-91.5	-90	-89.5	-89		
Saturation	BER < 0.1%			4			dBm	
Co-channel Rejection	Wanted signal –67 dBm				-7		dB	
Frequency Error Tolerance	Difference between the incoming carrier frequency and the internally-generated carrier frequency	-300				500	kHz	
Intermodulation	Minimum interferer level				-45		dBm	

1.9 RF Characteristics – RX 125-kbps Coded (BLE5)

Table 12: BLE TX RF characteristics

Parameter	Test Conditions	Min	Typical				Max	Unit
			1.8V	3.0V	3.3V	3.8V		
Receiver Sensitivity DC to DC Disabled	CH 0 (2402 MHz)		-102	-102	-102	-102		dBm
	CH 19 (2440 MHz)		-102	-102	-102	-102		
	CH 39 (2480 MHz)		-102	-102	-102	-102		
Receiver Sensitivity DC to DC Enabled	CH 0 (2402 MHz)		-102	-100	-98	-97		dBm
	CH 19 (2440 MHz)		-102	-100	-98	-97		
	CH 39 (2480 MHz)		-102	-100	-98	-97		
Saturation	BER < 0.1%				5			dBm
Co-channel Rejection	Wanted signal –79 dBm				-3			dB
Frequency Error Tolerance	Difference between the incoming carrier frequency and the internally generated carrier frequency	-260					310	kHz
Intermodulation	Minimum interferer level				-42			dBm

1.10 RF Characteristics – RX 500-kbps Coded (BLE5)

Table 13: BLE TX RF characteristics

Parameter	Test Conditions	Min	Typical				Max	Unit
			1.8V	3.0V	3.3V	3.8V		
Receiver Sensitivity DC to DC Disabled	CH 0 (2402 MHz)		-99.5	-99.5	-99.5	-99.5		dBm
	CH 19 (2440 MHz)		-99.5	-99.5	-99.5	-99.5		
	CH 39 (2480 MHz)		-99.5	-99.5	-99.5	-99.5		
Receiver Sensitivity DC to DC Enabled	CH 0 (2402 MHz)		-99.5	-98	-96	-95		dBm
	CH 19 (2440 MHz)		-99.5	-98	-96	-95		
	CH 39 (2480 MHz)		-99.5	-98	-96	-95		
Saturation	BER < 0.1%				5			dBm
Co-channel Rejection	Wanted signal –79 dBm				-5			dB
Frequency Error Tolerance	Difference between the incoming carrier frequency and the internally generated carrier frequency	-240					240	kHz
Intermodulation	Minimum interferer level				-37			dBm

1.11 Wakeup Timing

1.11.1 Shutdown

Shutdown is similar to holding the device in reset with two exceptions:

- It latches the state of IO prior to shutting down.
- It consumes 0.1 uA, versus approximately 37 uA.

Figure 3 shows the response time to wake up from shutdown by using a wake-up pin. The pin is configured to wake the device up on a negative edge. Once the device wakes, it drives an awake pin low:

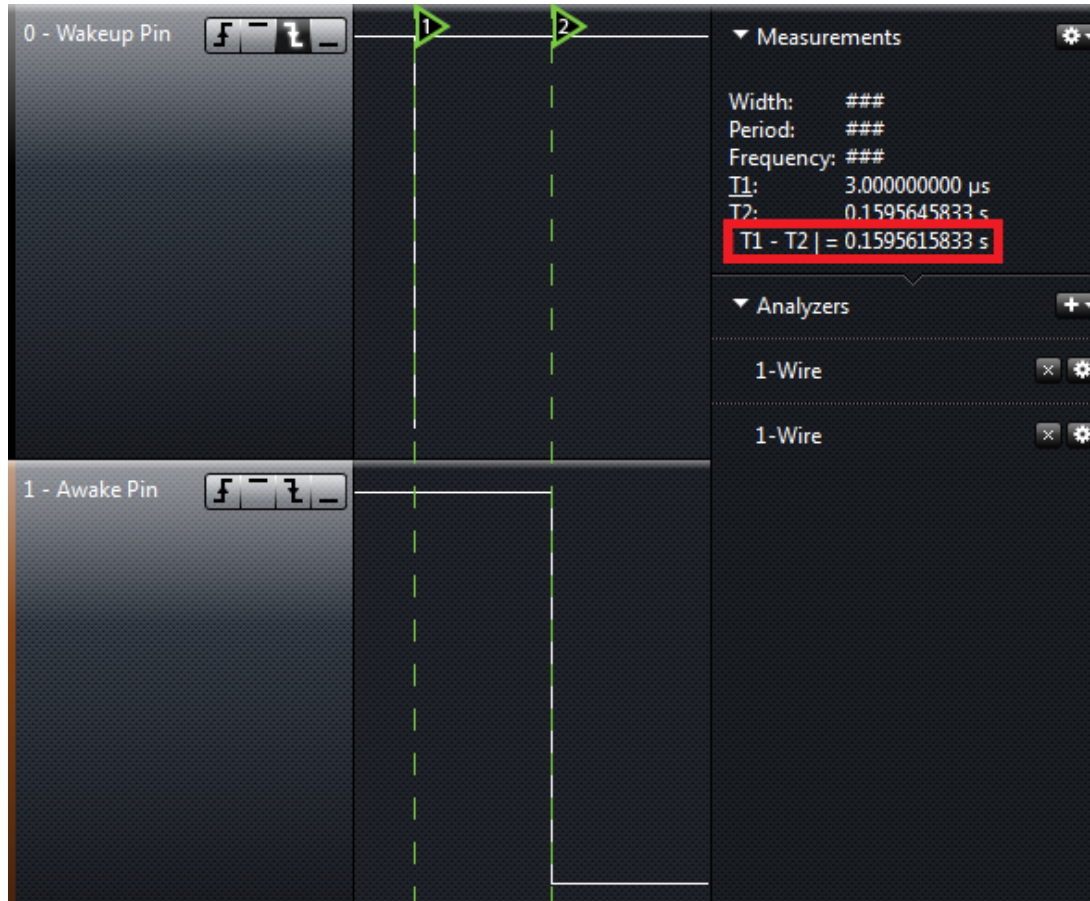

Figure 3: SaBLE-x-R2 module waking from shutdown timing diagram

Figure 3 shows the module taking approximately 160 milliseconds to wake.

1.11.2 Standby

Standby is a low power mode policy. When configured correctly in code the software goes into standby.

Figure 4 shows the response time to wake up from standby using a wake up pin. The method is the same as described in the shutdown section:

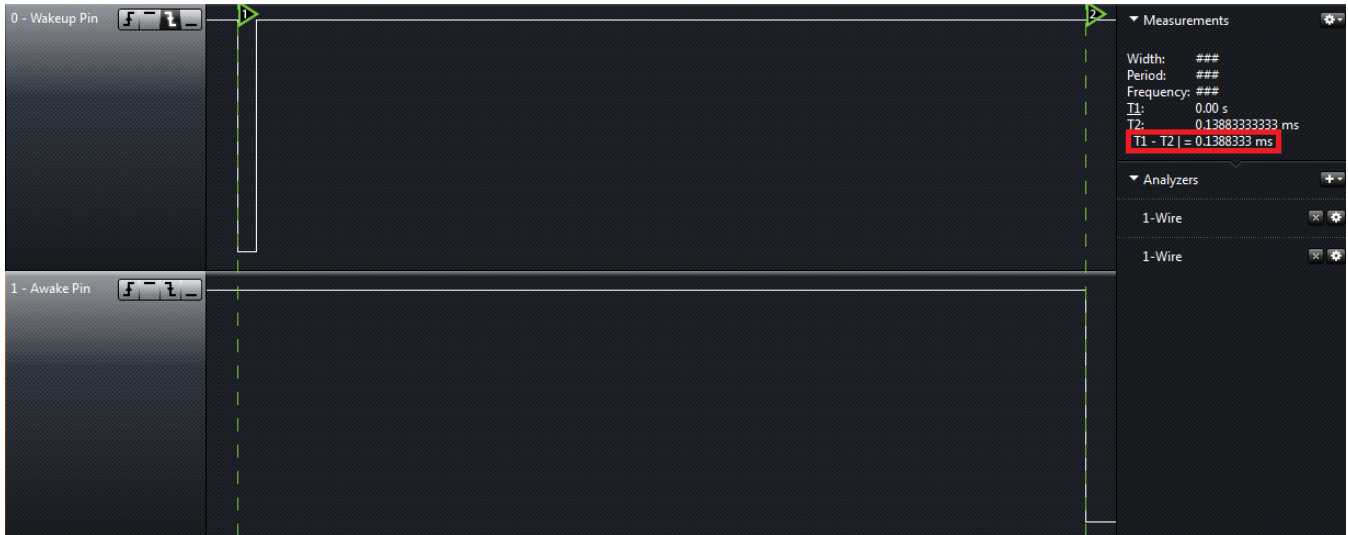

Figure 4: SaBLE-x-R2 module waking from standby timing diagram

Figure 4 shows the module taking approximately 139 μ s to wake.

2 SOLDERING RECOMMENDATIONS

2.1 Recommended Reflow Profile for Lead Free Solder

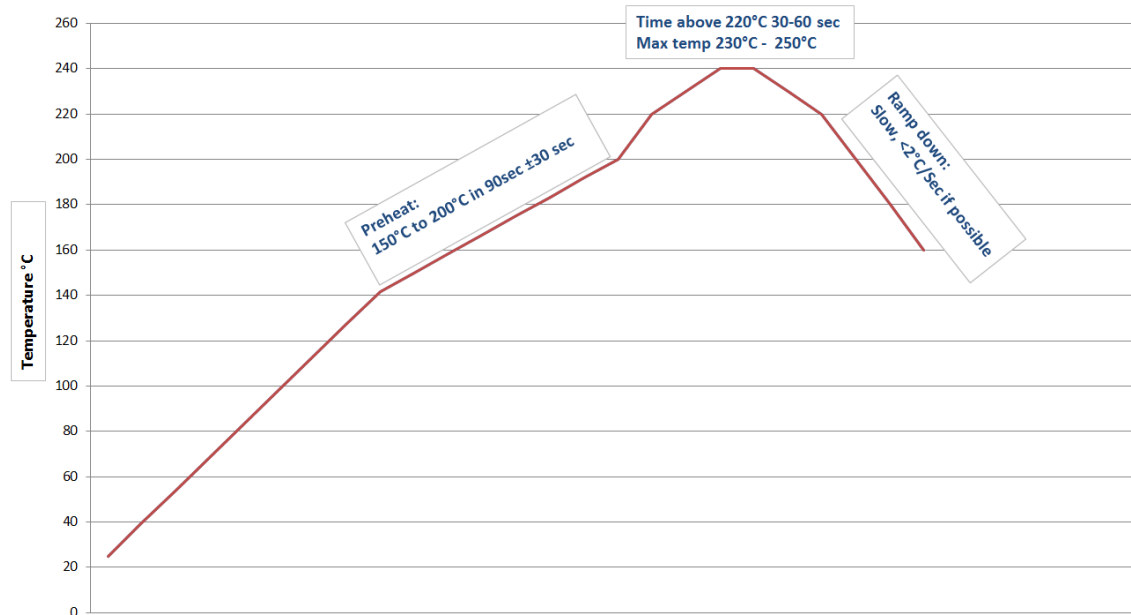

Figure 5: Recommended soldering profile

Note: The quality of solder joints on the surface mount pads where they contact the host board should meet the appropriate IPC Specification. See IPC-A-610-D Acceptability of Electronic Assemblies, section 8.2.1 *Bottom Only Terminations*.

3 CLEANING

In general, cleaning the populated modules is strongly discouraged. Residuals under the module cannot be easily removed with any cleaning process.

- Cleaning with water can lead to capillary effects where water is absorbed into the gap between the host board and the module. The combination of soldering flux residuals and encapsulated water could lead to short circuits between neighboring pads. Water could also damage any stickers or labels.
- Cleaning with alcohol or a similar organic solvent will likely flood soldering flux residuals into the RF shield, which is not accessible for post-washing inspection. The solvent could also damage any stickers or labels.
- Ultrasonic cleaning could damage the module permanently.

4 OPTICAL INSPECTION

After soldering the module to the host board, consider optical inspection to check the following:

- Proper alignment and centering of the module over the pads.
- Proper solder joints on all pads.
- Excessive solder or contacts to neighboring pads, or vias.

5 REWORK

The module can be unsoldered from the host board if the Moisture Sensitivity Level (MSL) requirements are met as described in this datasheet.

Note: Never attempt a rework on the module itself, e.g. replacing individual components. Such actions will terminate warranty coverage.

6 SHIPPING, HANDLING, AND STORAGE

6.1 Shipping

Bulk orders of the SaBLE-x-R2 modules are delivered in reels of 1,000.

6.2 Handling

The SaBLE-x-R2 modules contain a highly sensitive electronic circuitry. Handling without proper ESD protection may damage the module permanently.

6.3 Moisture Sensitivity Level (MSL)

Per J-STD-020, devices rated as MSL 4 and not stored in a sealed bag with desiccant pack should be baked prior to use.

Devices are packaged in a Moisture Barrier Bag with a desiccant pack and Humidity Indicator Card (HIC). Devices that will be subjected to reflow should reference the HIC and J-STD-033 to determine if baking is required.

If baking is required, refer to J-STD-033 for bake procedure.

6.4 Storage

Per J-STD-033, the shelf life of devices in a Moisture Barrier Bag is 12 months at <40°C and <90% room humidity (RH).

Do not store in salty air or in an environment with a high concentration of corrosive gas, such as Cl₂, H₂S, NH₃, SO₂, or NO_x.

Do not store in direct sunlight.

The product should not be subject to excessive mechanical shock.

6.5 Repeating Reflow Soldering

Note: Only a single reflow soldering process is encouraged for host boards.

7 AGENCY CERTIFICATIONS

FCC ID TFB-1005, FCC Part 15.247

IC ID 5969A-1005, RSS 247

CE Compliant to standards EN 60950-1, ETSI EN 300 328, ETSI EN 301 489-1, and ETSI 301 489-17

Giteki: Compliant to standard ARIB STD-T66 v3.7
201-170613 (PCB trace antenna)
201-170614 (External antenna)

RCM: Compliant to standard AS/NZS 4268:2017

8 AGENCY STATEMENTS

8.1 Federal Communication Commission Interference Statement

This equipment has been tested and found to comply with the limits for a Class B digital device, pursuant to Part 15 of the FCC Rules. These limits are designed to provide reasonable protection against harmful interference in a residential installation. This equipment generates uses and can radiate radio frequency energy and, if not installed and used in accordance with the instructions, may cause harmful interference to radio communications. However, there is no guarantee that interference will not occur in a particular installation. If this equipment does cause harmful interference to radio or television reception, which can be determined by turning the equipment off and on, the user is encouraged to try to correct the interference by one of the following measures:

- Reorient or relocate the receiving antenna.
- Increase the separation between the equipment and receiver.
- Connect the equipment into an outlet on a circuit different from that to which the receiver is connected.
- Consult the dealer or an experienced radio/TV technician for help.

This device complies with Part 15 of the FCC Rules. Operation is subject to the following two conditions: (1) This device may not cause harmful interference, and (2) this device must accept any interference received, including interference that may cause undesired operation.

This portable transmitter with its antenna complies with FCC/IC RF exposure limits for general population/uncontrolled exposure.

FCC CAUTION: Any changes or modifications not expressly approved by the party responsible for compliance could void the user's authority to operate this equipment.

8.2 Industry Canada Statements

Radiation Exposure Statement:

This equipment complies with Canada radiation exposure limits set forth for an uncontrolled environment. This equipment should be installed and operated with minimum distance 20cm between the radiator & your body.

This device complies with Industry Canada License-exempt RSS standard(s). Operation is subject to the following two conditions: (1) this device may not cause interference, and (2) this device must accept any interference, including interference that may cause undesired operation of the device.

To reduce potential radio interference to other users, the antenna type and its gain should be so chosen that the equivalent isotropically radiated power (e.i.r.p.) is not more than that permitted for successful communication.

This device has been designed to operate with the antenna(s) listed below, and having a maximum gain of 0 dBi (PCB Trace), 2.0 dBi (Laird Connectivity 2.4 GHz Dipole), 2.0 dBi (Laird Connectivity 2.4 GHz FlexPIFA), 2.0 dBi (Laird Connectivity 2.4 GHz FlexNotch), and 2.0 (Laird Connectivity 2.4 GHz mFlexPIFA). Antennas not included in this list or having a gain greater than 0 dB, 2.0 dBi, 2.0 dBi, 2.0 dBi, and 2.0 dBi are strictly prohibited for use with this device. The required antenna impedance is 50 ohms.

List of all Antennas Acceptable for use with the Transmitter

- On module PCB trace antenna.
- Laird Connectivity 001-0001 center-fed 2.4 GHz dipole antenna and Laird Connectivity 080-0001 U.FL to Reverse Polarity SMA connector cable.
- Laird Connectivity 001-0014 2.4 GHz FlexPIFA antenna.
- Laird Connectivity 001-0015 2.4 GHz FlexNotch antenna.
- Laird Connectivity 001-0030 2.4 GHz Metal FlexPIFA (mFlexPIFA) antenna.

Déclaration d'exposition aux radiations:

Cet équipement est conforme Canada limites d'exposition aux radiations dans un environnement non contrôlé. Cet équipement doit être installé et utilisé à distance minimum de 20cm entre le radiateur et votre corps.

Cet appareil est conforme aux normes d'Industrie Canada exempts de licence RSS (s). L'opération est soumise aux deux conditions suivantes: (1) cet appareil ne peut pas provoquer d'interférences et (2) cet appareil doit accepter toute interférence, y compris les interférences qui peuvent causer un mauvais fonctionnement de l'appareil.

Pour réduire le risque d'interférence aux autres utilisateurs, le type d'antenne et son gain doivent être choisis de manière que la puissance isotrope rayonnée équivalente (PIRE) ne dépasse pas celle permise pour une communication réussie.

Cet appareil a été conçu pour fonctionner avec l'antenne (s) ci-dessous, et ayant un gain maximum de 0 dBi (PCB Trace), 2,0 dBi (Laird Connectivity 2.4 GHz Dipole), 2,0 dBi (Laird Connectivity 2.4 GHz FlexPIFA), 2,0 dBi (Laird Connectivity 2.4 GHz FlexNotch), et 2,0 dBi (Laird Connectivity 2.4 GHz mFlexPIFA). Antennes pas inclus dans cette liste ou présentant un gain supérieur à 0 dBi, 2,0 dBi, 2,0 dBi, 2,0 dBi, et 2,0 dBi sont strictement interdites pour une utilisation avec cet appareil. L'impédance d'antenne requise est de 50 ohms.

Liste de toutes les antennes acceptables pour une utilisation avec l'émetteur

- Le module d'antenne PCB trace.
- Laird Connectivity 001-0001 centre-fed 2,4 GHz antenne dipôle et Laird Connectivity 080-0001 U.FL pour inverser câble connecteur SMA à polarité.
- Laird Connectivity 001-0014 antenne FlexPIFA 2,4 GHz.
- Laird Connectivity 001-0015 antenne FlexNotch 2,4 GHz.
- Laird Connectivity 001-0030 antenne Métal FlexPIFA (mFlexPIFA) 2,4 GHz

8.3 OEM Responsibilities to Comply with FCC and Industry Canada Regulations

The SaBLE-x-R2 module has been certified for integration into products only by OEM integrators under the following conditions:

The antennas for this transmitter must not be co-located with any other transmitters except in accordance with FCC and Industry Canada multi-transmitter procedures.

As long as the two conditions above are met, further transmitter testing will not be required. However, the OEM integrator is still responsible for testing their end-product for any additional compliance requirements required with this module installed (for example, digital device emissions, PC peripheral requirements, etc.).

IMPORTANT NOTE: In the event that these conditions cannot be met (for certain configurations or co-location with another transmitter), then the FCC and Industry Canada authorizations are no longer considered valid and the FCC ID and IC Certification Number cannot be used on the final product. In these circumstances, the OEM integrator will be responsible for re-evaluating the end product (including the transmitter) and obtaining a separate FCC and Industry Canada authorization.

Le module de SaBLE-x-R2a été certifié pour l'intégration dans des produits uniquement par des intégrateurs OEM dans les conditions suivantes:

Les antennes pour ce transmetteur ne doit pas être co-localisés avec les autres émetteurs sauf en conformité avec la FCC et Industrie Canada multi-émetteur procédures..

Tant que les deux conditions précitées sont réunies, les tests de transmetteurs supplémentaires ne seront pas tenus. Toutefois, l'intégrateur OEM est toujours responsable de tester leur produit final pour toutes les exigences de conformité supplémentaires requis avec ce module installé (par exemple, les émissions appareil numérique, les exigences de périphériques PC, etc.)

NOTE IMPORTANTE: Dans le cas où ces conditions ne peuvent être satisfaites (pour certaines configurations ou de co-implantation avec un autre émetteur), puis la FCC et Industrie autorisations Canada ne sont plus considérés comme valides et l'ID de la FCC et IC numéro de certification ne peut pas être utilisé sur la produit final. Dans ces circonstances, l'intégrateur OEM sera chargé de réévaluer le produit final (y compris l'émetteur) et l'obtention d'un distincte de la FCC et Industrie Canada l'autorisation.

OEM Labeling Requirements for End-Product

The SaBLE-x-R2 module is labeled with its own FCC ID and IC certification number. The FCC ID and IC certification numbers are not visible when the module is installed inside another device. As such, the end device into which the module is installed must display a label referring to the enclosed module. The end product must be labeled in a visible area with the following:

Contains Transmitter Module FCC ID: TFB-1005

Contains Transmitter Module IC: 5969A-1005

or

Contains FCC ID: TFB-1005

Contains IC: 5969A-1005

The OEM of the SaBLE-x-R2 module must only use the approved antenna(s) listed above, which have been certified with this module.

Le module de SaBLE-x-R2 est étiqueté avec son propre ID de la FCC et IC numéro de certification. L'ID de la FCC et IC numéros de certification ne sont pas visibles lorsque le module est installé à l'intérieur d'un autre appareil, comme par exemple le terminal dans lequel le module est installé doit afficher une étiquette faisant référence au module ci-joint. Le produit final doit être étiqueté dans un endroit visible par le suivant:

Contient Module émetteur FCC ID: TFB-1005

Contient Module émetteur IC: 5969A-1005

ou

Contient FCC ID: TFB-1005

Contient IC: 5969A-1005

Les OEM du module SaBLE-x-R2 ne doit utiliser l'antenne approuvée (s) ci-dessus, qui ont été certifiés avec ce module.

8.4 OEM End Product User Manual Statements

The OEM integrator should not provide information to the end user regarding how to install or remove this RF module or change RF related parameters in the user manual of the end product.

Other user manual statements may apply.

L'intégrateur OEM ne devraient pas fournir des informations à l'utilisateur final sur la façon d'installer ou de supprimer ce module RF ou modifier les paramètres liés RF dans le manuel utilisateur du produit final.

Autres déclarations manuel de l'utilisateur peuvent s'appliquer.

9 EUROPE

9.1 CE Notice

This device has been tested and certified for use in the European Union. See the Declaration of Conformity (DoC) for specifics (available on the applicable product page of the Laird website).

If this device is used in a product, the OEM has responsibility to verify compliance of the final product to the EU standards. A Declaration of Conformity must be issued and kept on file as described in the 2014/53/EU – Radio Equipment Directive (RED).

The CE mark must be placed on the OEM product per the labeling requirements of the directive.

10 AUSTRALIA

10.1 RCM

Table 14: AS/NZS certification

**Radio Equipment and Systems (Short Range Devices) Standard 2014 (Amnt 1:2015)
Radiocommunications (Low Interference Potential Device) Class License 2015**

AS/NZS 4268: 2017
EN 300 328 v2.1.1 (2016-11)
Report No.: AR742502, Dated: 25 April 2017, International Certification Corp.

Radiocommunications (Electromagnetic Radiation – Human Exposure) Standard 2014

AS/NZS 2772.2:2011
Report No.: AA742502, Dated: 25 April 2017, International Certification Corp.
Maximum Exposure Levels to Radio Frequency Fields – 3 KHz to 300 GHz (2002) RPS 3, ARPANSA
Category B Exemption – Fixed Station Exemption, ARPANSA Schedule 5, General Public Exposure, <20mW Mean Power,
Or no antenna near the body (>20 cm from unaware user) and mean output power does not exceed Table 2 threshold for testing.

If this device is used in a product, the OEM has the responsibility to verify the compliance of the final end product to the Australia/New Zealand (RCM) Standards. All end-products require their own certification (SDoc). You cannot leverage the module certification and ship product into the country.

11 BLUETOOTH SIG QUALIFICATION

The SaBLE-x-R2 module is listed on the Bluetooth SIG website as a *Component Tested* design. Its intended use is integration into a new End Product design by a third-party SIG member.

Design Name	Owner	Declaration ID	QD ID	Link to listing on the SIG website
SaBLE-x-R2	Laird Technologies	D035147	96853	https://www.bluetooth.org/tpg/QLI_viewQDL.cfm?qid=35147

It is a mandatory requirement of the Bluetooth Special Interest Group (SIG) that every product implementing Bluetooth technology has a Declaration ID. Every Bluetooth design is required to go through the qualification process, even when referencing a Bluetooth design that already has its own Declaration ID. The qualification process requires each company to be registered as a member of the Bluetooth SIG – www.bluetooth.org

The following link provides a link to the Bluetooth Registration page: <https://www.bluetooth.org/login/register/>

For each Bluetooth design it is necessary to purchase a Declaration ID. This can be done before starting the new qualification, either through invoicing or credit card payment. The fees for the Declaration ID depend on your membership status. Please refer to the following webpage:

<https://www.bluetooth.org/en-us/test-qualification/qualification-overview/fees>

For a detailed procedure of how to obtain a new Declaration ID for your design, please refer to the following SIG document:

https://www.bluetooth.org/DocMan/handlers/DownloadDoc.ashx?doc_id=283698&vId=317486

11.1 Qualification Steps When Combining with a Laird Component

If you wish to use a Laird component in your end product, the qualification process follows the *Traditional Project* route, creating a completely new design. When creating a new design, it is necessary to complete the full qualification listing process and maintain a compliance folder for the new design.

The SaBLE-x-R2 design under D035147 incorporates the following Texas Instrument component;

Listing reference	Design Name	Core Spec Version
D035408 (RF-PHY)	CC2640R2F SimpleLink™ Bluetooth® 5.0 low energy Wireless MCU	5.0

If your design is based on un-modified SaBLE-x-R2 hardware, it is possible to use the following process;

1. Reference the existing RF-PHY test report from the SaBLE-x-R2 listing.
2. Combine the relevant Texas Instruments component(s) – covering as a minimum LL, L2CAP, GAP, ATT, GATT, SM). Check relevant QDID with Texas Instruments\Laird.
Example component is Texas Instruments [D033411](#))
3. Test on PTS any standard SIG profiles that are supported in the design. Customs profiles are exempt.

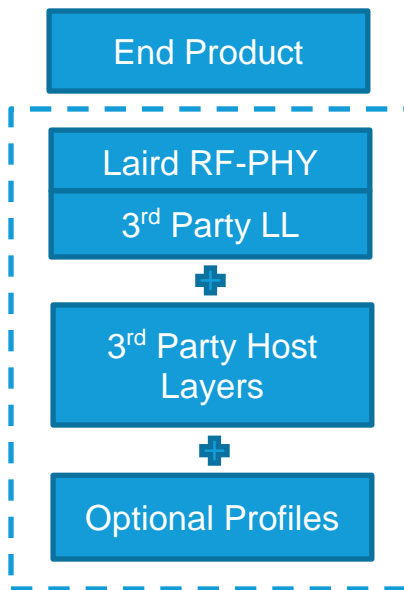

Figure 6: End Product design qualification scope

Figure 6 shows the scope of the qualification for an End Product Design.

The first step is to generate a project on the TPG (Test Plan Generator) system. This determines which test cases apply to demonstrate compliance with the Bluetooth Test Specifications. When combining qualified components in your design, and they are within their 3-year listing period, you are not required to re-test those layers covered by those components.

If the design incorporates any standard SIG LE profiles (such as the Heart Rate Profile), it is necessary to test these profiles using PTS or other tools where permitted; the results are added to the compliance folder.

You must upload your test declaration and test reports (where applicable) and then complete the final listing steps on the SIG website.

Note: Remember to purchase your Declaration ID before you start the qualification process, as it is not possible to complete the listing without it.

For further information please refer to the following training material:

<https://www.bluetooth.org/en-us/test-qualification/qualification-overview/listing-process-updates>

If you require assistance with the qualification process, please contact our recommended Bluetooth Qualification Expert (BQE), Steve Flocks, steve.flock@eurexuk.com.

12 ANTENNA INFORMATION

12.1 Laird Connectivity Dipole Antenna

See antenna datasheet.

12.2 Laird Connectivity FlexPIFA

See antenna datasheet.

12.3 Laird Connectivity FlexNotch

See antenna datasheet.

12.4 Laird Connectivity mFlexPIFA

See antenna datasheet.

12.5 PCB Trace Antenna

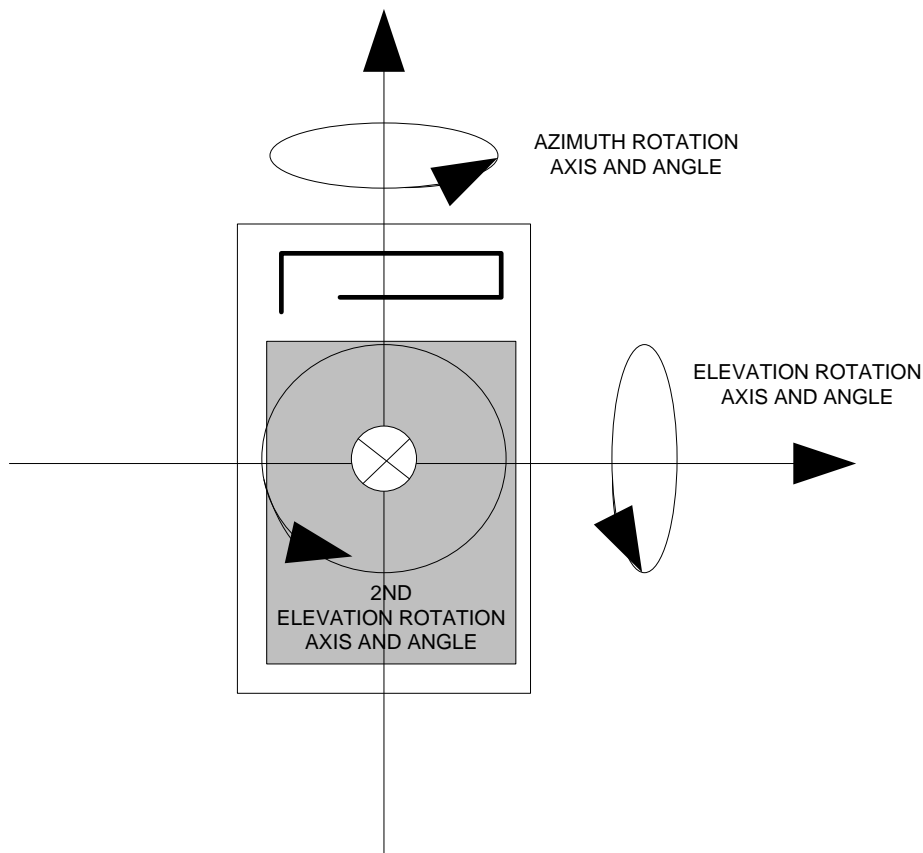

Figure 7: PCB trace antenna pattern measurement planes

Table 15: PCB trace antenna gain summary

Orientation	Frequency (MHz)	Polarization	Peak Gain (dBi)	Average Gain (dBi)	Average Total Gain (P) (dBi)	Average Total Gain (F, P) (dBi)	Average Total Gain (O, F, P) (dBi)
Azimuth	2402	Vertical	0.0	-3.6	-3.0	-4.6	-5.9
Azimuth	2402	Horizontal	-6.6	-12.4			
Azimuth	2440	Vertical	-1.7	-5.1	-4.5		
Azimuth	2440	Horizontal	-1.7	-13.4			
Azimuth	2480	Vertical	-4.3	-7.9	-7.3		
Azimuth	2480	Horizontal	-11.5	-15.9			
Elevation	2402	Vertical	-7.3	-11.4	-4.7		
Elevation	2402	Horizontal	-1.2	-5.7			
Elevation	2440	Vertical	-7.9	-12.6	-5.6		
Elevation	2440	Horizontal	-7.9	-6.6			
Elevation	2480	Vertical	-11.0	-15.9	-8.3		
Elevation	2480	Horizontal	-4.2	-9.1			
2 nd Elevation	2402	Vertical	-9.4	-14.8	-6.6		
2 nd Elevation	2402	Horizontal	-2.8	-7.3			
2 nd Elevation	2440	Vertical	-10.3	-16.6	-7.3		
2 nd Elevation	2440	Horizontal	-3.4	-7.9			
2 nd Elevation	2480	Vertical	-12.8	-18.9	-9.8		
2 nd Elevation	2480	Horizontal	-6.0	-10.4			

Vertical, Horizontal Antenna Patterns at 2402 MHz (dB) – Azimuth Cut

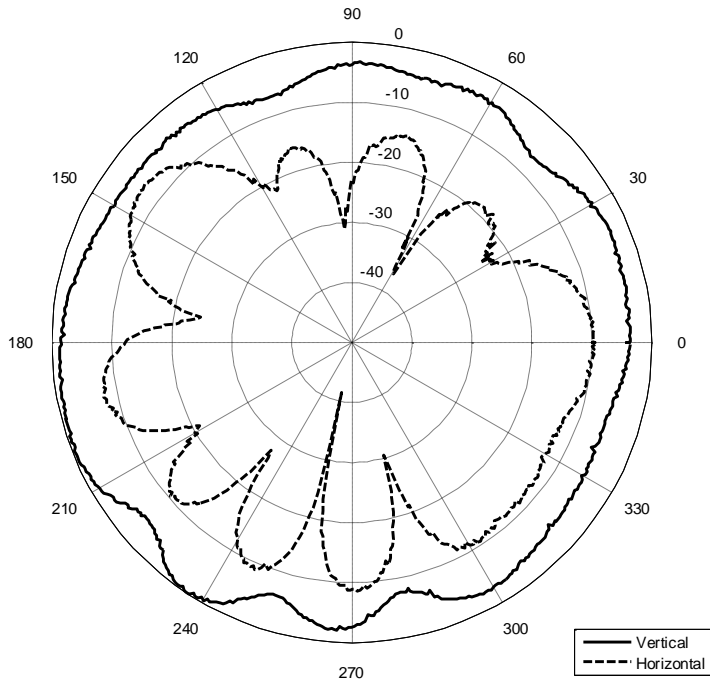

Figure 8: PCB Trace Antenna Pattern (Azimuth @ 2402 MHz)

Vertical, Horizontal Antenna Patterns at 2402 MHz (dB) – Elevation Cut

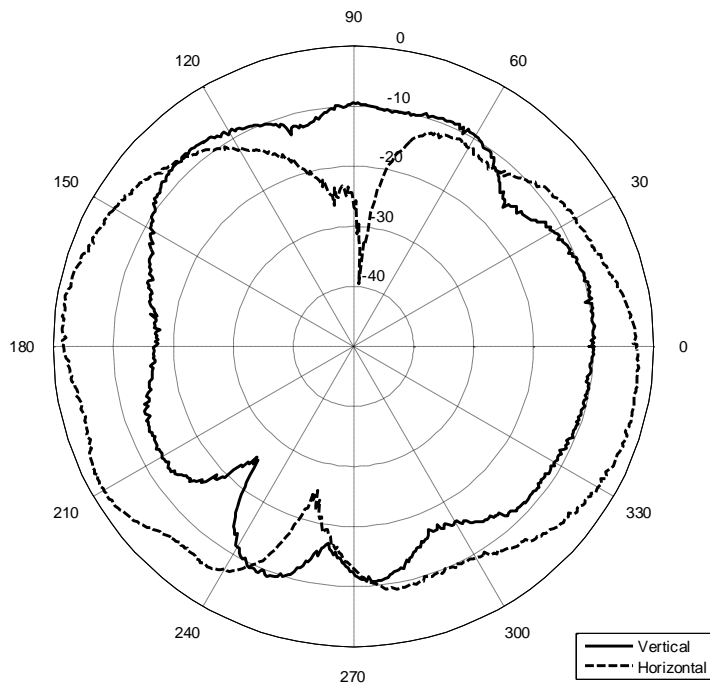

Figure 9: PCB Trace Antenna Pattern (Elevation @ 2402 MHz)

Vertical, Horizontal Antenna Patterns at 2402 MHz (dB) – Second Elevation Cut

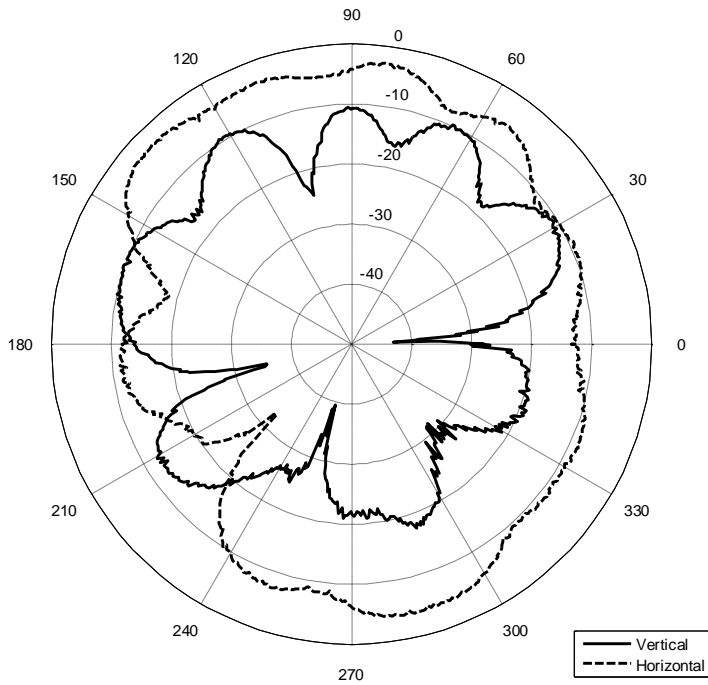

Figure 10: PCB Trace Antenna Pattern (2nd Elevation @ 2402 MHz)

Vertical, Horizontal Antenna Patterns at 2440 MHz (dB) – Azimuth Cut

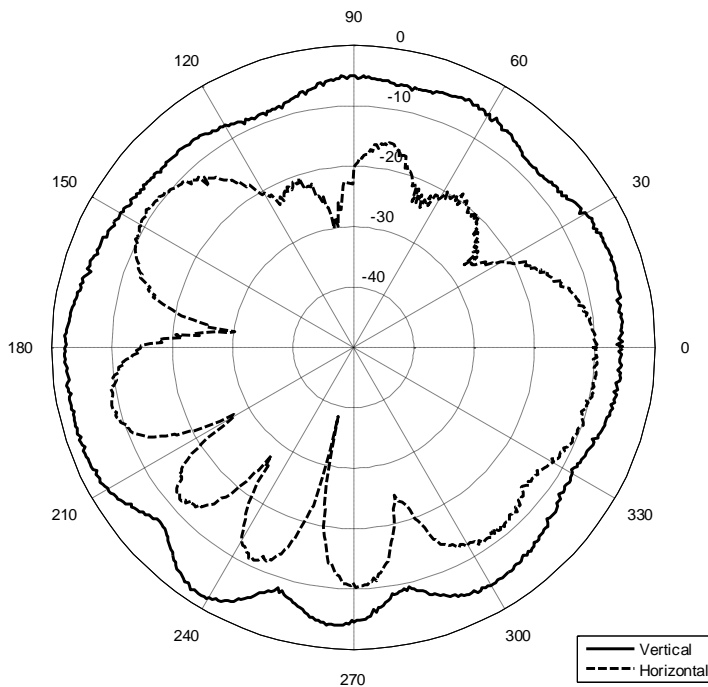

Figure 11: PCB Trace Antenna Pattern (Azimuth @ 2440 MHz)

Vertical, Horizontal Antenna Patterns at 2440 MHz (dB) – Elevation Cut

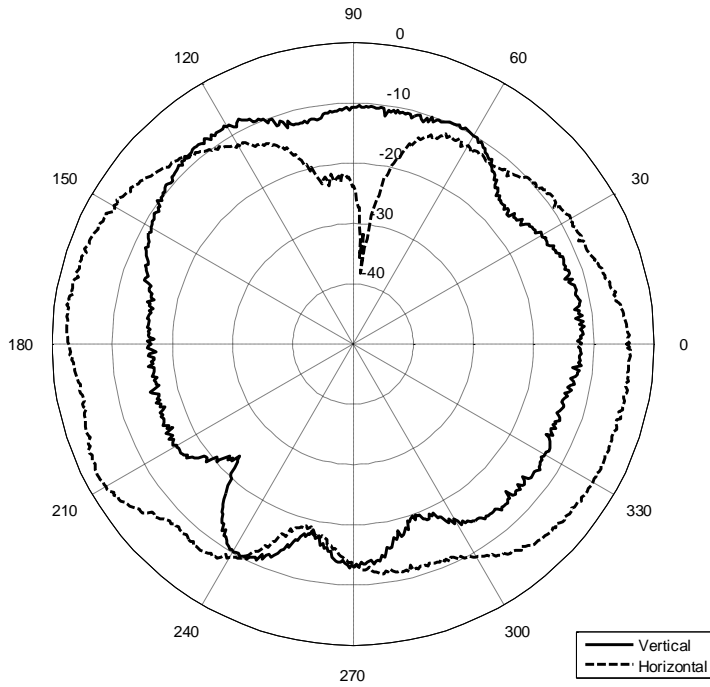

Figure 12: PCB Trace Antenna Pattern (Elevation @ 2440 MHz)

Vertical, Horizontal Antenna Patterns at 2440 MHz (dB) – Second Elevation Cut

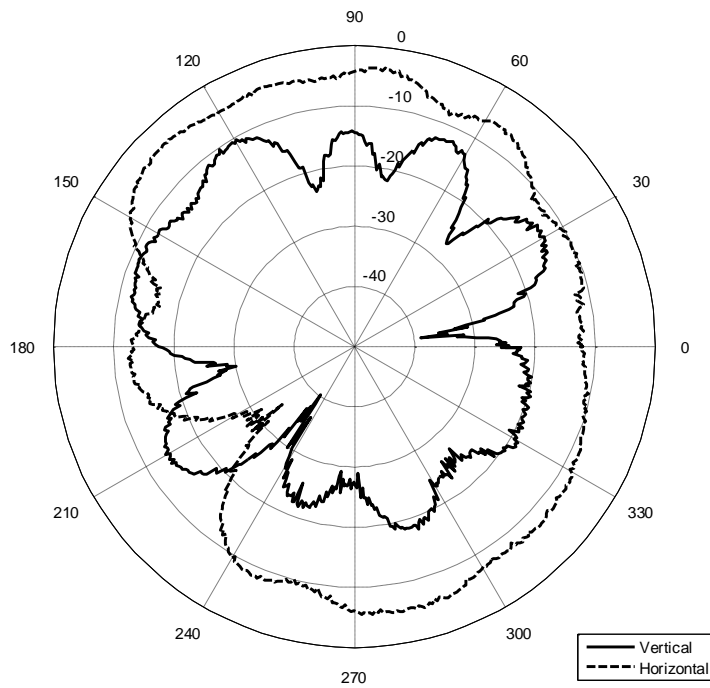

Figure 13: PCB Trace Antenna Pattern (2nd Elevation @ 2440 MHz)

Vertical, Horizontal Antenna Patterns at 2480 MHz (dB) – Azimuth Cut

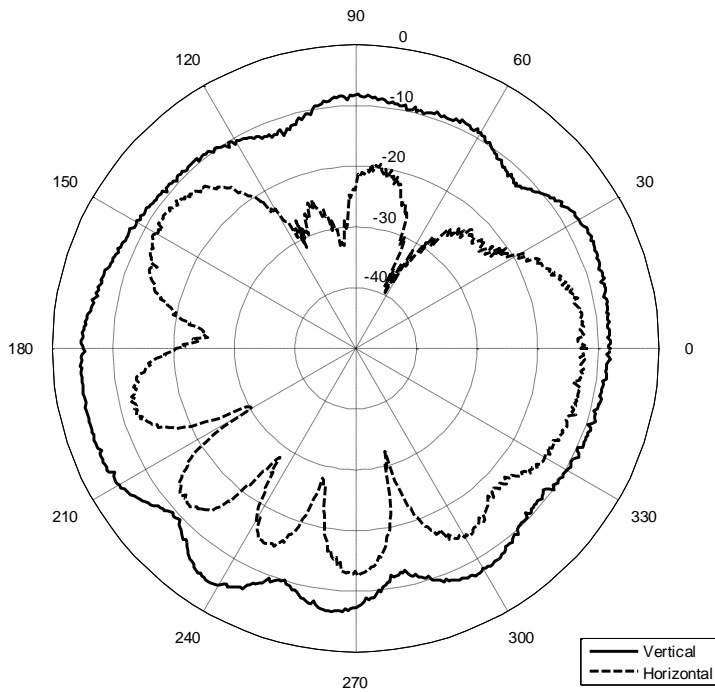

Figure 14: PCB Trace Antenna Pattern (Azimuth @ 2480 MHz)

Vertical, Horizontal Antenna Patterns at 2480 MHz (dB) – Elevation Cut

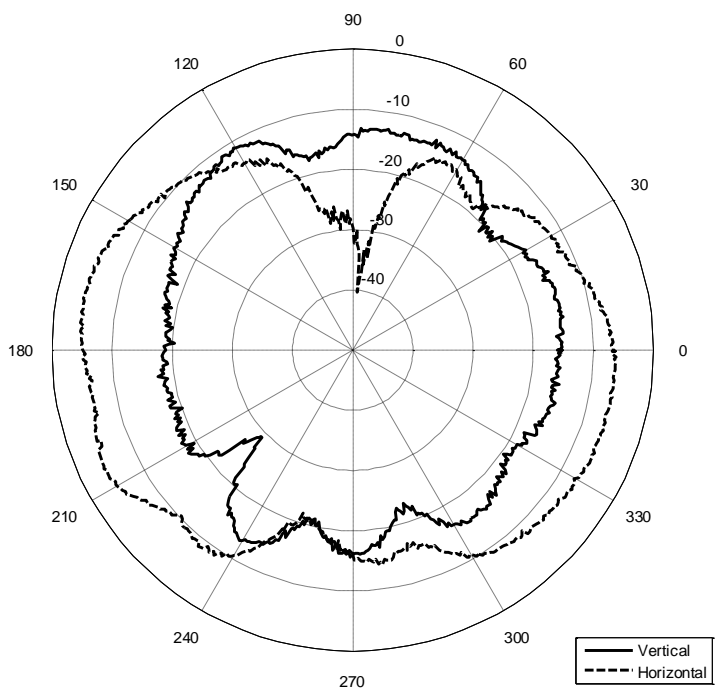

Figure 15: PCB Trace Antenna Pattern (Elevation @ 2480 MHz)

Vertical, Horizontal Antenna Patterns at 2480 MHz (dB) – Second Elevation Cut

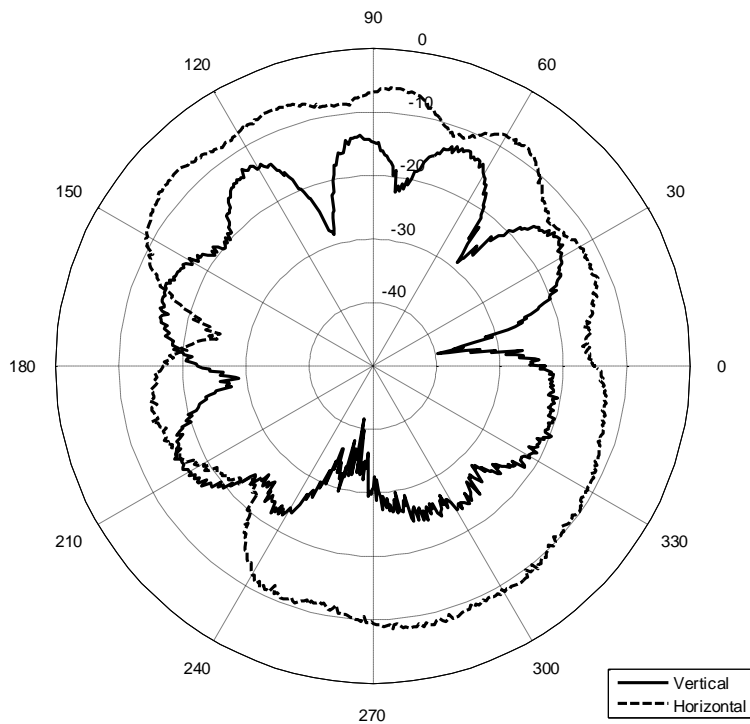

Figure 16: PCB Trace Antenna Pattern (2nd Elevation @ 2480 MHz)

13 MECHANICAL DATA

The following are the mechanical dimensions of the SaBLE-x-R2 module.

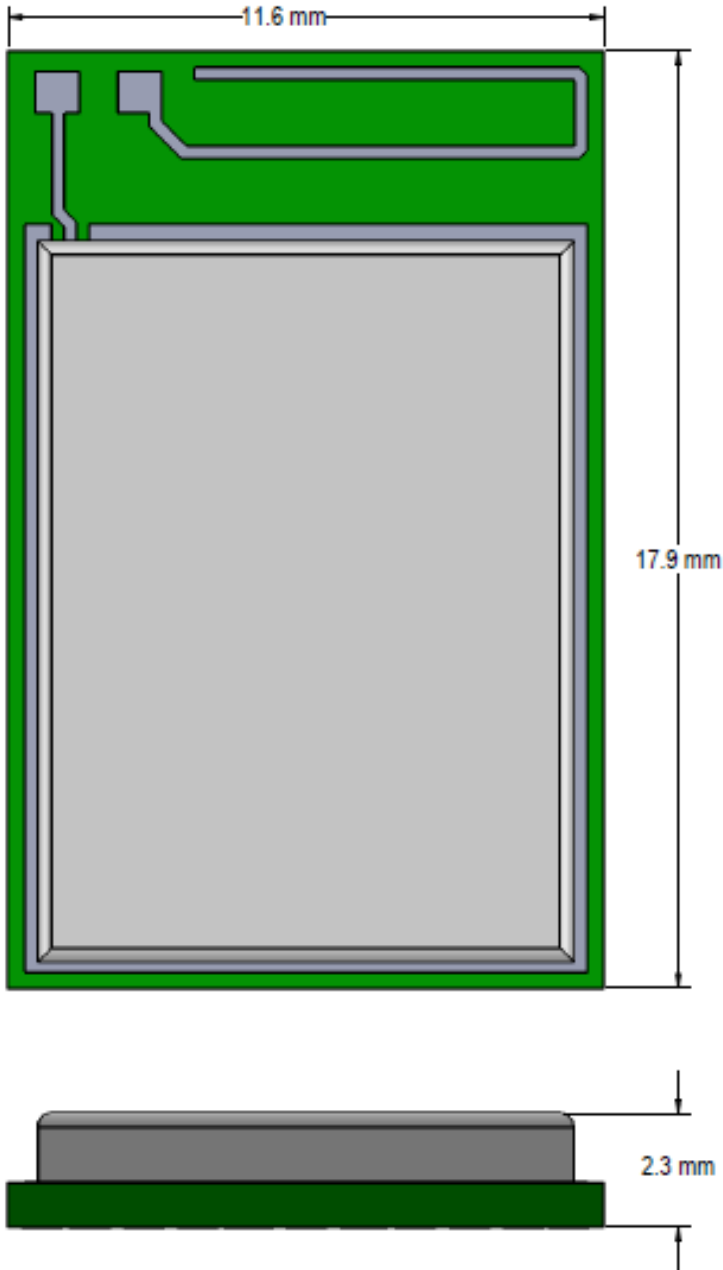

Figure 17: Module Mechanical Dimensions (Maximum Module Height = 2.4mm)

14 PCB FOOTPRINT

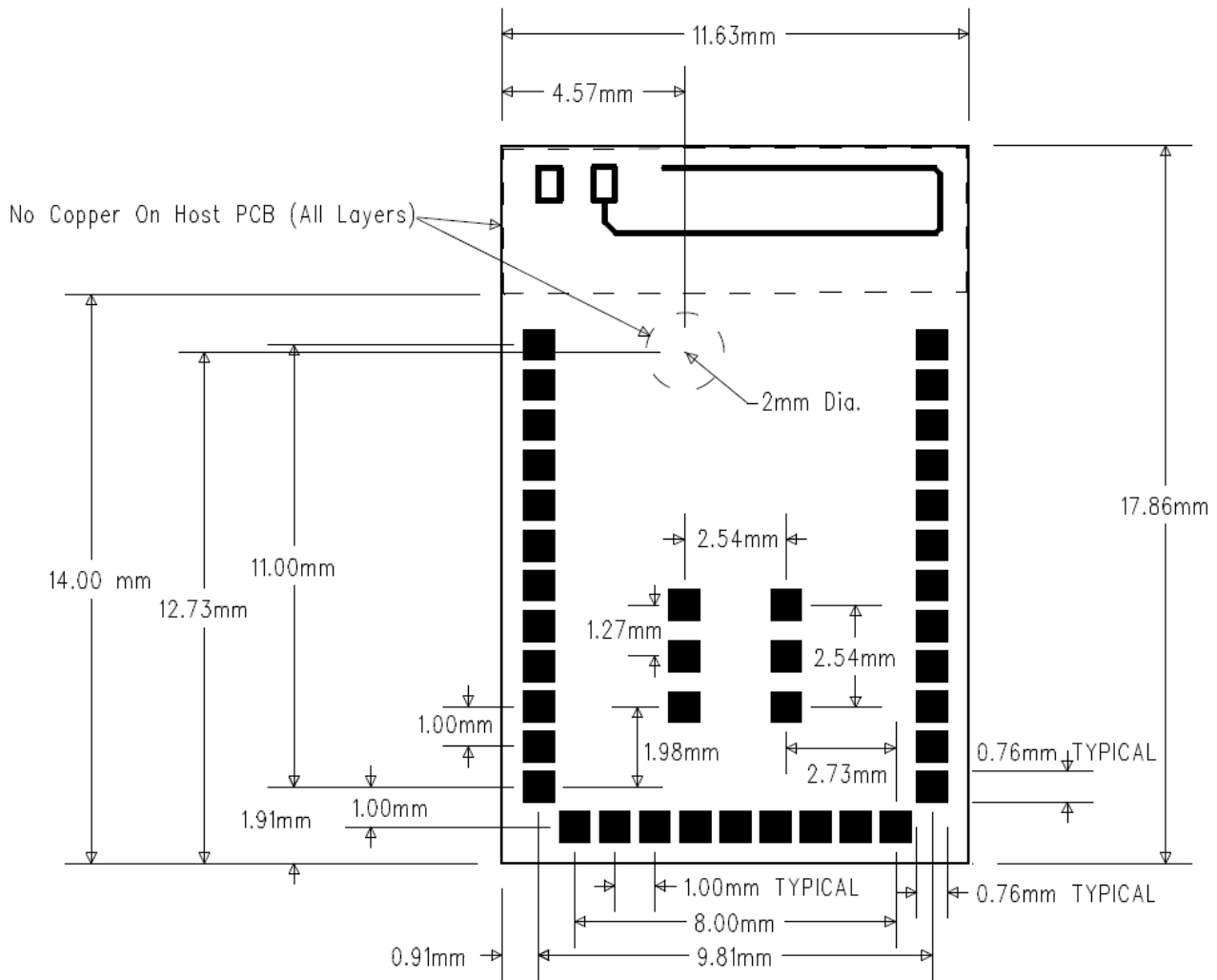
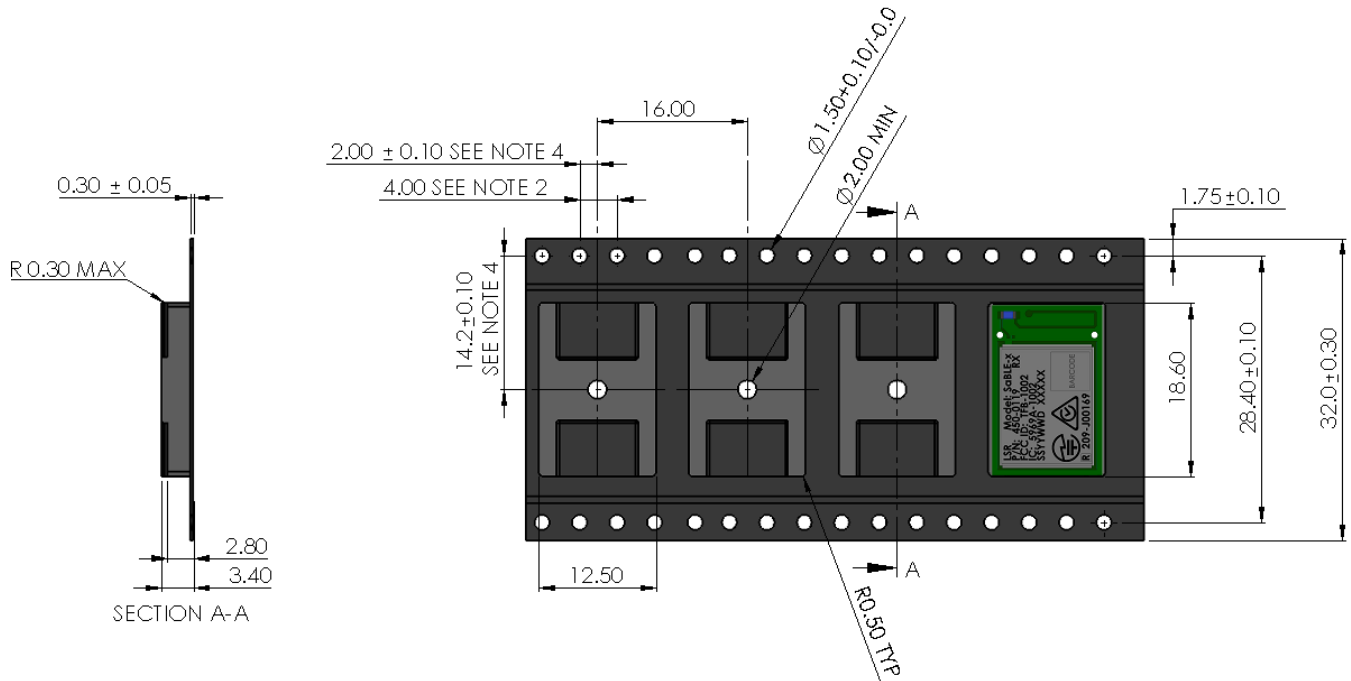

Figure 18: SaBLE-x-R2 Recommended PCB Footprint (Viewed from Top)

14.1 Tape and Reel Dimensions

Tape Dimensions



NOTES:

1. DIM in mm.
2. 10 Sprocket Hole Pitch Cumulative Tolerance ± 0.2 mm.
3. Camber in Compliance with EIA 481.
4. Pocket Position Relative to Sprocket Hole Measured as True Position of Pocket, not Pocket Hole
5. A Full Reel contains 1000 Modules

Note: Module must be in this orientation when feeding tape.

Figure 19: Tape and reel specification

15 DEVICE MARKINGS

15.1 450-0177 and 450-0178

15.1.1 Rev 1 Devices

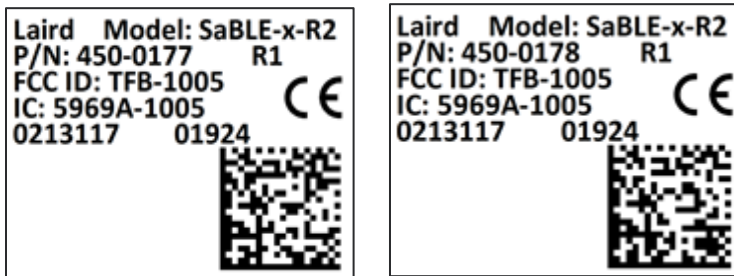

The shield on the 450-0177/450-0178 modules contains the following information:

- Laird Model: SaBLE-x-R2
- Part Number and Revision:
 - Part Number: 450-0177 or 450-0178
 - Revision: -RX (where X is the latest revision)
- FCC ID: TFB-1005
- IC: 5969A-1005
- SYYWWD = Date Code (YY=Year, WW=Week)
- XXXXX = Incremental Serial Number
- 2D Barcode Format is Data Matrix Standard

15.1.2 Rev 2 Devices

Added Giteki and C-Tick Certification

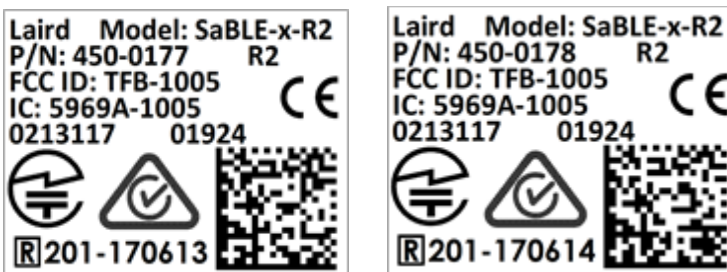

The shield on the 450-0177/450-0178 modules contains the following additional information:

-  C-Tick Logo (Australia and New Zealand Certification)
-  Giteki Logo (Japan Certification)
 -  Symbol of Radio Certification
 - **201** CAB ID assigned by Minister of MIC
 - **170613** (450-0177) or **170614** (450-0178) Certification number assigned by the CAB.

15.2 450-0194 and 450-0195

15.2.1 Rev 1 Devices

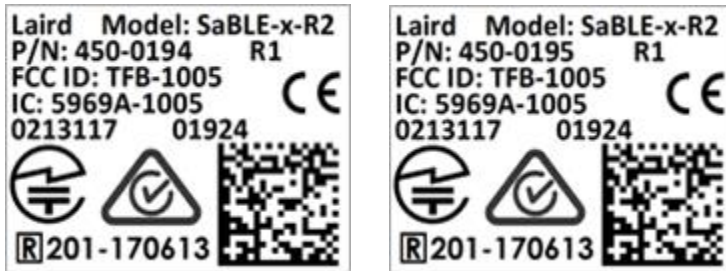

The shield on the 450-0194/450-0195 modules contains the following information:

- Laird Model: SaBLE-x-R2
- Part Number and Revision:
 - Part Number: 450-0194 or 450-0195
 - Revision: -RX (where X is the latest revision)
- FCC ID: TFB-1005
- IC: 5969A-1005
- SSYYWWD = Date Code (YY=Year, WW=Week)
- XXXXX = Incremental Serial Number
- 2D Barcode Format is Data Matrix Standard

-  C-Tick Logo (Australia and New Zealand Certification)

-  Giteki Logo (Japan Certification)

-  Symbol of Radio Certification
- **201** CAB ID assigned by Minister of MIC
- **170613** (450-0177) or **170614** (450-0178) Certification number assigned by the CAB.

16 CONTACTING LAIRD

Website	https://www.lairdconnect.com/
Technical Support	https://www.lairdconnect.com/resources/support support@lairdconnect.com
Sales Contact	sales@lairdconnect.com

Mouser Electronics

Authorized Distributor

Click to View Pricing, Inventory, Delivery & Lifecycle Information:

[Laird Connectivity:](#)

[450-0177C](#) [450-0177R](#) [450-0178R](#) [450-0178C](#)