

REV.	ECN NO.	DATE	SIGN	DESCRIPTION
B	LEN1580130~141	2015/08/10	Feng_Li	Add Black PVC Cable
C	LEN1680943~960 LEN1681003~011	2016/08/09	Yulong_wang	Add 6Pin & IP69K.
D	LEN1750089~96	2017/04/06	Lingpeng	Change The Cable OD

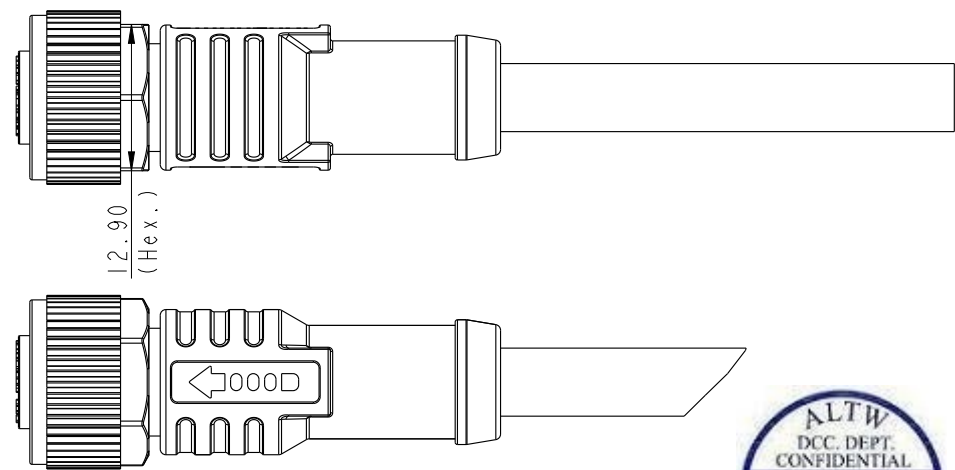

- Notes:
- \*  $\varnothing$  Important Dimension.
  - \* Waterproof Rate: IP68, IP69K.
  - \* Connector: PU+GF, Black.
  - \* Female Pin: Copper Alloy, Gold Plated.
  - \* Screw Nut: Zinc Alloy, Nickel Plated.
  - \* Outer Mold: PU, Black.
  - \* Cable: (A) UL2517, PVC Jacket, Yellow.  
(B) UL20549, PUR Jacket, Black.  
(D) UL2517, PVC Jacket, Black.
  - \* Rated Voltage: 3 & 4Pin 250V dc. or ac.  
5Pin 60V dc. or ac.  
6~12Pin 30V dc. or ac.
  - \* Rated Current: 3~5Pin 4A  
6~8Pin 2A  
10~12Pin 1.5A
  - \* Operating Temperature: -25~85°C
  - \* Cable Length Tolerance: 01M:±40mm  
02M~05M:±60mm  
06M~10M:±100mm  
11M~30M:±200mm  
31M~99M:±500mm

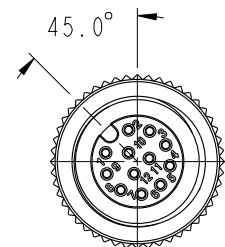
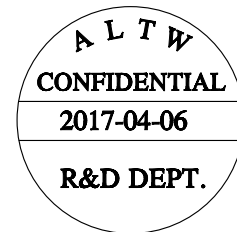
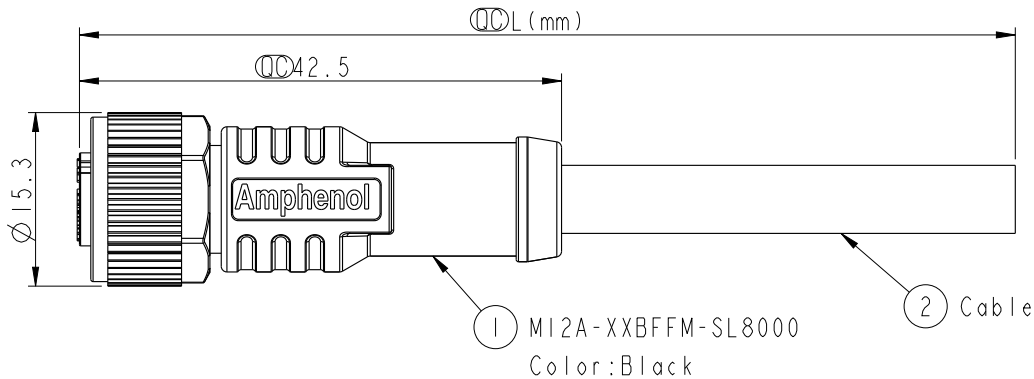

UNIT: mm		
TOLERANCE		
±0.5mm		

TITLE M12 A Type Cable Female Conn.			
SCALE 3:2	SIZE A4	SHEET 1 OF 3	
REV. D	WC-REV. A.3	$\varnothing$ : Inspection item	

**Amphenol LTW**  
安費諾亮泰企業股份有限公司

ITEM NO	DRAWN BY Lingpeng	DATE 2017-04-06
DWG NO M12A-XXBFFM-SL8XXX	CHECKED BY Ma Fei	DATE 2017-04-06
CUSTOMER ALTW	APPROVED BY Jerry	DATE 2017-04-06

THIS DOCUMENT IS SUBJECT TO CHANGE WITHOUT NOTICE. IT IS CONFIDENTIAL AND A PROPERTY OF Amphenol LTW. DISCLOSURE TO THIRD PARTY HAS TO BE AUTHORIZED BY Amphenol LTW.

F  
E  
D  
C  
B  
A

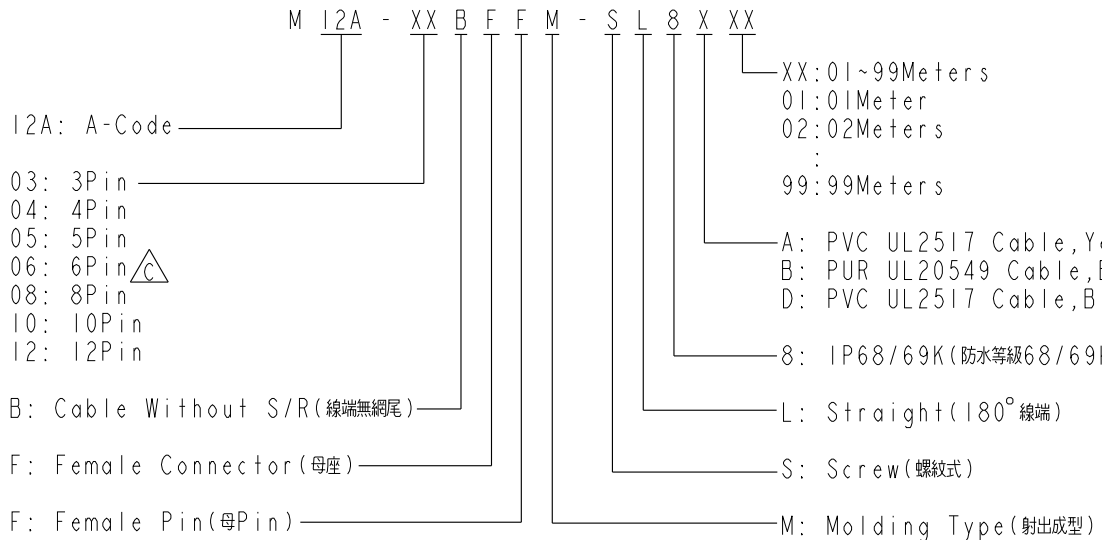

Contacts	Cable Jacket	Cable OD	AWG	Item No.		
	PVC	12P	6.0	26	M12A-12BFFM-SL8DXX	
		10P	5.5	24	M12A-10BFFM-SL8DXX	
8P		M12A-08BFFM-SL8DXX				
		6P	5.0	22	M12A-06BFFM-SL8DXX	
		5P	5.1		M12A-05BFFM-SL8DXX	
		4P	4.8	22	M12A-04BFFM-SL8DXX	
		3P	4.5		M12A-03BFFM-SL8DXX	
		PUR	12P	6.0	26	M12A-12BFFM-SL8BXX
			10P	4.8	24	M12A-10BFFM-SL8BXX
8P			M12A-08BFFM-SL8BXX			
	6P		5.0	22	M12A-06BFFM-SL8BXX	
	5P		4.4		M12A-05BFFM-SL8BXX	
	4P		4.0	22	M12A-04BFFM-SL8BXX	
	3P		3.8		M12A-03BFFM-SL8BXX	
	PVC		12P	6.0	26	M12A-12BFFM-SL8AXX
			10P	5.5	24	M12A-10BFFM-SL8AXX
8P			M12A-08BFFM-SL8AXX			
		6P	5.0	22	M12A-06BFFM-SL8AXX	
		5P	5.1		M12A-05BFFM-SL8AXX	
		4P	4.8	22	M12A-04BFFM-SL8AXX	
		3P	4.5		M12A-03BFFM-SL8AXX	



UNIT:mm		
TOLERANCE		
±0.5mm		

TITLE M12 A Type Cable Female Conn.			
SCALE 3:2	SIZE A4	SHEET 2 OF 3	
REV. D	WC-REV. A.3	QC: Inspection item	

**Amphenol LTW**  
安費諾亮泰企業股份有限公司

ITEM NO	DRAWN BY Lingpeng	DATE 2017-04-06
DWG NO M12A-XXBFFM-SL8XXX	CHECKED BY Ma Fei	DATE 2017-04-06
CUSTOMER ALTW	APPROVED BY Jerry	DATE 2017-04-06

THIS DOCUMENT IS SUBJECT TO CHANGE WITHOUT NOTICE. IT IS CONFIDENTIAL AND A PROPERTY OF Amphenol LTW. DISCLOSURE TO THIRD PARTY HAS TO BE AUTHORIZED BY Amphenol LTW.

THIS DOCUMENT IS SUBJECT TO CHANGE WITHOUT NOTICE. IT IS CONFIDENTIAL AND A PROPERTY OF Amphenol LTW. DISCLOSURE TO THIRD PARTY HAS TO BE AUTHORIZED BY Amphenol LTW.

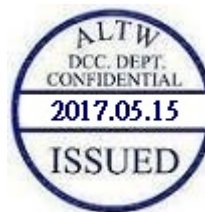
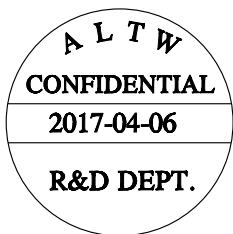

5	--		5	--		5	Gray	灰	5	Gray	灰	12	--		12	Red/Blue	紅/藍
4	Black	黑	4	Black	黑	4	Black	黑	4	Black	黑	11	--		11	Gray/Pink	灰/粉
3	Blue	藍	3	Blue	藍	3	Blue	藍	3	Blue	藍	10	Violet	紫	10	Violet	紫
2	--		2	White	白	2	White	白	2	White	白	9	Black	黑	9	Black	黑
1	Brown	棕	1	Brown	棕	1	Brown	棕	1	Brown	棕	8	Red	紅	8	Red	紅
												7	Blue	藍	7	Blue	藍
												6	Pink	粉	6	Pink	粉
												5	Gray	灰	5	Gray	灰
												4	Yellow	黃	4	Yellow	黃
												3	Green	綠	3	Green	綠
												2	Brown	棕	2	Brown	棕
												1	White	白	1	White	白

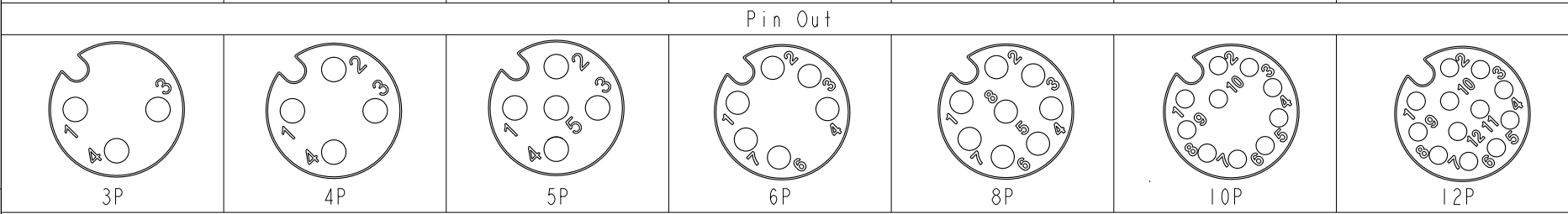

Pin Assignments Front View

UNIT:mm TOLERANCE ±0.5mm		TITLE M12 A Type Cable Female Conn.			<h2 style="text-align: center;">Amphenol LTW</h2> <p style="text-align: center;">安費諾亮泰企業股份有限公司</p>	ITEM NO	DRAWN BY	DATE
		SCALE 3:2	SIZE A4	SHEET 3 OF 3		DWG NO M12A-XXBFFM-SL8XXX	CHECKED BY Ma Fei	DATE 2017-04-06
		REV. D	WC-REV. A.2	QC: Inspection item		CUSTOMER ALTW	APPROVED BY Jerry	DATE 2017-04-06

# Mouser Electronics

Authorized Distributor

Click to View Pricing, Inventory, Delivery & Lifecycle Information:

## Amphenol:

[M12A-06BFFM-SR8D02](#) [M12A-03BFFM-SL8B03](#) [M12A-03BFFM-SL8D01](#) [M12A-04BFFM-SL8A01](#) [M12A-04BFFM-SL8B01](#) [M12A-04BFFM-SL8D01](#) [M12A-05BFFM-SL8A01](#) [M12A-05BFFM-SL8B01](#) [M12A-04BFFM-SL8D03](#) [M12A-04BFFM-SL8D05](#) [M12A-04BFFM-SL8D10](#) [M12A-08BFFM-SL8A03](#) [M12A-08BFFM-SL8B03](#) [M12A-08BFFM-SL8D10](#) [M12A-10BFFM-SL8D02](#) [M12A-04BFFM-SL8B05](#) [M12A-06BFFM-SL8A01](#) [M12A-06BFFM-SL8B01](#) [M12A-06BFFM-SL8D01](#) [M12A-08BFFM-SL8D05](#) [M12A-04BFFM-SL8D02](#) [M12A-03BFFM-SL8B05](#) [M12A-10BFFM-SL8D01](#) [M12A-12BFFM-SL8A01](#) [M12A-12BFFM-SL8B01](#) [M12A-12BFFM-SL8D01](#) [M12A-03BFFM-SL8B01](#) [M12A-03BFFM-SL8A01](#) [M12A-05BFFM-SL8D01](#) [M12A-08BFFM-SL8A01](#) [M12A-08BFFM-SL8B01](#) [M12A-08BFFM-SL8D01](#) [M12A-10BFFM-SL8A01](#) [M12A-10BFFM-SL8B01](#) [M12A-03BFFM-SR8B03](#) [M12A-03BFFM-SR8D02](#) [M12A-04BFFM-SR8B02](#) [M12A-03BFFM-SL8B30](#) [M12A-03BFFM-SL8B10](#) [M12A-08BFFM-SL8B02](#)