

Joystick Switch

Q-10527

TYPE: **CS-2011**

SPECIFICATIONS

Rating:	4A 600V AC
Position:	2
Action Type:	Self-locking
Material:	Plastic, Rubber, Metal
Contact Type:	SPST 2NO
Max. Isolation Voltage:	AC 600V
Delination Angle:	30 Degree
Fit for Mount Panel Thickness(Max.):	8mm/0.3"
Mount Panel Cutout Diameter:	29mm/1.1"
Lever Length:	7cm/ 2.8"
Operating Temperature:	-25°C ~ +100°C
Net Weight:	133g

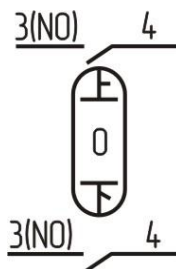
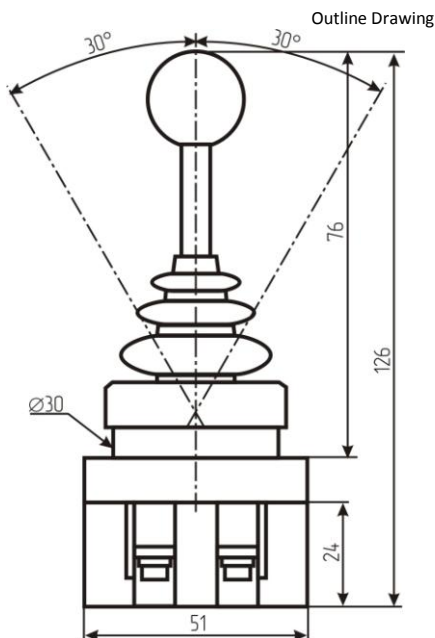

Сеть магазинов
КВАРЦ
 Радиодетали и электронные компоненты

107023, Москва, ул. Буженинова, д. 16
 телефон: (495) 963-6120
 факс: (495) 963-4994
 e-mail: quartz1@quartz1.ru

111123, Москва, шоссе Энтузиастов, д31
 телефон/факс: (495) 788-8899 многоканальный
 e-mail: mqz@quartz1.ru