

HVY-2314KPXA



MINITOP 2314 系列产品 / Products Series

具有高发光效率、高一致性、高稳定性、高可靠性，主要用于汽车应用

High luminous efficiency, consistency, stability and reliability, it is mainly used in automobile applications.

特征

- 外观：白色PPA塑料，硅树脂封装
- 50% I_v 视角：120°
- 颜色：黄色（583~595nm）
- 资格：可靠性测试符合AEC Q102
- 潮湿敏感等级-2

Features

- Package: Silicone in white PPA cup
- Viewing angle at 50% I_v : 120°
- Color: Yellow (583~595nm)
- Qualifications: Reliability test compliance with AEC Q102
- MSL-2

应用

- 信号灯
- 汽车内外部照明应用

Applications

- Signaling
- Interior and exterior lighting for automotive

订购信息 / Ordering Information

型号 Type	发光强度 Luminous Intensity I _v @ I _f = 20mA	订购编号 Ordering Code
HVY-2314KPXA - XXXX - XX - XXXX I I I 亮度档 颜色档 电压档 Brightness Color Forward Voltage	224 - 900mcd	XXXXXX

备注

■ 亮度档

单个最小包装只装有同一个亮度档次的产品，具体分档信息请见第4页

例如：HVY-2314KPXA-S2V1-XX-XXXX，单个卷盘中的产品只有S2、T1、T2、U1、U2、V1中的某一档

■ 颜色档

单个最小包装只装有同一个颜色档次的产品，具体分档信息请见第4页

例如：HVY-2314KPXA-XXXX-36-XXXX，单个卷盘中的产品只有3、4、5、6中的某一档

■ 正向电压档

单个最小包装只装有同一个正向电压档次的产品，具体分档信息请见第4页

例如：HVY-2314KPXA-XXXX-XX-3A4B，单个卷盘中的产品只有3A、3B、4A、4B中的某一档

Note

■ Brightness Grouping

Only one brightness group will be packed in one reel. Please refer to page #4 for details.

E. g. : HVY-2314KPXA-S2V1-XX-XXXX, means only one bin of S2、T1、T2、U1、U2 orV1 is in one reel.

■ Color Groups

Only one color group will be packed in one reel. Please refer to page #4 for details.

E. g. : HVY-2314KPXA-XXXX-36-XXXX, means only one bin of 3, 4, 5 or 6 is in one reel.

■ Forward Voltage Groups

Only one forward voltage group will be packed in one reel. Please refer to page #4 for details.

E. g. : HVY-2314KPXA-XXXX-XX-3A4B, means only one bin of 3A, 3B、4A or 4B is in one reel.

极限参数 / Maximum Ratings

参数 Parameters	符号 Symbol	数值 Rating	单位 Unit
结温 / Junction Temperature	T_j	125	°C
正向电流 / Forward Current ($T_s=25^\circ\text{C}$)	I_f	30	mA
峰值正向电流 Peak Forward Current ($t \leq 10\mu\text{s}$; $D=0.005$; $T_s=25^\circ\text{C}$)	I_{fp}	100	mA
反向电压 / Reverse Voltage ($T_s=25^\circ\text{C}$)	V_r	不适用于反向操作 Not designed for reverse operation	V
抗静电能力 Electrostatic Discharge (HBM)	V_{ESD}	2000	V
操作温度 / Operating Temperature	T_{opr}	-40 ~ + 100	°C
储存温度 / Storage Temperature	T_{stg}	-40 ~ + 100	°C

特性 / Characteristics ($T_s = 25^\circ\text{C}$; $I_f = 20\text{ mA}$)

参数 Parameters		符号 Symbol	数值 Rating	单位 Unit
峰值波长 / Wavelength at Peak Emission	typ.	λ_{peak}	593	nm
	min.	λ_{dom}	583	nm
主波长 / Dominant Wavelength	typ.	λ_{dom}	590	nm
	max.	λ_{dom}	595	nm
半波宽 / Spectral Bandwidth at 50% I_{rel} max	typ.	$\Delta\lambda$	18	nm
50 % I_v 下的视角 / Viewing Angle at 50 % I_v	typ.	2Φ	120	°
	min.	V_f	1.9	V
正向电压 / Forward Voltage	typ.	V_f	2.20	V
	max	V_f	2.50	V
	typ.	I_r	0.2	uA
反向电压 / Reverse Voltage (V_r) =5V	Max.	I_r	10	uA
	max.	$R_{th JS_{real}}$	330	°C/W
实际热阻值 (PN结-焊点) / Real Thermal Resistance (Junction / Solder Point)				

亮度分档 / Brightness Grouping ($T_s = 25\text{ }^\circ\text{C}$; $I_f = 20\text{ mA}$)

档次 Grouping	发光强度	发光强度	光通量
	Luminous Intensity I_v (min.)	Luminous Intensity I_v (max.)	Luminous Flux Φ_v (typ.)
S2	224 mcd	280mcd	
T1	280 mcd	355mcd	
T2	355 mcd	450 mcd	
U1	450 mcd	560 mcd	
U2	560 mcd	710 mcd	
V1	710 mcd	900 mcd	

正向电压分档 / Forward Voltage Grouping ($T_s = 25\text{ }^\circ\text{C}$; $I_f = 20\text{ mA}$)

档次 Grouping	正向电压	正向电压
	Forward Voltage V_f (min.)	Forward Voltage V_f (max.)
3A	1.90 V	2.05 V
3B	2.05 V	2.20 V
4A	2.20 V	2.35 V
4B	2.35 V	2.50 V

主波长分档 / Dominant Wavelength Grouping ($T_s = 25\text{ }^\circ\text{C}$; $I_f = 20\text{ mA}$)

档次 Grouping	主波长	主波长
	Dominant Wavelength λ_{dom} (min.)	Dominant Wavelength λ_{dom} (max.)
3	583 nm	586 nm
4	586 nm	589 nm
5	589 nm	592 nm
6	592 nm	595 nm

标签信息 / Information on Label

例 / E. g. : U1-3-4A

亮度档 / Brightness	颜色 / Color	正向电压 / Forward Voltage
U1	3	4A

相对发射光谱 - $V(\lambda)$ = 标准人眼视觉曲线

Relative Spectral Emission - $V(\lambda)$ = Standard Eye Response Curve

$I_{rel} = f(\lambda)$; $T_s = 25\text{ }^\circ\text{C}$; $I_f = 20\text{ mA}$

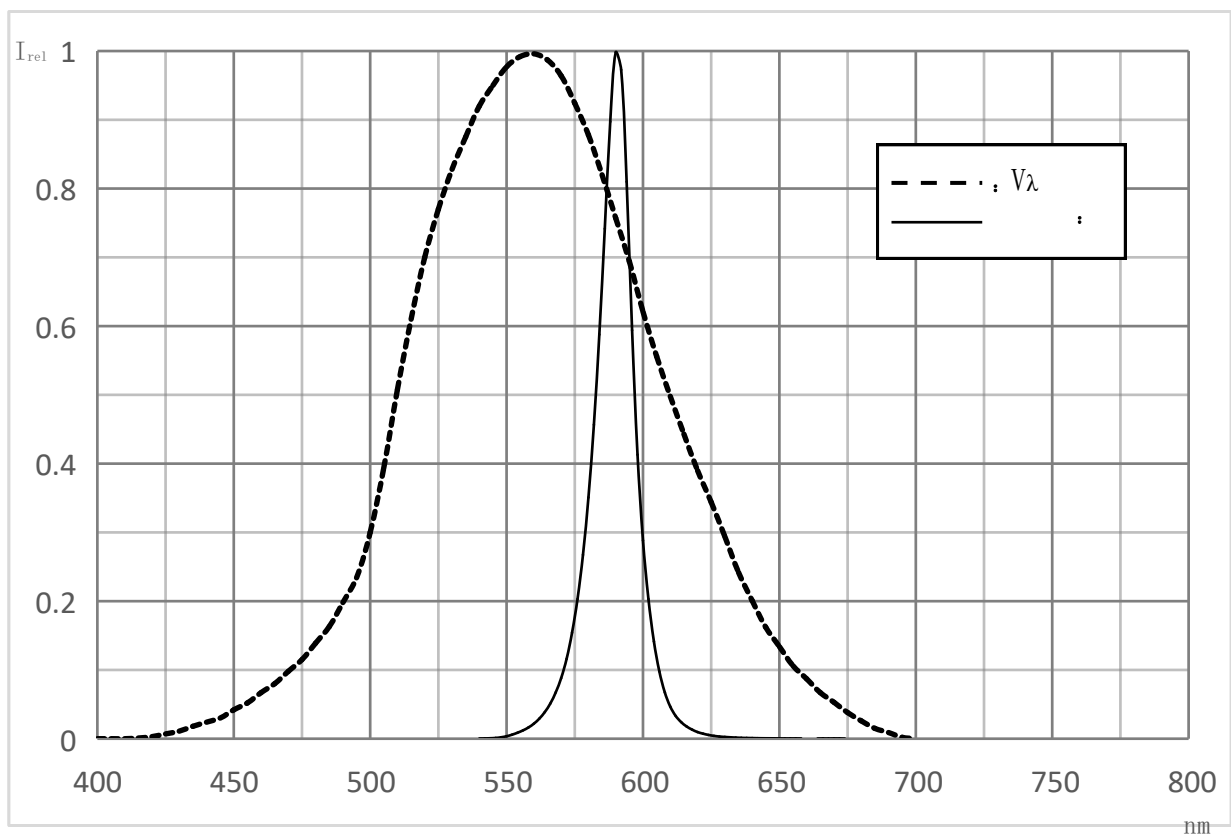

辐射特性 / Radiation Characteristics

$I_{rel} = f(\phi); T_s = 25\text{ }^\circ\text{C}$

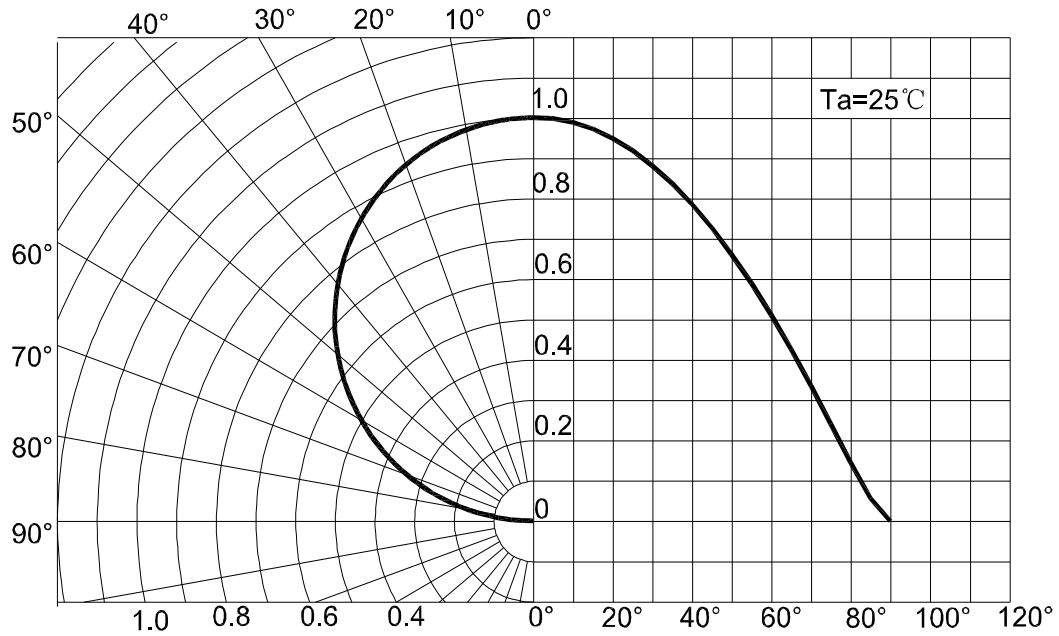

正向电流 / Forward Current

$I_f = f(V_f); T_a = 25\text{ }^\circ\text{C}$

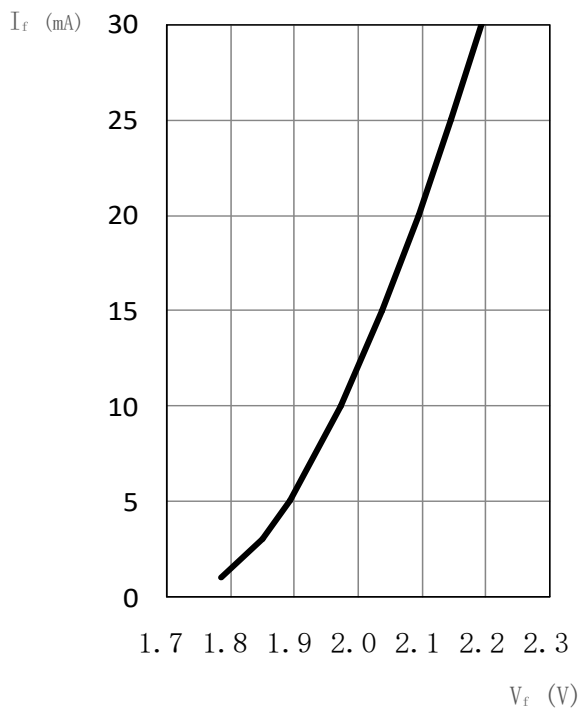

相对亮度特性曲线 / Relative Luminous Intensity

$I_v / I_v(20\text{ mA}) = f(I_f); T_a = 25\text{ }^\circ\text{C}$

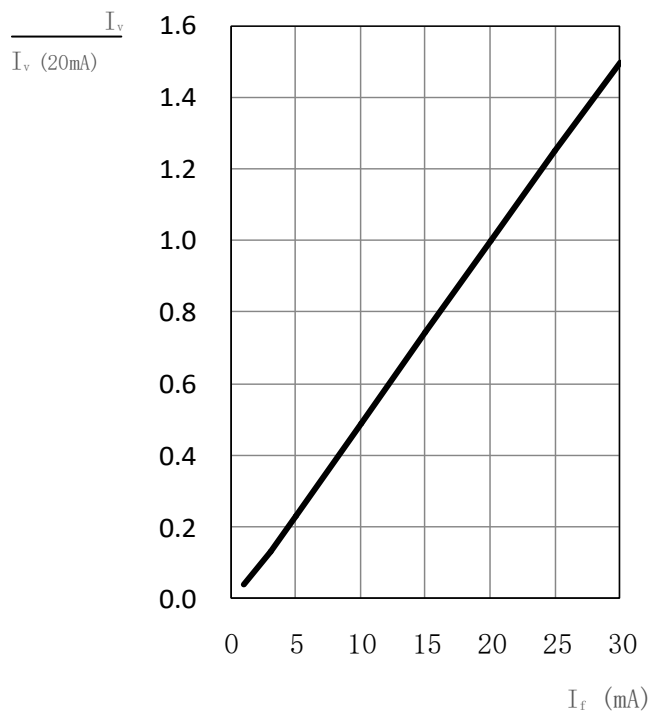

相对正向电压 / Relative Forward Voltage
 $\Delta V_f = V_f - V_f(25^\circ\text{C}) = f(T_j); I_f = 20\text{ mA}$

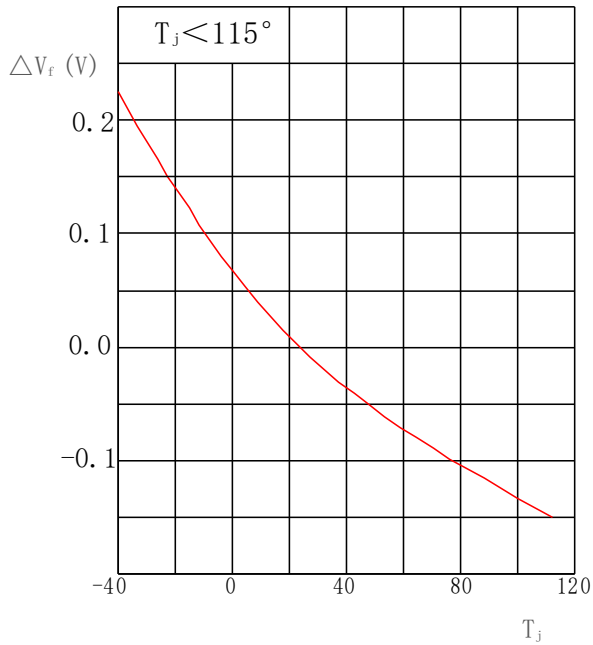

相对发光强度 / Relative Luminous Intensity
 $I_v / I_v(25^\circ\text{C}) = f(T_j); I_f = 20\text{ mA}$

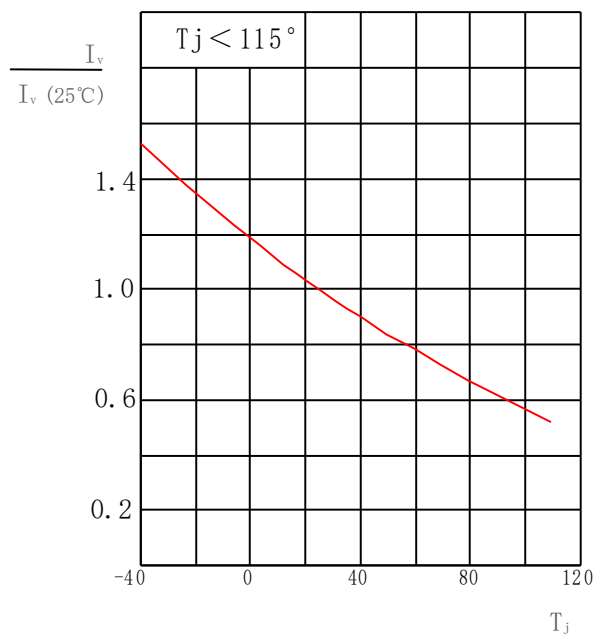

环境温度与正向电流
 Ambient Temperature vs. Forward Current
 $I_f = f(T_a)$

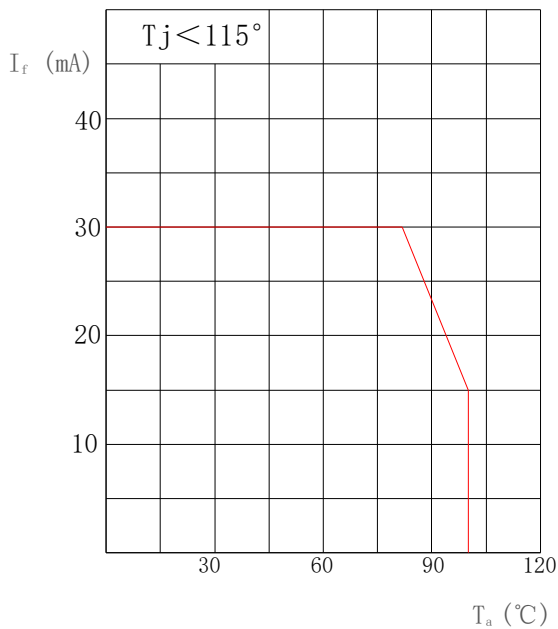

焊点温度与正向电流 / Solder Point Temperature vs. Forward Current
 $I_f = f(T_s)$

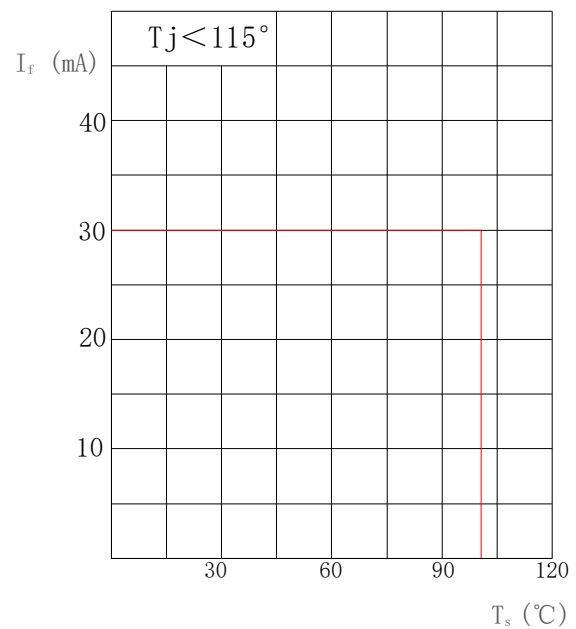

产品尺寸 / Package Outline

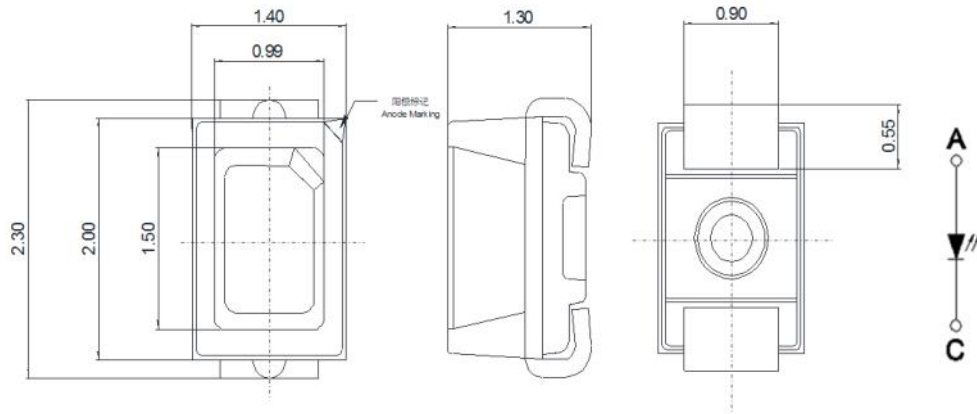

备注

- 统计质量: 10mg
- 标 记: 正极

NOTE

- Approximate Weight: 10mg
- Mark: Anode

推荐焊盘 / Recommended Solder Pad

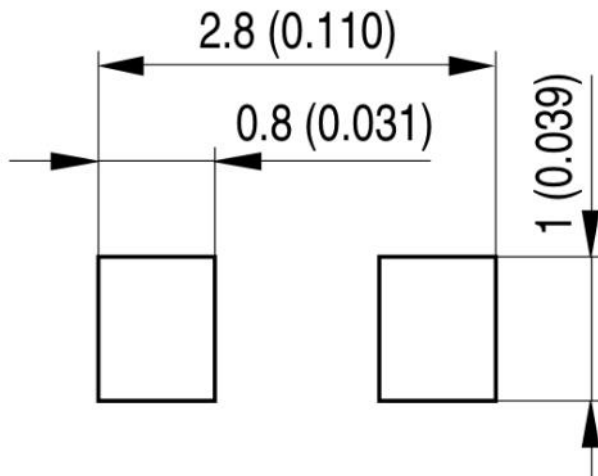

注释

- 不适合超声波清洗的封装

NOTE

- Package not suitable for ultrasonic cleaning

回流焊要求 / Reflow Soldering Profile

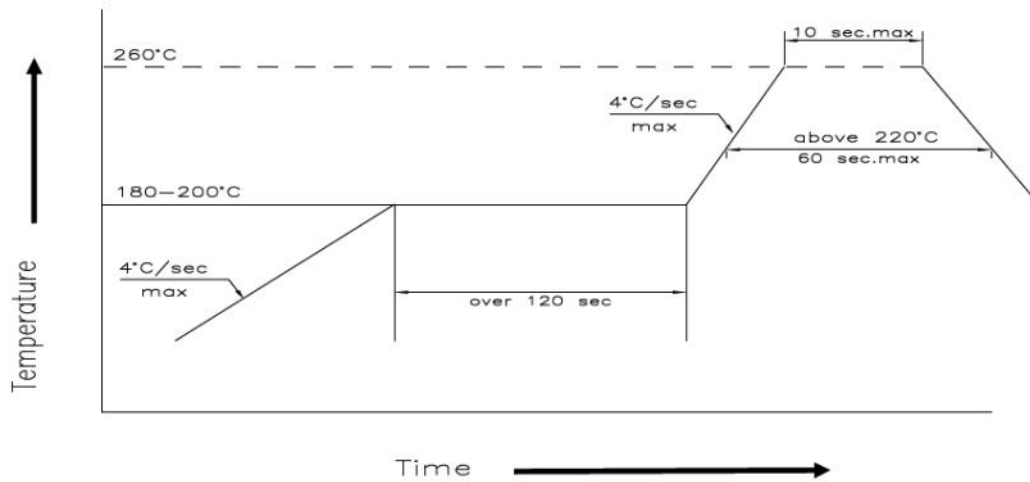

主要特性 Profile Feature	符号 Symbol	无铅焊接 Pb-Free Assembly			单位 Unit
		min.	rec.	max.	
预热升温速率 Ramp-up Rate to Preheat 25°C-150°C	-	-	2	3	°C/s
时间 / Time (T_{smin} to T_{smax})	T_s	60	100	120	s
峰值升温速率 Ramp-up Rate to Peak (T_{smax} to T_p)	-	-	2	3	°C/s
熔点温度 Liquidus Temperature	T_l		217		°C
高于熔点温度的时间 Time above Liquidus Temperature	t_l	-	80	100	s
峰值温度 / Peak Temperature	T_p	-	255	260	°C
规定的峰值温度±5°C以内的时间 Time within 5°C of the Specified Peak Temperature	t_p	10	20	30	s
降温速率 / Ramp-down Rate (T_p to 100°C)	-	-	3	6	°C/s
时间 / Time (25°C to T_p)	-	-	-	480	s

卷带与卷盘 / Tape and Reel

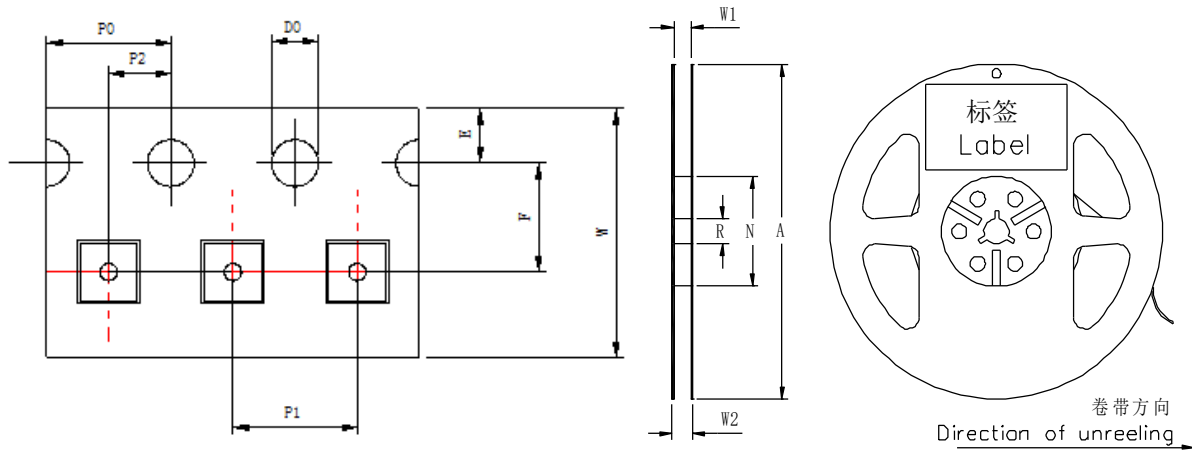

前端空带：最小400 mm；尾端空带： 最小160 mm；尺寸符合： IEC 60286-3, EIA 481-D标准
 Leader: min. 400 mm; Trailer: min. 160 mm; Requirement acc. to IEC 60286-3, EIA 481-D

卷带尺寸 / Tape Dimensions (mm)

W	P0	P1	P2	D0	E	F
8±0.1	4±0.1	4±0.1	2±0.05	1.5±0.05	1.75±0.1	3.5±0.05

卷盘尺寸 / Reel Dimensions (mm)

A	W1	W2	N	R
177.8	9.3±0.3	11.2±0.3	58.5±0.2	13.5±0.2

数量 (颗/卷) / Quantity (pcs/reel)

3000

条形码标签 / Barcode-Product-Label (BPL)



包装材料及过程 / Dry Packing Process and Materials

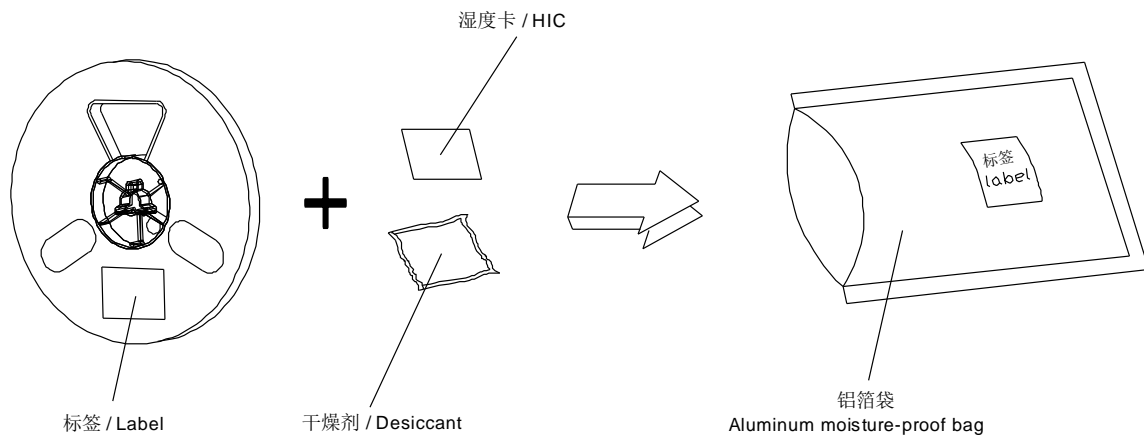

备注

产品包装在一个干燥的铝箔袋里，同时内附有干燥剂和湿度卡。
对于干燥包装，您可以从网络或JEDEC标准里获取。

NOTE

Moisture-sensitive product is packed in a dry bag containing desiccant and HIC (humidity indicator card).
Regarding dry pack you may find further information in the internet or JEDEC.

出货包装及材料 / Transportation Packing and Materials

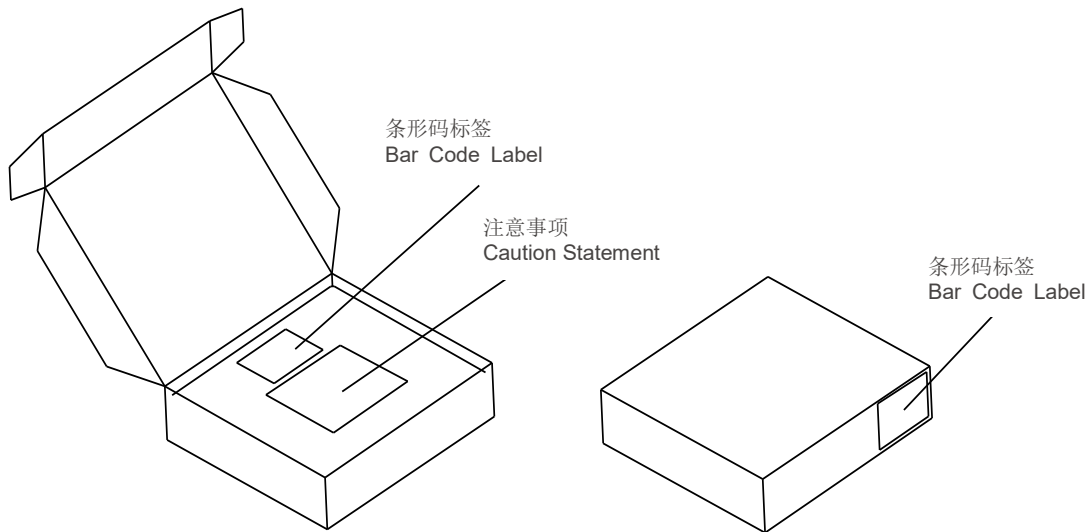

出货箱尺寸 / Dimensions of Transportation Box (mm)

宽度 / Width	长度 / Length	高度 / Height
256±5	223±5	62±5
256±5	223±5	124±5

注释

典型值： 每个产品的实际值可能与这些统计出的典型值不同。

公差： 除非图纸中有说明，公差默认为 ± 0.1 mm。

正向电压： 正向电压是在8ms脉冲电流并且内部再现性为 ± 0.05 V和一个 ± 0.1 V的外在不确定性（按照GUM K=3因子）来进行测试的。

波长： 波长是在25ms脉冲电流并且内部再现性为 ± 0.5 nm和一个 ± 1 nm的外在不确定性（按照GUM K=3因子）来进行测试的。

亮度： 亮度是在25ms脉冲电流并且内部再现性为 $\pm 8\%$ 和一个 $\pm 11\%$ 的外在不确定性（按照GUM K=3因子）来进行测试的。

特殊声明： 本版本最终解释权归属鸿利智汇，当中英文意思发生歧义时，以中文为准。

Glossary

Typical Values: Actual values of each product may differ from these statistical values .

Tolerance of Measure: Unless otherwise noted in drawing, tolerances are specified with +/-0.1mm.

Forward Voltage: The forward voltage is measured during a current pulse of typically 8 ms, with an internal reproducibility of ± 0.05 V and an expanded uncertainty of ± 0.1 V (acc. to GUM with a coverage factor of $k = 3$).

Wavelength: The wavelength is measured at a current pulse of typically 25 ms, with an internal reproducibility of ± 0.5 nm and an expanded uncertainty of ± 1 nm (acc. to GUM with a coverage factor of $k = 3$).

Brightness: Brightness values are measured during a current pulse of typically 25 ms, with an internal reproducibility of $\pm 8\%$ and an expanded uncertainty of $\pm 11\%$ (acc. to GUM with a coverage factor of $k = 3$).

Special Statement: The final interpretation of this specification shall be vested in Hongli-tronic, in the case of ambiguity, the Chinese version shall prevail.