

Mounting bracket
with strain
relief option

One-piece design,
non snap-open

Lightweight
and stable

Large pin for
high stability

Dirt-repellent
exterior

Double stop dog
for long un-
supported travels

+ Stable and cost-effective

When to use the Series 10 E2 mini:

- If an e-chain® with an inner height of 18 mm and small bending radii are required
- For inner widths up to 100 mm
- For unsupported lengths up to 1,2 m and fill weights up to 1,5 kg/m
- If a small but very stable e-chain® is required
- If a one-piece, non snap-open e-chain® is required
- If an interior separation is required



When to use a different igus® Series:

- If extremely quick opening of the links is necessary
- ▶ **Series 15 zipper**, page 4.38
- If quick insertion of cables with preassembled connectors is required
- ▶ **Series E14 easy chain®**, page 3.32



Series 10 with molded-in separator available.

More information ▶ **page 5.83**



Available from stock. Delivery in 24h or today!*

*Delivery time means time until shipping of goods



3D-CAD files, configurators, PDF ▶ www.igus.de/en/10

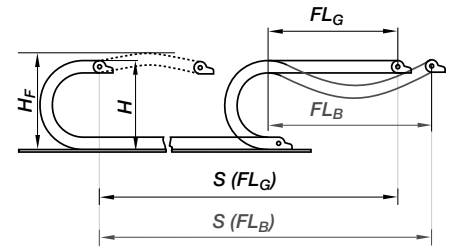
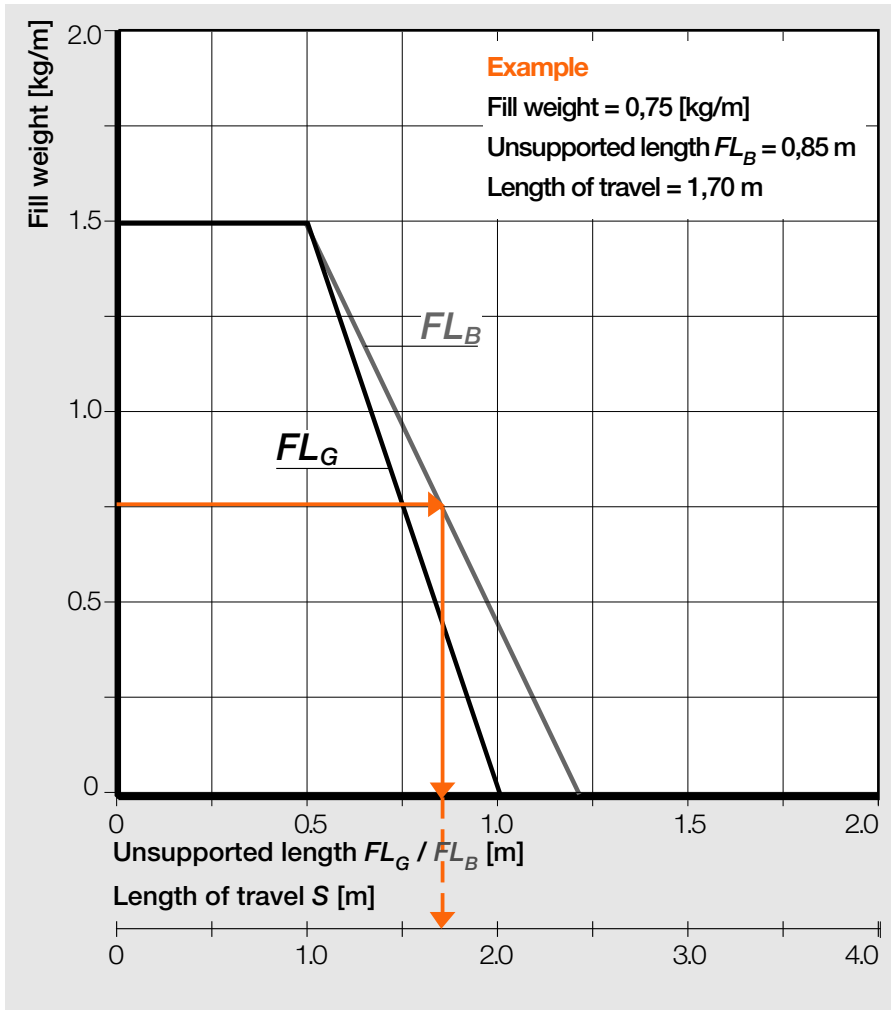

Standard **Unsupported applications**

Unsupported e-chains® feature positive camber over short travels. This must be accounted for when specifying the clearance height H_F . Please consult igus® if space is particularly restricted. More information ► **Design, page 1.8**

Technical Data

Speed, material, temperature and flammability class ► **page 5.78**

Pitch = 30,5 mm/link
Links/m = 33 (1006,5 mm)
Chain length = $S/2 + K$

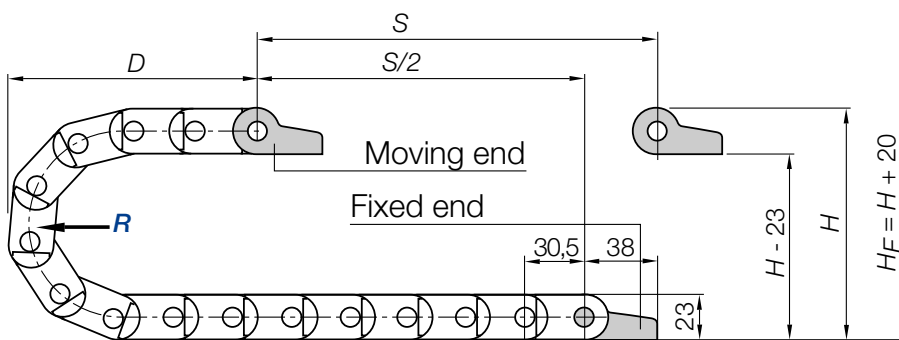

R	028	038	048	075	100	110	125	145	180
H	79	99	119	173	223	243	273	313	383
D	85	95	105	132	157	167	182	202	237
K	150	185	215	300	380	410	455	520	630

The required clearance height: $H_F = H + 20$ mm (with 0,5 kg/m fill weight)

- i** FL_G = with straight upper run **S** = Length of travel **H** = Nominal clearance height **D** = Overlength e-chain®, radius in final position
- FL_B = with permitted sag **R** = Bending radius H_F = Required clearance height **K** = $\pi \cdot R + \text{"safety"}$



Series 10 | One-piece, non snap-open e-chain®

non snap-open	<i>Bi</i> [mm]	<i>Ba</i> [mm]	<i>R</i> Bending radii [mm]	Weight [kg/m]
10. 015 . <i>R.0</i>	15	26	028 038 048 075 100 110 125 145 180	≈ 0,35
10. 025 . <i>R.0</i>	25	36	028 038 048 075 100 110 125 145 180	≈ 0,40
10. 038 . <i>R.0</i>	38	49	028 038 048 075 100 110 125 145 180	≈ 0,46
10. 050 . <i>R.0</i>	50	61	028 038 048 075 100 110 125 145 180	≈ 0,52
10. 5 . <i>R.0</i>	63	76	028 038 048 075 100 110 125 145 180	≈ 0,63
10. 6 . <i>R.0</i>	80	94	028 038 048 075 100 110 125 145 180	≈ 0,70
10. 7 . <i>R.0</i>	100	113	028 038 048 075 100 110 125 145 180	≈ 0,76

Supplement Part No. with required radius (*R*). Example: **10.025.038.0**

Order key 10. 025. 038. 0

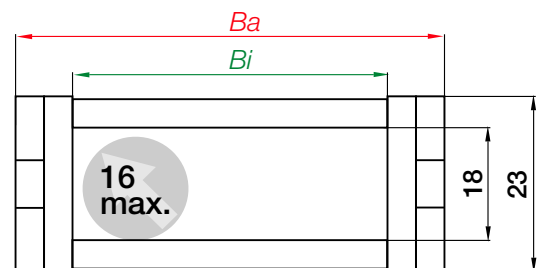
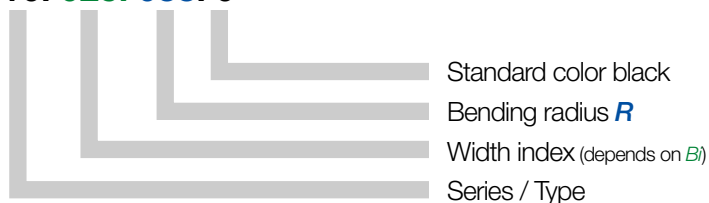

10.025.038.0 = non snap-open e-chain®, *Bi* 25 mm inner width, *R* 038 mm radius, color black
More order examples and configuration options ► page 5.87

Standard e-chains® available from stock. Delivery in 24h or today!*
*Delivery time means time until shipping of goods

E2 mini | Series 10 | Interior separation

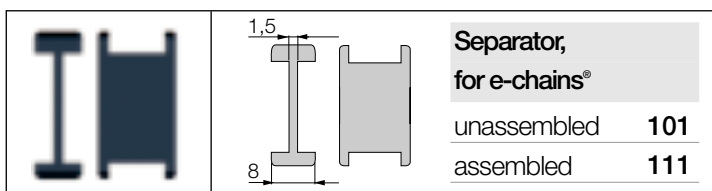
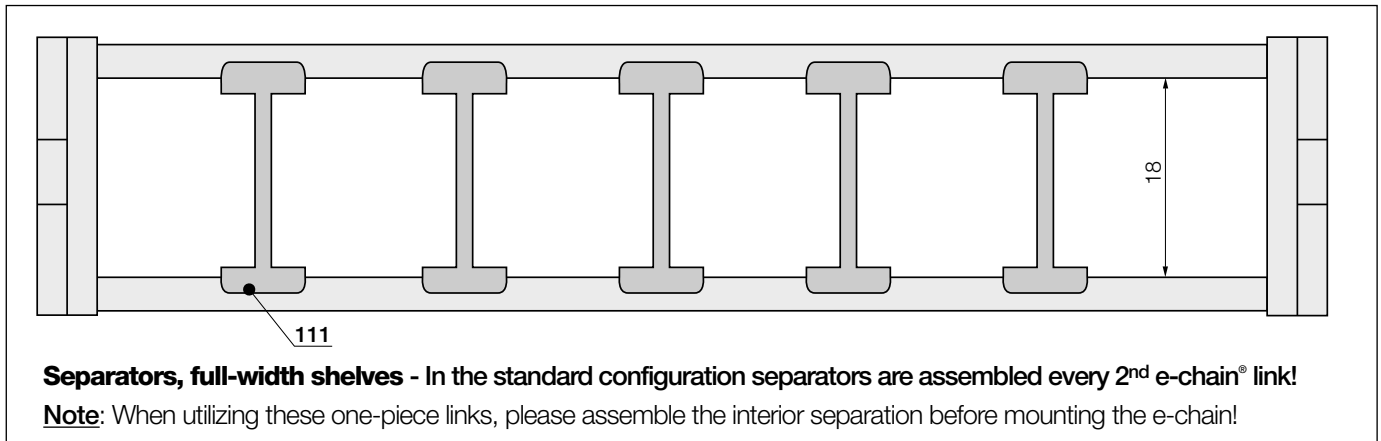

Separator 101

For a simple vertical subdivision on e-chains®. Separators can be arranged anywhere in the e-chain® cross-section.

Series 10 | Optional | With molded-in vertical separation

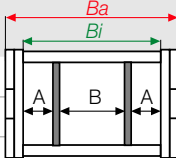
non snap-open	<i>Bi</i> [mm]	<i>Ba</i> [mm]	<i>R</i> Bending radii [mm]		Side compartment Dim. A [mm]	Middle compartment Dim. B [mm]	Weight [kg/m]
10.038.R.0.S	38	49	075		10	15	≈ 0,79
10.050.R.0.S	50	61	075		13	21	≈ 0,85

Supplement Part No. with required radius (*R*). Example: 10.038.075.0.S or 10.050.075.0.S

E2 mini | Series 10 | Mounting brackets pivoting

For tight installation conditions

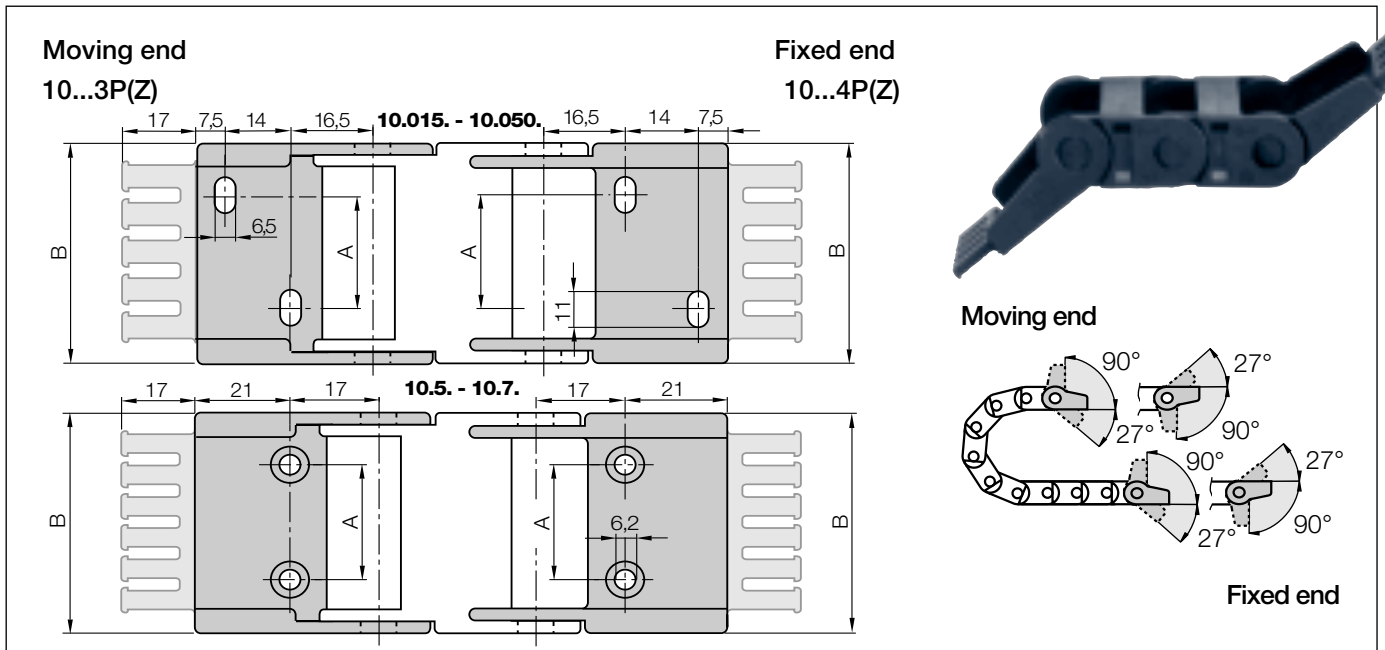

Polymer pivoting, one-piece | Standard

Recommended for unsupported and gliding applications

Width Index	Part No. full set with tiewrap plates	Part No. full set without tiewrap plates	Dim. A [mm]	Dim. B [mm]	Number of teeth
015.	▶ 1015.34PZ	1015.34P	–	25,5	2
025.	▶ 1025.34PZ	1025.34P	10	35,5	3
038.	▶ 1038.34PZ	1038.34P	23	48,5	4
050.	▶ 1050.34PZ	1050.34P	35	60,5	5
5.	▶ 105. 34PZ	105. 34P	48	75,0	6
6.	▶ 106. 34PZ	106. 34P	65	92,0	8
7.	▶ 107. 34PZ	107. 34P	85	112,0	10

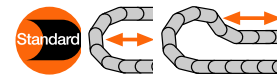

- Standard
- For tight installation conditions
- Strain relief with detachable tiewrap plates
- Variable traverse angle
- Corrosion-resistant
- Various installation options on the fixed end and/or the moving end

Part No. structure (pivoting)

1025. 34 PZ A1

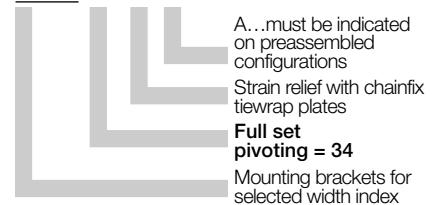

Single-part order

Mounting bracket **Moving end**

1025. 3 PZ A1 (preass. + tiewrap plate)

Mounting bracket **Fixed end**

1025. 4 PZ A1 (preass. + tiewrap plate)

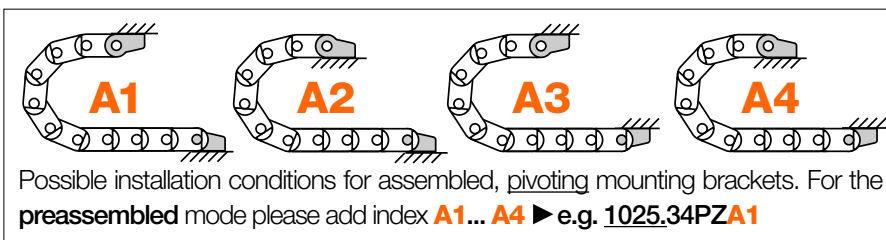

Strain relief e.g. clamps, tiewrap plates, nuggets and plug-in clips are available from stock. The complete chainfix range with order options ▶ from page 10.1

For very high speed and acceleration

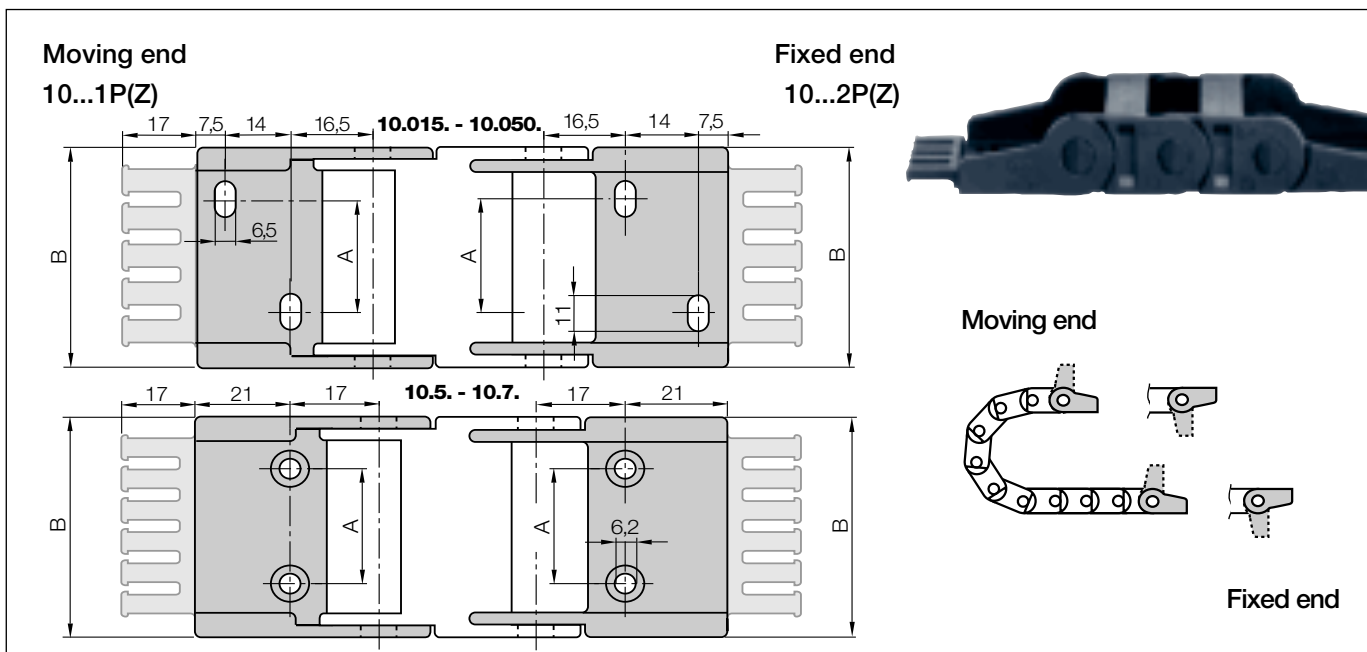

Polymer locking, one-piece

Recommended for vertical hanging and standing applications

Width Index	Part No. full set with tiewrap plates	Part No. full set without tiewrap plates	Dim. A [mm]	Dim. B [mm]	Number of teeth
015.	▶ 1015.12PZ	1015.12P	–	25,5	2
025.	▶ 1025.12PZ	1025.12P	10	35,5	3
038.	▶ 1038.12PZ	1038.12P	23	48,5	4
050.	▶ 1050.12PZ	1050.12P	35	60,5	5
5.	▶ 105. 12PZ	105. 12P	48	75,0	6
6.	▶ 106. 12PZ	106. 12P	65	92,0	8
7.	▶ 107. 12PZ	107. 12P	85	112,0	10

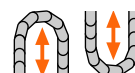

- Locked connections
- At very high speed and/or acceleration
- If space is limited for height (the H_F measurement)
- Various installation options on the fixed end and/or the moving end

Part No. structure (locking)

1025. 12 PZ **A1**



Single-part order

Mounting bracket **Moving end**

1025. 1 PZ A1 (preass. + tiewrap plate)

Mounting bracket **Fixed end**

1025. 2 PZ A1 (preass. + tiewrap plate)

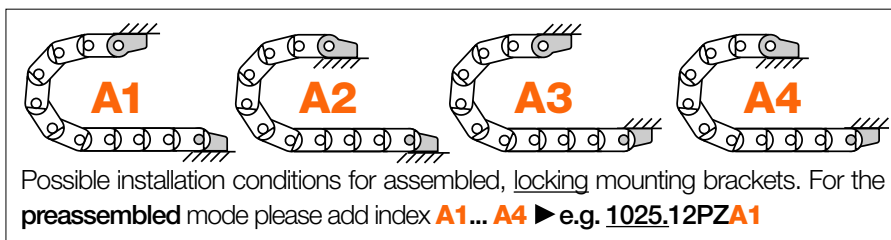

Strain relief e.g. clamps, tiewrap plates, nuggets and plug-in clips are available from stock. The complete chainfix range with order options ▶ from page 10.1

Aluminum "SuperTrough" | Basic Version

Installation set "Basic" with C-Profile

Bottom Clamp optionally attached inwards or outwards

10.025.038.0 ▶ Order example

B_{Ri} [mm]	Part No. attached inwards	Part No. attached outwards
.015	30	-
.025	40	-
.038	53	-
.050	65	960.30.125
.5	80	960.30.125
.6	98	960.30.150
.7	117	960.30.175

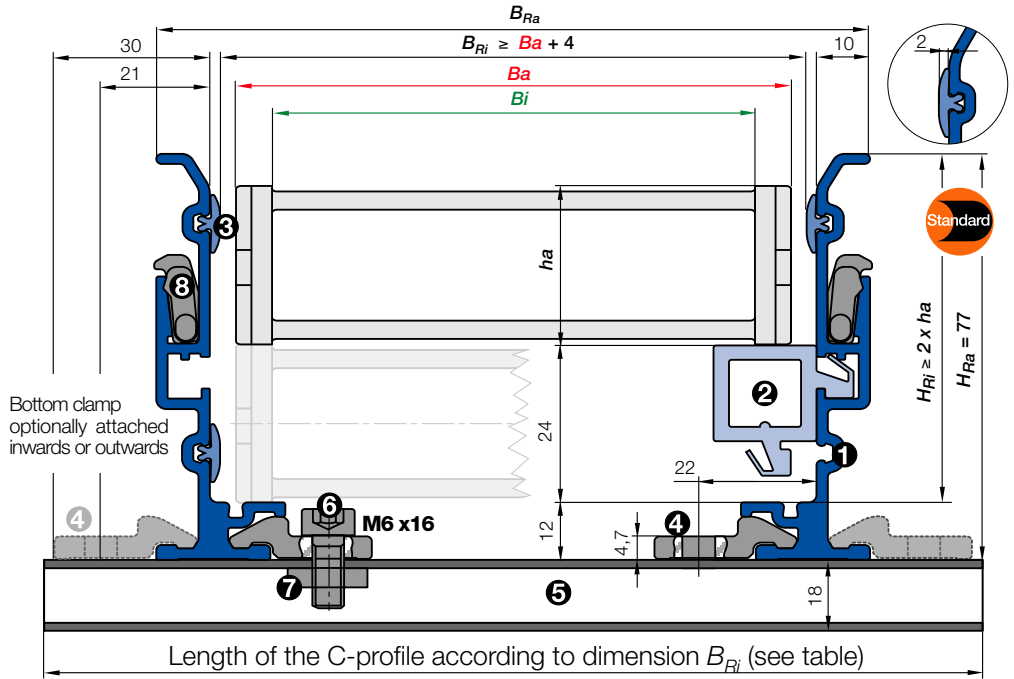

- **Components, trough "Basic":** ① Trough side parts, aluminum, 2 m ② Glide bar, plastic, 2 m ③ Glide strips, plastic, 2 m (without glide strips on request)
- **Components, installation set "Basic":** ④ Bottom clamp, aluminum ⑤ C-profile, galvanized steel ▶ table ⑥ Screw M6 x 16 ⑦ Sliding nut M6 ⑧ Interface connector, plastic



Order example: Length of travel 30 m - Center mounted for Series 10.5.038.0 with $B_{Ri} = 80$

Guide trough set **without glide bar** (set of 2 trough side parts, incl. glide strips)

Order text: 16 m guide trough without glide bar (8 x 2 m sections) **Part No. 970.30.SL**

Guide trough set **with glide bar** (set of 2 trough side parts, incl. glide strips)

Order text: 16 m guide trough with glide bar (8 x 2 m sections) **Part No. 970.31.SL**

Installation set "Basic" complete (guide trough-sets + 1)

Order text: 17 installation sets **Part No. 960.30.125**

Module for the fixed end ▶ page 9.16

Order text: 1 set **Part No. 970.80**

Option: For an additional noise dampening

with silencer profile, please add Index A - Example: Part No. 970.30.SLA









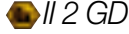

Principle sketch: Number of installation sets to be installed = Number of trough sections + 1

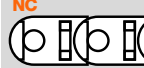

- Trough set
- Installation set
- Glide bar
- C-profile
- B_a = Outer width e-chains*
- B_i = Inner width e-chains*
- B_{Ri} = Inner trough width
- B_{Ra} = Outer trough width
- H_{Ri} = Inner trough height
- H_{Ra} = Outer trough height
- n_{Mon} = Number of installation sets
- n_{Ri} = Number of trough sets

E2 mini | Series 10 | Options and order key

 Standard	NC-Version - (no camber) without pretension	Reverse bending radius for circular movements	Unsupported lengths +25% possible	ATEX / ESD classified e-chains® 
Part No. Standard e-chains® 	Part No. NC-Material e-chains® 	Part No. RBR e-chains® 	Part No. XXL-Material* e-chains® 	Part No. ESD-Material e-chains® 
 10.025.R.0	10.025.R.0.NC	10.025.R1/R2.0	10.025.R.0.XXL	10.025.R.0.ESD
 Delivery time 24h or today!*	Delivery time 3-5 work days	Delivery time 10 work days	Delivery time 1-2 weeks	Delivery time 5 work days

(2-5 work days at an express surcharge)

Order example | Order key and color options

 **Order example for complete e-chain® (1,0 m), color black, with mounting brackets and interior separation:**

e-chain® (1,0 m)	Please indicate e-chain® length or number of links: 1,0 m or 33 links	10.025.038.0
+ Mounting brackets	1 set (+ tie-wrap plates)	1025.34PZ
+ Interior separation	with 2 separators assembled every 2 nd link	2 x 111

Order text: 1,0 m 10.025.038.0 + 1025.34PZ + 2 x 111















Order key **10.025.038.0**



Black e-chains® from stock!

*Colored e-chains® delivered in 15 work days (Delivery in 5 work days at an express surcharge, available upon request!)

Color options for e-chains® and e-tubes

Color	Order index	Color	Order index
 black	.0 from stock!	 green*	.7
 white*	.1	 grey*	.3 for e-chains®
 violet*	.5	 dusty grey*	.3 for e-tubes
 yellow*	.4	 agate grey*	.11
 orange*	.2	 light grey*	.14
 red*	.6	 black grey*	.13
 blue*	.8	 yellow/black*	.9

 **Available from stock. Delivery in 24h or today!***

*Delivery time means time until shipping of goods