

## 70V/8A Hyper Speed Control<sup>®</sup> Synchronous DC/DC Buck Regulator with External Soft Start

### Features

- Hyper Speed Control<sup>®</sup> Architecture Enables:
  - High input to output voltage conversion ratio capability ( $V_{IN} = 70V$  and  $V_{OUT} = 0.6V$ )
  - Small output capacitance
- 4.5V to 70V Input Voltage
- 8A Output Current Capability with Up to 95% Efficiency
- Adjustable Output Voltage from 0.6V to 32V
- $\pm 1\%$  FB Accuracy
- Any Capacitor<sup>™</sup> Stable:
  - Zero-ESR to high-ESR output capacitors
- 270 kHz to 800 kHz Adjustable Switching Frequency
- Internal Compensation
- Built-In 5V Regulator for Single-Supply Operation
- Auxiliary Bootstrap LDO for Improving System Efficiency
- Internal Bootstrap Diode
- Adjustable Soft Start Time
- Programmable Current Limit
- Hiccup Mode Short-Circuit Protection
- Thermal Shutdown
- Supports Safe Start-up Into a Pre-Biased Output
- Programmable Soft Start Time from 5 ms to 100 ms
- $-40^{\circ}C$  to  $+125^{\circ}C$  Junction Temperature Range
- Available in 32-Lead,  $6 \times 6$  mm VQFN Package
- AEC-Q104 Qualified (Parts with VAO Suffix)

### Applications

- Distributed Power Systems
- Communications/Networking Infrastructure
- Industrial Power Supplies
- Solar Energy

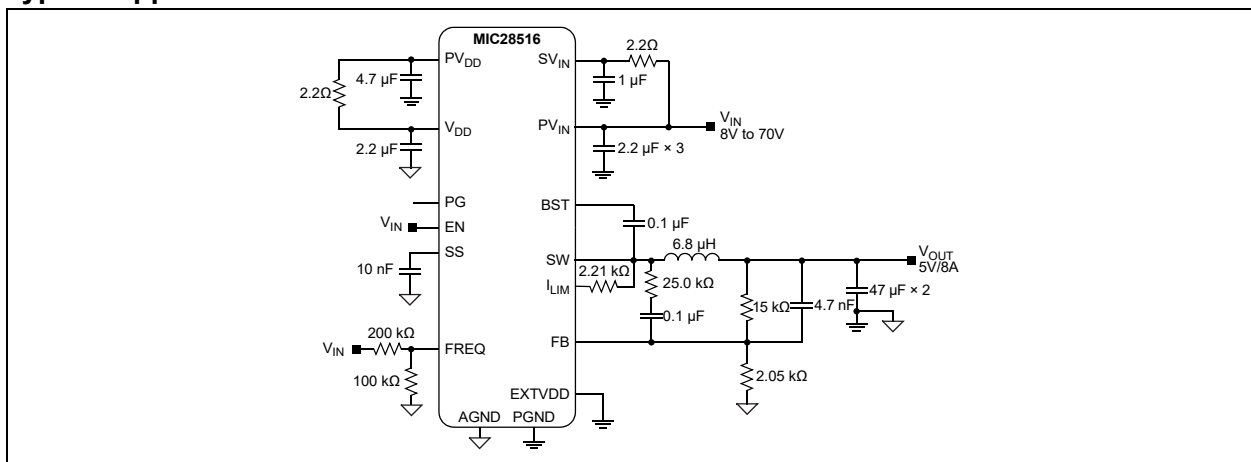
### General Description

The MIC28516 is an adjustable frequency, synchronous buck regulator that features a unique adaptive on-time control architecture. It operates over an input supply range of 4.5V to 70V and provides a regulated output current of up to 8A. The output voltage is adjustable down to 0.6V, with an accuracy of  $\pm 1\%$ .

The Hyper Speed Control architecture allows for an ultra-fast transient response, while reducing the output capacitance, and also makes high- $V_{IN}$ /low- $V_{OUT}$  operation possible. This adaptive on-time control architecture combines the advantages of fixed frequency operation and fast transient response in a single device.

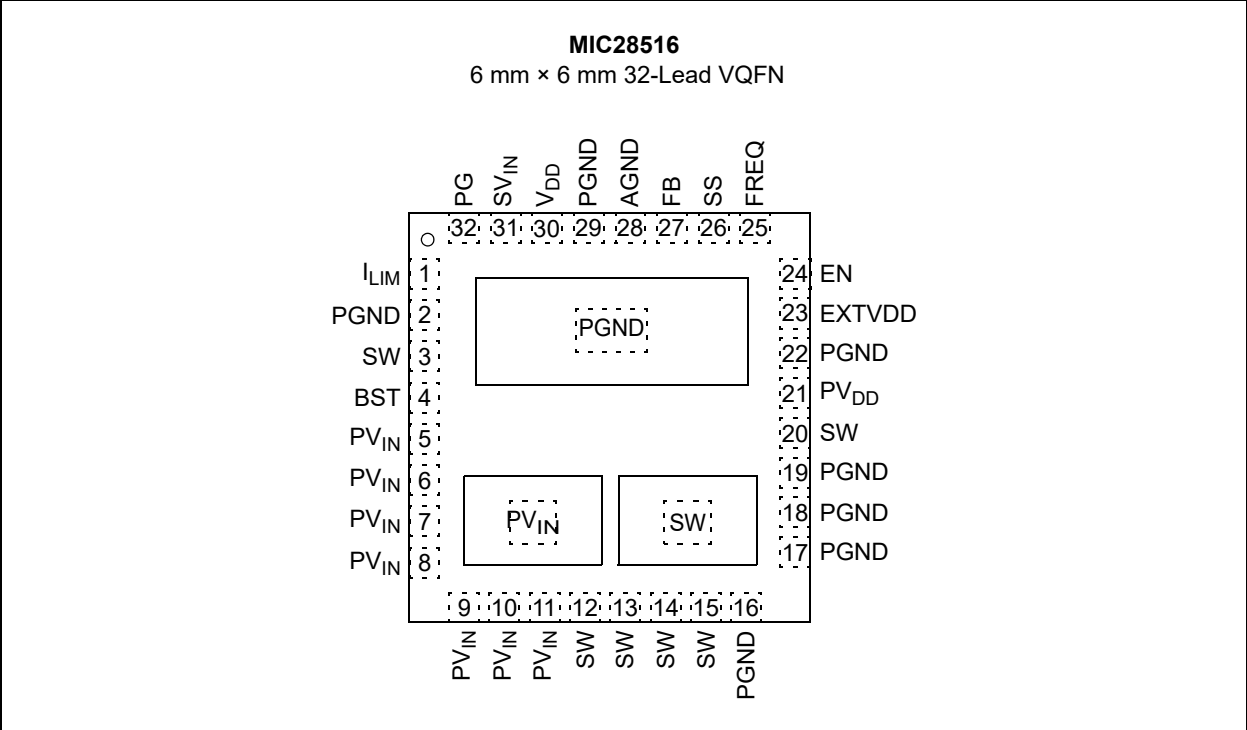
The MIC28516 offers a full suite of features that ensures the protection of the Integrated Circuit (IC) during Fault conditions. These features include Undervoltage Lockout (UVLO) to ensure proper operation under power sag conditions, soft start to reduce inrush current, Hiccup mode short-circuit protection and thermal shutdown.

### Typical Application Circuit

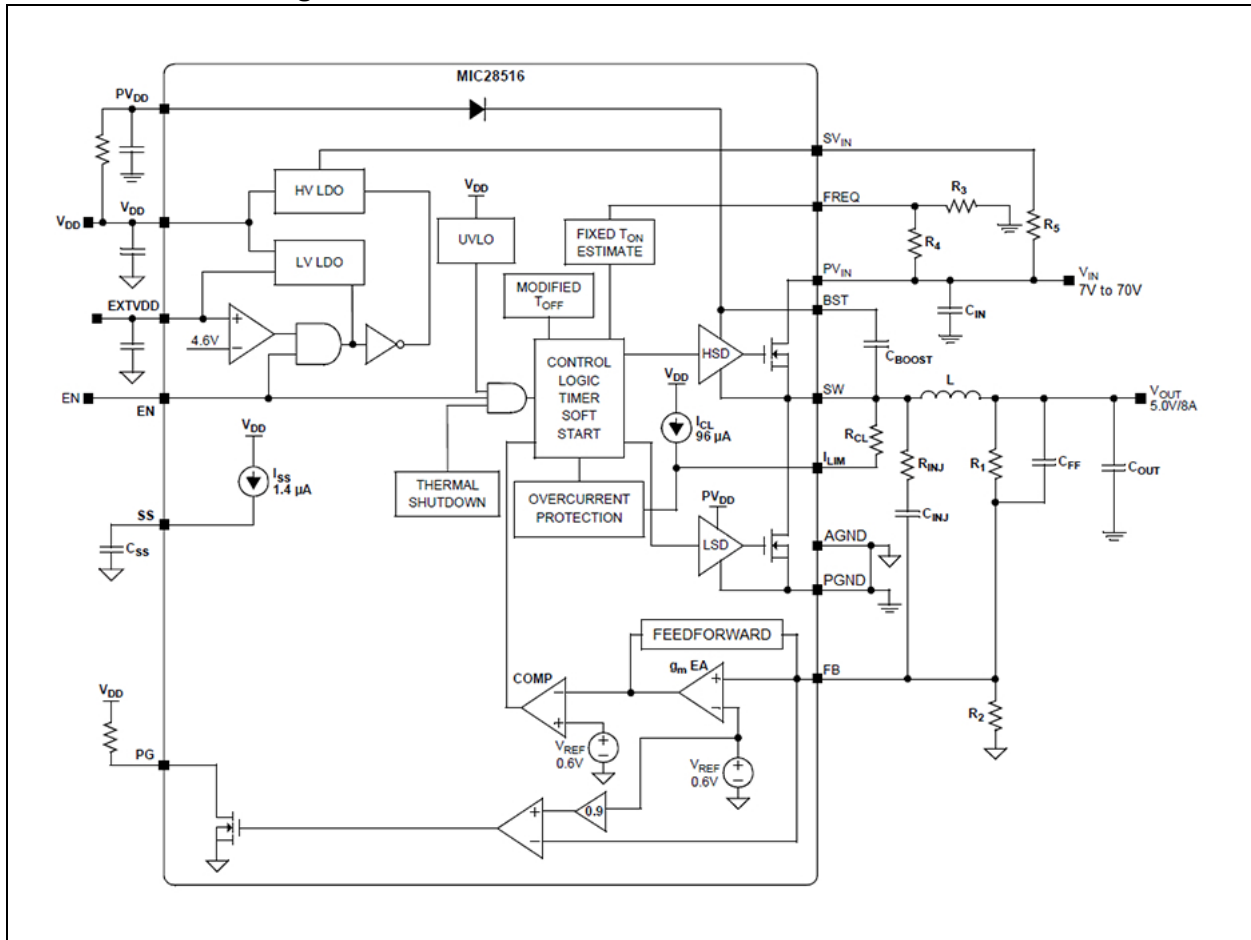


# MIC28516

## Package Type



## Functional Block Diagram



# MIC28516

## 1.0 ELECTRICAL CHARACTERISTICS

### Absolute Maximum Ratings†

PV <sub>IN</sub> , SV <sub>IN</sub> , FREQ to PGND	-0.3V to +71V
PV <sub>DD</sub> , V <sub>DD</sub> to PGND	-0.3V to +6V
SW, I <sub>LIM</sub> to PGND	-0.3V to (PV <sub>IN</sub> + 0.3V)
V <sub>BST</sub> to V <sub>SW</sub>	-0.3V to +6V
V <sub>BST</sub> to PGND	-0.3V to +76V
EN to AGND	-0.3V to (SV <sub>IN</sub> + 0.3V)
FB, PG to AGND	-0.3V to (V <sub>DD</sub> + 0.3V)
EXTVDD to AGND	-0.3V to +14V
PGND to AGND	-0.3V to +0.3V
Junction Temperature	+150°C
Storage Temperature	-65°C to +150°C
ESD Rating (Note 1)	ESD Sensitive

### Operating Ratings‡

Supply Voltage (SV <sub>IN</sub> , PV <sub>IN</sub> )	4.5V to 70V
Bias Voltage (PV <sub>DD</sub> , V <sub>DD</sub> )	4.5V to 5.5V
FB, PG	0V to V <sub>DD</sub>
EXTVDD	0V to 13.2V
Junction Temperature	-40°C to +125°C
EN	0V to PV <sub>IN</sub>

† **Notice:** Stresses above those listed under “Absolute Maximum Ratings” may cause permanent damage to the device. This is a stress rating only and functional operation of the device at those or any other conditions above those indicated in the operational sections of this specification is not intended. Exposure to maximum rating conditions for extended periods may affect device reliability.

‡ **Notice:** The device is not ensured to function outside its operating ratings.

**Note 1:** Devices are ESD-sensitive. Handling precautions are recommended. Human body model, 1.5 kΩ in series with 100 pF.

**TABLE 1-1: ELECTRICAL CHARACTERISTICS<sup>(1)</sup>**

**Electrical Characteristics:**  $PV_{IN} = 12V$ ,  $V_{OUT} = 5V$ ,  $V_{DD} = 5V$ ,  $V_{BST} - V_{SW} = 5V$ ,  $f_{SW} = 300\text{ kHz}$ ,  $R_{CL} = 2.21\text{ k}\Omega$ ,  $L = 6.8\text{ }\mu\text{H}$ ,  $T_A = +25^\circ\text{C}$ , unless noted. **Boldface** values indicate  $-40^\circ\text{C} \leq T_J \leq +125^\circ\text{C}$ . (**Note 3**)

Parameters	Symbol	Min.	Typ.	Max.	Units	Conditions
<b>Power Supply Input</b>						
Input Voltage Range	$PV_{IN}, SV_{IN}$	<b>4.5</b>	—	<b>70</b>	V	—
<b>V<sub>DD</sub> Bias Voltage</b>						
Operating Bias Voltage	$V_{DD}$	<b>4.8</b>	5.1	<b>5.4</b>	V	—
Undervoltage Lockout Trip Level	UVLO	<b>3.7</b>	4.2	<b>4.5</b>	V	$V_{DD}$ rising
UVLO Hysteresis	UVLO_HYS	—	600	—	mV	—
$V_{DD}$ Dropout Voltage	—	700	—	1250	mV	$V_{IN} = 5.5V$ , $I_{PVDD} = 25\text{ mA}$
EXTVDD Switchover Voltage	—	<b>4.4</b>	4.6	<b>4.8</b>	V	—
EXTVDD Switchover Hysteresis	—	—	0.2	—	V	—
Quiescent Supply Current	$I_Q$	—	1.25	—	mA	$V_{FB} = 1.5V$
Shutdown Supply Current	$I_{QSHDN}$	—	0.15	<b>2</b>	$\mu\text{A}$	Power from $V_{IN}$ , $V_{EN} = 0V$
		—	35	<b>60</b>	$\mu\text{A}$	$V_{IN} = V_{DD} = 5.5V$ , $V_{EN} = 0V$
<b>Reference</b>						
Feedback Reference Voltage	$V_{FB}$	0.597	0.6	0.603	V	$T_J = +25^\circ\text{C}$
		<b>0.594</b>	0.6	<b>0.606</b>		$-40^\circ\text{C} \leq T_J \leq +125^\circ\text{C}$
Load Regulation	—	—	0.04	—	%	$I_{OUT} = 0A$ to $8A$ ( <b>Note 4</b> )
Line Regulation	—	—	0.1	—	%	$PV_{IN} = 7V$ to $70V$ ( <b>Note 4</b> )
FB Bias Current	$I_{FB\_BIAS}$	—	0.05	<b>0.5</b>	$\mu\text{A}$	$V_{FB} = 0.6V$
<b>Enable Control</b>						
EN Logic Level High	$EN_{HIGH}$	<b>1.6</b>	—	—	V	—
EN Logic Level Low	$EN_{LOW}$	—	—	<b>0.6</b>	V	—
EN Bias Current	$I_{ENBIAS}$	—	6	<b>30</b>	$\mu\text{A}$	$V_{EN} = 0V$
<b>On Timer</b>						
Maximum Switching Frequency	FREQ	720	800	880	kHz	$FREQ = PV_{IN}$ , $I_{OUT} = 8A$
Minimum Switching Frequency	FREQ	<b>230</b>	270	<b>300</b>	kHz	$FREQ = 33\% PV_{IN}$
Maximum Duty Cycle	$D_{MAX}$	—	85	—	%	$V_{FB} = 0V$ , $FREQ = PV_{IN}$ ( <b>Note 1</b> )
Minimum Duty Cycle	$D_{MIN}$	—	0	—	%	$V_{FB} > 0.6V$
Minimum Off-Time	$t_{OFF(MIN)}$	100	200	<b>300</b>	ns	—
Minimum On-Time	$t_{ON(MIN)}$	—	60	—	ns	<b>Note 4</b>
<b>Soft Start</b>						
Soft Start Period Range	—	<b>2.5</b>	—	<b>40</b>	ms	—
<b>Current Limit</b>						
Current Limit	$I_{CLIM}$	9.2	10	10.8	A	$R_{CL} = 2.21\text{ k}\Omega$ ( <b>Note 2</b> , <b>Note 4</b> )
$I_{LIM}$ Source Current	$I_{CL}$	—	96	—	$\mu\text{A}$	—
$I_{LIM}$ Source Current Tempco	—	—	0.3	—	$\mu\text{A}/^\circ\text{C}$	<b>Note 4</b>

**Note 1:** Specification is for packaged product only.

**2:** The  $I_{CL}$  is trimmed to get the current in the limits at room temperature.

**3:** Temperature limits apply for automotive AEC-Q104 qualified part.

**4:** Not production tested. Specification obtained by characterization.

# MIC28516

**TABLE 1-1: ELECTRICAL CHARACTERISTICS<sup>(1)</sup> (CONTINUED)**

**Electrical Characteristics:**  $PV_{IN} = 12V$ ,  $V_{OUT} = 5V$ ,  $V_{DD} = 5V$ ,  $V_{BST} - V_{SW} = 5V$ ,  $f_{SW} = 300\text{ kHz}$ ,  $R_{CL} = 2.21\text{ k}\Omega$ ,  $L = 6.8\text{ }\mu\text{H}$ ,  $T_A = +25^\circ\text{C}$ , unless noted. **Boldface** values indicate  $-40^\circ\text{C} \leq T_J \leq +125^\circ\text{C}$ . (**Note 3**)

Parameters	Symbol	Min.	Typ.	Max.	Units	Conditions
<b>Internal FETs</b>						
Top MOSFET $R_{DS(ON)}$	$R_{DS(ON)}$	—	18	—	m $\Omega$	—
Bottom MOSFET $R_{DS(ON)}$	$R_{DS(ON)}$	—	18	—	m $\Omega$	—
SW Leakage Current	$I_{SWLEAK}$	—	—	<b>5</b>	$\mu\text{A}$	$PV_{IN} = 48V$ , $V_{EN} = 0V$
$PV_{IN}$ Leakage Current	$I_{VINLEAK}$	—	—	<b>10</b>	$\mu\text{A}$	$PV_{IN} = 48V$ , $V_{EN} = 0V$
BST Leakage Current	$I_{BSTLEAK}$	—	—	<b>10</b>	$\mu\text{A}$	$PV_{IN} = 48V$ , $V_{EN} = 0V$
<b>Power Good (PG)</b>						
PG Threshold	$V_{PG\_TH}$	<b>85</b>	90	<b>95</b>	%	$V_{FB}$ rising
PG Threshold Hysteresis	$V_{PG\_HYS}$	—	6	—	%	$V_{FB}$ falling
PG Delay Time	$t_{PG\_DLY}$	—	100	—	$\mu\text{s}$	$V_{FB}$ rising
PG Low Voltage	$V_{PG\_LOW}$	—	70	<b>200</b>	mV	$V_{FB} < 90\% \times V_{NOM}$ , $I_{PG} = 1\text{ mA}$
<b>Thermal Protection</b>						
Overtemperature Shutdown	$T_{SHD}$	—	+150	—	$^\circ\text{C}$	$T_J$ rising ( <b>Note 4</b> )
Overtemperature Shutdown Hysteresis	$T_{SHD\_HYS}$	—	+15	—	$^\circ\text{C}$	<b>Note 4</b>

**Note 1:** Specification is for packaged product only.

**2:** The  $I_{CL}$  is trimmed to get the current in the limits at room temperature.

**3:** Temperature limits apply for automotive AEC-Q104 qualified part.

**4:** Not production tested. Specification obtained by characterization.

**TABLE 1-2: TEMPERATURE SPECIFICATIONS**

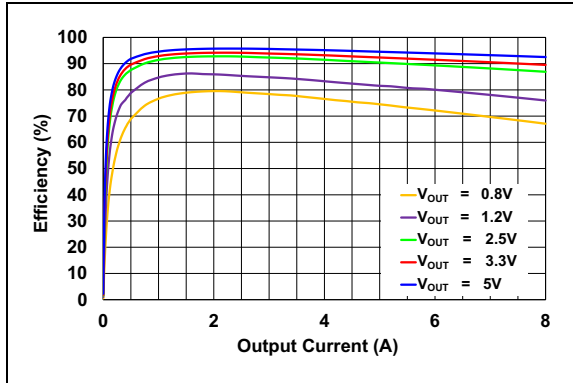
Parameters	Sym.	Min.	Typ.	Max.	Units	Conditions
<b>Temperature Ranges</b>						
Junction Operating Temperature	$T_J$	-40	—	+125	$^\circ\text{C}$	<b>Note 1</b>
Storage Temperature Range	$T_S$	-65	—	+150	$^\circ\text{C}$	—
Maximum Junction Temperature	$T_{J(ABSMAX)}$	—	—	+150	$^\circ\text{C}$	—
Lead Temperature	$T_{LEAD}$	—	—	+260	$^\circ\text{C}$	Soldering, 10s
<b>Package Thermal Resistance</b>						
Thermal Resistance, 6 mm $\times$ 6 mm, 32-Lead QFN	$\theta_{JA}$	—	33.3	—	$^\circ\text{C/W}$	—

**Note 1:** The maximum allowable power dissipation is a function of ambient temperature, the maximum allowable junction temperature and the thermal resistance from junction to air (i.e.,  $T_A$ ,  $T_J$ ,  $\theta_{JA}$ ). Exceeding the maximum allowable power dissipation will cause the device operating junction temperature to exceed the maximum  $+125^\circ\text{C}$  rating. Sustained junction temperatures above  $+125^\circ\text{C}$  can impact the device reliability.

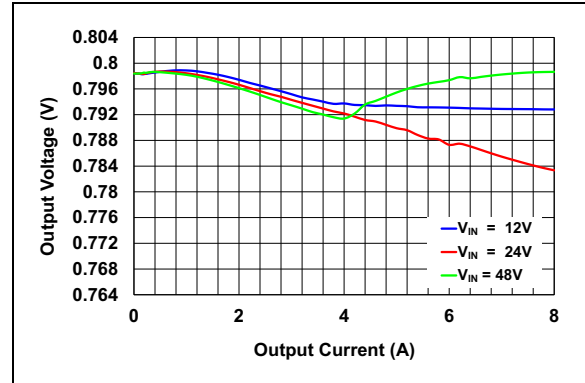
## 2.0 TYPICAL PERFORMANCE CURVES

**Note:** The graphs and tables provided following this note are a statistical summary based on a limited number of samples and are provided for informational purposes only. The performance characteristics listed herein are not tested or ensured. In some graphs or tables, the data presented may be outside the specified operating range (e.g., outside specified power supply range) and therefore, outside the warranted range.

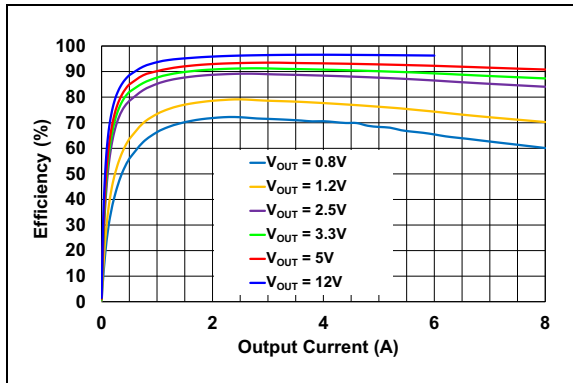
**Note:** Unless otherwise indicated,  $V_{IN} = 12V$ ,  $V_{OUT} = 5V$ ,  $I_{OUT} = 0A$ ,  $f_{SW} = 300\text{ kHz}$ ,  $R_{CL} = 2.21\text{ k}\Omega$ ,  $L = 6.8\text{ }\mu\text{H}$ .



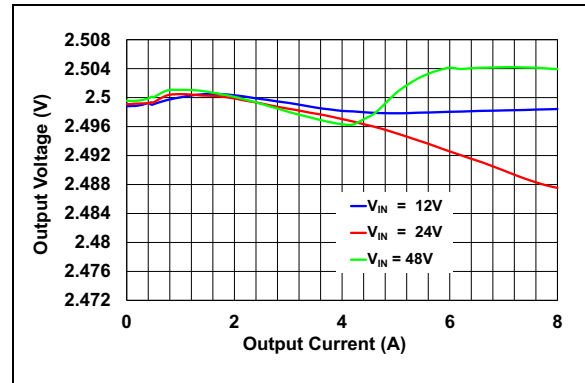
**FIGURE 2-1:** Efficiency vs. Output Current ( $V_{IN} = 12V$ ).



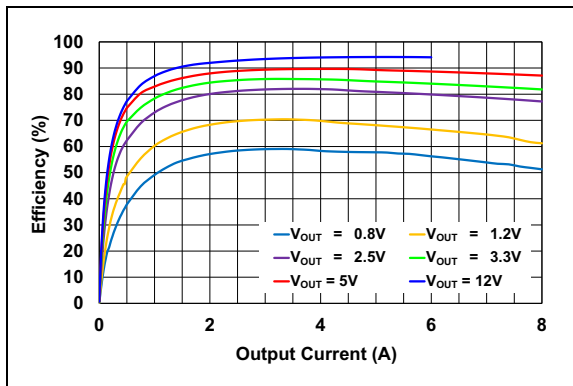
**FIGURE 2-4:** Output Voltage vs. Output Current ( $V_{OUT} = 0.8V$ ).



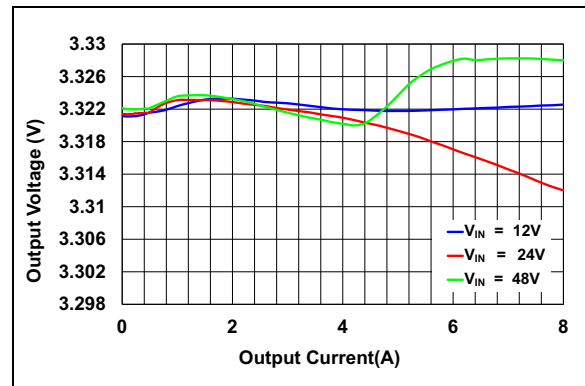
**FIGURE 2-2:** Efficiency vs. Output Current ( $V_{IN} = 24V$ ).



**FIGURE 2-5:** Output Voltage vs. Output Current ( $V_{OUT} = 2.5V$ ).



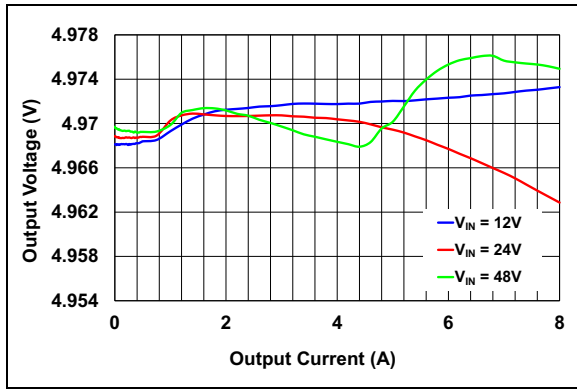
**FIGURE 2-3:** Efficiency vs. Output Current ( $V_{IN} = 48V$ ).



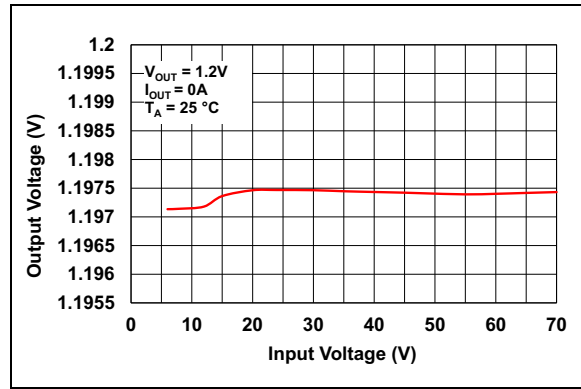
**FIGURE 2-6:** Output Voltage vs. Output Current ( $V_{OUT} = 3.3V$ ).

# MIC28516

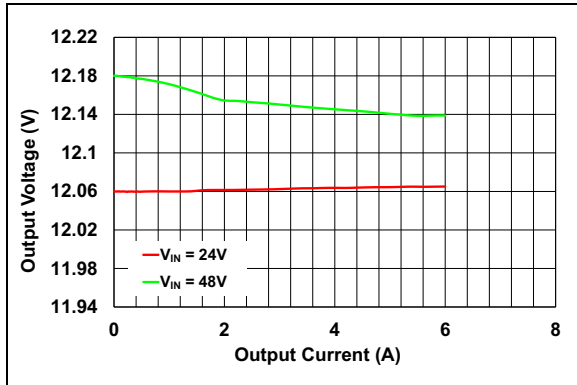
Note: Unless otherwise indicated,  $V_{IN} = 12V$ ,  $V_{OUT} = 5V$ ,  $I_{OUT} = 0A$ ,  $f_{SW} = 300\text{ kHz}$ ,  $R_{CL} = 2.21\text{ k}\Omega$ ,  $L = 6.8\text{ }\mu\text{H}$ .



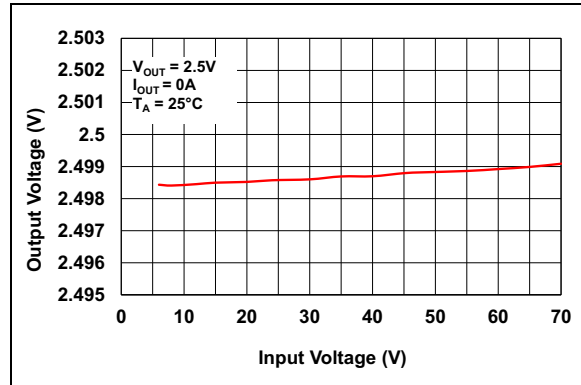
**FIGURE 2-7:** Output Voltage vs. Output Current ( $V_{OUT} = 5V$ ).



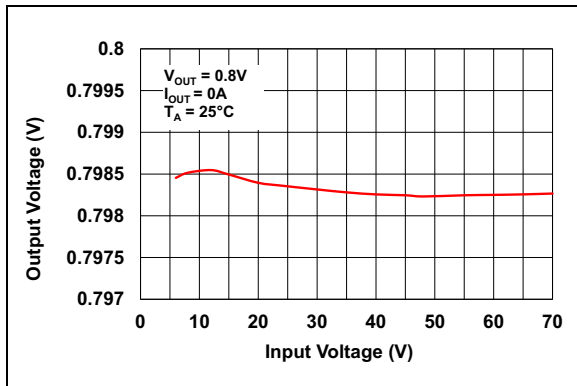
**FIGURE 2-10:** Output Voltage vs. Input Voltage ( $V_{OUT} = 1.2V$ ).



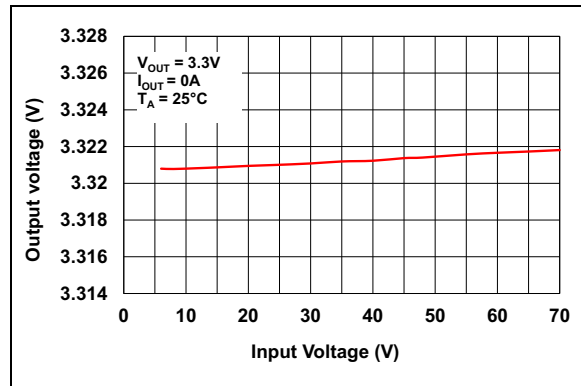
**FIGURE 2-8:** Output Voltage vs. Output Current ( $V_{OUT} = 12V$ ).



**FIGURE 2-11:** Output Voltage vs. Input Voltage ( $V_{OUT} = 2.5V$ ).



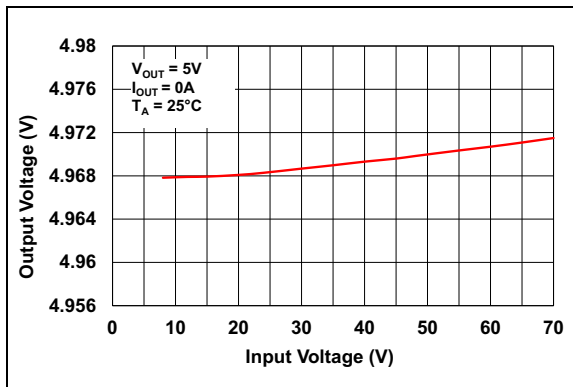
**FIGURE 2-9:** Output Voltage vs. Input Voltage ( $V_{OUT} = 0.8V$ ).



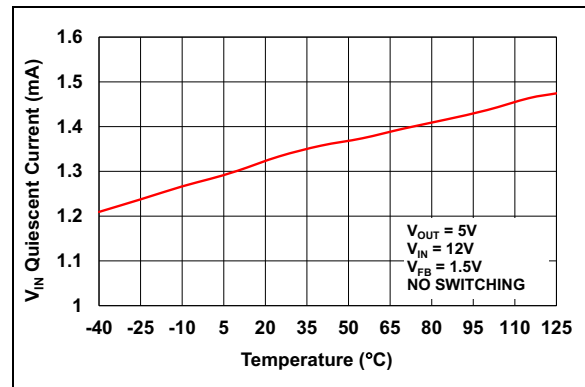
**FIGURE 2-12:** Output Voltage vs. Input Voltage ( $V_{OUT} = 3.3V$ ).



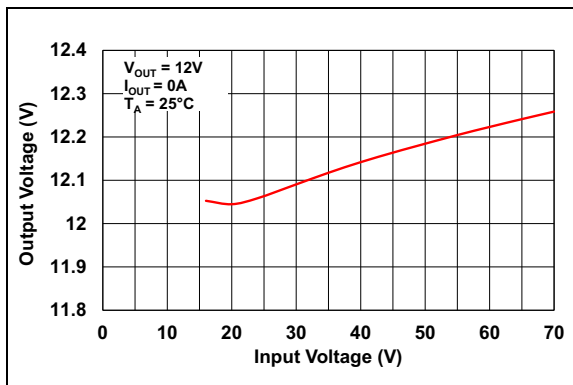
**Note:** Unless otherwise indicated,  $V_{IN} = 12V$ ,  $V_{OUT} = 5V$ ,  $I_{OUT} = 0A$ ,  $f_{SW} = 300\text{ kHz}$ ,  $R_{CL} = 2.21\text{ k}\Omega$ ,  $L = 6.8\text{ }\mu\text{H}$ .



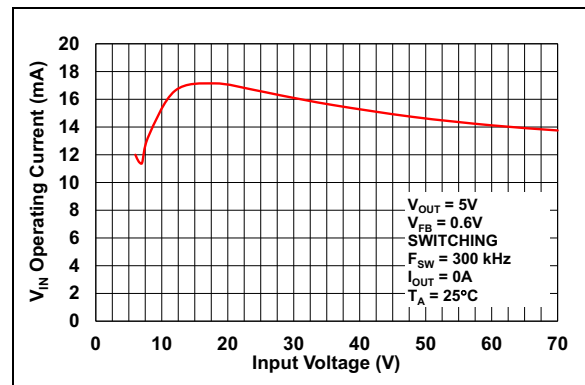
**FIGURE 2-13:** Output Voltage vs. Input Voltage ( $V_{OUT} = 5V$ ).



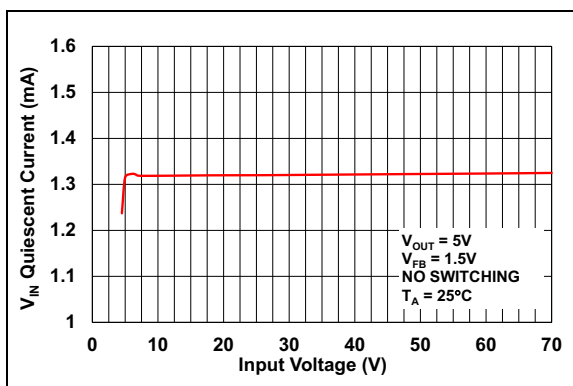
**FIGURE 2-16:**  $V_{IN}$  Quiescent Current vs. Temperature.



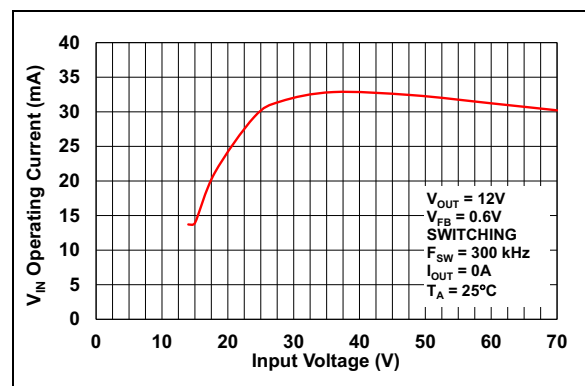
**FIGURE 2-14:** Output Voltage vs. Input Voltage ( $V_{OUT} = 12V$ ).



**FIGURE 2-17:**  $V_{IN}$  Operating Current vs. Input Voltage ( $V_{OUT} = 5V$ ).



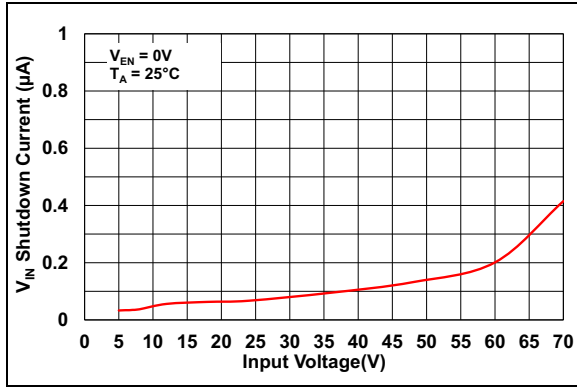
**FIGURE 2-15:**  $V_{IN}$  Quiescent Current vs. Input Voltage.



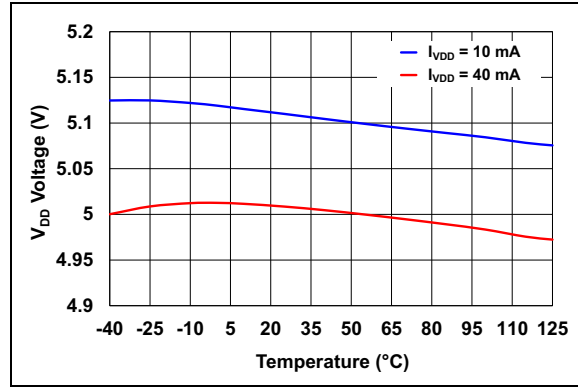
**FIGURE 2-18:**  $V_{IN}$  Operating Current vs. Input Voltage ( $V_{OUT} = 12V$ ).

# MIC28516

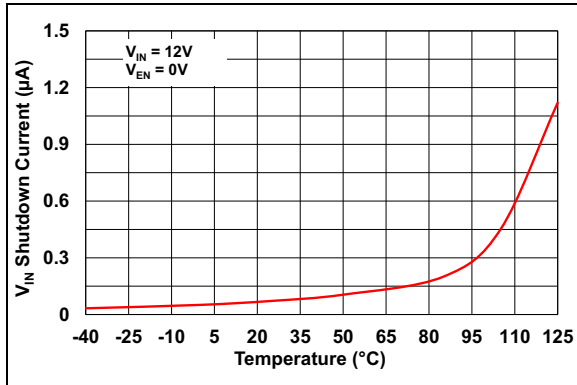
Note: Unless otherwise indicated,  $V_{IN} = 12V$ ,  $V_{OUT} = 5V$ ,  $I_{OUT} = 0A$ ,  $f_{SW} = 300\text{ kHz}$ ,  $R_{CL} = 2.21\text{ k}\Omega$ ,  $L = 6.8\text{ }\mu\text{H}$ .



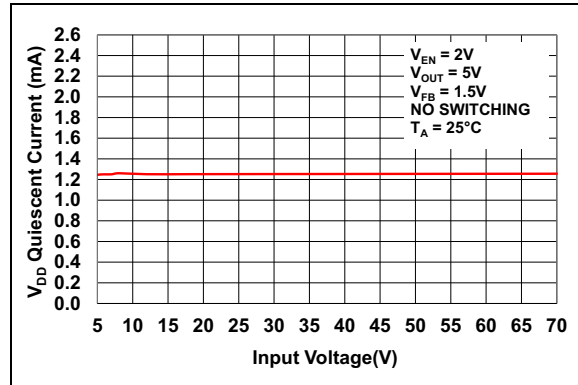
**FIGURE 2-19:**  $V_{IN}$  Shutdown Current vs. Input Voltage.



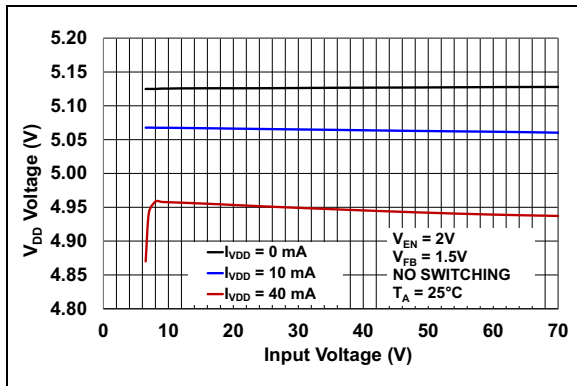
**FIGURE 2-22:**  $V_{DD}$  Voltage vs. Temperature.



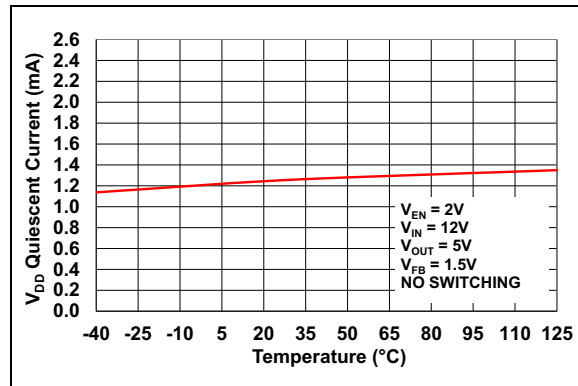
**FIGURE 2-20:**  $V_{IN}$  Shutdown Current vs. Temperature.



**FIGURE 2-23:**  $V_{DD}$  Quiescent Current vs. Input Voltage.

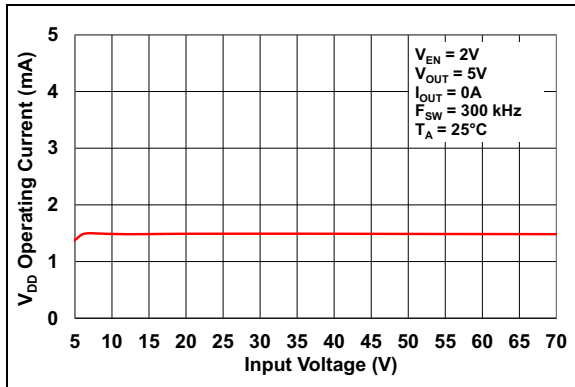


**FIGURE 2-21:**  $V_{DD}$  Voltage vs. Input Voltage.

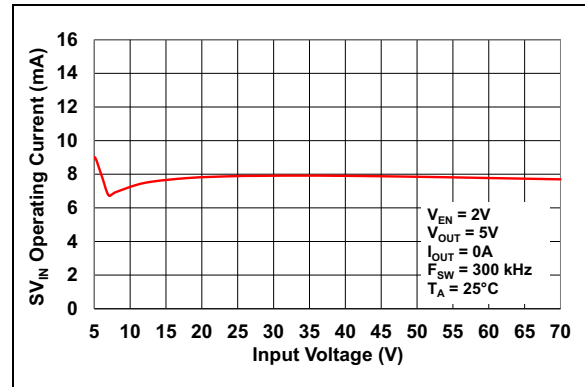


**FIGURE 2-24:**  $V_{DD}$  Quiescent Current vs. Temperature.

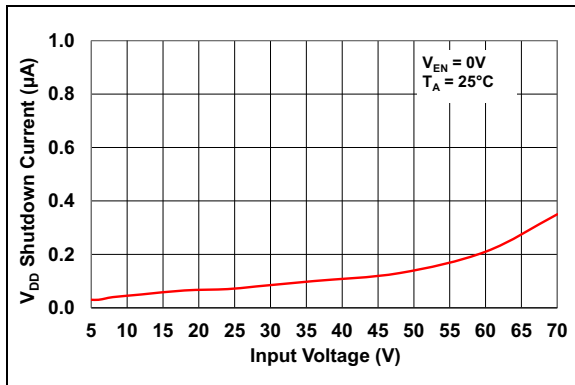
**Note:** Unless otherwise indicated,  $V_{IN} = 12V$ ,  $V_{OUT} = 5V$ ,  $I_{OUT} = 0A$ ,  $f_{SW} = 300\text{ kHz}$ ,  $R_{CL} = 2.21\text{ k}\Omega$ ,  $L = 6.8\text{ }\mu\text{H}$ .



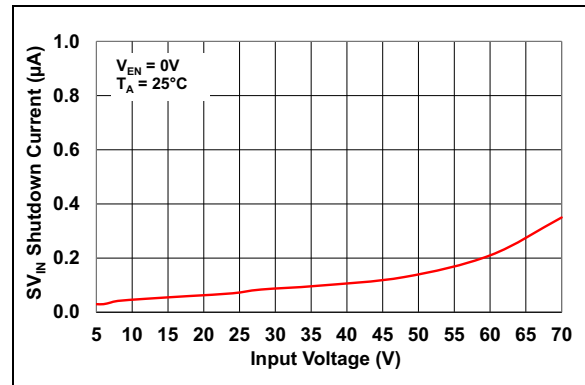
**FIGURE 2-25:**  $V_{DD}$  Operating Current vs. Input Voltage.



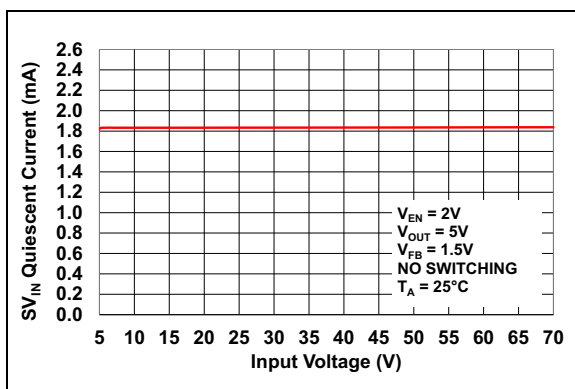
**FIGURE 2-28:**  $SV_{IN}$  Operating Current vs. Input Voltage.



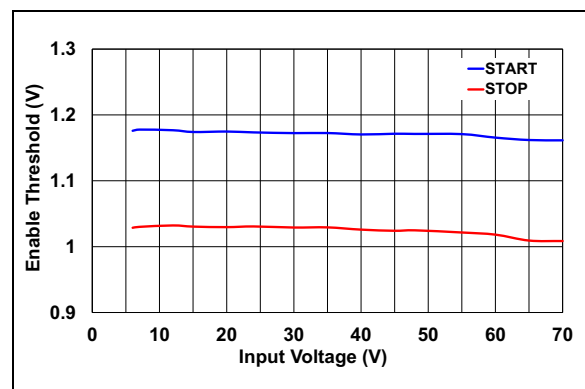
**FIGURE 2-26:**  $V_{DD}$  Shutdown Current vs. Input Voltage.



**FIGURE 2-29:**  $SV_{IN}$  Shutdown Current vs. Input Voltage.



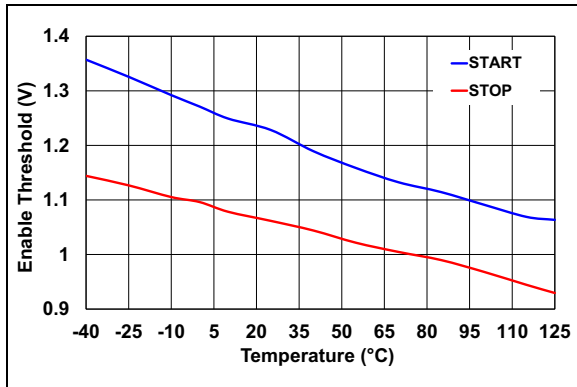
**FIGURE 2-27:**  $SV_{IN}$  Quiescent Current vs. Input Voltage.



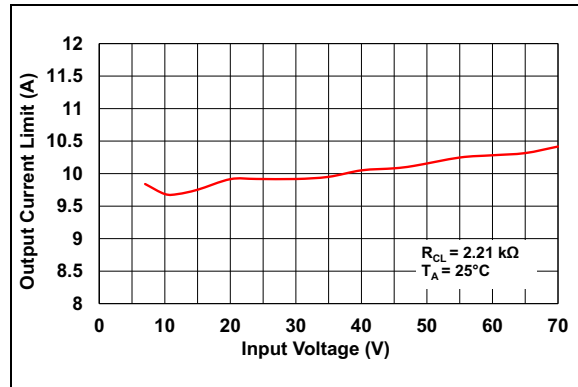
**FIGURE 2-30:** Enable Threshold vs. Input Voltage.

# MIC28516

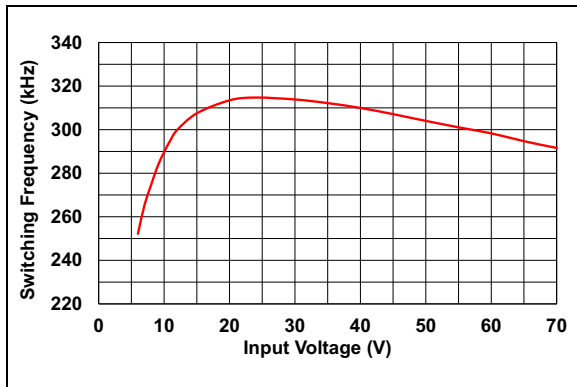
Note: Unless otherwise indicated,  $V_{IN} = 12V$ ,  $V_{OUT} = 5V$ ,  $I_{OUT} = 0A$ ,  $f_{SW} = 300\text{ kHz}$ ,  $R_{CL} = 2.21\text{ k}\Omega$ ,  $L = 6.8\text{ }\mu\text{H}$ .



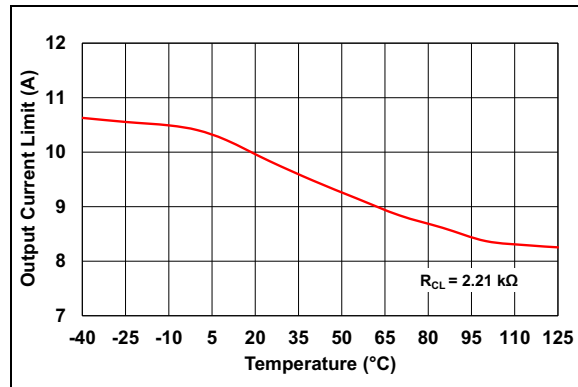
**FIGURE 2-31:** Enable Threshold vs. Temperature.



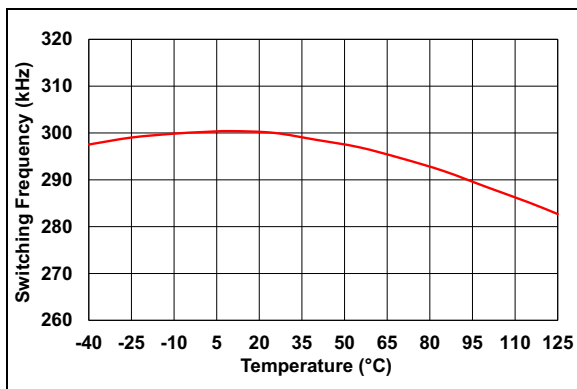
**FIGURE 2-34:** Output Current Limit vs. Input Voltage.



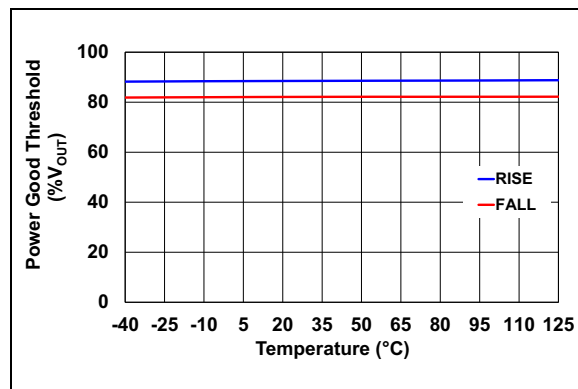
**FIGURE 2-32:** Switching Frequency vs. Input Voltage.



**FIGURE 2-35:** Output Current Limit vs. Temperature.

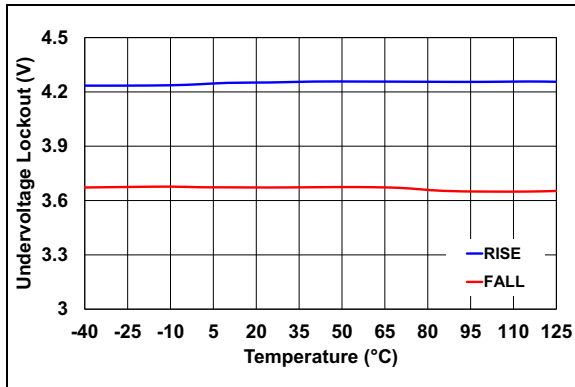


**FIGURE 2-33:** Switching Frequency vs. Temperature.

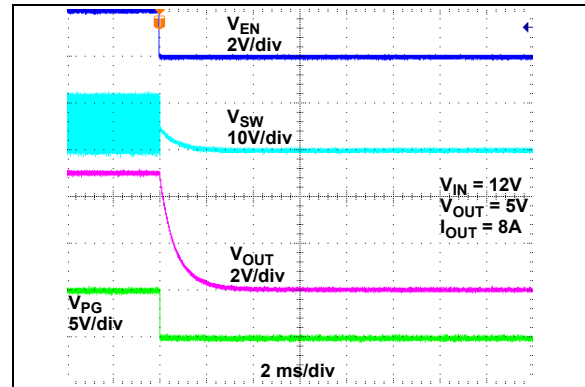


**FIGURE 2-36:** Power Good Threshold vs. Temperature.

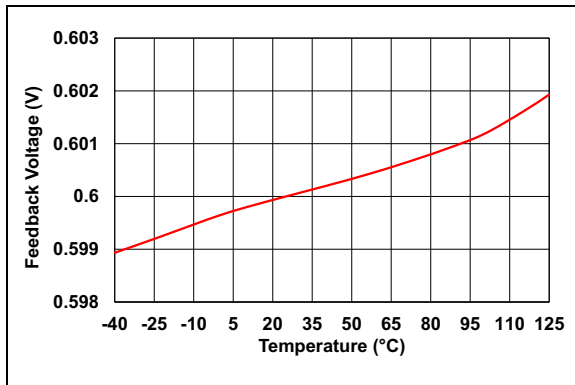
**Note:** Unless otherwise indicated,  $V_{IN} = 12V$ ,  $V_{OUT} = 5V$ ,  $I_{OUT} = 0A$ ,  $f_{SW} = 300\text{ kHz}$ ,  $R_{CL} = 2.21\text{ k}\Omega$ ,  $L = 6.8\text{ }\mu\text{H}$ .



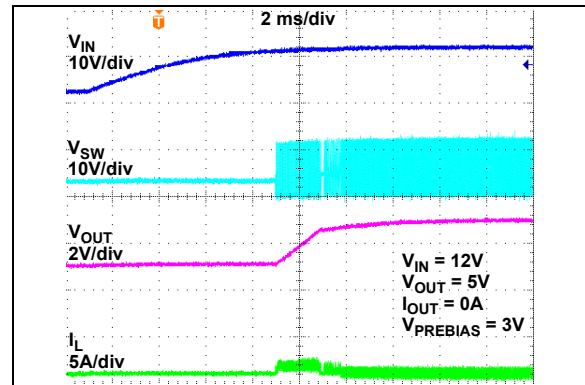
**FIGURE 2-37:** Undervoltage Lockout vs. Temperature.



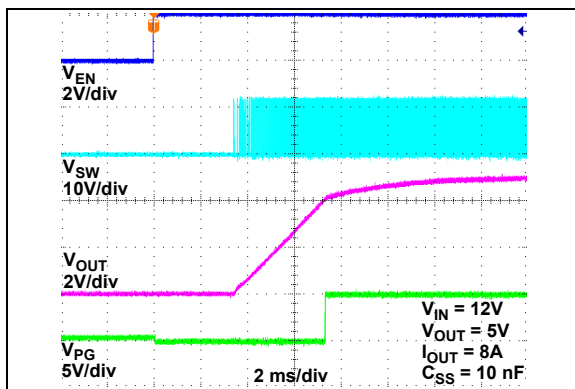
**FIGURE 2-40:** Enable Turn-Off.



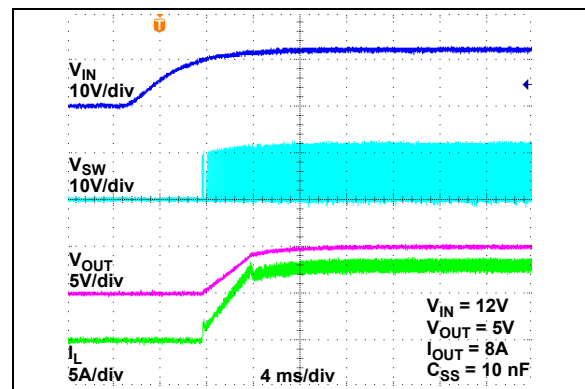
**FIGURE 2-38:** Feedback Voltage vs. Temperature.



**FIGURE 2-41:**  $V_{IN}$  Start-up Pre-Biased Output.



**FIGURE 2-39:** Enable Turn-On and Rise Time.



**FIGURE 2-42:**  $V_{IN}$  Soft Turn-On.

# MIC28516

Note: Unless otherwise indicated,  $V_{IN} = 12V$ ,  $V_{OUT} = 5V$ ,  $I_{OUT} = 0A$ ,  $f_{SW} = 300\text{ kHz}$ ,  $R_{CL} = 2.21\text{ k}\Omega$ ,  $L = 6.8\text{ }\mu\text{H}$ .

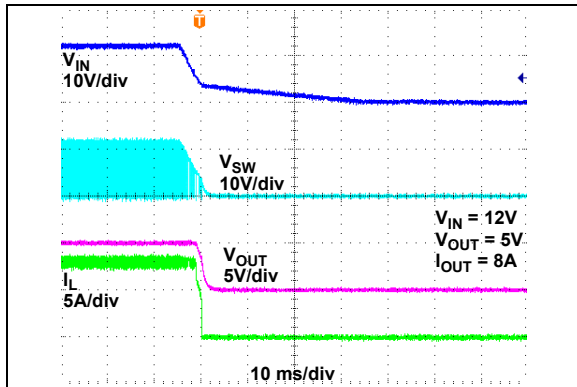


FIGURE 2-43:  $V_{IN}$  Soft Turn-Off.

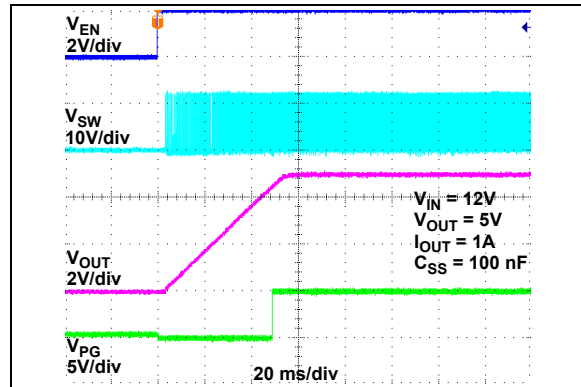


FIGURE 2-46: 40 ms Soft-Start Time.

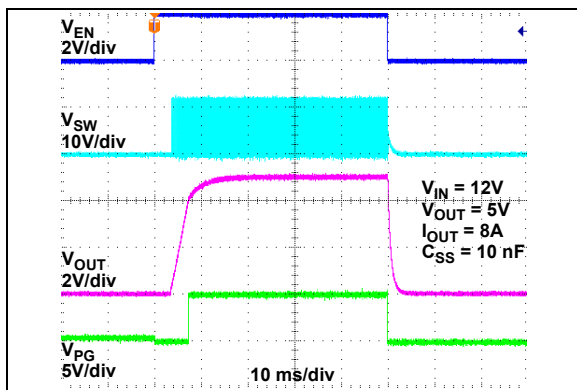


FIGURE 2-44: Enable Turn-On/Turn-Off.

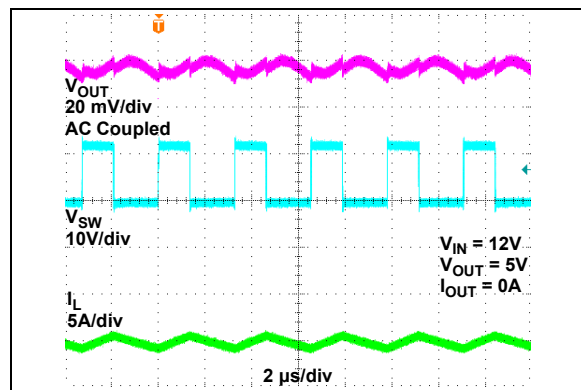


FIGURE 2-47: Switching Waveforms ( $V_{OUT} = 5V$ ,  $I_{OUT} = 0A$ ).

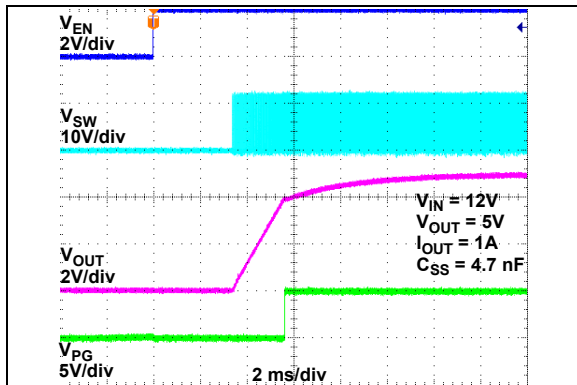


FIGURE 2-45: 2.5 ms Soft-Start Time.

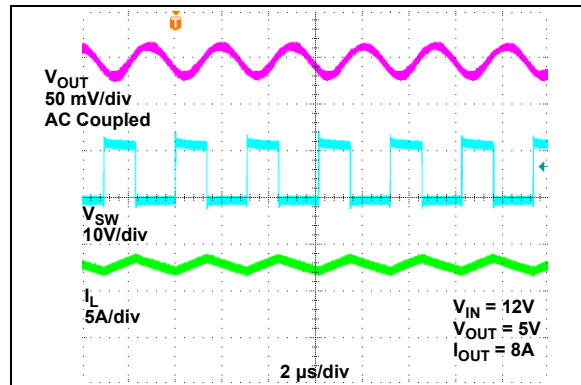
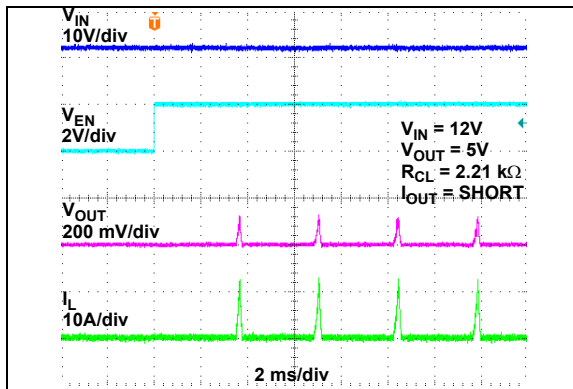
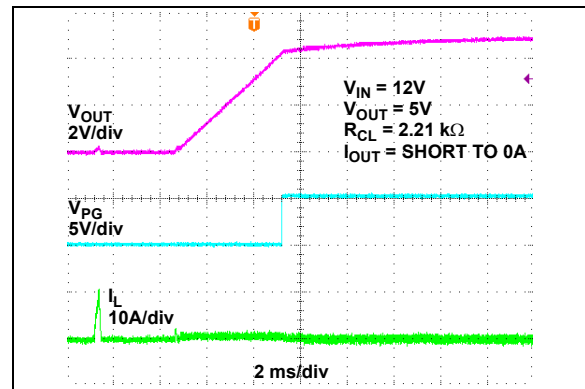


FIGURE 2-48: Switching Waveforms ( $V_{OUT} = 5V$ ,  $I_{OUT} = 8A$ ).

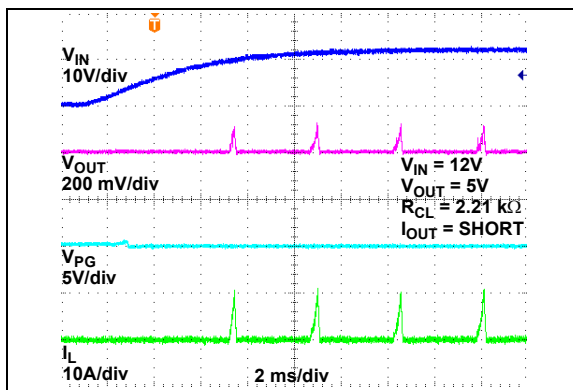
**Note:** Unless otherwise indicated,  $V_{IN} = 12V$ ,  $V_{OUT} = 5V$ ,  $I_{OUT} = 0A$ ,  $f_{SW} = 300\text{ kHz}$ ,  $R_{CL} = 2.21\text{ k}\Omega$ ,  $L = 6.8\text{ }\mu\text{H}$ .



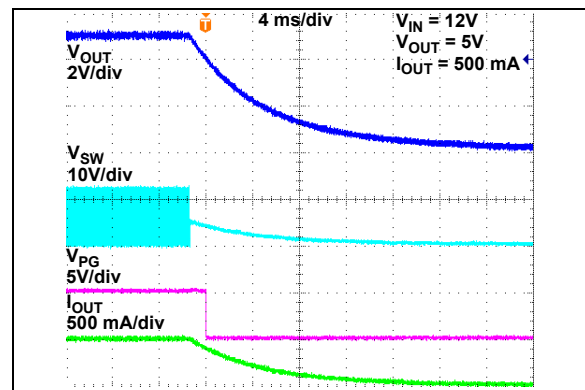
**FIGURE 2-49:** Enable into Short Circuit.



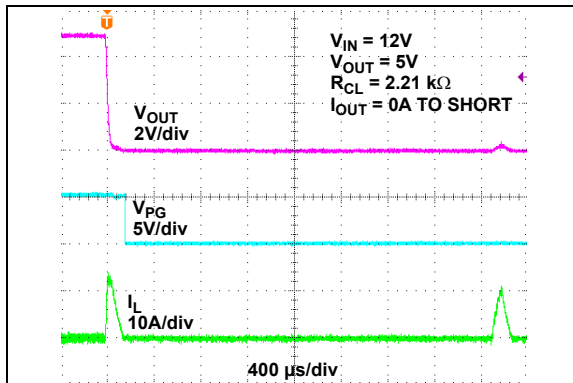
**FIGURE 2-52:** Recovery from Short Circuit.



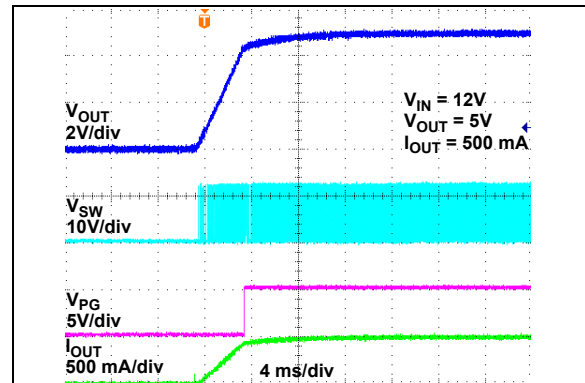
**FIGURE 2-50:** Power-Up into Short Circuit.



**FIGURE 2-53:** Behavior when Entering Thermal Shutdown.



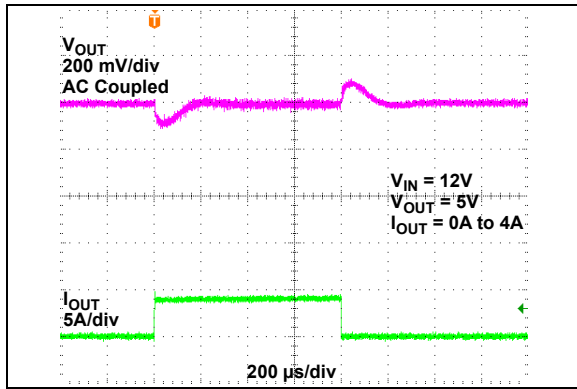
**FIGURE 2-51:** Behavior when Entering Short Circuit.



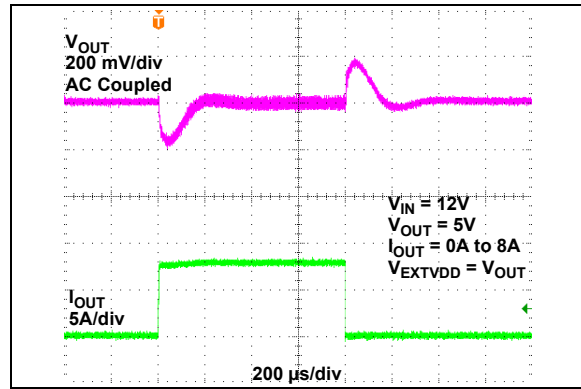
**FIGURE 2-54:** Recovery from Thermal Shutdown.

# MIC28516

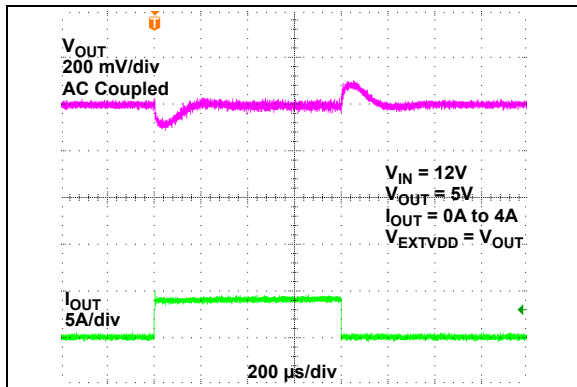
Note: Unless otherwise indicated,  $V_{IN} = 12V$ ,  $V_{OUT} = 5V$ ,  $I_{OUT} = 0A$ ,  $f_{SW} = 300\text{ kHz}$ ,  $R_{CL} = 2.21\text{ k}\Omega$ ,  $L = 6.8\text{ }\mu\text{H}$ .



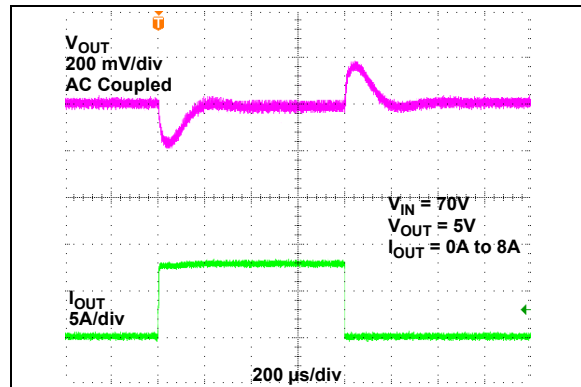
**FIGURE 2-55:** Load Transient Response ( $I_{OUT} = 0A$  to  $4A$ ).



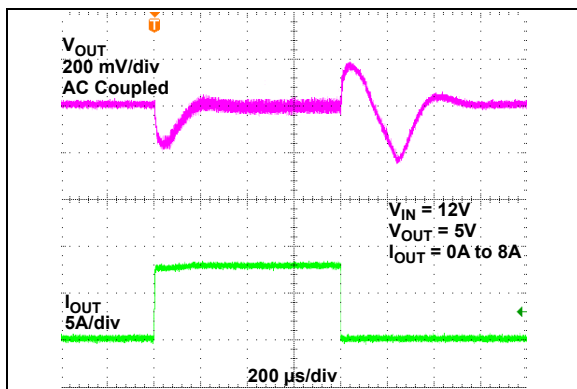
**FIGURE 2-58:** Load Transient Response ( $I_{OUT} = 0A$  to  $8A$ ,  $V_{IN} = 12V$ ,  $V_{EXTVDD} = V_{OUT}$ ).



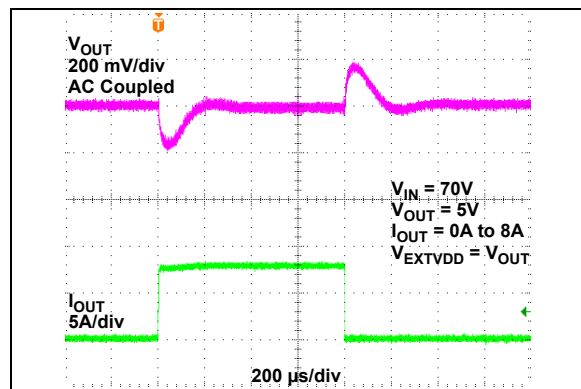
**FIGURE 2-56:** Load Transient Response ( $I_{OUT} = 0A$  to  $4A$ ,  $V_{EXTVDD} = V_{OUT}$ )



**FIGURE 2-59:** Load Transient Response ( $I_{OUT} = 0A$  to  $8A$ ,  $V_{IN} = 70V$ ).



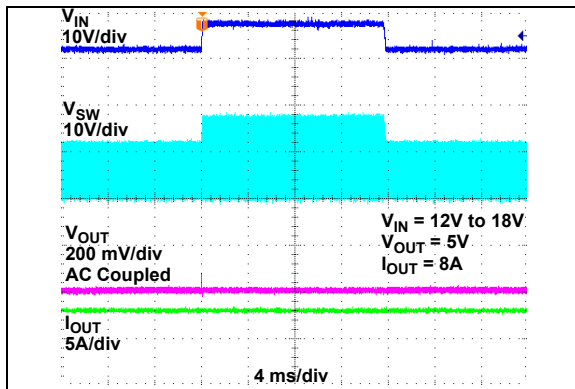
**FIGURE 2-57:** Load Transient Response ( $I_{OUT} = 0A$  to  $8A$ ,  $V_{IN} = 12V$ ).



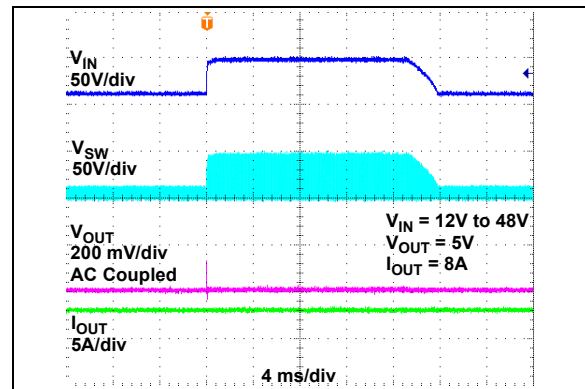
**FIGURE 2-60:** Load Transient Response ( $I_{OUT} = 0A$  to  $8A$ ,  $V_{IN} = 70V$ ,  $V_{EXTVDD} = V_{OUT}$ ).



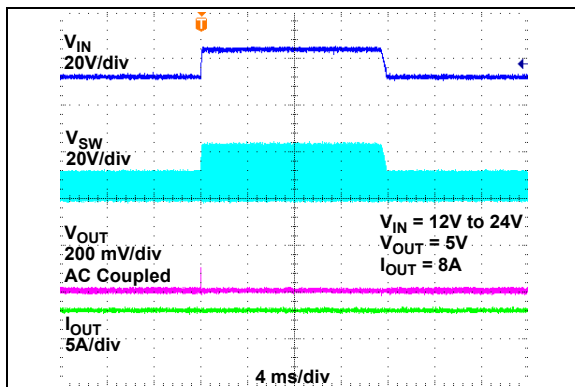
**Note:** Unless otherwise indicated,  $V_{IN} = 12V$ ,  $V_{OUT} = 5V$ ,  $I_{OUT} = 0A$ ,  $f_{SW} = 300\text{ kHz}$ ,  $R_{CL} = 2.21\text{ k}\Omega$ ,  $L = 6.8\text{ }\mu\text{H}$ .



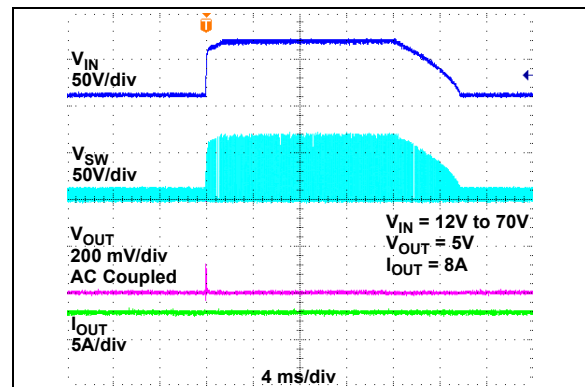
**FIGURE 2-61:** Line Transient Response ( $V_{IN} = 12V$  to  $18V$ ).



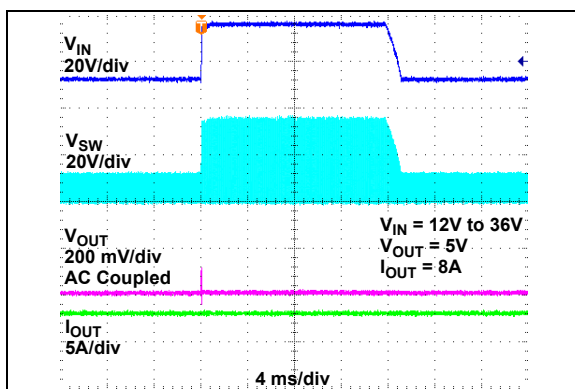
**FIGURE 2-64:** Line Transient Response ( $V_{IN} = 12V$  to  $48V$ ).



**FIGURE 2-62:** Line Transient Response ( $V_{IN} = 12V$  to  $24V$ ).



**FIGURE 2-65:** Line Transient Response ( $V_{IN} = 12V$  to  $70V$ ).



**FIGURE 2-63:** Line Transient Response ( $V_{IN} = 12V$  to  $36V$ ).

# MIC28516

## 3.0 PIN DESCRIPTIONS

The descriptions of the pins are listed in [Table 3-1](#).

**TABLE 3-1: PIN FUNCTION TABLE**

Pin Number	Symbol	Description
1	$I_{LIM}$	Current Limit Adjust Input. Connect a resistor from $I_{LIM}$ to the SW node to set the current limit. Refer to <a href="#">Section 4.3 “Current Limit”</a> for more details.
2, 16, 17, 18, 19, 22, 29	PGND	Power Ground. PGND is the ground path for the MIC28516 buck converter power stage. The PGND pin connects to the sources of the low-side N-channel internal MOSFET, the negative terminals of the input capacitors and the negative terminals of the output capacitors. The loop for the Power Ground must be as small as possible and separate from the Analog Ground (AGND) loop.
12, 13, 14, 15, 20	SW	Switch Node (Output). Internal connection for the high-side MOSFET source and low-side MOSFET drain. Connect one terminal of the inductor to the SW node.
3	SW	Switching node return to the device controller. Connect this pin to the SW node on the PCB.
4	BST	Boost Pin (Output). Bootstrapped voltage to the high-side N-channel internal MOSFET driver. An internal diode is connected between the $PV_{DD}$ pin and the BST pin. A boost capacitor of 0.1 $\mu F$ is connected between the BST pin and the SW pin.
5, 6, 7, 8, 9, 10, 11	$PV_{IN}$	High-Side Internal N-Channel MOSFET Drain Connection (Input). The $PV_{IN}$ operating voltage range is from 4.5V to 75V. Input capacitors between the $PV_{IN}$ pins and the Power Ground (PGND) are required, and the connection must be kept as short as possible.
21	$PV_{DD}$	Supply for the MOSFET Drivers. Connect to $V_{DD}$ through a 2 $\Omega$ series resistor. Connect a minimum 4.7 $\mu F$ low-ESR ceramic capacitor from $PV_{DD}$ to PGND.
23	EXTVDD	Auxiliary LDO Input. Connect to a supply higher than 4.7V (typical) to bypass the internal high-voltage LDO or leave unconnected/connected to ground when the EXTVDD pin is not used. Connect a 2.2 $\mu F$ low-ESR ceramic capacitor between EXTVDD and PGND when EXTVDD is connected to an external supply voltage in the range of 4.7V to 13.2V.
24	EN	Enable (Input). A logic level control of the output. The EN pin is CMOS-compatible. Logic high = enable, logic low = shutdown. In the OFF state, the $V_{DD}$ LDO and the buck regulator are disabled and the supply current of the device is reduced. Do not pull the EN pin above the $PV_{IN}$ supply. Do not pull the EN pin to the $V_{DD}$ for applications requiring auto power-up with $V_{IN}$ supply.
25	FREQ	Frequency Programming Input. Connect to $V_{IN}$ to set the switching frequency to 800 kHz. Connect to the midpoint of a resistor divider from $PV_{IN}$ to AGND to set the switching frequency. Refer to <a href="#">Section 5.1 “Setting the Switching Frequency”</a> .
26	SS	Soft Start Adjustment Pin. Connect a capacitor from the SS pin to AGND to adjust the soft start time. See more details in <a href="#">Section 5.0 “Application Information”</a> .
27	FB	Feedback (Input). Input to the transconductance amplifier of the control loop. The FB pin is regulated to 0.6V. A resistor divider connecting the feedback to the output is used to adjust the desired output voltage.
28	AGND	Analog Ground. Reference node for all the control logic circuits inside the MIC28516. Connect AGND to PGND at one point; see <a href="#">Section 6.0 “PCB Layout Guidelines”</a> for details.
30	$V_{DD}$	$V_{DD}$ Bias (Input). Power to the internal reference and control sections of the MIC28516. The $V_{DD}$ operating voltage range is from 4.5V to 5.5V. A 2.2 $\mu F$ ceramic capacitor from the $V_{DD}$ pin to the PGND pin must be placed next to the IC.
31	$SV_{IN}$	Input Voltage to the Internal Regulator. Powers the internal reference and control section of the MIC28516. Connect to $PV_{IN}$ through a 2 $\Omega$ resistor. Connect a 1 $\mu F$ capacitor from this pin to AGND.
32	PG	Open-Drain Power Good Output. PG is pulled to ground when the output voltage is below 90% of the target voltage. Pull-up to $V_{DD}$ through a 10 k $\Omega$ resistor to set a logic high level when the output voltage is above 90% of the target voltage.

## 4.0 FUNCTIONAL DESCRIPTION

The MIC28516 is an adaptive on-time synchronous, step-down DC/DC regulator. It is designed to operate over a wide input voltage range, from 4.5V to 70V, and provides a regulated output voltage at up to 8A of output current. An adaptive on-time control scheme is employed in order to obtain a constant switching frequency and to simplify the control compensation. Overcurrent protection is implemented with the use of an external sense resistor which sets the current limit. The device includes a programmable soft start function that reduces the power supply input surge current at start-up by controlling the output voltage rise time.

### 4.1 Theory of Operation

See [Functional Block Diagram](#). The output voltage is sensed by Feedback pin, FB, via the voltage dividers, R1 and R2, and compared to a 0.6V Reference Voltage ( $V_{REF}$ ) at the main comparator through a low-gain transconductance ( $g_m$ ) amplifier. If the feedback voltage decreases and the output of the  $g_m$  amplifier is below 0.6V, then the main comparator will trigger the control logic and generate an on-time period. The on-time period is predetermined by the fixed  $t_{ON}$  estimator circuitry value from [Equation 4-1](#):

#### EQUATION 4-1:

$$t_{ON(ESTIMATED)} = \frac{V_{OUT}}{V_{IN} \times f_{SW}}$$

Where:

$V_{OUT}$  = Output Voltage

$V_{IN}$  = Power Stage Input Voltage

$f_{SW}$  = Switching Frequency

At the end of the on-time period, the internal high-side driver turns off the high-side MOSFET and the low-side driver turns on the low-side MOSFET. The off-time period length depends upon the feedback voltage in most cases. When the feedback voltage decreases and the output of the  $g_m$  amplifier is below 0.6V, the on-time period is triggered and the off-time period ends. If the off-time period determined by the feedback voltage is less than the minimum off-time  $t_{OFF(MIN)}$  (240 ns typical), then the MIC28516 control logic will apply  $t_{OFF(MIN)}$  instead. The minimum  $t_{OFF(MIN)}$  period is required to maintain enough energy in the Boost Capacitor ( $C_{BST}$ ) to drive the high-side MOSFET.

The maximum duty cycle is obtained from the 240 ns  $t_{OFF(MIN)}$ :

#### EQUATION 4-2:

$$D_{MAX} = \frac{t_S - t_{OFF(MIN)}}{t_S} = 1 - \frac{240 \text{ ns}}{t_S}$$

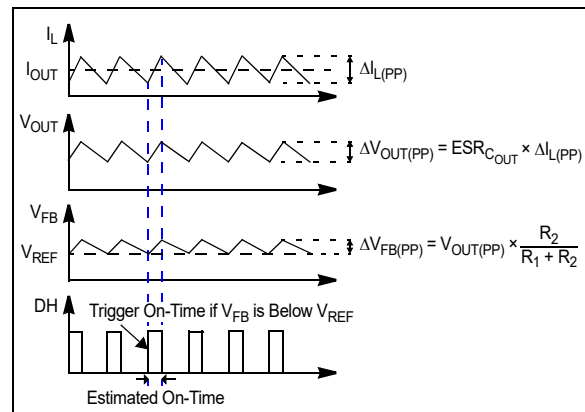
Where:

$$t_S = 1/f_{SW}$$

It is not recommended to use the MIC28516 with an off-time close to  $t_{OFF(MIN)}$  during steady-state operation.

The actual on-time and resulting switching frequency will vary with the part-to-part variation in the rise and fall times of the internal MOSFETs, the output load current and variations in the  $V_{DD}$  voltage. Also, the minimum  $t_{ON}$  results in a lower switching frequency in high  $V_{IN}$  to  $V_{OUT}$  applications, such as 70V to 1.0V.

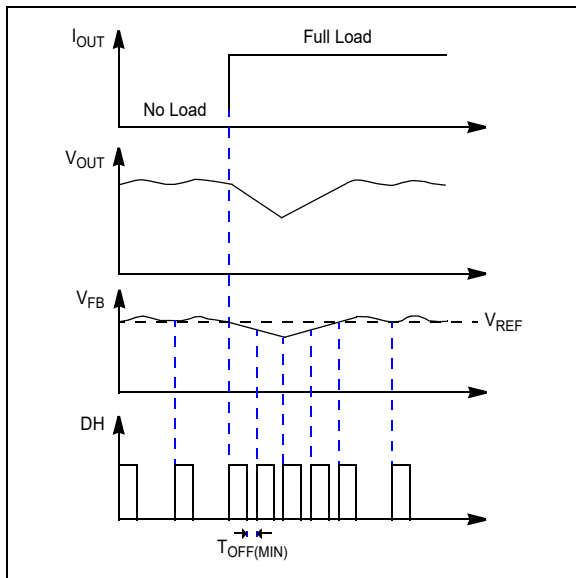
[Figure 4-1](#) shows the MIC28516 control loop timing during steady-state operation. During steady-state operation, the  $g_m$  amplifier senses the feedback voltage ripple. The feedback ripple is proportional to the output voltage ripple and the inductor current ripple to trigger the on-time period. The on-time is predetermined by the  $t_{ON}$  estimator. The termination of the off-time is controlled by the feedback voltage. At the valley of the feedback voltage ripple, which occurs when  $V_{FB}$  falls below  $V_{REF}$ , the off period ends and the next on-time period is triggered through the control logic circuitry.



**FIGURE 4-1:** MIC28516 Control Loop Timing.

# MIC28516

Figure 4-2 shows the operation of the MIC28516 during load transient. The output voltage drops due to the sudden load increase, which causes  $V_{FB}$  to be less than  $V_{REF}$ . This will cause the error comparator to trigger an on-time period. At the end of the on-time period, a minimum off-time is generated to charge  $C_{BST}$  because the feedback voltage is still below  $V_{REF}$ . Then, the next on-time period is triggered due to the low feedback voltage. Therefore, the switching frequency changes during the load transient, but returns to the nominal fixed frequency once the output has stabilized at the new load current level. With the varying duty cycle and switching frequency, the output recovery time is fast and the output voltage deviation is small in the MIC28516 converter.



**FIGURE 4-2:** MIC28516 Load Transient Response.

Unlike true Current-mode control, the MIC28516 uses the output voltage ripple to trigger an on-time period. The output voltage ripple is proportional to the inductor current ripple if the ESR of the output capacitor is high enough.

To meet the stability requirements, the MIC28516 feedback voltage ripple must be in phase with the inductor current ripple and high enough to be sensed by the  $g_m$  amplifier. The recommended feedback voltage ripple is 20 mV ~ 100 mV. If a low-ESR output capacitor is selected, then the feedback voltage ripple may be too small to be sensed by the  $g_m$  amplifier and the error comparator. Also, the output voltage ripple and the feedback voltage ripple are not necessarily in phase with the inductor current ripple if the ESR of the output capacitor is very low. For these applications, ripple injection is required to ensure proper operation. Refer to [Section 5.8 “Ripple Injection”](#) under [Section 5.0 “Application Information”](#) for details about the ripple injection technique.

## 4.2 Soft Start

Soft start reduces the power supply input surge current at start-up by controlling the output voltage rise time. The input surge appears while the output capacitor is charged up. A slower output rise time will draw a lower input surge current.

The MIC28516 features an adjustable soft start time. The soft start time can be adjusted by tuning the value of the capacitor connected from the SS pin to AGND. The soft start time can be adjusted from 5 ms to 100 ms. The MIC28516 forces 1.4  $\mu\text{A}$  current from the SS pin. This constant current flows through the capacitor, connected from the SS pin to AGND, to adjust the soft start time.

## 4.3 Current Limit

The MIC28516 uses the low-side MOSFET  $R_{DS(ON)}$  to sense the inductor current. In each switching cycle, the inductor current is sensed by monitoring the voltage across the low-side MOSFET during the off period of the switching cycle, during which the low-side MOSFET is on. An internal current source of 96  $\mu\text{A}$  generates a voltage across the external Current Limit Setting Resistor,  $R_{CL}$ .

The  $I_{LIM}$  Pin Voltage ( $V_{ILIM}$ ) is the difference between the voltage across the low-side MOSFET and the voltage across the resistor ( $V_{RCL}$ ). The sensed voltage,  $V_{ILIM}$ , is compared with the Power Ground (PGND) after a blanking time of 150 ns.

If the absolute value of the voltage drop across the low-side MOSFET is greater than the absolute value of the voltage across the current setting resistor ( $V_{RCL}$ ), the MIC28516 triggers the current limit event. Eight consecutive current limit events trigger the Hiccup mode. Once the controller enters into Hiccup mode, it initiates a soft start sequence after a hiccup time-out of 4 ms (typical). Both the high-side and low-side MOSFETs are turned off during a hiccup time-out. The hiccup sequence, including the soft start, reduces the stress on the switching FETs, and protects the load and supply from severe short conditions.

The MOSFET  $R_{DS(ON)}$  varies from 30% to 40% with temperature; therefore, it is recommended to consider the  $R_{DS(ON)}$  variation while calculating  $R_{CL}$  (see [Equation 5-5](#)), to avoid false current limiting due to increased MOSFET junction temperature rise.

To improve the current limit variation, the MIC28516 adjusts the internal Current Limit Source Current ( $I_{CL}$ ) at a rate of 0.3  $\mu\text{A}/^\circ\text{C}$  when the junction temperature changes to compensate the  $R_{DS(ON)}$  variation of the low-side MOSFET. [Figure 2-35](#) indicates the temperature variation of the current limit with  $R_{CL} = 2.21 \text{ k}\Omega$ .

A small capacitor ( $C_{CL}$ ) can be connected from the  $I_{LIM}$  pin to PGND to filter the switch node ringing during the off period, allowing better current sensing. The time constant of  $R_{CL}$  and  $C_{CL}$  must be less than the minimum off-time.

## 4.4 Negative Current Limit

The MIC28516 implements a negative current limit by sensing the SW voltage when the low-side MOSFET is on. If the SW node voltage exceeds 48 mV (typical) or an equivalent of 2.7A, the device turns off the low-side MOSFET for 500 ns.

### EQUATION 4-3:

$$I_{Neg\_Limit} = V_{th\_SW}/R_{DS}$$

Where:

$V_{th\_SW}$  = Switching Node Voltage (48 mV)

$R_{DS}$  = Drain to Source Resistance for Low-Side MOSFET (18 m $\Omega$ )

$$I_{Neg\_Limit} = 0.048/0.018 = 2.66A$$

## 4.5 Internal MOSFET Gate Drive

The [Functional Block Diagram](#) shows a bootstrap circuit consisting of an internal diode from  $PV_{DD}$  to BST and an external capacitor connected from the SW pin to the BST pin ( $C_{BST}$ ). This circuit supplies energy to the high-side drive circuit. Capacitor  $C_{BST}$  is charged while the low-side MOSFET is on and the voltage on the SW pin is approximately 0V. Energy from  $C_{BST}$  is used to turn on the high-side MOSFET. As the high-side MOSFET turns on, the voltage on the SW pin increases to approximately  $V_{IN}$ . The internal diode is reverse-biased and  $V_{BST}$  floats high while continuing to keep the high-side MOSFET on. The bias current of the high-side driver is less than 10 mA, so 0.1  $\mu$ F to 1  $\mu$ F is sufficient to hold the gate voltage with minimal droop for the power stroke (high-side switching) cycle (i.e.,  $\Delta V_{CBST} = 10 \text{ mA} \times 4 \mu\text{s}/0.1 \mu\text{F} = 400 \text{ mV}$ ). When the low-side MOSFET is turned back on,  $C_{BST}$  is recharged through D1. A small resistor in series with  $C_{BST}$  can be used to slow down the turn-on time of the high-side N-channel MOSFET.

The drive voltage is derived from the  $PV_{DD}$  supply voltage. The nominal low-side gate drive voltage is  $PV_{DD}$  and the nominal high-side gate drive voltage is approximately  $PV_{DD} - V_{DIODE}$ , where  $V_{DIODE}$  is the voltage drop across the internal diode. A delay of approximately 30 ns between the high-side and low-side driver transitions is used to prevent current from simultaneously flowing unimpeded through both MOSFETs.

## 4.6 Auxiliary Bootstrap LDO (EXTVDD)

The MIC28516 features an auxiliary bootstrap LDO, which improves the system efficiency by supplying the internal circuit bias power and gate drivers from the converter output voltage. This LDO is enabled when the voltage on the EXTVDD pin is higher than 4.6V (typical), and at the same time, the main LDO, which operates from  $V_{IN}$ , is disabled to reduce power consumption.

# MIC28516

## 5.0 APPLICATION INFORMATION

### 5.1 Setting the Switching Frequency

The MIC28516 is an adjustable frequency, synchronous buck regulator that features an adaptive on-time control architecture. The switching frequency can be adjusted between 270 kHz and 800 kHz by changing the resistor divider network, consisting of  $R_3$  and  $R_4$ .

Equation 5-1 gives the estimated switching frequency:

#### EQUATION 5-1:

$$f_{SW(ADJ)} = f_O \times \frac{R_3}{R_3 + R_4}$$

Where:

$f_O$  = Switching Frequency when  $R_4$  is 100 k $\Omega$  and  $R_3$  is Open;  $f_O$  is typically 800 kHz

### 5.2 Setting the Soft Start Time

The output soft start time can be set by connecting a capacitor from the SS pin to the AGND pin.

The value of the capacitor can be calculated using Equation 5-2:

#### EQUATION 5-2:

$$C_{SS} = \frac{I_{SS} \times t_{SS}}{V_{REF}}$$

Where:

$C_{SS}$  = Capacitor from SS Pin to AGND

$I_{SS}$  = Internal Soft Start Current (1.4  $\mu$ A, typical)

$t_{SS}$  = Output Soft Start Time

$V_{REF}$  = 0.6V

### 5.3 Setting the Output Voltage

The MIC28516 requires two resistors to set the output voltage, as shown in Figure 5-1:

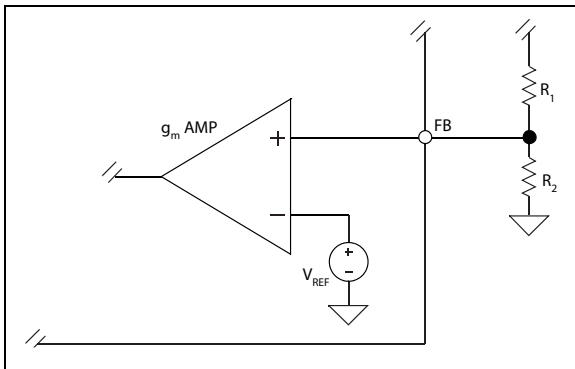


FIGURE 5-1: Voltage Divider Configuration.

The output voltage is determined by Equation 5-3:

#### EQUATION 5-3:

$$V_O = V_{FB} \times \left(1 + \frac{R_1}{R_2}\right)$$

Where:

$V_{FB}$  = 0.6V

A typical value of  $R_1$  can vary between 3 k $\Omega$  and 10 k $\Omega$ . If  $R_1$  is too large, it may allow noise to be introduced into the voltage feedback loop. If  $R_1$  is too small, it will decrease the efficiency of the power supply, especially at light loads. Once  $R_1$  is selected,  $R_2$  can be calculated using Equation 5-4:

#### EQUATION 5-4:

$$R_2 = \frac{V_{FB} \times R_1}{V_{OUT} - V_{FB}}$$

### 5.4 Setting the Current Limit

The Source Current Limit ( $I_{CL}$ ) is trimmed at the factory to achieve a higher current limit accuracy with  $R_{CL} = 2.21$  k $\Omega$ , as specified in Table 1-1 in Section 1.0 "Electrical Characteristics". It is possible to adjust other current limits by changing the  $R_{CL}$  value using Equation 5-5:

#### EQUATION 5-5:

$$R_{CL} = \frac{\left(I_{LIM} + \frac{\Delta I_{L(PP)}}{2}\right) \times R_{DS(ON)}}{I_{CL}}$$

Where:

$I_{LIM}$  = Load Current Limit

$R_{DS(ON)}$  = On-Resistance of the Low-Side MOSFET (18 m $\Omega$ , typical)

$\Delta I_{L(PP)}$  = Inductor Ripple Current

$I_{CL}$  = Current Limit Source Current (96  $\mu$ A, typical)

## 5.5 Inductor Selection

Values for inductance, peak and RMS currents are required to select the inductor. The input voltage, output voltage, switching frequency and the inductance value determine the peak-to-peak inductor ripple current. Generally, higher inductance values are used with higher input voltages. Larger peak-to-peak ripple currents will increase the power dissipation in the inductor and MOSFETs. Larger output ripple currents will also require more output capacitance to smooth out the larger ripple current. Smaller peak-to-peak ripple currents require a larger inductance value, and therefore, a larger and more expensive inductor. A good compromise between size, loss and cost is to set the inductor ripple current to be equal to 20% of the maximum output current. The inductance value is calculated by [Equation 5-6](#):

### EQUATION 5-6:

$$L = \frac{V_{OUT} \times (V_{IN(MAX)} - V_{OUT})}{V_{IN(MAX)} \times f_{SW} \times 20\% \times I_{OUT(MAX)}}$$

Where:

$f_{SW}$  = Switching Frequency

20% = Ratio of AC Ripple Current to DC Output Current

$V_{IN(MAX)}$  = Maximum Power Stage Input Voltage

For a selected inductor, the peak-to-peak inductor current ripple is:

### EQUATION 5-7:

$$\Delta I_{L(PP)} = \frac{V_{OUT} \times (V_{IN} - V_{OUT})}{V_{IN} \times f_{SW} \times L}$$

The peak inductor current is equal to the average output current plus one-half of the peak-to-peak inductor current ripple.

### EQUATION 5-8:

$$I_{L(PK)} = I_{OUT} + 0.5 \times \Delta I_{L(PP)}$$

The RMS inductor current is used to calculate the  $I^2R$  losses in the inductor.

### EQUATION 5-9:

$$I_{L(RMS)} = \sqrt{I_{OUT}^2 + \frac{\Delta I_{L(PP)}^2}{12}}$$

Maximizing efficiency requires the proper selection of core material while minimizing the winding resistance. The high-frequency operation of the MIC28516 requires the use of ferrite materials for all but the most cost-sensitive applications. Lower cost iron powder cores may be used, but the increase in core loss will reduce the efficiency of the power supply. This is especially noticeable at low output power. The winding resistance decreases efficiency at the higher output current levels. The winding resistance must be minimized, although this usually comes at the expense of a larger inductor. The power dissipated in the inductor is equal to the sum of the core and copper losses. At higher output loads, the core losses are usually insignificant and can be ignored. At lower output currents, the core losses can be significant. Core loss information is usually available from the magnetics vendor. Copper loss in the inductor is calculated by [Equation 5-10](#):

### EQUATION 5-10:

$$P_{INDUCTOR(CU)} = I_{L(RMS)}^2 \times R_{WINDING}$$

The resistance of the copper wire,  $R_{WINDING}$ , increases with the temperature. The value of the winding resistance used must be at the operating temperature.

### EQUATION 5-11:

$$R_{WINDING(HT)} = R_{WINDING(20C)} \times (1 + 0.004 \times (T_H - T_{20C}))$$

Where:

$T_H$  = Temperature of Wire Underload

$T_{20C}$  = Ambient Room Temperature

$R_{WINDING(20C)}$  = Room Temperature Winding Resistance (usually specified by the manufacturer)

## 5.6 Output Capacitor Selection

The type of output capacitor is usually determined by its Equivalent Series Resistance (ESR). Voltage and RMS current capability are two other important factors for selecting the output capacitor. Recommended capacitor types are ceramic, low-ESR aluminum electrolytic, OS-CON and POSCAP. The output capacitor's ESR is usually the main cause of the output ripple. The output capacitor ESR also affects the control loop from a stability point of view. The maximum value of the ESR is calculated using [Equation 5-12](#):

### EQUATION 5-12:

$$ESR_{COUT} \leq \frac{\Delta V_{OUT(PP)}}{\Delta I_{L(PP)}}$$

Where:

$\Delta V_{OUT(PP)}$  = Peak-to-Peak Output Voltage Ripple

$\Delta I_{L(PP)}$  = Peak-to-Peak Inductor Current Ripple

The total output ripple is a combination of ripple voltages due to the ESR and output capacitance. The total ripple is calculated in [Equation 5-13](#):

### EQUATION 5-13:

$$\Delta V_{OUT(PP)} = \sqrt{\left(\frac{\Delta I_{L(PP)}}{C_{OUT} \times f_{SW} \times 8}\right)^2 + (\Delta I_{L(PP)} \times ESR_{COUT})^2}$$

Where:

$C_{OUT}$  = Output Capacitance Value

$f_{SW}$  = Switching Frequency

As described in [Section 4.1 "Theory of Operation"](#), a subsection of [Section 4.0 "Functional Description"](#), the MIC28516 requires at least 20 mV of peak-to-peak ripple at the FB pin for the  $g_m$  amplifier and the error comparator to behave properly. Also, the output voltage ripple must be in phase with the inductor current. Therefore, the output voltage ripple caused by the output capacitance value must be much lower than the ripple caused by the output capacitor ESR. If low-ESR capacitors, such as ceramic capacitors, are selected as the output capacitors, a ripple injection method must be applied to provide enough feedback voltage ripple. Refer to [Section 5.8 "Ripple Injection"](#) for details.

It is recommended that the voltage rating of the capacitor be 20% greater than the output voltage for aluminum electrolytic or OS-CON capacitor. The output capacitor RMS current is calculated in [Equation 5-14](#):

### EQUATION 5-14:

$$I_{COUT(RMS)} = \frac{\Delta I_{L(PP)}}{\sqrt{12}}$$

The power dissipated in the output capacitor is:

### EQUATION 5-15:

$$P_{DISS(COUT)} = I_{COUT(RMS)}^2 \times ESR_{COUT}$$

## 5.7 Input Capacitor Selection

The input capacitor for the power stage input,  $V_{IN}$ , must be selected for ripple current rating and voltage rating. Tantalum input capacitors may fail when subjected to high inrush currents caused by turning on the input supply. It is recommended that a tantalum input capacitor's voltage rating be at least two times the maximum input voltage to maximize reliability. Aluminum electrolytic, OS-CON and multilayer polymer film capacitors can handle the higher inrush currents without voltage derating. The input voltage ripple will primarily depend on the input capacitor's ESR. The peak input current is equal to the peak inductor current, therefore:

### EQUATION 5-16:

$$\Delta V_{IN} = I_{L(PK)} \times ESR_{CIN}$$

The input capacitor must be rated for the input current ripple. The RMS value of the input capacitor current is determined at the maximum output current. Assuming the peak-to-peak inductor current ripple is low:

### EQUATION 5-17:

$$I_{CIN(RMS)} \approx I_{OUT(MAX)} \times \sqrt{D \times (1-D)}$$

The power dissipated in the input capacitor is:

### EQUATION 5-18:

$$P_{DISS(CIN)} = I_{CIN(RMS)}^2 \times ESR_{CIN}$$

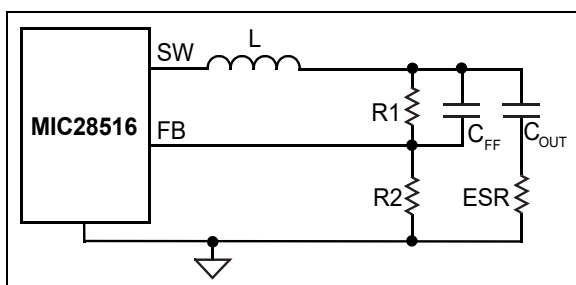


## 5.8 Ripple Injection

The  $V_{FB}$  ripple required for proper operation of the MIC28516  $g_m$  amplifier and comparator is 20 mV to 100 mV. However, the output voltage ripple is generally designed as 1% to 2% of the output voltage. For low output voltages, such as 1V, the output voltage ripple is only 10 mV to 20 mV and the feedback voltage ripple is less than 20 mV. If the feedback voltage ripple is so low that the  $g_m$  amplifier and comparator cannot sense it, then the MIC28516 loses control and the output voltage is not regulated. To have a sufficient  $V_{FB}$  ripple, a ripple injection method must be applied for low output voltage ripple applications.

The applications are divided into three situations according to the amount of the feedback voltage ripple:

1. Enough ripple at the feedback voltage due to the large ESR of the output capacitors (Figure 5-2). The converter is stable without any ripple injection.



**FIGURE 5-2:** Enough Ripple at FB.

The feedback voltage ripple is:

### EQUATION 5-19:

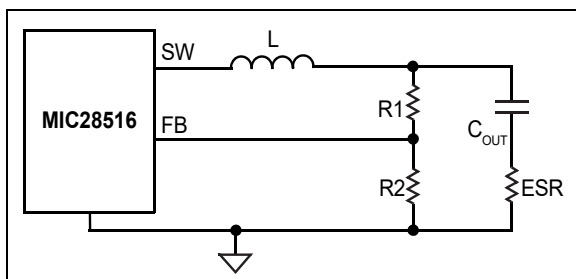
$$\Delta V_{FB(PP)} = \frac{R_2}{R_1 + R_2} \times ESR_{COUT} \times \Delta I_L(PP)$$

Where:

$\Delta I_L(PP)$  = Peak-to-Peak Value of the Inductor Current Ripple

2. Inadequate ripple at the feedback voltage due to the small ESR of the output capacitors.

In this situation, the output voltage ripple is fed into the FB pin through a Feed-Forward Capacitor,  $C_{ff}$ , as shown in Figure 5-3. The typical  $C_{ff}$  value is between 1 nF and 22 nF.



**FIGURE 5-3:** Inadequate Ripple at FB.

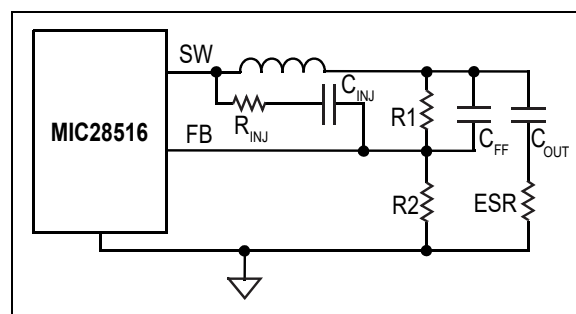
With the feed-forward capacitor, the feedback voltage ripple is very close to the output voltage ripple.

### EQUATION 5-20:

$$\Delta V_{FB(PP)} \approx ESR_{COUT} \times \Delta I_L(PP)$$

3. Virtually no ripple at the FB pin voltage due to the very low-ESR of the output capacitors.

In this situation, the output voltage ripple is less than 20 mV. Therefore, an additional ripple is injected into the FB pin from the Switching Node, SW, via a resistor,  $R_{INJ}$ , and a capacitor,  $C_{INJ}$ , as shown in Figure 5-4.



**FIGURE 5-4:** Invisible Ripple at FB.

The injected ripple is:

### EQUATION 5-21:

$$\Delta V_{FB(PP)} = V_{IN} \times K_{DIV} \times D \times (1 - D) \times \frac{I}{f_{SW} \times \tau}$$

Where:

$V_{IN}$  = Power Stage Input Voltage

$D$  = Duty Cycle

$f_{SW}$  = Switching Frequency

$\tau = (R_1 // R_2 // R_{INJ}) \times C_{ff}$

### EQUATION 5-22:

$$K_{DIV} = \frac{R_1 // R_2}{R_{INJ} + R_1 // R_2}$$

In Equation 5-21 and Equation 5-22, it is assumed that the time constant associated with  $C_{ff}$  must be much greater than the switching period:

### EQUATION 5-23:

$$\frac{I}{f_{SW} \times \tau} = \frac{T}{\tau} \ll 1$$

If the voltage divider resistors, R1 and R2, are in the kΩ range, a C<sub>ff</sub> of 1 nF to 22 nF can easily satisfy the large time constant requirements. Also, a 100 nF Injection Capacitor, C<sub>INJ</sub>, is used in order to be considered as short for a wide range of the frequencies.

The process of sizing the ripple injection resistor and capacitors is as follows:

1. Select C<sub>ff</sub> to feed all output ripples into the Feedback pin and make sure the large time constant assumption is satisfied. A typical choice for C<sub>ff</sub> is 1 nF to 22 nF if R<sub>1</sub> and R<sub>2</sub> are in the kΩ range.
2. Select R<sub>INJ</sub> according to the expected feedback voltage ripple using [Equation 5-24](#):

#### EQUATION 5-24:

$$K_{DIV} = \frac{\Delta V_{FB(PP)}}{V_{IN}} \times \frac{f_{SW} \times \tau}{D \times (1-D)}$$

Then, the value of R<sub>INJ</sub> is obtained as:

#### EQUATION 5-25:

$$R_{INJ} = (R1//R2) \times \left( \frac{1}{K_{DIV}} - 1 \right)$$

3. Select C<sub>INJ</sub> as 100 nF, which could be considered as short for a wide range of the frequencies.

## 5.9 Thermal Measurements

Measuring the IC's case temperature is recommended to ensure it is within its operating limits. Although this might seem like a trivial task, it is easy to get erroneous results. The most common mistake is to use the standard thermocouple that comes with a thermal meter. This thermocouple wire gauge is large, typically 22 gauge, and behaves like a heat sink, resulting in a lower case temperature measurement.

Two methods of temperature measurement are using a smaller thermocouple wire or an infrared thermometer. If a thermocouple wire is used, it must be constructed of 36 gauge wire or higher (smaller wire size) to minimize the wire heat sinking effect. In addition, the thermocouple tip must be covered in either thermal grease or thermal glue to make sure that the thermocouple junction is making good contact with the case of the IC.

Wherever possible, an infrared thermometer is recommended. An optional stand makes it easy to hold the beam on the IC for long periods of time.

## 5.10 Output Current Thermal Derating with SOA at High Input Voltage

For the MIC28516 at  $V_{IN} = 70V$ ,  $V_{OUT} = 5V$ ,  $T_A = +25^\circ C$ , the Maximum Output Current,  $I_{OUT(MAX)}$ , is about 7.2A, as  $I_{OUT(MAX)}$  starts derating to less than 8A at a  $T_A$  of around  $+15^\circ C$ .  $I_{OUT(MAX)}$  further decreases as the ambient temperature increases. When output current derating starts,  $I_{OUT(MAX)}$  is inversely proportional to the device package thermal resistance,  $\theta_{JA}$ , and Output Voltage,  $V_{OUT}$ , and is directly proportional to the factor,  $\eta/(1 - \eta)$ , where  $\eta$  is the converter efficiency.

The derate starting ambient temperature depends on the Maximum Operating Junction Temperature,  $T_{J(MAX)}$ , the Maximum Output Current,  $I_{OUT(MAX)}$  without derating (which is the desired maximum output Current Limit,  $I_{CLIM}$ ), the Output Voltage,  $V_{OUT}$ , the device package thermal resistance,  $\theta_{JA}$ , and the factor,  $(1 - \eta)/\eta$ .

The maximum output current of MIC28516 with the device at the Maximum Junction Temperature,  $T_{J(MAX)}$ , operating over the Ambient Temperature,  $T_A$ , range can be estimated by [Equation 5-26](#):

### EQUATION 5-26:

$$I_{OMAX(TJMAX)} = \left( -\frac{I}{\theta_{JA}} \times T_A + \left( \frac{T_{J(MAX)}}{\theta_{JA}} + P_{D(L)} \right) \right) \times \left( \frac{\eta}{V_{OUT} \times (1 - \eta)} \right)$$

Where:

- $\theta_{JA}$  = Device Package Thermal Resistance, which is  $33.3^\circ C/W$  for the 6 mm × 6 mm 32-Lead VQFN
- $\eta$  = Buck Converter Efficiency: About 78% for  $V_{OUT} = 5V$  at  $V_{IN} = 70V$ , 85% at  $V_{IN} = 48V$ , 88% at  $V_{IN} = 36V$
- $T_{J(MAX)}$  = Device Maximum Operating Junction Temperature, which is  $+125^\circ C$
- $T_A$  = Ambient Temperature
- $V_{OUT}$  = Output Voltage
- $P_{D(L)}$  = Inductor Power Dissipation due to DCR

The inductor power dissipation, due to DCR, in the above [Equation 5-26](#) can be approximated by [Equation 5-27](#):

### EQUATION 5-27:

$$P_{D(L)} \approx I_{OUT}^2 \times DCR$$

Where:

- $I_{OUT}$  = Output Current
- $DCR$  = Power Inductor DC Resistance

The maximum output current without thermal derating in the SOA curve is equal to the desired Output Current Limit,  $I_{CLIM}$ ; therefore, the maximum output current in the SOA curve can be defined by [Equation 5-28](#):

### EQUATION 5-28:

$$I_{OUT(MAX)} = \begin{cases} I_{CLIM} & \text{for } T_A \leq T_{A(DS)} \\ I_{OMAX(TJMAX)} & \text{for } T_A \geq T_{A(DS)} \end{cases}$$

Where:

- $I_{CLIM}$  = Desired Output Current Limit
- $T_{A(DS)}$  = Derate Starting Ambient Temperature

The derate starting ambient temperature can be predicted using [Equation 5-29](#):

### EQUATION 5-29:

$$T_{A(DS)} \approx T_{J(MAX)} - \left( I_{CLIM} \times V_{OUT} \times \frac{1 - \eta}{\eta} - P_{D(L)} \right) \times \theta_{JA}$$

# MIC28516

---

If  $I_{OUT(MAX)}$  starts derating at an ambient temperature lower than the user's actual Maximum Operating Ambient Temperature,  $T_{A(MAX,OP)}$ , the  $I_{OUT(MAX)}$  at  $T_{A(MAX,OP)}$  in the SOA curve will be less than the desired Output Current Limit,  $I_{CLIM}$ . Then, the desired

Output Current Limit,  $I_{CLIM}$ , needs to be reduced to avoid the actual operating output current being out of the SOA curve boundary and to ensure safe operation. The output current limit in such condition can be estimated by [Equation 5-30](#):

## EQUATION 5-30:

$$I_{CLIM} \leq \left[ \frac{T_{J(MAX)} - T_{A(MAX,OP)}}{\theta_{JA}} + P_{D(L)} \right] \times \left[ \frac{\eta}{V_{OUT} \times (1 - \eta)} \right]$$

Where:

$T_{A(MAX,OP)}$  = User's Actual Maximum Operating Ambient Temperature

$T_{J(MAX)}$  = Device Maximum Operating Junction Temperature, which is +125°C

$\theta_{JA}$  = Device Package Thermal Resistance, which is 33.3°C/W for the 6 mm × 6 mm 32-Lead VQFN

## 6.0 PCB LAYOUT GUIDELINES

PCB layout is critical to achieve reliable, stable and efficient performance. A ground plane is required to control EMI and minimize the inductance in the power, signal and return paths. The thickness of the copper planes is also important for dissipating heat. A 2 oz. copper thickness is adequate from a thermal point of view and a thick copper plane helps in terms of noise immunity. Keep in mind, thinner planes can be easily penetrated by noise. The following guidelines must be followed to ensure proper operation of the MIC28516 converter.

### 6.1 IC

- The 2.2  $\mu\text{F}$  ceramic capacitor, which is connected to the  $V_{\text{DD}}$  pin, must be located right at the IC. The  $V_{\text{DD}}$  pin is very noise-sensitive and placement of the capacitor is critical. Use wide traces to connect to the  $V_{\text{DD}}$  pin.
- The Analog Ground (AGND) pin must be connected directly to the ground planes. The AGND and PGND connection must be done at a single point near the IC. Do not route the AGND pin to the PGND pad on the top layer.
- Use thick traces to route the input and output power lines.

### 6.2 Input Capacitor

- Place the input capacitor next to the power pins.
- Place the input capacitors on the same side of the board and as close to the IC as possible.
- Keep both the  $PV_{\text{IN}}$  pin and PGND connections short.
- Place several vias to the ground plane, close to the input capacitor ground terminal.
- Use either X7R or X5R dielectric input capacitors. Do not use Y5V or Z5U-type capacitors.
- If a tantalum input capacitor is placed in parallel with the input capacitor, it must be recommended for switching regulator applications and the operating voltage must be derated by 50%.
- In hot-plug applications, a tantalum or electrolytic bypass capacitor must be used to limit the overvoltage spike seen on the input supply when power is suddenly applied.

### 6.3 Inductor

- Keep the inductor connection to the Switch Node (SW) short.
- Do not route any digital lines underneath or close to the inductor.
- Keep the Switch Node (SW) away from the Feedback (FB) pin.

### 6.4 Output Capacitor

- Use a wide trace to connect the output capacitor ground terminal to the input capacitor ground terminal.
- Phase margin will change as the output capacitor value and ESR change. Contact the factory if the output capacitor is different from what is shown in the Bill of Materials (BOM).
- The feedback trace must be separate from the power trace and connected as close as possible to the output capacitor. Sensing a long high-current load trace can degrade the DC load regulation.

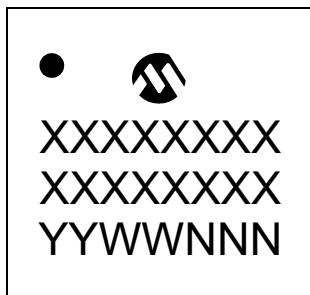
# MIC28516

---

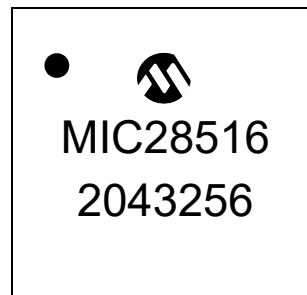
## 7.0 PACKAGING INFORMATION

### 7.1 Package Marking Information

32-Lead VQFN (6x6 mm)



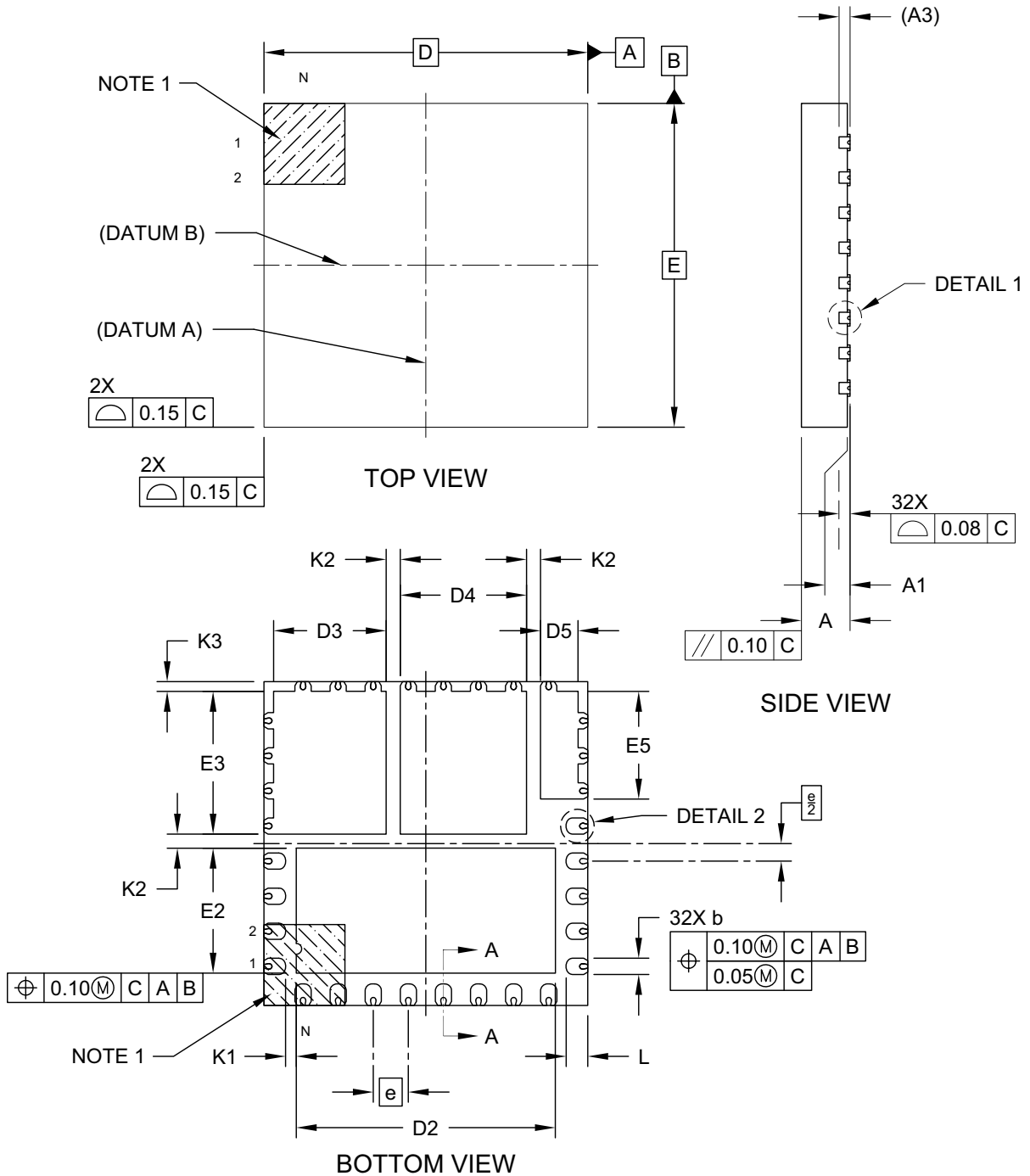
Example



<b>Legend:</b>	XX...X	Customer-specific information
	Y	Year code (last digit of calendar year)
	YY	Year code (last 2 digits of calendar year)
	WW	Week code (week of January 1 is week '01')
	NNN	Alphanumeric traceability code
	(e3)	Pb-free JEDEC designator for Matte Tin (Sn)
	*	This package is Pb-free. The Pb-free JEDEC designator (e3) can be found on the outer packaging for this package.
<b>Note:</b>	In the event the full Microchip part number cannot be marked on one line, it will be carried over to the next line, thus limiting the number of available characters for customer-specific information.	

## 32-Lead Very Thin Plastic Quad Flat, No Lead Package (PHA) - 6x6 mm Body [VQFN] Wettable Flanks, Multiple Exposed Pads

**Note:** For the most current package drawings, please see the Microchip Packaging Specification located at <http://www.microchip.com/packaging>

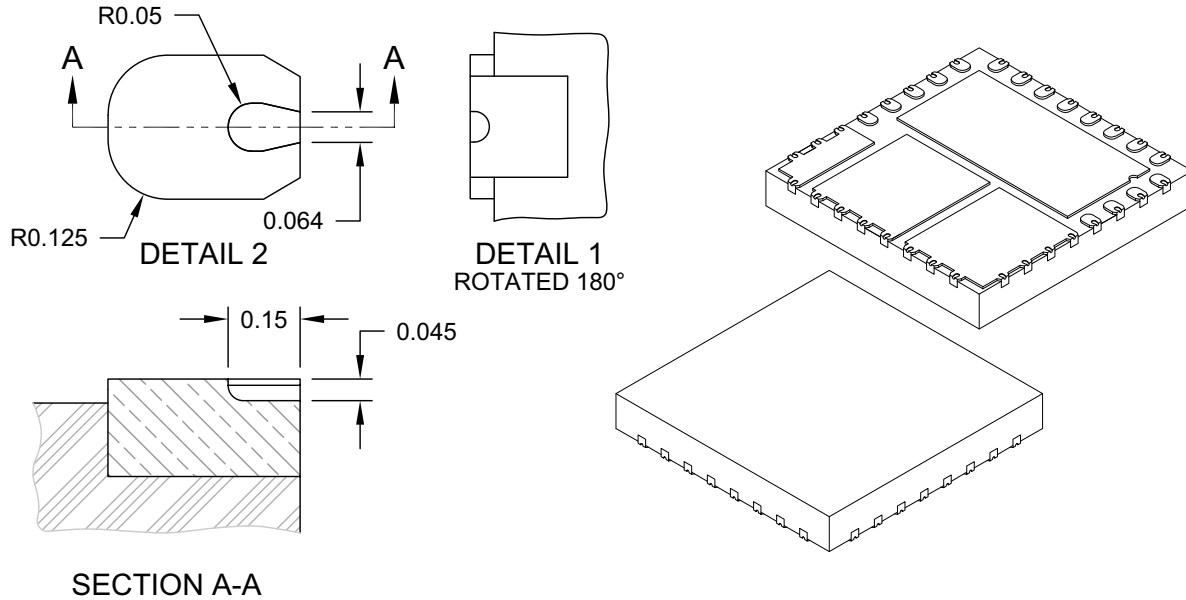


Microchip Technology Drawing C04-1196C Sheet 1 of 2

# MIC28516

## 32-Lead Very Thin Plastic Quad Flat, No Lead Package (PHA) - 6x6 mm Body [VQFN] Wettable Flanks, Multiple Exposed Pads

**Note:** For the most current package drawings, please see the Microchip Packaging Specification located at <http://www.microchip.com/packaging>



Dimension Limits	Units	MILLIMETERS		
		MIN	NOM	MAX
Number of Terminals	N	32		
Pitch	e	0.65 BSC		
Overall Height	A	0.80	0.85	0.90
Standoff	A1	0.00	0.02	0.05
Terminal Thickness	A3	0.203 REF		
Overall Length	D	6.00 BSC		
Overall Width	E	6.00 BSC		
Exposed Pad Length	D2	4.70	4.80	4.90
Exposed Pad Width	E2	2.215	2.315	2.415
Exposed Pad Length	D3	1.985	2.085	2.185
Exposed Pad Width	E3	2.545	2.645	2.745
Exposed Pad Length	D4	2.240	2.340	2.440
Exposed Pad Length	D5	0.595	0.695	0.795
Exposed Pad Width	E5	1.895	1.995	2.095
Terminal Width	b	0.25	0.30	0.35
Terminal Length	L	0.30	0.40	0.50
Terminal-to-Exposed Pad	K1	0.20	-	-
Exposed Pad-to-Exposed Pad	K2	0.20	0.26	-
Package Edge-to-Exposed Pad	K3	0.18	-	-

**Notes:**

- Pin 1 visual index feature may vary, but must be located within the hatched area.
- Package is saw singulated
- Dimensioning and tolerancing per ASME Y14.5M

BSC: Basic Dimension. Theoretically exact value shown without tolerances.

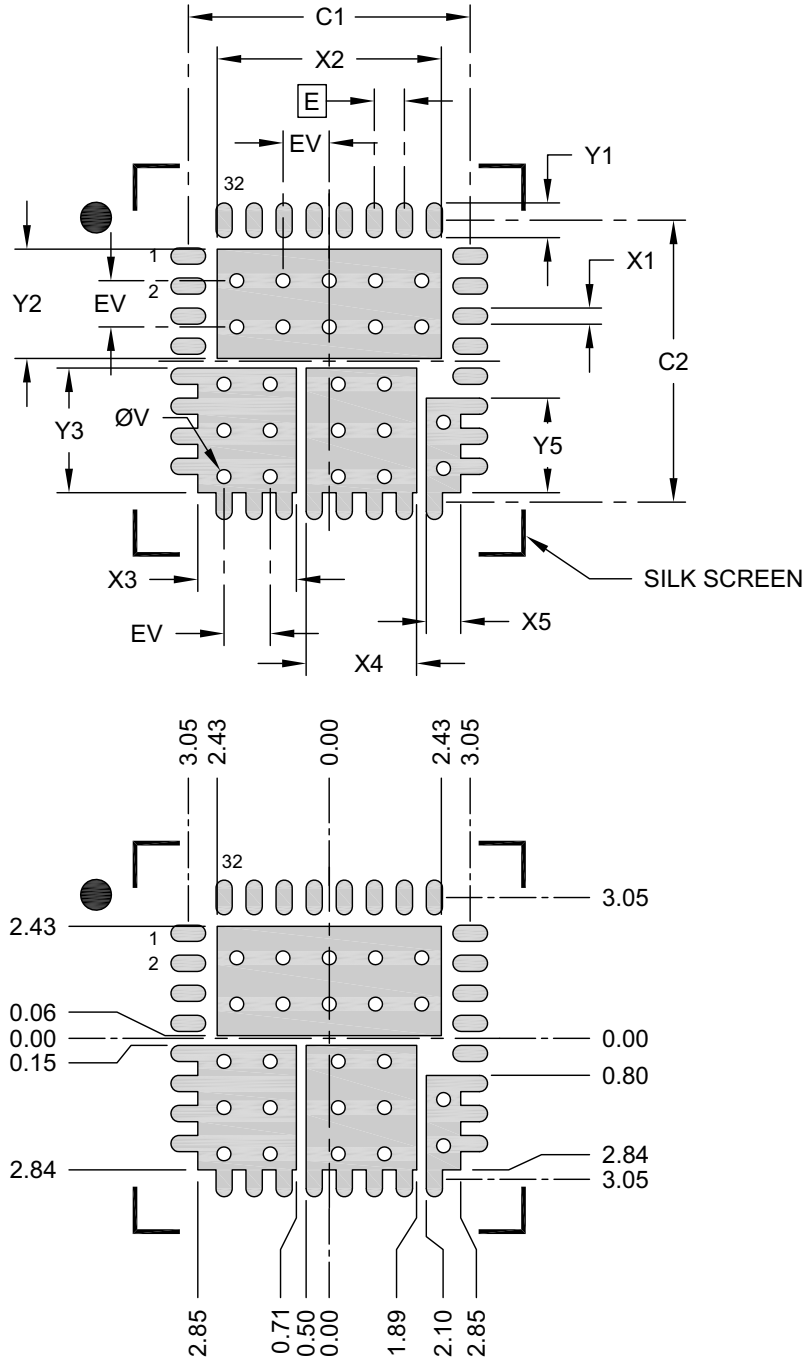
REF: Reference Dimension, usually without tolerance, for information purposes only.

Microchip Technology Drawing C04-1196C Sheet 2 of 2



## 32-Lead Very Thin Plastic Quad Flat, No Lead Package (PHA) - 6x6 mm Body [VQFN] Wettable Flanks, Multiple Exposed Pads

**Note:** For the most current package drawings, please see the Microchip Packaging Specification located at <http://www.microchip.com/packaging>



Microchip Technology Drawing C04-3196 Rev C Sheet 1 of 2

## APPENDIX A: REVISION HISTORY

### Revision C (July 2021)

- Updated the value of  $R_{CL}$  throughout the document.
- Updated [Figures 2-34, 2-35, 2-49, 2-50, 2-51, 2-52](#).
- Updated [Table 3-1](#).

### Revision B (February 2021)

- Updated [Absolute Maximum Ratings†](#).
- Updated [Operating Ratings‡](#).
- Updated [Table 1-2](#).
- Updated [Table 3-1](#).
- Updated [Section 4.3 “Current Limit”](#).
- Updated [Section 4.5 “Internal MOSFET Gate Drive”](#).
- Updated [Equation 5-11](#).
- Updated [Section 5.6 “Output Capacitor Selection”](#).

### Revision A (March 2020)

- Initial release of this document.

## PRODUCT IDENTIFICATION SYSTEM

To order or obtain information, e.g., on pricing or delivery, refer to the factory or the listed sales office.

<u>PART NO.</u>	<u>[X]<sup>(1)</sup></u>	<u>-X</u>	<u>/XXX</u>	<u>XXX</u>	<b>Examples:</b>																														
<b>Device</b>	<b>Tape and Reel Option</b>	<b>Temperature Range</b>	<b>Package</b>	<b>Qualification</b>																															
<table border="1"> <tr> <td><b>Device:</b></td> <td>MIC28516:</td> <td colspan="3">70V/8A Hyper Speed Control<sup>®</sup> Synchronous DC/DC Buck Regulator with External Soft Start</td> </tr> <tr> <td><b>Tape and Reel Option:</b></td> <td>T</td> <td>=</td> <td colspan="2">3300/Reel<sup>(1)</sup></td> </tr> <tr> <td><b>Temperature Range:</b></td> <td>E</td> <td>=</td> <td colspan="2">-40°C to +125°C (Extended)</td> </tr> <tr> <td><b>Package:</b></td> <td>PHA</td> <td>=</td> <td colspan="2">32-Lead, 6 mm x 6 mm VQFN (Very Thin Plastic Quad Flat, No Lead Package, Wettable Flanks, Multiple Exposed Pads)</td> </tr> <tr> <td><b>Qualification:</b></td> <td>(Blank)</td> <td>=</td> <td colspan="2">Standard part</td> </tr> <tr> <td></td> <td>VAO</td> <td>=</td> <td colspan="2">Automotive AEC-Q104 Qualified</td> </tr> </table>					<b>Device:</b>	MIC28516:	70V/8A Hyper Speed Control <sup>®</sup> Synchronous DC/DC Buck Regulator with External Soft Start			<b>Tape and Reel Option:</b>	T	=	3300/Reel <sup>(1)</sup>		<b>Temperature Range:</b>	E	=	-40°C to +125°C (Extended)		<b>Package:</b>	PHA	=	32-Lead, 6 mm x 6 mm VQFN (Very Thin Plastic Quad Flat, No Lead Package, Wettable Flanks, Multiple Exposed Pads)		<b>Qualification:</b>	(Blank)	=	Standard part			VAO	=	Automotive AEC-Q104 Qualified		<p>a) MIC28516T-E/PHA: 70V/8A Hyper Speed Control<sup>®</sup> Synchronous DC/DC Buck Regulator, with External Soft Start, -40°C to +125°C Temperature Range, 32-Lead VQFN package, 3300/Reel</p> <p>b) MIC28516T-E/PHAVAO: 70V/8A Hyper Speed Control<sup>®</sup> Synchronous DC/DC Buck Regulator, with External Soft Start, -40°C to +125°C Extended Temp. Range, 32-Lead VQFN package, 3300/Reel Automotive AEC-Q104 Qualified</p> <p><b>Note 1:</b> Tape and Reel identifier only appears in the catalog part number description. This identifier is used for ordering purposes and is not printed on the device package. Check with your Microchip Sales Office for package availability with the Tape and Reel option.</p>
<b>Device:</b>	MIC28516:	70V/8A Hyper Speed Control <sup>®</sup> Synchronous DC/DC Buck Regulator with External Soft Start																																	
<b>Tape and Reel Option:</b>	T	=	3300/Reel <sup>(1)</sup>																																
<b>Temperature Range:</b>	E	=	-40°C to +125°C (Extended)																																
<b>Package:</b>	PHA	=	32-Lead, 6 mm x 6 mm VQFN (Very Thin Plastic Quad Flat, No Lead Package, Wettable Flanks, Multiple Exposed Pads)																																
<b>Qualification:</b>	(Blank)	=	Standard part																																
	VAO	=	Automotive AEC-Q104 Qualified																																



---

**Note the following details of the code protection feature on Microchip devices:**

- Microchip products meet the specifications contained in their particular Microchip Data Sheet.
- Microchip believes that its family of products is secure when used in the intended manner and under normal conditions.
- There are dishonest and possibly illegal methods being used in attempts to breach the code protection features of the Microchip devices. We believe that these methods require using the Microchip products in a manner outside the operating specifications contained in Microchip's Data Sheets. Attempts to breach these code protection features, most likely, cannot be accomplished without violating Microchip's intellectual property rights.
- Microchip is willing to work with any customer who is concerned about the integrity of its code.
- Neither Microchip nor any other semiconductor manufacturer can guarantee the security of its code. Code protection does not mean that we are guaranteeing the product is "unbreakable". Code protection is constantly evolving. We at Microchip are committed to continuously improving the code protection features of our products. Attempts to break Microchip's code protection feature may be a violation of the Digital Millennium Copyright Act. If such acts allow unauthorized access to your software or other copyrighted work, you may have a right to sue for relief under that Act.

---

Information contained in this publication is provided for the sole purpose of designing with and using Microchip products. Information regarding device applications and the like is provided only for your convenience and may be superseded by updates. It is your responsibility to ensure that your application meets with your specifications.

THIS INFORMATION IS PROVIDED BY MICROCHIP "AS IS". MICROCHIP MAKES NO REPRESENTATIONS OR WARRANTIES OF ANY KIND WHETHER EXPRESS OR IMPLIED, WRITTEN OR ORAL, STATUTORY OR OTHERWISE, RELATED TO THE INFORMATION INCLUDING BUT NOT LIMITED TO ANY IMPLIED WARRANTIES OF NON-INFRINGEMENT, MERCHANTABILITY, AND FITNESS FOR A PARTICULAR PURPOSE OR WARRANTIES RELATED TO ITS CONDITION, QUALITY, OR PERFORMANCE.

IN NO EVENT WILL MICROCHIP BE LIABLE FOR ANY INDIRECT, SPECIAL, PUNITIVE, INCIDENTAL OR CONSEQUENTIAL LOSS, DAMAGE, COST OR EXPENSE OF ANY KIND WHATSOEVER RELATED TO THE INFORMATION OR ITS USE, HOWEVER CAUSED, EVEN IF MICROCHIP HAS BEEN ADVISED OF THE POSSIBILITY OR THE DAMAGES ARE FORESEEABLE. TO THE FULLEST EXTENT ALLOWED BY LAW, MICROCHIP'S TOTAL LIABILITY ON ALL CLAIMS IN ANY WAY RELATED TO THE INFORMATION OR ITS USE WILL NOT EXCEED THE AMOUNT OF FEES, IF ANY, THAT YOU HAVE PAID DIRECTLY TO MICROCHIP FOR THE INFORMATION. Use of Microchip devices in life support and/or safety applications is entirely at the buyer's risk, and the buyer agrees to defend, indemnify and hold harmless Microchip from any and all damages, claims, suits, or expenses resulting from such use. No licenses are conveyed, implicitly or otherwise, under any Microchip intellectual property rights unless otherwise stated.

**Trademarks**

The Microchip name and logo, the Microchip logo, Adaptec, AnyRate, AVR, AVR logo, AVR Freaks, BesTime, BitCloud, chipKIT, chipKIT logo, CryptoMemory, CryptoRF, dsPIC, FlashFlex, flexPWR, HELDO, IGL00, JukeBlox, KeeLoq, Kleer, LANCheck, LinkMD, maXStylus, maXTouch, MediaLB, megaAVR, Microsemi, Microsemi logo, MOST, MOST logo, MPLAB, OptoLyzer, PackeTime, PIC, picoPower, PICSTART, PIC32 logo, PolarFire, Prochip Designer, QTouch, SAM-BA, SenGenuity, SpyNIC, SST, SST Logo, SuperFlash, Symmetricom, SyncServer, Tachyon, TimeSource, tinyAVR, UNI/O, Vectron, and XMEGA are registered trademarks of Microchip Technology Incorporated in the U.S.A. and other countries.

AgileSwitch, APT, ClockWorks, The Embedded Control Solutions Company, EtherSynch, FlashTec, Hyper Speed Control, HyperLight Load, IntelliMOS, Libero, motorBench, mTouch, Powermite 3, Precision Edge, ProASIC, ProASIC Plus, ProASIC Plus logo, Quiet-Wire, SmartFusion, SyncWorld, Temux, TimeCesium, TimeHub, TimePictra, TimeProvider, WinPath, and ZL are registered trademarks of Microchip Technology Incorporated in the U.S.A.

Adjacent Key Suppression, AKS, Analog-for-the-Digital Age, Any Capacitor, AnyIn, AnyOut, Augmented Switching, BlueSky, BodyCom, CodeGuard, CryptoAuthentication, CryptoAutomotive, CryptoCompanion, CryptoController, dsPICDEM, dsPICDEM.net, Dynamic Average Matching, DAM, ECAN, Espresso T1S, EtherGREEN, IdealBridge, In-Circuit Serial Programming, ICSP, INICnet, Intelligent Paralleling, Inter-Chip Connectivity, JitterBlocker, maxCrypto, maxView, memBrain, Mindi, MiWi, MPASM, MPF, MPLAB Certified logo, MPLIB, MPLINK, MultiTRAK, NetDetach, Omniscient Code Generation, PICDEM, PICDEM.net, PICkit, PICtail, PowerSmart, PureSilicon, QMatrix, REAL ICE, Ripple Blocker, RTAX, RTG4, SAM-ICE, Serial Quad I/O, simpleMAP, SimpliPHY, SmartBuffer, SMART-I.S., storClad, SQI, SuperSwitcher, SuperSwitcher II, Switchtec, SynchroPHY, Total Endurance, TSHARC, USBCheck, VariSense, VectorBlox, VeriPHY, ViewSpan, WiperLock, XpressConnect, and ZENA are trademarks of Microchip Technology Incorporated in the U.S.A. and other countries.

SQTP is a service mark of Microchip Technology Incorporated in the U.S.A.

The Adaptec logo, Frequency on Demand, Silicon Storage Technology, and Symmcom are registered trademarks of Microchip Technology Inc. in other countries.

GestIC is a registered trademark of Microchip Technology Germany II GmbH & Co. KG, a subsidiary of Microchip Technology Inc., in other countries.

All other trademarks mentioned herein are property of their respective companies.

© 2020-2021, Microchip Technology Incorporated, All Rights Reserved.

ISBN: 978-1-5224-8466-0

For information regarding Microchip's Quality Management Systems, please visit [www.microchip.com/quality](http://www.microchip.com/quality).



# MICROCHIP

## Worldwide Sales and Service

### AMERICAS

**Corporate Office**  
2355 West Chandler Blvd.  
Chandler, AZ 85224-6199  
Tel: 480-792-7200  
Fax: 480-792-7277  
Technical Support:  
<http://www.microchip.com/support>  
Web Address:  
[www.microchip.com](http://www.microchip.com)

**Atlanta**  
Duluth, GA  
Tel: 678-957-9614  
Fax: 678-957-1455

**Austin, TX**  
Tel: 512-257-3370

**Boston**  
Westborough, MA  
Tel: 774-760-0087  
Fax: 774-760-0088

**Chicago**  
Itasca, IL  
Tel: 630-285-0071  
Fax: 630-285-0075

**Dallas**  
Addison, TX  
Tel: 972-818-7423  
Fax: 972-818-2924

**Detroit**  
Novi, MI  
Tel: 248-848-4000

**Houston, TX**  
Tel: 281-894-5983

**Indianapolis**  
Noblesville, IN  
Tel: 317-773-8323  
Fax: 317-773-5453  
Tel: 317-536-2380

**Los Angeles**  
Mission Viejo, CA  
Tel: 949-462-9523  
Fax: 949-462-9608  
Tel: 951-273-7800

**Raleigh, NC**  
Tel: 919-844-7510

**New York, NY**  
Tel: 631-435-6000

**San Jose, CA**  
Tel: 408-735-9110  
Tel: 408-436-4270

**Canada - Toronto**  
Tel: 905-695-1980  
Fax: 905-695-2078

### ASIA/PACIFIC

**Australia - Sydney**  
Tel: 61-2-9868-6733

**China - Beijing**  
Tel: 86-10-8569-7000

**China - Chengdu**  
Tel: 86-28-8665-5511

**China - Chongqing**  
Tel: 86-23-8980-9588

**China - Dongguan**  
Tel: 86-769-8702-9880

**China - Guangzhou**  
Tel: 86-20-8755-8029

**China - Hangzhou**  
Tel: 86-571-8792-8115

**China - Hong Kong SAR**  
Tel: 852-2943-5100

**China - Nanjing**  
Tel: 86-25-8473-2460

**China - Qingdao**  
Tel: 86-532-8502-7355

**China - Shanghai**  
Tel: 86-21-3326-8000

**China - Shenyang**  
Tel: 86-24-2334-2829

**China - Shenzhen**  
Tel: 86-755-8864-2200

**China - Suzhou**  
Tel: 86-186-6233-1526

**China - Wuhan**  
Tel: 86-27-5980-5300

**China - Xian**  
Tel: 86-29-8833-7252

**China - Xiamen**  
Tel: 86-592-2388138

**China - Zhuhai**  
Tel: 86-756-3210040

### ASIA/PACIFIC

**India - Bangalore**  
Tel: 91-80-3090-4444

**India - New Delhi**  
Tel: 91-11-4160-8631

**India - Pune**  
Tel: 91-20-4121-0141

**Japan - Osaka**  
Tel: 81-6-6152-7160

**Japan - Tokyo**  
Tel: 81-3-6880-3770

**Korea - Daegu**  
Tel: 82-53-744-4301

**Korea - Seoul**  
Tel: 82-2-554-7200

**Malaysia - Kuala Lumpur**  
Tel: 60-3-7651-7906

**Malaysia - Penang**  
Tel: 60-4-227-8870

**Philippines - Manila**  
Tel: 63-2-634-9065

**Singapore**  
Tel: 65-6334-8870

**Taiwan - Hsin Chu**  
Tel: 886-3-577-8366

**Taiwan - Kaohsiung**  
Tel: 886-7-213-7830

**Taiwan - Taipei**  
Tel: 886-2-2508-8600

**Thailand - Bangkok**  
Tel: 66-2-694-1351

**Vietnam - Ho Chi Minh**  
Tel: 84-28-5448-2100

### EUROPE

**Austria - Wels**  
Tel: 43-7242-2244-39  
Fax: 43-7242-2244-393

**Denmark - Copenhagen**  
Tel: 45-4485-5910  
Fax: 45-4485-2829

**Finland - Espoo**  
Tel: 358-9-4520-820

**France - Paris**  
Tel: 33-1-69-53-63-20  
Fax: 33-1-69-30-90-79

**Germany - Garching**  
Tel: 49-8931-9700

**Germany - Haan**  
Tel: 49-2129-3766400

**Germany - Heilbronn**  
Tel: 49-7131-72400

**Germany - Karlsruhe**  
Tel: 49-721-625370

**Germany - Munich**  
Tel: 49-89-627-144-0  
Fax: 49-89-627-144-44

**Germany - Rosenheim**  
Tel: 49-8031-354-560

**Israel - Ra'anana**  
Tel: 972-9-744-7705

**Italy - Milan**  
Tel: 39-0331-742611  
Fax: 39-0331-466781

**Italy - Padova**  
Tel: 39-049-7625286

**Netherlands - Drunen**  
Tel: 31-416-690399  
Fax: 31-416-690340

**Norway - Trondheim**  
Tel: 47-7288-4388

**Poland - Warsaw**  
Tel: 48-22-3325737

**Romania - Bucharest**  
Tel: 40-21-407-87-50

**Spain - Madrid**  
Tel: 34-91-708-08-90  
Fax: 34-91-708-08-91

**Sweden - Gothenberg**  
Tel: 46-31-704-60-40

**Sweden - Stockholm**  
Tel: 46-8-5090-4654

**UK - Wokingham**  
Tel: 44-118-921-5800  
Fax: 44-118-921-5820

# Mouser Electronics

Authorized Distributor

Click to View Pricing, Inventory, Delivery & Lifecycle Information:

[Microchip:](#)

[MIC28516T-E/PHA](#) [MIC28516T-E/PHAVAO](#)