

Thermofit Molded Parts Specification Control Drawing

Part Number : 222D121 thru 196
Description : Boot, 90°, With Lip

NOTES

- All dimensions are in $\frac{\text{inches}}{\text{[millimeters]}}$
- Dimensions appearing in table are as follows:
 - a - As Supplied
 - b - After Unrestricted Recovery
- Coating is optional. As supplied dimensions appearing in table are for uncoated parts. When coating is added, entry diameters will be reduced by .06 max.
- Molding ports are optional. When -00 modification number is specified molding ports will be located as shown.
- * -8 material is not available on 222D185 and 222D196.

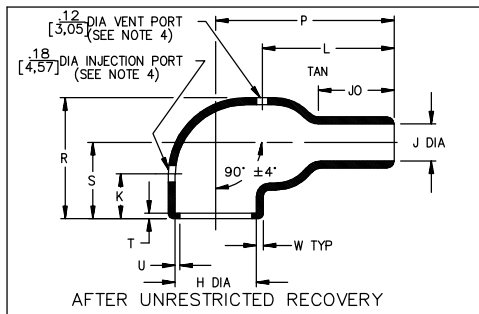

TABLE OF DIMENSIONS

PART NUMBER	H			J				P ±10% b	R Ref b	S Ref b	T Ref b	U Ref b	JO ±10% b	W ±20% b	K ±10% b	L ±10% b
	Min -8,-100 a	Min a	Max b	Min -8,-100 a	Min 3,-4,-25 a	Min -5,-6,-12 a	Max b									
222D121	.94 [24,0]	.92 [23,4]	.41 [10,4]	.55 [14,0]	.92 [23,4]	.49 [12,4]	.22 [5,6]	.84 [21,3]	.89 [22,6]	.65 [16,5]	.12 [3,0]	.04 [1,0]	.23 [5,8]	.05 [1,3]	.60 [15,2]	.58 [14,7]
222D132	1.18 [30,0]	1.12 [28,4]	.56 [14,2]	.59 [15,0]	1.12 [28,4]	.58 [14,7]	.26 [6,6]	1.33 [33,8]	1.07 [27,2]	.76 [19,3]	.12 [3,0]	.04 [1,0]	.65 [15,5]	.06 [1,5]	.75 [19,1]	.98 [24,9]
222D142	1.22 [31,0]	1.22 [31,0]	.70 [17,8]	.71 [18,0]	1.22 [31,0]	.63 [16,0]	.28 [7,1]	1.44 [36,6]	1.22 [31,0]	.83 [21,1]	.12 [3,0]	.04 [1,0]	.50 [12,7]	.07 [1,8]	.75 [19,1]	.98 [24,9]
222D152	1.42 [36,0]	1.42 [36,0]	.88 [22,4]	.83 [21,0]	1.42 [36,0]	.73 [18,5]	.33 [8,4]	1.72 [43,7]	1.38 [35,1]	.90 [22,9]	.12 [3,0]	.04 [1,0]	.57 [14,5]	.07 [1,8]	.75 [19,1]	1.18 [30,0]
222D163	1.69 [43,0]	1.68 [42,7]	1.11 [28,2]	.98 [25,0]	1.68 [42,7]	.87 [22,1]	.39 [9,9]	2.11 [53,6]	1.73 [43,9]	1.14 [29,0]	.12 [3,0]	.07 [1,7]	.69 [17,5]	.08 [2,0]	.76 [19,3]	1.30 [33,0]
222D174	2.05 [52,0]	2.04 [51,8]	1.38 [35,1]	1.54 [39,0]	2.04 [51,8]	1.39 [35,3]	.62 [15,7]	3.07 [78,0]	2.08 [52,8]	1.32 [33,5]	.12 [3,0]	.07 [1,7]	1.32 [33,5]	.13 [3,3]	1.00 [25,4]	2.12 [53,8]
* 222D185	2.60 [66,0]	2.60 [66,0]	1.75 [44,5]	1.65 [42,0]	2.60 [66,0]	1.80 [45,7]	.80 [20,3]	3.84 [97,5]	2.60 [66,0]	1.64 [41,7]	.12 [3,0]	.08 [2,0]	1.58 [40,1]	.15 [3,8]	1.00 [25,4]	2.80 [71,1]
* 222D196	3.22 [81,8]	3.22 [81,8]	2.38 [60,5]	2.25 [57,2]	3.22 [81,8]	2.25 [57,2]	1.00 [25,4]	4.64 [117,9]	3.30 [83,8]	2.03 [51,6]	.12 [3,0]	.08 [2,0]	1.50 [38,1]	.16 [4,1]	1.00 [25,4]	3.15 [80,0]

IF THIS DOCUMENT IS PRINTED IT BECOMES UNCONTROLLED. CHECK FOR THE LATEST REVISION.

STE TE Connectivity
300 Constitution Drive,
Menlo Park, CA 94025

Revision : R1
Date : 20APR11

Part Number : 222D121 thru 196
Description : Boot, 90°, With Lip

Thermofit Molded Parts Specification Control Drawing

Part Number : 222D121 thru 196
Description : Boot, 90°, With Lip

COMPATABILITY CHART

MATERIAL DASH NO.	MATERIAL DESCRIPTION	RT SPEC	COATING SLASH NO.	COATING S NO.	COATING DESCRIPTION
-3	Polyolefin, Semi-rigid	RT-301	/42;/86;/180	S-1017;S-1048;S-1030	Adhesive
-4	Polyolefin, Flexible	RT-1304	/42;/86;/180	S-1017;S-1048;S-1030	Adhesive
-5	Elastomer, Flexible	RT-501	N/A		
-6	Silicone	RT-602	N/A		
-8	Polyolefin, Space	RT-1308	N/A		
-12	*VITON, Flexible	RT-1312	N/A		
-25	Elastomer, Fluid Resistant	RT-1325	/86;/225	S-1048;S-1206	Adhesive
-100	Polyolefin, Semi-flexible ZEROHAL™	RT-1323	/86;/180;/184	S-1048;S-1030	Adhesive

*VITON is a Registered Trademark of Dupont

ORDERING INFORMATION

222D1XX -X -XX /XXX

Base part number _____
Material dash number _____
(See Compatability Chart)
Modification number _____
(If necessary, see front of scd binder for a complete list)
Adhesive slash number _____
(If necessary, see Compatability Chart)

THIS DRAWING IS SUBJECT TO CHANGE WITHOUT NOTICE; CONSULT YOUR NEAREST FIELD REPRESENTATIVE FOR CURRENT REVISION

IF THIS DOCUMENT IS PRINTED IT BECOMES UNCONTROLLED. CHECK FOR THE LATEST REVISION.

STE TE Connectivity
300 Constitution Drive,
Menlo Park, CA 94025
IF THIS DOCUMENT IS PRINTED IT BECOMES UNCONTROLLED. CHECK FOR THE LATEST REVISION.

Revision : R1
Date : 20APR11

Part Number : 222D121 thru 196
Description : Boot, 90°, With Lip

CAD FILE MP00112

Mouser Electronics

Authorized Distributor

Click to View Pricing, Inventory, Delivery & Lifecycle Information:

[TE Connectivity:](#)

[222D132-3/42-0](#)