

Features

Unregulated Converters

- Power sharing
- High isolation 3kVDC & 4kVDC for 1 second
- Efficiency up to 87%
- Wide operating temperature range from -40°C to +85°C
- UL60950 certified
- IEC/EN60950-1 certified



RKZ-xx2005D

2 Watt
SIP7 for
SIC Application



Description

The RKZ-xx2005D series features DC/DC converters which are especially designed for SiC mosfet drivers. The modules are available with input voltages of 5, 12, 15, or 24VDC with two asymmetric outputs of +20VDC and -5VDC. A special feature of this converter is output power sharing: the RKZ-xx2005D can be used with equal power (asymmetrical current) or equal current (asymmetrical power) loads. The modules offer 3kVDC or 4kVDC isolation. The operating temperature range of -40C to +100°C (with derating) meets harsh environmental requirements.

Selection Guide

Part Number	nom. Input Voltage (VDC)	Output Voltage (VDC)	Output Current (mA)	Efficiency typ. (%)	max. Capacitive Load ⁽¹⁾ (µF)
RKZ-052005D	5	20/-5	50/-200 +/-80	86 85	100/1500
RKZ-122005D	12	20/-5	50/-200 +/-80	86	100/1500
RKZ-152005D	15	20/-5	50/-200 +/-80	86	100/1500
RKZ-242005D	24	20/-5	50/-200 +/-80	87	100/1500

Notes:

Note1: Max. capacitive load is tested at nominal input voltage and full load

Model Numbering

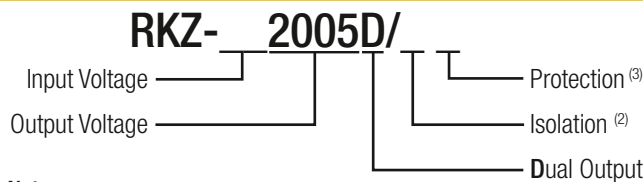

Notes:

- Note2: without suffix, standard 3kVDC isolation
add suffix "/H" for higher 4kVDC isolation
- Note3: without suffix, without Short Circuit Protection
add suffix "/P" for continuous short circuit protection

Examples:

- RKZ-052005D = 5Vin, 20/-5Vout, without SCP function + standard 3kVDC isolation
- RKZ-12005D/HP = 12Vin, 20/-5Vout, with continuous SCP function + high 4kVDC isolation

Specifications (measured @ Ta= 25°C, nom. Vin, full load and after warm-up unless otherwise stated)

BASIC CHARACTERISTICS				
Parameter	Condition	Min.	Typ.	Max.
Input Voltage Range			±10%	
Internal Operating Frequency		20kHz		
Minimum Load			0%	
Output Ripple and Noise ⁽⁴⁾			70mVp-p	150mVp-p

Notes:
Note4: Ripple and Noise is measured with a 20MHz bandwidth and a 0.1µF ceramic capacitor

continued on next page



www.recom-power.com/eval-ref-boards

Specifications (measured @ Ta= 25°C, nom. Vin, full load and after warm-up unless otherwise stated)

Efficiency vs. Load

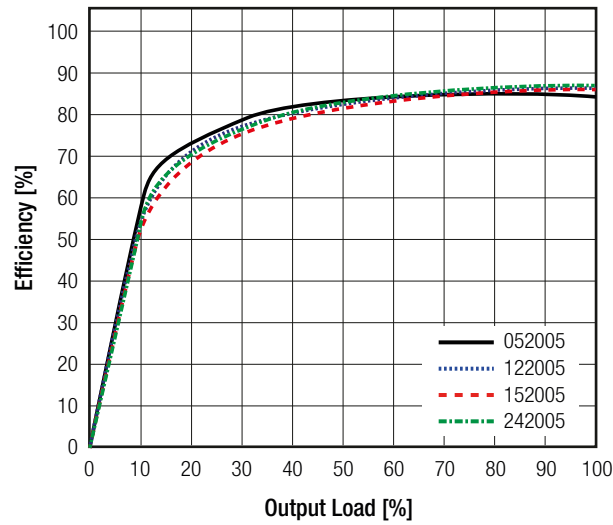

REGULATIONS

Parameter	Condition	Values
Output Accuracy		±5.0% max.
Line Regulation	low line to high line, full load	±1.2% of 1.0% Vin typ.
Load Regulation	10% to 100% load	±5.0% typ. / ±10% max.

Tolerance Envelope

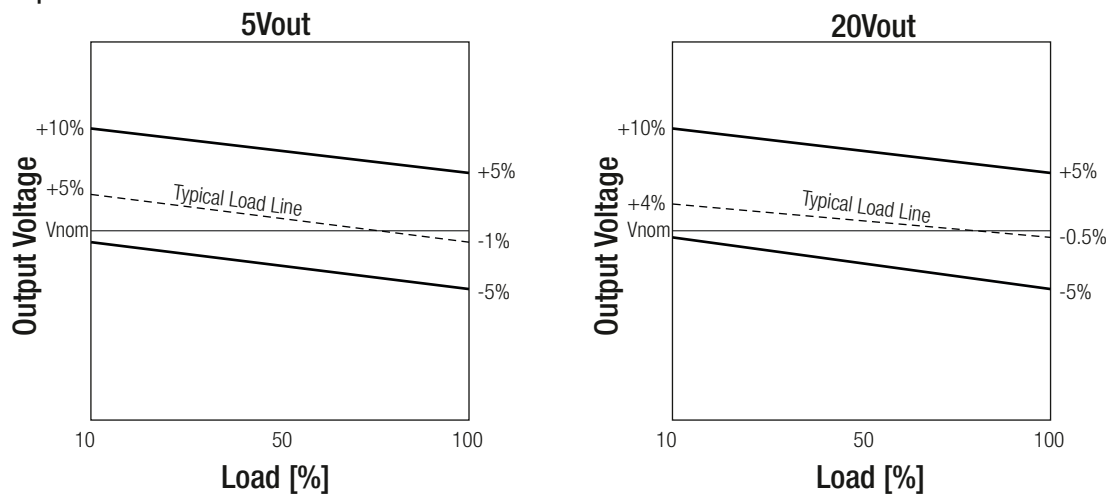

PROTECTIONS

Parameter	Condition			Value
Short Circuit Protection (SCP)	only with "/P" suffix			continuous, automatic recovery
Isolation Voltage ⁽⁵⁾	I/P to O/P	tested for 1 second	without suffix with suffix "/H"	3kVDC / 1 second 4kVDC / 1 second
Isolation Capacitance				135pF max.
Isolation Resistance				10GΩ min.

Notes:

Note5: For repeat Hi-Pot testing, reduce the time and/or the test voltage

Note6: An input fuse is required if the mains supply is not over-current protected. Recommended fuse: T2A slow blow type

Specifications (measured @ Ta= 25°C, nom. Vin, full load and after warm-up unless otherwise stated)

ENVIRONMENTAL

Parameter	Condition		Value
Operating Temperature Range	with derating @ free air convection (see graph)		-40°C to +100°C
Operating Humidity	non-condensing		5% - 95% RH max.
Vibration			MIL-STD-202G
MTBF	according to MIL-HDBK-217F	+25°C +85°C	1800 x 10 ³ hours 560 x 10 ³ hours

Derating Graph

(@ nominal Vin at chamber and free air convection)

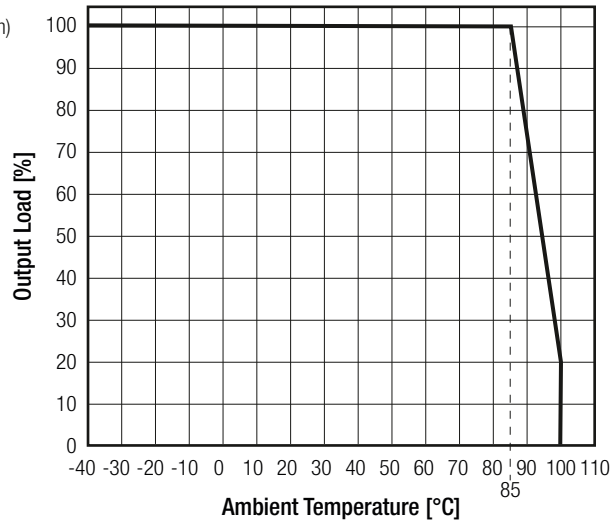

SAFETY AND CERTIFICATIONS

Certificate Type (Safety)	Report / File Number	Standard
Information Technology Equipment, General Requirements for Safety	1602031	EN60950-1:2006 + A2:2013 IEC60950-1:2005; 2nd Edition + A2:2013
Information Technology Equipment, General Requirements for Safety	E358085	UL60950-1, 2nd Edition, 2007 CAN/CSA C22.2 No. 60950-1-07, 2nd Edition, 2006
Medical Electric Equipment, General Requirements for Safety and Essential Performance	MDD1205098-4	IEC60601-1, 3rd Edition, 2005 EN60601-1, 1st Edition, 2006
EAC	RU-AT.49.09571	TP TC 004/2011
RoHS 2+		RoHS-2011/65/EU + AM-2015/863

EMI Compliance

EMI Compliance	Condition	Standard / Criterion
Electromagnetic compatibility of multimedia equipment - Emission requirements	with external filter	EN55032, Class B

EMC filter suggestion for EN55032 Class B

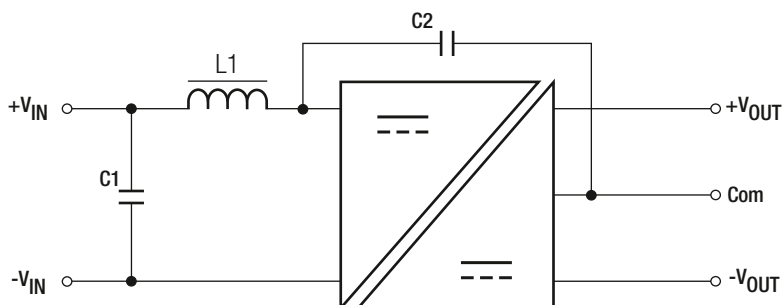

MODEL	C1	C2	L1
RKZ-052005D	10µF	470pF, 4kVDC	4.7µH
RKZ-122005D	4.7µF		22µH
RKZ-152005D	4.7µF		22µH
RKZ-242005D	2.2µF		47µH

Specifications (measured @ Ta= 25°C, nom. Vin, full load and after warm-up unless otherwise stated)

DIMENSION and PHYSICAL CHARACTERISTICS

Parameter	Type	Value
Material	case potting	non-conductive black plastic, (UL94 V-0) epoxy, (UL94 V-0)
Package Dimension (LxWxH)		19.65 x 7.05 x 10.2mm
Package Weight		2.8g

Dimension Drawing (mm)

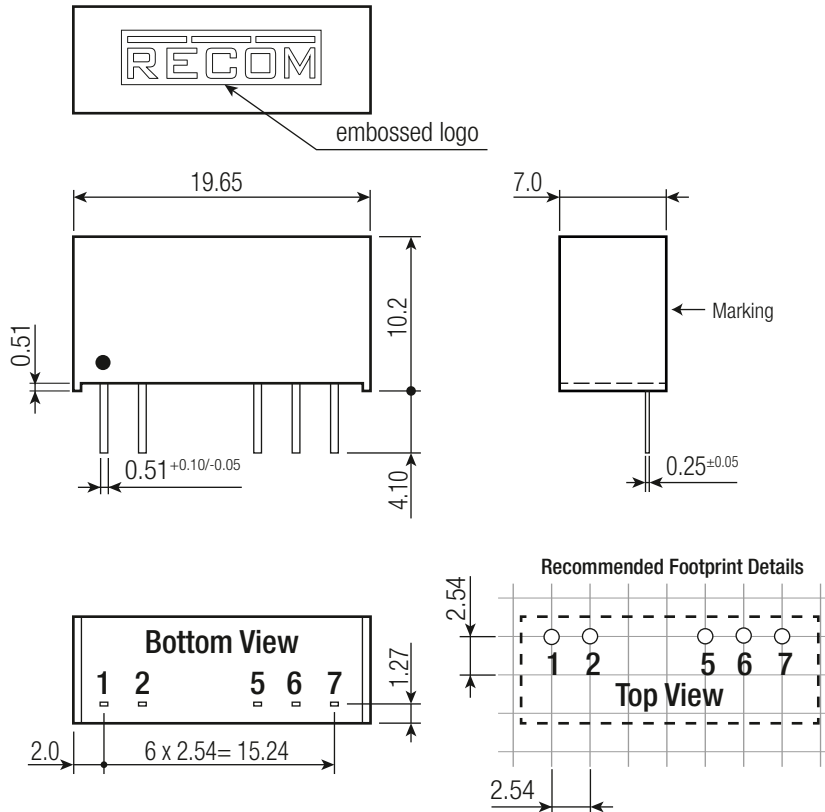

Pin Connections

Pin #	Dual
1	+Vin
2	-Vin
5	-Vout
6	Com
7	+Vout

Tolerance: xx.x= ±0.5mm
xx.xx= ±0.35mm

INSTALLATION AND APPLICATION

Typical Application Circuit

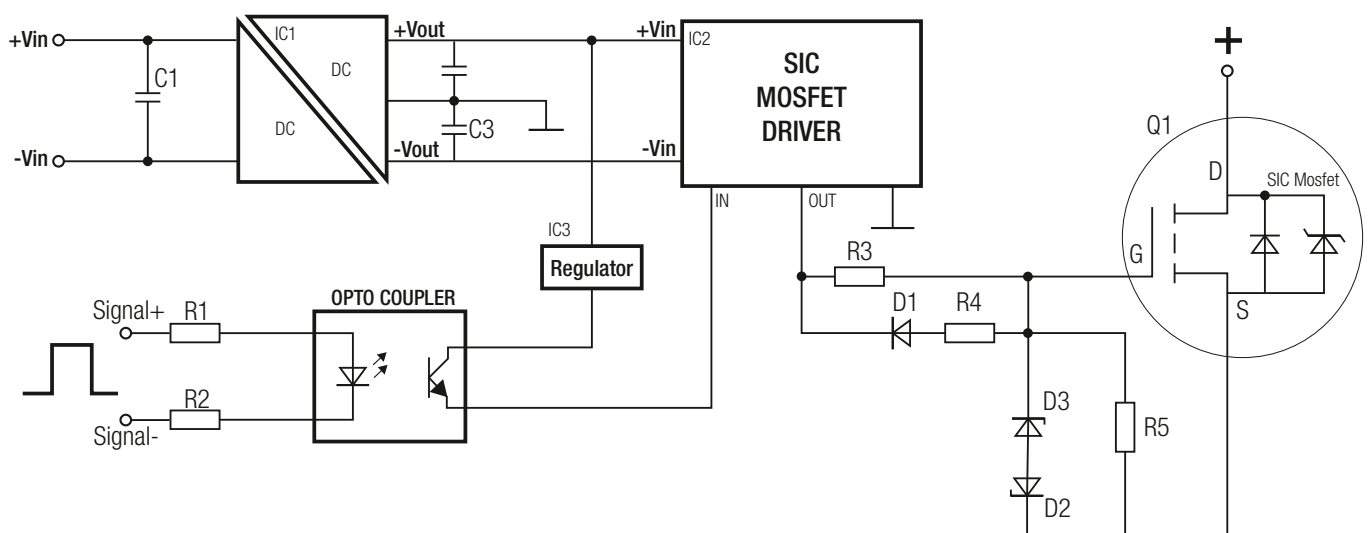

Specifications (measured @ Ta= 25°C, nom. Vin, full load and after warm-up unless otherwise stated)

PACKAGING INFORMATION		
Packaging Dimension (LxWxH)	tube	520.0 x 16.5 x 9.3mm
Packaging Quantity		25pcs
Storage Temperature Range		-55°C to +125°C
Storage Humidity		5% to 95% RH

The product information and specifications may be subject to changes even without prior written notice. The product has been designed for various applications; its suitability lies in the responsibility of each customer. The products are not authorized for use in safety-critical applications without RECOM's explicit written consent. A safety-critical application is an application where a failure may reasonably be expected to endanger or cause loss of life, inflict bodily harm or damage property. The applicant shall indemnify and hold harmless RECOM, its affiliated companies and its representatives against any damage claims in connection with the unauthorized use of RECOM products in such safety-critical applications.

Mouser Electronics

Authorized Distributor

Click to View Pricing, Inventory, Delivery & Lifecycle Information:

RECOM:

[RKZ-152005D](#) [RKZ-242005D/H](#) [RKZ-052005D](#) [RKZ-242005D/P](#) [RKZ-052005D/HP](#) [RKZ-052005D/H](#) [RKZ-122005D/H](#) [RKZ-122005D/HP](#) [RKZ-122005D](#) [RKZ-152005D/H](#) [RKZ-052005D/P](#) [RKZ-152005D/HP](#) [RKZ-152005D/P](#)
[RKZ-242005D/HP](#) [RKZ-242005D](#) [RKZ-122005D/P](#)