

Applications

- High Frequency DC-DC Converters with Synchronous Rectification
- Lead-Free

HEXFET® Power MOSFET

V_{DSS}	$R_{DS(on) \max}$	I_D
40V	13mΩ	10A

Benefits

- Ultra-Low Gate Impedance
- Very Low $R_{DS(on)}$ at 4.5V V_{GS}
- Fully Characterized Avalanche Voltage and Current

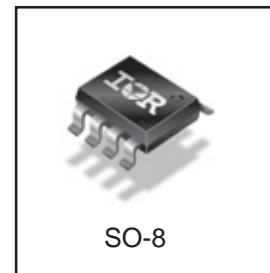
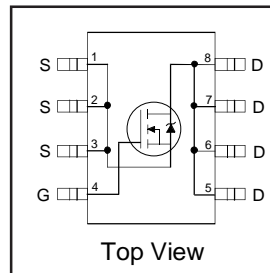

Absolute Maximum Ratings

Symbol	Parameter	Max.	Units
V_{DS}	Drain-Source Voltage	40	V
V_{GS}	Gate-to-Source Voltage	± 12	V
$I_D @ T_A = 25^\circ\text{C}$	Continuous Drain Current, $V_{GS} @ 10\text{V}$	10	A
$I_D @ T_A = 70^\circ\text{C}$	Continuous Drain Current, $V_{GS} @ 10\text{V}$	8.5	
I_{DM}	Pulsed Drain Current ^①	85	
$P_D @ T_A = 25^\circ\text{C}$	Maximum Power Dissipation ^③	2.5	W
$P_D @ T_A = 70^\circ\text{C}$	Maximum Power Dissipation ^③	1.6	W
	Linear Derating Factor	0.02	W/°C
T_J, T_{STG}	Junction and Storage Temperature Range	-55 to + 150	°C

Thermal Resistance

Symbol	Parameter	Typ.	Max.	Units
$R_{\theta JL}$	Junction-to-Drain Lead	—	20	°C/W
$R_{\theta JA}$	Junction-to-Ambient ^④	—	50	

Notes ^① through ^④ are on page 8
www.irf.com

IRF7470PbF

International
IR Rectifier

Static @ T_J = 25°C (unless otherwise specified)

	Parameter	Min.	Typ.	Max.	Units	Conditions
V _{(BR)DSS}	Drain-to-Source Breakdown Voltage	40	—	—	V	V _{GS} = 0V, I _D = 250μA
ΔV _{(BR)DSS} /ΔT _J	Breakdown Voltage Temp. Coefficient	—	0.04	—	V/°C	Reference to 25°C, I _D = 1mA
R _{DS(on)}	Static Drain-to-Source On-Resistance	—	9.0	13	mΩ	V _{GS} = 10V, I _D = 10A ④
		—	10	15		V _{GS} = 4.5V, I _D = 8.0A ④
		—	14.5	30		V _{GS} = 2.8V, I _D = 5.0A ④
V _{GS(th)}	Gate Threshold Voltage	0.8	—	2.0	V	V _{DS} = V _{GS} , I _D = 250μA
I _{DSS}	Drain-to-Source Leakage Current	—	—	20	μA	V _{DS} = 32V, V _{GS} = 0V
		—	—	100		V _{DS} = 32V, V _{GS} = 0V, T _J = 125°C
I _{GSS}	Gate-to-Source Forward Leakage	—	—	200	nA	V _{GS} = 12V
	Gate-to-Source Reverse Leakage	—	—	-200		V _{GS} = -12V

Dynamic @ T_J = 25°C (unless otherwise specified)

Symbol	Parameter	Min.	Typ.	Max.	Units	Conditions
g _{fs}	Forward Transconductance	27	—	—	S	V _{DS} = 20V, I _D = 8.0A
Q _g	Total Gate Charge	—	29	44	nC	I _D = 8.0A
Q _{gs}	Gate-to-Source Charge	—	7.9	12		V _{DS} = 20V
Q _{gd}	Gate-to-Drain ("Miller") Charge	—	8.0	12		V _{GS} = 4.5V ③
Q _{oss}	Output Gate Charge	—	23	35		V _{GS} = 0V, V _{DS} = 16V
t _{d(on)}	Turn-On Delay Time	—	10	—	ns	V _{DD} = 20V
t _r	Rise Time	—	1.9	—		I _D = 8.0A
t _{d(off)}	Turn-Off Delay Time	—	21	—		R _G = 1.8Ω
t _f	Fall Time	—	3.2	—		V _{GS} = 4.5V ③
C _{iss}	Input Capacitance	—	3430	—		pF
C _{oss}	Output Capacitance	—	690	—	V _{DS} = 20V	
C _{rss}	Reverse Transfer Capacitance	—	41	—	f = 1.0MHz	

Avalanche Characteristics

Symbol	Parameter	Typ.	Max.	Units
E _{AS}	Single Pulse Avalanche Energy②	—	300	mJ
I _{AR}	Avalanche Current①	—	8.0	A

Diode Characteristics

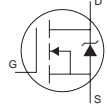
Symbol	Parameter	Min.	Typ.	Max.	Units	Conditions
I _S	Continuous Source Current (Body Diode)	—	—	2.3	A	MOSFET symbol showing the integral reverse p-n junction diode. 
I _{SM}	Pulsed Source Current (Body Diode) ①	—	—	85		
V _{SD}	Diode Forward Voltage	—	0.80	1.3	V	T _J = 25°C, I _S = 8.0A, V _{GS} = 0V ③
		—	0.65	—		T _J = 125°C, I _S = 8.0A, V _{GS} = 0V
t _{rr}	Reverse Recovery Time	—	72	110	ns	T _J = 25°C, I _F = 8.0A, V _R = 20V
Q _{rr}	Reverse Recovery Charge	—	130	200	nC	di/dt = 100A/μs ③
t _{rr}	Reverse Recovery Time	—	76	110	ns	T _J = 125°C, I _F = 8.0A, V _R = 20V
Q _{rr}	Reverse Recovery Charge	—	150	230	nC	di/dt = 100A/μs ③

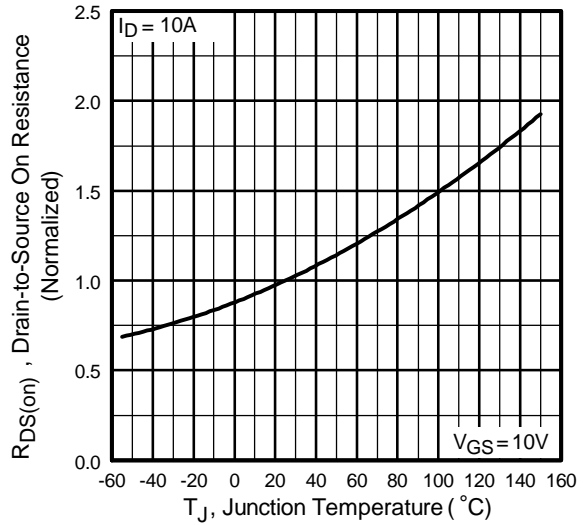
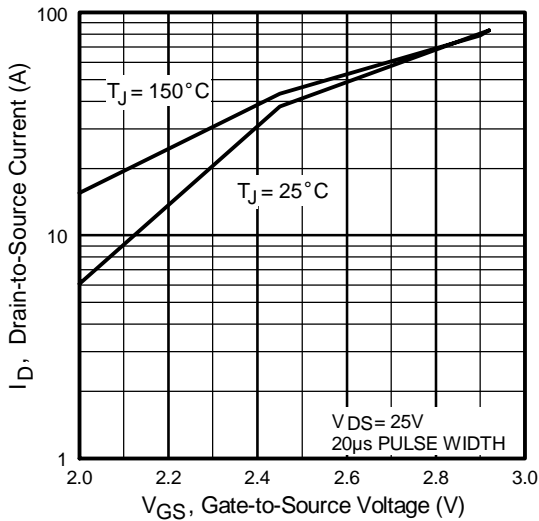
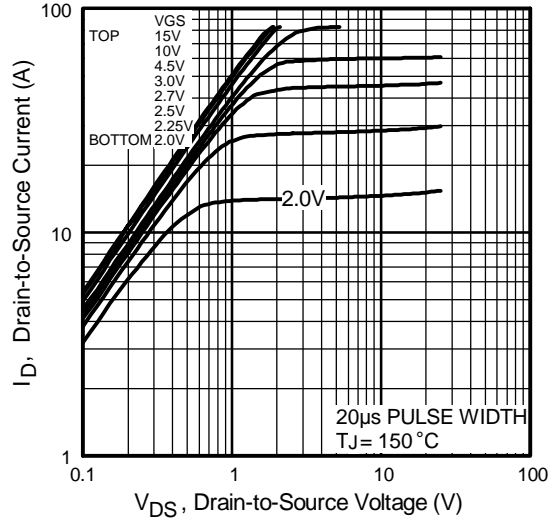
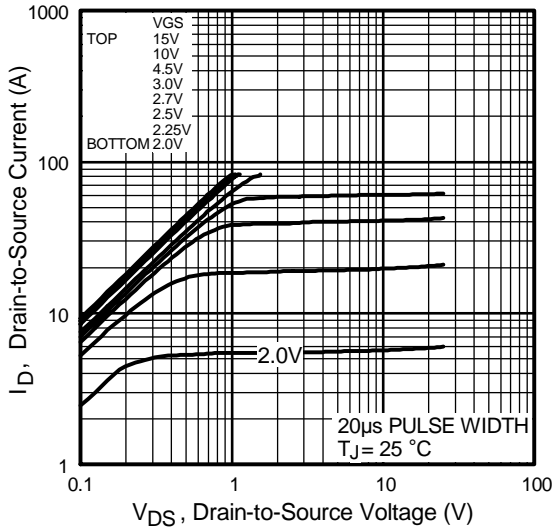

IRF7470PbF

International
IR Rectifier

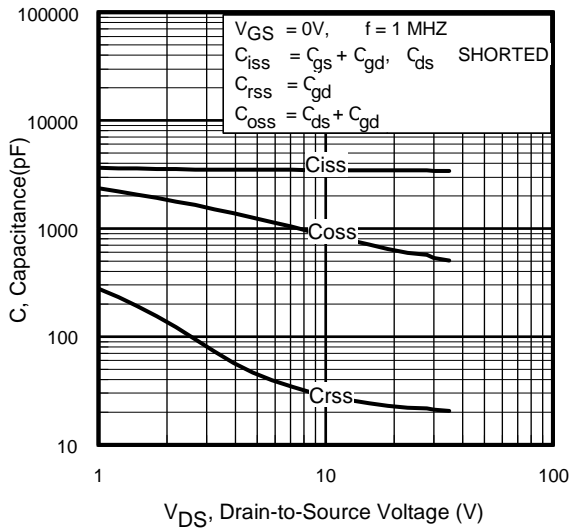

Fig 5. Typical Capacitance Vs. Drain-to-Source Voltage

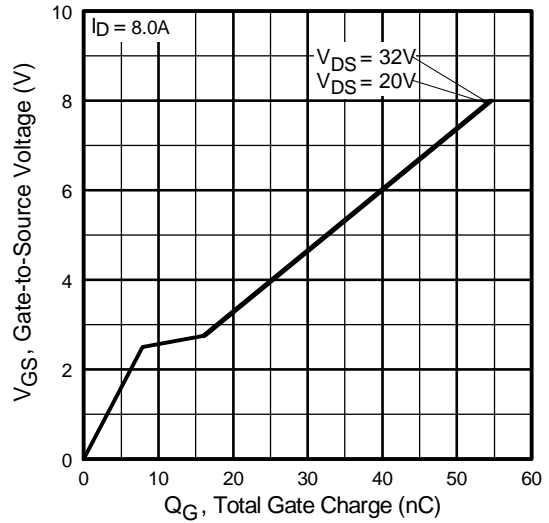

Fig 6. Typical Gate Charge Vs. Gate-to-Source Voltage

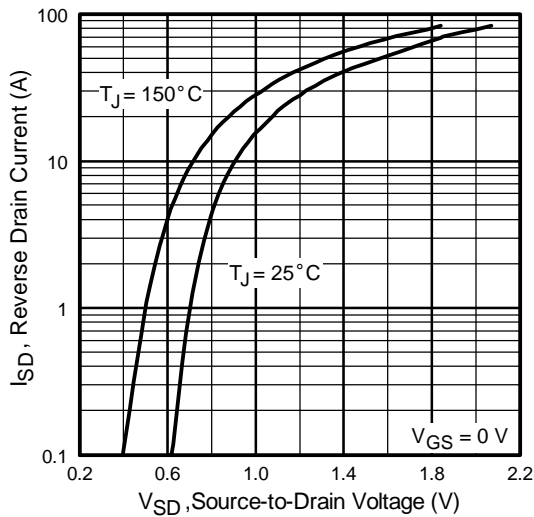

Fig 7. Typical Source-Drain Diode Forward Voltage

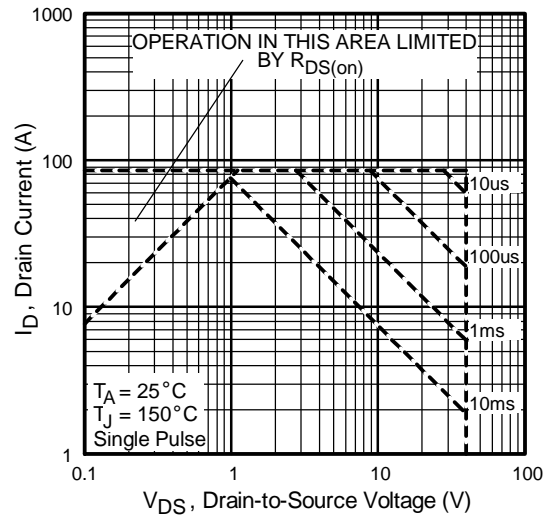

Fig 8. Maximum Safe Operating Area

Fig 6. On-Resistance Vs. Drain Current

International
IR Rectifier

IRF7470PbF

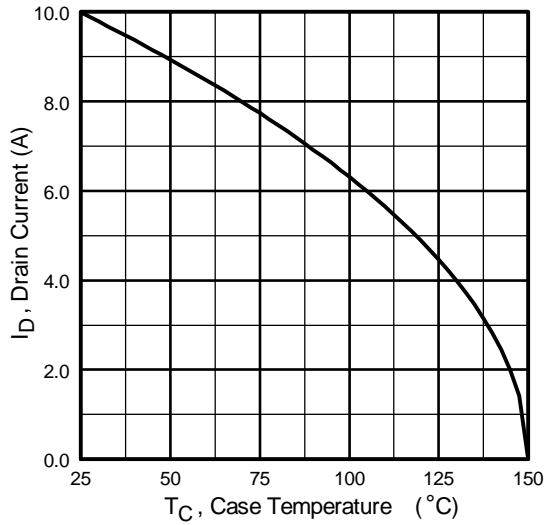

Fig 10a. Switching Time Test Circuit



Fig 10b. Switching Time Waveforms

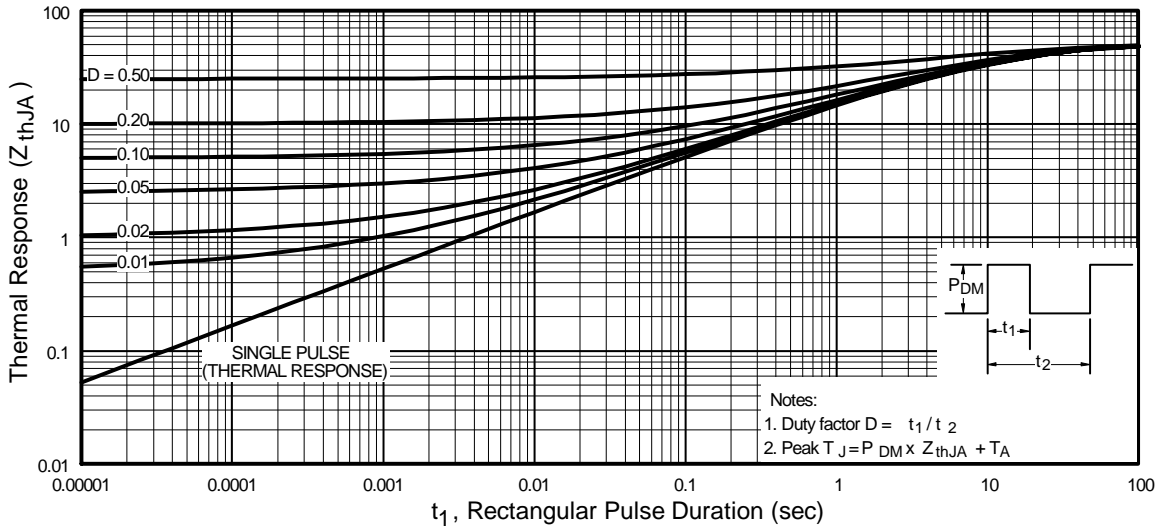

Fig 10. Maximum Effective Transient Thermal Impedance, Junction-to-Ambient

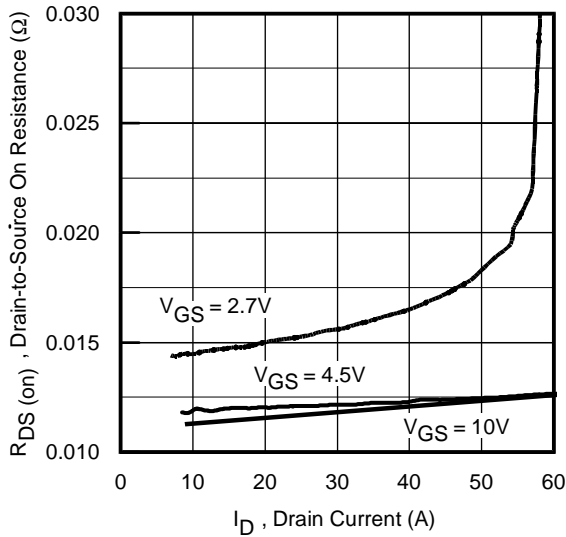

Fig 12. On-Resistance Vs. Drain Current

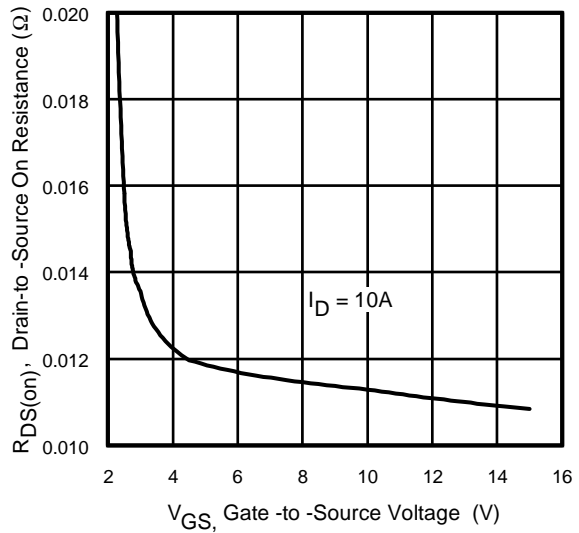

Fig 13. On-Resistance Vs. Gate Voltage



Fig 13a&b. Basic Gate Charge Test Circuit and Waveform

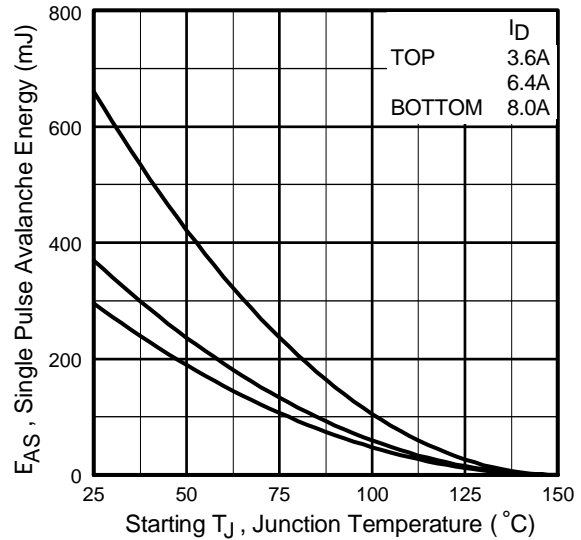

Fig 14c. Maximum Avalanche Energy Vs. Drain Current



Fig 14a&b. Unclamped Inductive Test circuit and Waveforms

SO-8 Package Outline

Dimensions are shown in millimeters (inches)

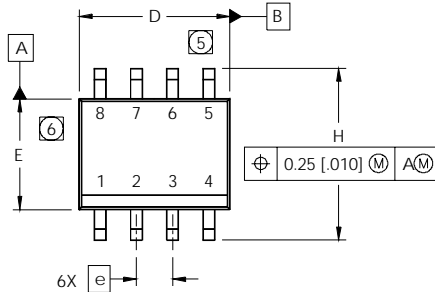

DIM	INCHES		MILLIMETERS	
	MIN	MAX	MIN	MAX
A	.0532	.0688	1.35	1.75
A1	.0040	.0098	0.10	0.25
b	.013	.020	0.33	0.51
c	.0075	.0098	0.19	0.25
D	.189	.1968	4.80	5.00
E	.1497	.1574	3.80	4.00
e	.050 BASIC		1.27 BASIC	
e1	.025 BASIC		0.635 BASIC	
H	.2284	.2440	5.80	6.20
K	.0099	.0196	0.25	0.50
L	.016	.050	0.40	1.27
y	0°	8°	0°	8°

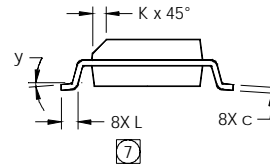
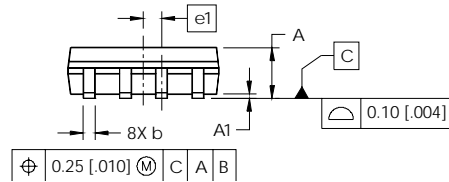

NOTES:

1. DIMENSIONING & TOLERANCING PER ASME Y14.5M-1994.
2. CONTROLLING DIMENSION: MILLIMETER
3. DIMENSIONS ARE SHOWN IN MILLIMETERS [INCHES].
4. OUTLINE CONFORMS TO JEDEC OUTLINE MS-012AA.
- ⑤ DIMENSION DOES NOT INCLUDE MOLD PROTRUSIONS. MOLD PROTRUSIONS NOT TO EXCEED 0.15 [.006].
- ⑥ DIMENSION DOES NOT INCLUDE MOLD PROTRUSIONS. MOLD PROTRUSIONS NOT TO EXCEED 0.25 [.010].
- ⑦ DIMENSION IS THE LENGTH OF LEAD FOR SOLDERING TO A SUBSTRATE.

FOOTPRINT

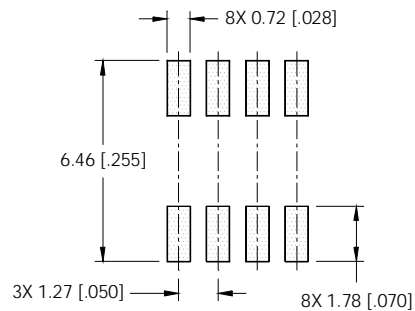

SO-8 Part Marking

EXAMPLE: THIS IS AN IRF7101 (MOSFET)

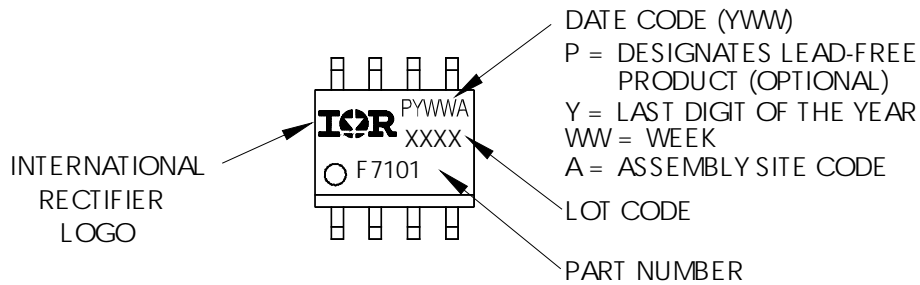

IRF7470PbF

SO-8 Tape and Reel

Dimensions are shown in millimeters (inches)

International
IR Rectifier

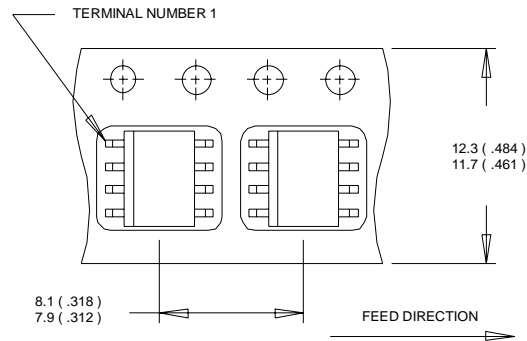

NOTES:

1. CONTROLLING DIMENSION : MILLIMETER.
2. ALL DIMENSIONS ARE SHOWN IN MILLIMETERS(INCHES).
3. OUTLINE CONFORMS TO EIA-481 & EIA-541.

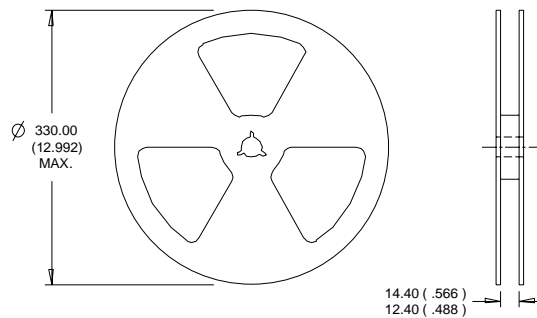

NOTES:

1. CONTROLLING DIMENSION : MILLIMETER.
2. OUTLINE CONFORMS TO EIA-481 & EIA-541.

Notes:

- ① Repetitive rating; pulse width limited by max. junction temperature.
- ② Starting $T_J = 25^\circ\text{C}$, $L = 9.4\text{mH}$
 $R_G = 25\Omega$, $I_{AS} = 8.0\text{A}$.
- ③ Pulse width $\leq 400\mu\text{s}$; duty cycle $\leq 2\%$.
- ④ When mounted on 1 inch square copper board, $t < 10$ sec

Data and specifications subject to change without notice.
This product has been designed and qualified for the Consumer market.
Qualifications Standards can be found on IR's Web site.

International
IR Rectifier

IR WORLD HEADQUARTERS: 233 Kansas St., El Segundo, California 90245, USA Tel: (310) 252-7105
TAC Fax: (310) 252-7903

Visit us at www.irf.com for sales contact information.08/04

www.irf.com

Mouser Electronics

Authorized Distributor

Click to View Pricing, Inventory, Delivery & Lifecycle Information:

[Infineon:](#)

[IRF7470PBF](#) [IRF7470TRPBF](#)